

# HOOVER



**HOBBS**

*USER INSTRUCTIONS*

**GB**



<b>CONTENT</b>	<b>GB</b>
----------------	-----------

1. General warnings .....	6
2. Installation .....	6
3. Built-in.....	6
4. Electrical connection.....	6
5. Presentation.....	7
6. Hob cookware advice .....	7
7. Use .....	8
8. Maintenance and cleaning .....	9
9. Problem solving.....	10
10. Aftercare .....	10
11. Protection of the environment.....	10

# A Identification Plate (located under the hob's bottom casing)

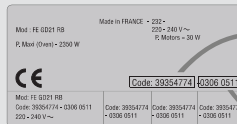

Product code / Code produit

Code produit : .....  
Numéro de série : .....

Sérial n° / Numéro de série

# B

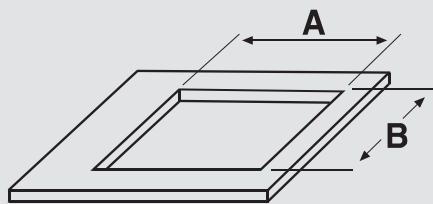

**60 cm**

A = 560

B = 490

**75 cm**

A = 740

B = 490

# C

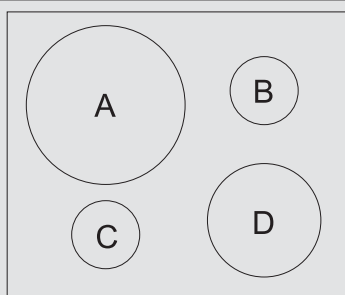

LAYOUT 1

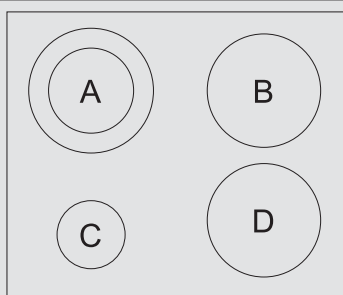

LAYOUT 2

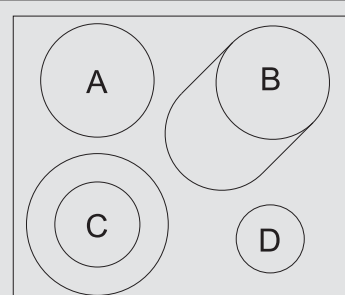

LAYOUT 3

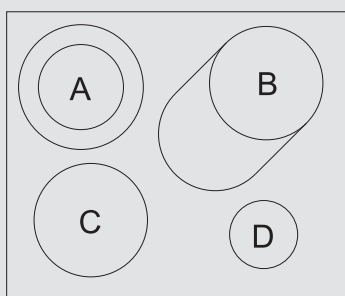

LAYOUT 4

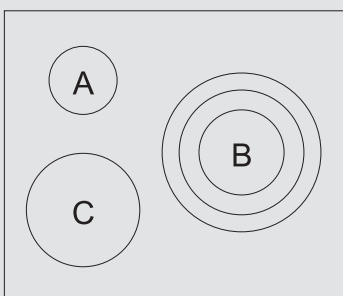

LAYOUT 5

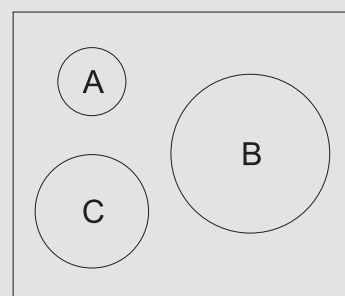

LAYOUT 6

	A	B	C	D
LAYOUT 1	2300 W	1200 W	1200 W	1800 W
LAYOUT 2	1450+750 W	1800 W	1200 W	1800 W
LAYOUT 3	1800 W	1500+900 W	1100+600 W	1200 W
LAYOUT 4	1450+750 W	1500+900 W	1800 W	1200 W
LAYOUT 5	1200 W	1500 + 750 W	1800 W	—
LAYOUT 6	1200 W	2500 W	1800 W	—

D

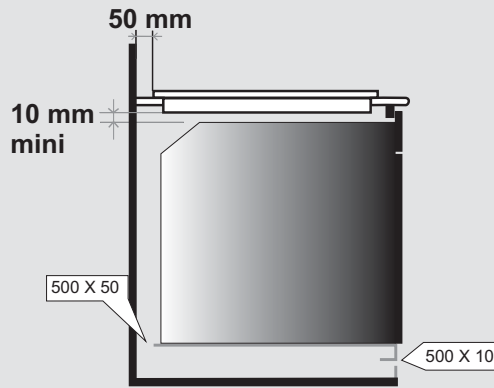
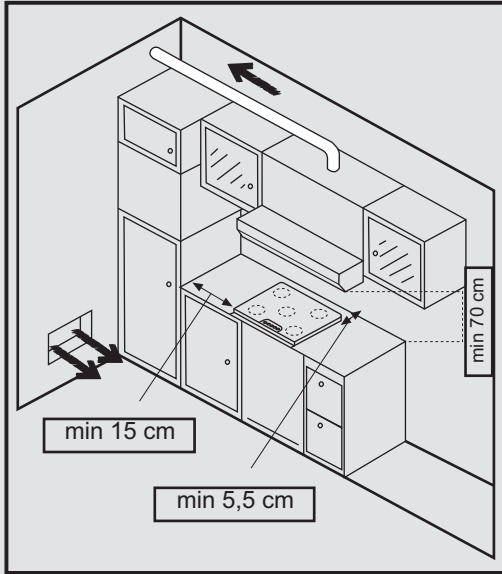
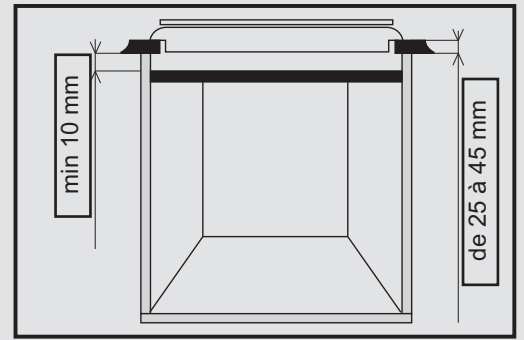
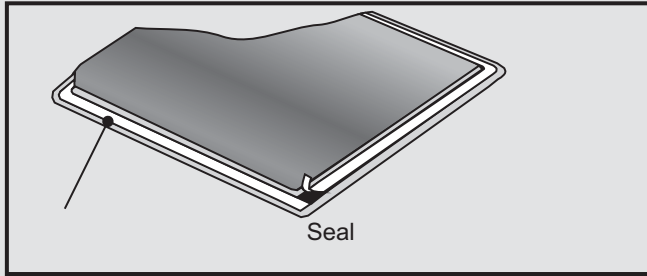

It is forbidden to fit the hob above a non-ventilated oven.

E

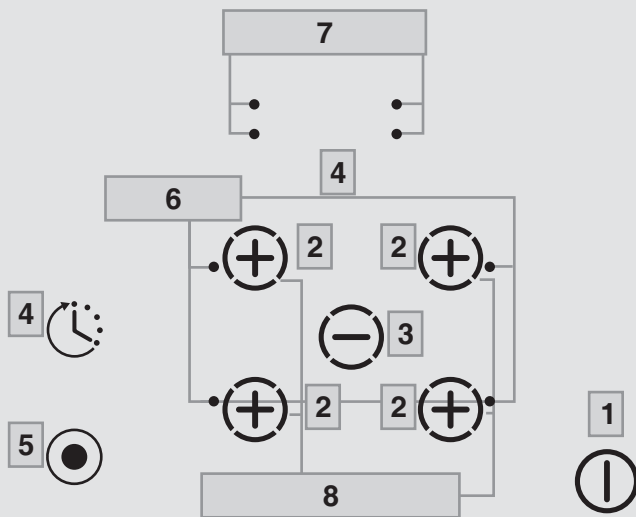

According to model

1. ON / OFF
2. " + "
3. " - "
4. TIMER
5. Additional cooking
6. Additional cooking zone led
7. Cooking zone programming indicator
8. Control Led

# 1. GENERAL WARNINGS

READ THE INSTRUCTIONS BOOKLET CAREFULLY TO MAKE THE MOST OF YOUR HOB.

We recommend you keep the instructions for installation and use for later reference, and before installing the hob, note its serial number in case you need to get help from the after sales service.

- It is strongly recommended to keep children away from the cooking zones while they are in operation or when they are switched off, so long as the residual heat indicator is on, in order to prevent the risks of serious burns.
  - When cooking with fats or oils, take care always to watch the cooking process as heated fats and oils can catch fire rapidly.
  - Aluminium foil and plastic pans must not be placed on heating zones.
  - After every use, some cleaning of the hob is necessary to prevent the build up of dirt and grease. If left, this is recooked when the hob is used and burns giving off smoke and unpleasant smells, not to mention the risks of fire propagation.
  - It is advisable not to stare directly at the halogen elements.
  - Do not touch the heat zones during operation or for a while after use.
  - Never cook food directly on the glass ceramic hob. Always use the appropriate cookware.
  - Always place the pan in the centre of the unit that you are cooking on.
  - Do not use the surface as a cutting board.
  - Do not slide cookware across the hob.
  - Do not store heavy items above the hob. If they drop onto the hob, they may cause damage.
  - Do not use the hob as a working surface.
  - Do not use the hob for storage of any items.
  - In the unlikely event of a surface crack appearing, do not use the hob. Immediately disconnect the hob from the electrical power supply and call the After Sales Service
  - Never use a steam or high pressure spray to clean the appliance.
  - This appliance is not intended for use by persons (including children) with reduced physical, sensory or mental capabilities, or lack of experience and knowledge, unless they have been given supervision or instruction concerning use of the appliance by a person responsible for their safety.
  - Children should be supervised to ensure that they do not play with the appliance.
  - If present, do not to stare into halogen lamp hob elements.
  - This appliance is not intended to be operated by means of an external timer or separate remote-control system.
- CAUTION:** In order to avoid a hazard due to inadvertent resetting of the thermal cutout, this appliance must not be supplied through an external switching device, such as a timer, or connected to a circuit that is regularly switched on and off by the utility.
- Children under 8 Year of age must be kept away from the appliance unless they are continuously supervised.
  - This appliance can be used by children aged from 8 years and above and persons with reduced physical, sensory or mental capabilities or lack of experience and knowledge if they have been given supervision or instruction concerning use of the appliance in a safe way and understand the hazards involved.
  - Children must not play with the appliance.
  - NEVER try to extinguish a fire with water, but switch off the appliance and then cover flame e.g. with a lid or a fire blanket.
  - **WARNING:** Unattended cooking on a hob with fat or oil can be dangerous and may result in fire.
  - **WARNING:** Danger of fire: do not store items on the cooking surfaces.
  - **WARNING:** If the surface is cracked, switch off the appliance to avoid the possibility of electric shock.
  - **WARNING:** The appliance and its accessible parts become hot during use. Care should be taken to avoid touching heating elements.

We are constantly striving to improve product quality and as such may modify appliances to incorporate the latest technical improvements.

 Appliance complies with European Directives 73/23/EEC and 89/336/EEC, replaced by 2006/95/EC and 2004/108/EC, and subsequent amendments.

## 2. INSTALLATION

**Installing a domestic appliance can be a complicated operation which if not carried out correctly, can seriously affect consumer safety. It is for this reason that the task should be undertaken by a professionally qualified person who will carry it out in accordance with the technical regulations in force. In the event that this advice is ignored and the installation is carried out by an unqualified person, the manufacturer declines all responsibility for any technical failure of the product whether or not it results in damage to goods or injury to individuals.**

## 3. BUILT-IN

The furniture in which your hob will be installed and all adjacent furniture, should be made from materials that can withstand high temperatures. In addition, all decorative laminates should be fixed with heat-resistant glue.

**Installation (Fig. B / D):**

- A watertight seal is supplied with the hob.

**Before fitting:**

- Turn the hob upside down, with the glass surface facing downwards.  
**Make sure the glass is protected.**
  - Fit the seal round the hob.
  - Make sure that it is correctly fitted to avoid any leakage into the supporting cabinet.
- Leave a gap of at least 5 cm between the appliance and the vertical sides of the adjacent furniture.
  - If, when installing the hob, the lower hob face is adjacent to an area normally accessible when handling or cleaning, fit a partition 1 cm below the base of the hob to avoid any risk of scorching or damage.

## 4. ELECTRICAL CONNECTION

"The installation must conform to the standard directives."

The manufacturer declines all responsibility for any damage that may be caused by unsuitable or unreasonable use.

**Warning:**

**we cannot be held responsible for any incident or its consequences that may arise during the use of an appliance not linked to the earth, or linked to an earth whose continuity is defective.**

- Always check before any electrical operation, the supply tension shown on the electricity meter, the adjustment of the circuit-breaker, the continuity of the connection to earth to the installation and that the fuse is suitable.

- The electrical connection to the installation should be made via a socket with a plug with earth, or via an omnipole cut-out switch.

*If the appliance has a socket outlet, it must be installed so that the socket outlet is accessible.*

- The yellow/green wire of the power supply cable must be connected to the earth of both power supply and appliance terminals.
- Any queries regarding the power supply cord should be referred to After Sales Service or a qualified technician.

**ATTENTION:**

Should it be necessary to replace the supply cord, connect the wire in accordance with the following colours/codes:

<b>BLUE</b>	- NEUTRAL (N)
<b>BROWN</b>	- LIVE (L)
<b>YELLOW-GREEN</b>	- EARTH (⊕)

The hob is fitted with a power supply cord which allows it to be connected only to a power supply of 220-240 V between phases or between phase and neutral.

• **Connect to a socket, to choose the correct fuse, you must refer on the table.**

It is however possible to connect the hob to :

- . Three phase 220-240 V3~
- . Three phase 380-415 V2N~

**To proceed to the new connection, you must adhere the following instructions.**

• Before making the connection, make sure that the installation is protected by a suitable fuse, see table, and that it is fitted with wires of a large enough section to supply the appliance normally.

• Turn over the hob, glass side against the work top, taking care to protect the glass.

• **Open the cover in the following sequence:**

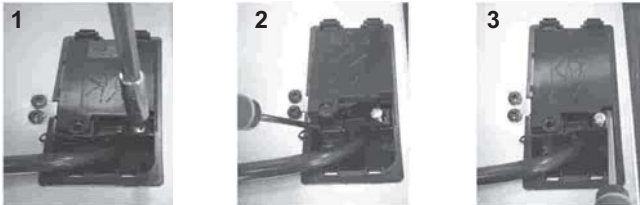

- Unscrew the cable clamp "1",
- Find the two tabs located on the sides,
- Put the blade of a flat screw-driver in front of each tab "2" e "3", push in and press,
- Remove the cover.

**To release the power supplying cord.**

- Remove the screws retaining the terminal block which contains the shunt bars and the conductors of the supply cord,
- Pull out the supply cord.

• **Operations to be carried out to make a new connection :**

- Choose the power supply cable in accordance with the recommendations in the table.
- Pass the power supply cable into the clamp.

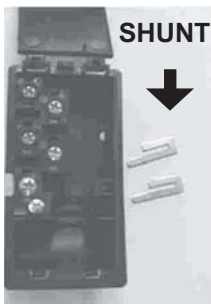

- Strip the end of each conductor of the supply cord on a 10 mm length, by taking in account the requested length of the cord for the connection to the terminal block.
- According to the installation and with the help of shunt bars which you should have recovered in the first operation, fix the conductor as shown on the chart.
- Fix the cover.
- Screw the cable clamp.

**Note:** make sure the terminal board screws are tight.

• The instructions state the type of cord to be used, taking into account the temperature of the rear surface of the appliance.

## Connection to the terminals on the terminal block

	LAY OUT " 5 "	LAY OUT " 2 - 3 "	LAY OUT " 4 "	LAY OUT " 1 "
MONOPHASE or TWO PHASES 220-240 V~				
Fuse	25 A	25 A	25 A	20 A
Cable HO5V2V2F	3x2,5mm <sup>2</sup>	3x2,5mm <sup>2</sup>	3x2,5mm <sup>2</sup>	3x2,5mm <sup>2</sup>
THREE PHASES 220-240 V3~				
Fuse	25 A	20 A	25 A	20 A
Cable HO5V2V2F	4x2,5mm <sup>2</sup>	4x2,5mm <sup>2</sup>	4x2,5mm <sup>2</sup>	4x2,5mm <sup>2</sup>
THREE PHASES 380-415 V2N~				
Fuse	16 A	20 A	20 A	16 A
Cable HO5V2V2F	4x1,5mm <sup>2</sup>	4x2,5mm <sup>2</sup>	4x2,5mm <sup>2</sup>	4x1,5mm <sup>2</sup>

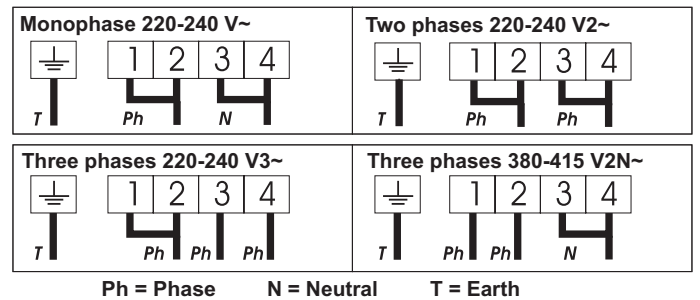

## 5. PRESENTATION

• **Hiligt zone :**

A metallic conductor strip is spread uniformly over the whole surface unit. It is effective within 3 seconds and is suitable for steady, homogeneous and also sustained cooking.

The glass-ceramic hob benefits from greater heat output which is generated by the highlight cooking zones thereby accelerating the cooking process. Modifications to the design of the hob have not affected the capacity of the glass to withstand high temperatures, but they have improved controllability.

With the "Sprinter" facility, reduced cooking times of up to 15% can be achieved, depending upon the method of cooking and the type of saucepans being used.

## 6. HOB COOKWARE ADVICE

Using good quality cookware is critical for setting the best performance from your hob.



• **Always use good quality cookware with perfectly flat and thick bases :**

using this type of cookware will prevent hot spots that cause food to stick. Thick metal pots and pans will provide an even distribution of heat.

• **Ensure that the base of the pot or pan is dry :** when filling pans with liquid or using one that has been stored in the refrigerator, ensure that the base of the pan is completely dry before placing it on the hob. This will help to avoid staining the hob.

• **Use pans whose diameter is wide enough to completely cover the surface unit :** the size of the pan should be no smaller than the heating area. If it is slightly wider the energy will be used at its maximum efficiency.

**THE CHOICE OF COOKWARE** - The following information will help you to choose cookware which will give good performance.

**Stainless Steel** : *Highly recommended.* Especially good with a sandwich clad base. The sandwich base combines the benefits of stainless steel (appearance, durability and stability) with the advantages of aluminium or copper (heat conduction, even heat distribution).

**Aluminium** : *Heavy weight recommended.* Good conductivity. Aluminium residues sometimes appear as scratches on the hob, but can be removed if cleaned immediately. Because of its low melting point, thin aluminium should not be used.

**Cast Iron** : *Usable, but not recommended.* Poor performance. May scratch the surface.

**Copper Bottom / stoneware**: *Heavy weight recommended.* Good performance, but copper may leave residues which can appear as scratches. The residues can be removed, as long as the hob is cleaned immediately. However, do not let these pots boil dry. Overheated metal can bond to glass hobs. An overheated copper pot will leave a residue that will permanently stain the hob.



**Porcelain/enamel** : Good performance only with a thin smooth, flat base.

**Glass-ceramic** : *Not recommended.* Poor performance. May scratch the surface.

• GENERAL STOP

The cooking zones and the timer can be stopped at any moment by pressing the On-Off button. 

• RESIDUAL HEAT INDICATOR

The control panel tells the user when the surface temperature of the cooking zones exceeds about 60°C, by the following displaying: . When the temperature goes back below 60°C, the  display goes off.

*For ending the cooking, we advise switching off the cooking zone and using the residual heat of the zone to finish cooking gently.*

N.B. After a cut in the current, the residual heat indicator disappears completely, even if the surface temperature exceeds 60°C.

• OPERATING THE ADDITIONAL COOKING ZONE (TWO ZONES)

The cooking zone with two zones is fitted certain models. It can be either concentric or extendable.

*It is active in totality when the cooking zone is in function ; the control led of the additional cooking is displayed.*

**To deactivate the additional cooking zone :**

- Press on the additional cooking zone button . The corresponding control led for the additional cooking zone goes off when it is deactivated.

**To re-activate the additional cooking zone :**

- Press on the additional cooking zone button . The corresponding control led for the additional cooking zone is active.

• OPERATING THE ADDITIONAL COOKING ZONE (THREE ZONES)

The additional cooking zone is fitted only one model.

*It is active in totality when the cooking zone is in function ; the two control leds of the additional cooking are displayed.*

**To deactivate the additional cooking zones :**

- Press one time the additional cooking zone button . The corresponding control led for the external additional cooking zone goes off when it is deactivated.

- Press two times the additional cooking zone button . The corresponding control led for the central additional cooking zone goes off when it is deactivated.

**To re-activate the additional cooking zones :**

- Press on the additional cooking zone button, one or two times on the additional cooking zone button, according to the need.

• PROGRAMMING A COOKING ZONE (according to the model)

Every cooking zone can be programmed for a maximum time of 99 minutes.

- Start the required zone by following the previous instructions. The control LED near the heat level must be displayed, it shows that the zone is live.

- Press the Timer button. 

*The zone mark around the timer display shows the controlled zone.*

- Press again on the timer button to select a time in minutes between 0 and 99 minutes or press on the "-" button to decrease the time between 60 minutes and 0.

→The programmed time can be modified at any moment reactivating the cooking zone and then the timer button.

When the time is run, the cooking zone goes off automatically and an audible beep sounds for 1 minute, press the timer button to stop it.

→The time can be used alone as reminder, it will ring at the end of the programmed time.

7. USE

• After powering up the hob, wait some seconds to activate the electronic controls.

- Press the button 

*Electronic control of the hob is activated. In each display zone the heat level  is displayed and the control LED blinks.*

- After 20 seconds without use, the electronic control goes off and the starting operation has to be repeated.

• STARTING A COOKING ZONE

- Press the selection button of the required cooking zone. In the display zone, the control LED is on steady. It shows that the zone is live.

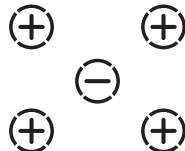



- Press the - or + button to select a heat level between 1 and 9. Hold down the + or - button and the heat level increases or decreases gradually.

*The following examples are for information only. Personal experience should then let you adapt these settings to your taste and habits.*

0	:	Off
1	:	)
2	:	)..... Melting heat
3	:	Keeping hot
4	:	Heating up
5	:	Thawing, stewing, full cooking, low temperature cooking
6	:	Cooking without lid
7	:	Frying, meat browning and roasting
8	:	High temperature cooking and roasting, seizing
9	:	Frying, boiling large quantities of water.....

• STOPPING A COOKING ZONE

- Press the selection button of the required cooking zone.

- Press the - button to display heat level . Now the zone goes off, the indicator  goes off after 10 seconds.

- To stop rapidly, press the - and + buttons at the same time. The heat level automatically goes down to . The cooking zone goes off.



## • LOCKING BUTTON OPERATION

The locking function prevents the children from starting the hob. It is also used for cleaning the control strip as the controls can be locked without the hob being on.

To lock the hob :

- Press the on/off button ①
- Press simultaneously " - " button and " + " button of the front right zone (CH 633 front left zone), and then press again on the " + " button of this zone. The hob is locked, the locking indicator " L " is displayed on all zones for 20 seconds.

To unlock the hob :

- Press the on/off button ① . The locking indicator " L " is displayed on all zones.
- Press simultaneously the " - " button and the " + " button of the front right zone (CH 633 front left zone), and then press again on the " - " button of this zone.  
The hob is unlocked.

## • FAST HEATER OPERATION

Starting the fast heater

- Press the on/off button ①
- Start the required zone, press the " + " button to obtain position "9", release the button briefly and press again the " + " button ; the display alternates showing "A" "fast heater" and "9" heat level.
- If necessary reduce to the required heat position, the display alternates showing "A" "fast heater" and the new heat position.

Cooking position	Power released (%)	Time of fast heater (minutes)	Maximum operating time before automatic cut off*
0	0 %	0	0 H
1	3 %	1	6 H
2	6 %	3	6 H
3	11 %	5	5 H
4	16 %	6,5	5 H
5	19 %	8,5	4 H
6	32 %	2,5	1,5 H
7	45 %	3,5	1,5 H
8	65 %	4,5	1,5 H
9	100 %	0	1,5 H

E.g. 1800 W zone at position 6 = 32% of 1800 W power released  
When the "Fast heater" is on, the zone supplies 1800 W power for 2.5 minutes, and adjusts to 576 W after this time.

\* For increased safety, the cooking zones cut off automatically if they are left on too long. The cut off depends on the heat level used.

To deactivate the fast heater

- Switch on the cooking zone, press the " - " button to come back to a normal heat level, decrease to the heat level required or to " 0 " to stop the cooking zone.

## 8. CLEANING AND MAINTENANCE

- Before carrying out any maintenance work on the hob, allow it to cool down.
- Only products, (creams and scrapers) specifically designed for glass ceramic surfaces should be used. They are obtainable from hardware stores.
- Avoid spillages, as anything which falls on to the hob surface will quickly burn and will make cleaning more difficult.
- It is advisable to keep away from the hob all substances which are liable to melt, such as plastic items, sugar, or sugar-based products.

MAINTENANCE:

- Place a few drops of the specialised cleaning product on the hob surface.
- Rub any stubborn stains with a soft cloth or with slightly damp kitchen paper.
- Wipe with a soft cloth or dry kitchen paper until the surface is clean.

If there are still some stubborn stains:

- Place a few more drops of specialised cleaning fluid on the surface.
- Scrape with a scraper, holding it at an angle of 30° to the hob, until the stains disappear.
- Wipe with a soft cloth or dry kitchen paper until the surface is clean.
- Repeat the operation if necessary.

A FEW HINTS:

Frequent cleaning leaves a protective layer which is essential to prevent scratches and wear. Make sure that the surface is clean before using the hob again. To remove marks left by water, use a few drops of white vinegar or lemon juice. Then wipe with absorbent paper and a few drops of specialised cleaning fluid. The control knobs can be removed for a complete cleaning. **However, you must care not to let any liquid go into the open zones, and then to push the knobs fully on fitting back.** The glass ceramic surface will withstand scraping from flat-bottomed cooking vessels, however, it is always better to lift them when moving them from one zone to another.

NB:

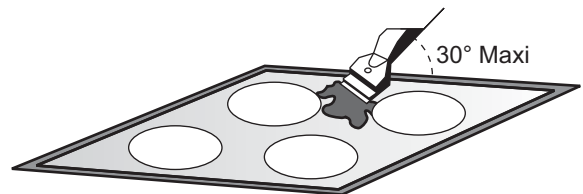

**Do not use a sponge which is too wet.**

**Never use a knife or a screwdriver.**

**A scraper with a razor blade will not damage the surface, as long as it is kept at an angle of 30°.**

**Never leave a scraper with a razor blade within the reach of children.**

**Never use abrasive products or scouring powders.**

- **The metal surround :** to safely clean the metal surround wash with soap and water, rinse, then dry with a soft cloth.
- Do not use a steam cleaner for cleaning operations
- Any spillage should be removed from the lid before opening.

## 9. PROBLEM SOLVING

*The cooking zones do not simmer or only fry gently*

- Only use flat-bottomed pans. If light is visible between the pan and the hob, the zone is not transmitting heat correctly.
- The pan bottom should fully cover the diameter of the selected zone.

*The cooking is too slow*

- Unsuitable pans are being used. Only use flat-bottomed utensils, that are heavy and have a diameter at least the same as the cooking zone.

*Small scratches or abrasions on the hob's glass surface*

- Incorrect cleaning or rough-bottomed pans are used; particles like grains of sand or salt get between the hob and the bottom of the pan. Refer to the "CLEANING" section; make sure that pan bottoms are clean before use and only use smooth bottomed pans. Scratches can be lessened only the cleaning is done correctly.

*Metal marks*

- Do not slide aluminium pans on the hob. Refer to the cleaning recommendations.
- You use the correct materials, but the stains persist. Use a razor blade and follow the "CLEANING" section.

*Dark stains*

- Use a razor blade and follow the "CLEANING" section.

*Light surfaces on the hob*

- Marks from an aluminium or copper pan, but also mineral, water or food deposits; they can be removed using the cream cleaner.

*Caramelisation or melted plastic on the hob.*

- Refer to the "CLEANING" section.

*The hob does not operate or certain zones don't work*

- The shunts are not positioned correctly on the terminal board. Have a check made that the connection is done in compliance with the recommendations.
- Hobs with sensitive controls: a big spill or object covers at least two buttons, for at least 10 seconds. Clean up the spill or remove the object.
- The control panel is locked. Unlock the hob.

*The hob does not cut off.*

- The control panel is locked. Unlock the hob.

*The hob stops automatically*

- A spill covers at least two buttons for more than 10 seconds; the hob switches to safety, and an audible beep sounds. Clean up the spill or remove the object.
- The cooking zones stop automatically if they are left on for too long. Refer to the section, "operating time".

*Frequency of on/off operations for cooking zones*

- The on-off cycles vary according to the required heat level:
  - low level: short operating time,
  - high level: long operating time.

*"H" display, residual heat indicator, blinking.*

- The electronic temperature is too high. A technician should verify the fitting in compliance with the recommendations.

- For appliances with type X attachment:

If the supply cord is damaged, it must be replaced by a special cord or assembly available from the manufacturer or its service agent.

- For appliances with type Y:

If the supply cord is damaged, it must be replaced by the manufacturer, its service agent or similarly qualified persons in order to avoid a hazard.

- For appliances with type Z attachment:

The supply cord cannot be replaced. If the cord is damaged the appliance should be scrapped.

## 10. AFTERCARE

**Before calling out a Service Engineer please check the following:**

— that the plug is correctly inserted and fused;  
— If the fault cannot be identified switch off the appliance — do not tamper with it — call the Aftercare Service Centre. The appliance is supplied with a guarantee certificate that ensures that it will be repaired free of charge at the Service Centre.

## 11. PROTECTION OF THE ENVIRONMENT



This appliance is marked according to the European directive 2002/96/EC on Waste Electrical and Electronic Equipment (WEEE). By ensuring this product is disposed of correctly, you will help prevent potential negative consequences for the environment and human health, which could otherwise be caused by inappropriate waste handling of this product. The symbol on the product indicates that this product may not be treated as household waste.

Instead it shall be handed over to the applicable collection point for the recycling of electrical and electronic equipment. Disposal must be carried out in accordance with local environmental regulations for waste disposal.

For more detailed information about treatment, recovery and recycling of this product, please contact your local city office, your household waste disposal service or the shop where you purchased the product.



