

Tolga - Bookcase

Assembly Instructions - Please keep for future reference

497/2309

481/9637

496/0885

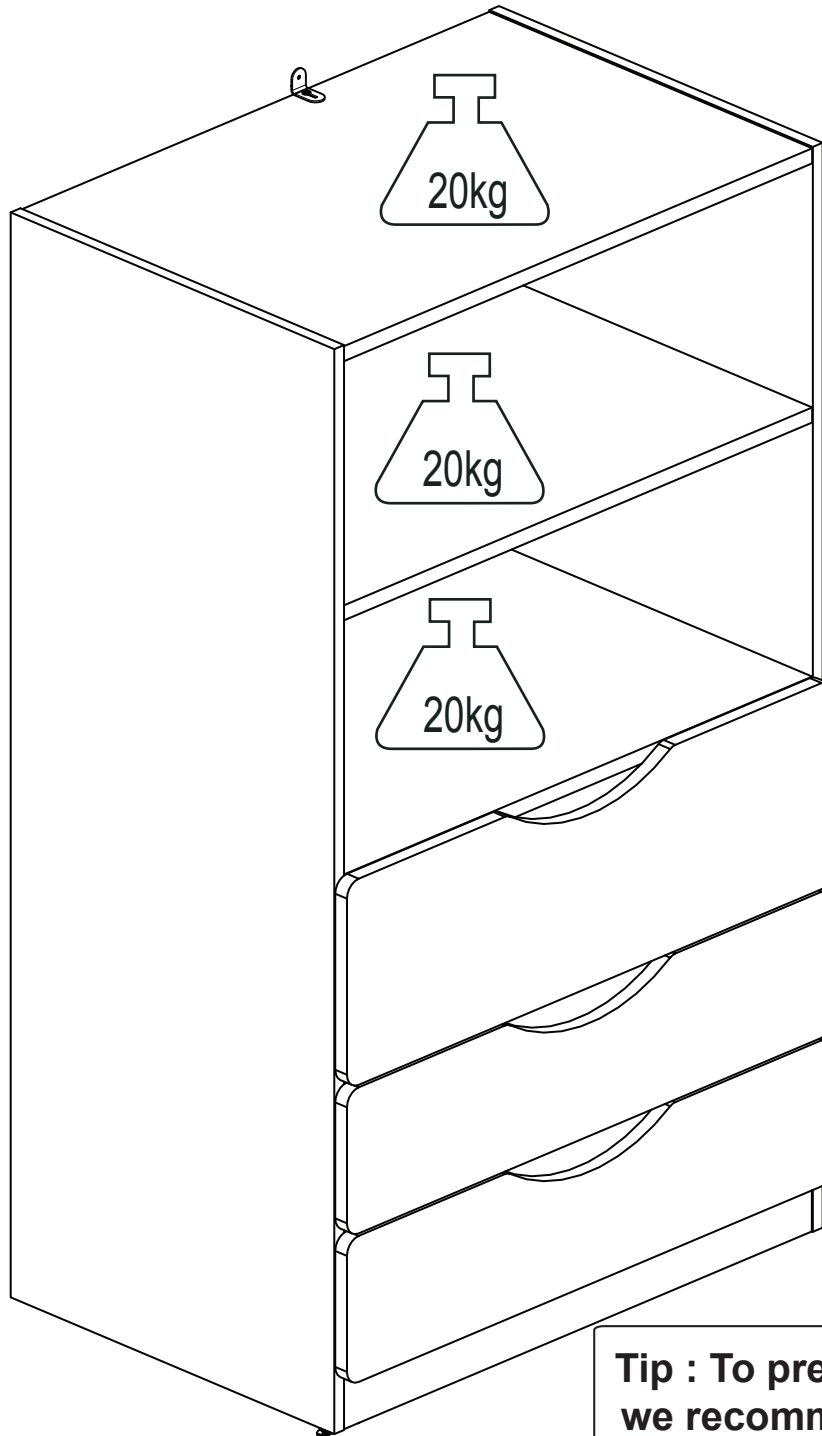

Dimensions

Width - 75cm
Depth - 51,75cm
Height - 130cm

497/2309 BLUE
481/9637 OAK
496/0885 PINK

Tip : To prevent damage, we recommend that you build your unit on the carton(s) it was packed in.

Important – Please read these instructions fully before starting assembly

If you need help or have damaged or missing parts, please visit: www.argos-support.co.uk
or email: Help@ClickSpares.co.uk (quoting your original order number)
Alternatively, call the Spares Helpline on: **0370 112 1928**
For any other queries please contact the Customer Helpline on: **0345 640 2020**



Safety and Care Advice

Important – Please read these instructions fully before starting assembly

- Check you have all the components and tools listed on the following pages.
 - Remove all fittings from the plastic bags and separate them into their groups.
 - Keep children and animals away from the work area, small parts could choke if swallowed.
 - Make sure you have enough space to layout the parts before starting.
 - During assembly do not stand or put weight on the product, this could cause damage.
 - Assemble the item as close to its final position (in the same room) as possible.
 - Assemble on a soft level surface to avoid damaging the unit or your floor.
 - Parts of the assembly will be easier with 2 people.
- 
- To reduce the likelihood of damaging your product please ensure that your power drill is set on a low torque setting.
 - Assembly should be carried out by a competent adult only.
 - do not use this item if any components are missing or damaged.
 - this item is suitable for children from the age of 6.

Glue safety - Take care when using glue, please follow the advice below•

Skin contact: Remove contamination by washing with soap and water. This procedure should also be followed prior to eating and drinking.

Eye contact: Rinse immediately with clean water for 15 minutes and seek medical advice.

If swallowed: Seek medical advice immediately.

Care and maintenance

• Only clean using a damp cloth and mild detergent, do not use bleach or abrasive cleaners.

• From time to time check that there are no loose screws on this unit.

• This product should not be discarded with household waste. Take to your local authority waste disposal centre.

Handy Hints

• Assemble all parts and bolts loosely during assembly, only once the product is complete should you fully tighten the bolts

• Regularly check and ensure that all bolts and fittings are tightened properly.

Note: if required the next page can be cut out and used as reference throughout the assembly. Keep this page with these instructions for future reference.

Components - Panels

For damaged or missing parts, please visit:
www.argos-support.co.uk or email: Help@ClickSpares.co.uk

Please check you have all the panels listed below

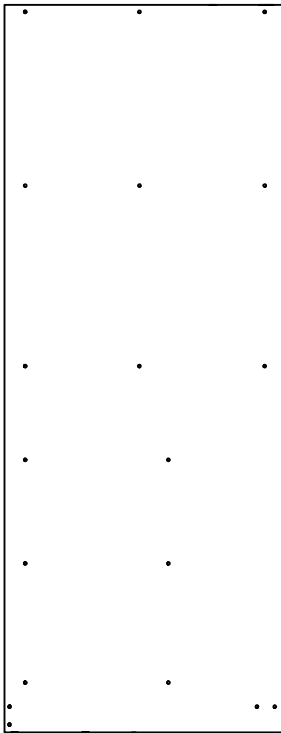

1 Left Side x 1
(1300 x 497 x 15mm)
P2061B

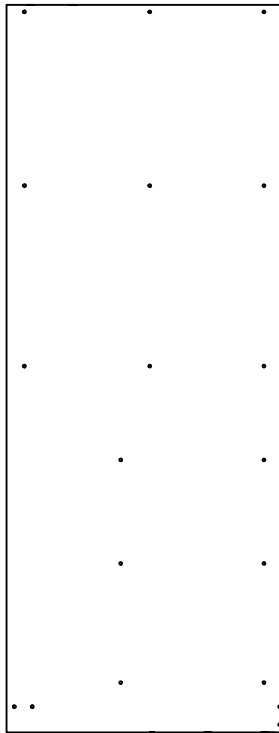

2 Right Side x 1
(1300 x 497 x 15mm)
P2054B

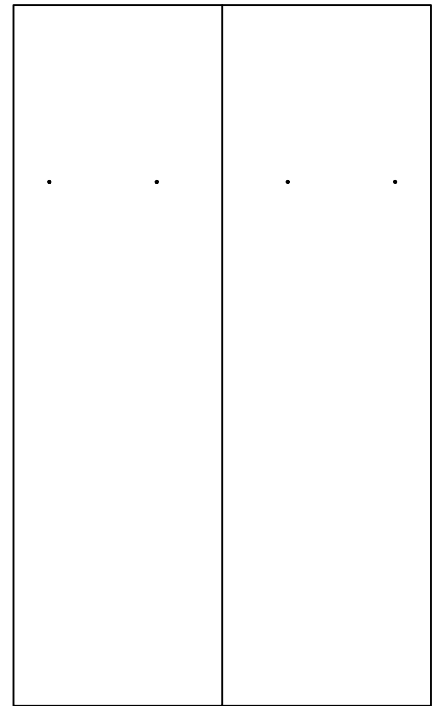

3 Back x 1
(1252 x 746 x 2.5mm)
BO2552

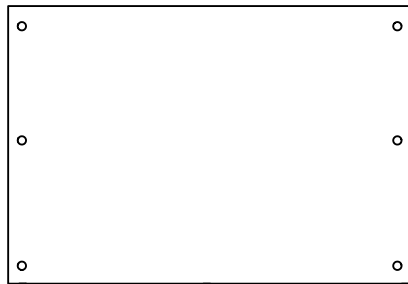

4 Top / Shelf x 3
(720 x 496 x 18mm)
P1487

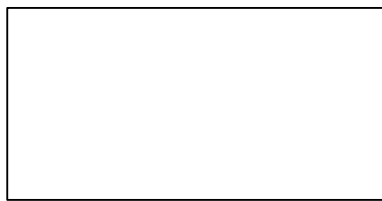

5 Drawer Base x 3
(681 x 343 x 2.5mm)
BO2540

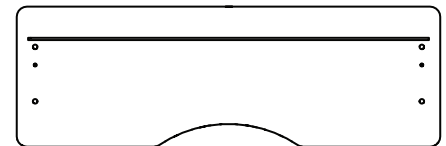

6 Drawer Front x 1
(747 x 247 x 18mm)
P4133

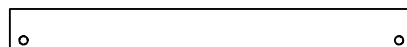

7 Plinth x 2
(720 x 140 x 12.5mm)
P7058

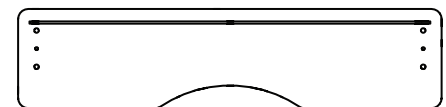

8 Drawer Front x 2
(747 x 175 x 18mm)
P4134

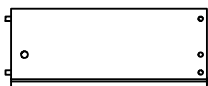

9 Left Drawer Side x 1
(350 x 140 x 12.5mm)
LA1614

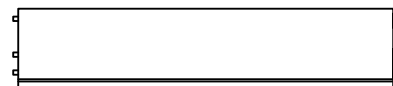

10 Drawer Back x 1
(670 x 140 x 12.5mm)
LA1617

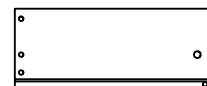

11 Right Drawer Side x 21
(350 x 140 x 12.5mm)
LA1615

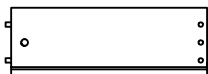

12 Left Drawer Side x 2
(350 x 120 x 12.5mm)
LA1624

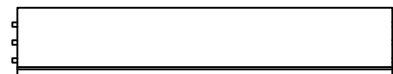

13 Drawer Back x 2
(670 x 120 x 12.5mm)
LA1619

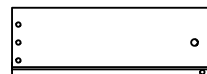

14 Right Drawer Side x 2
(350 x 120 x 12.5mm)
LA1625









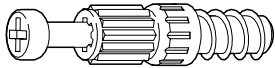

Components - Fittings

For damaged or missing parts, please visit: www.argos-support.co.uk or email: Help@ClickSpares.co.uk

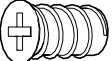
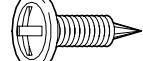
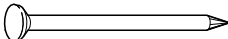
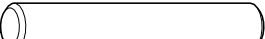
Please check you have all the fittings listed below

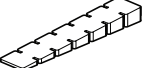
Note: The quantities below are the correct amount to complete the assembly. In some cases more fittings may be supplied than are required.

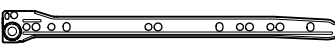
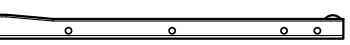
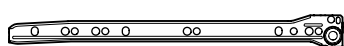
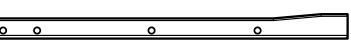
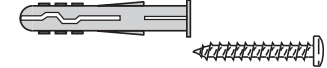
A  Locking screw x 28 (5x24mm)	B  Locking nut x 6 (12x10mm)	C  Large locking nut x 22 (15x12mm)
D  12.5mm Pozi screw x 42	E  10mm Fixing screw drawer x 12	F  Screw x 5 (4x15mm)
G  Nail x 60	H  Wood dowel x 4 (5x30mm)	I  Drawer base support x 18
J  L-Bracket x 1	K  Peg, brown x 1	L  Glue x 2
M  Nail holder x 1	N  Runner left part A x 3	O  Runner left part B x 3
P  Runner right part A x 3	Q  Runner right part B x 3	R  Wall plug (6mm) and parkerscrew x 1

Tools required

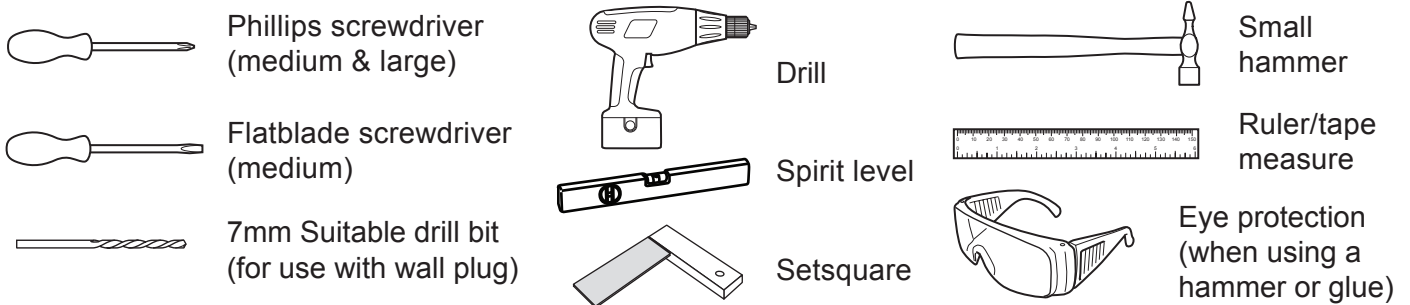

Ruler - Use this ruler to help correctly identify the screws



The screws length is measured from the head to the point (30mm screw shown).

Assembly Instructions

Step - 1

Insert large locking nuts **C** into plinth **7**.

2x

Make sure the 'arrow' on locking nuts **C** points towards the hole in the edge of **7**.

Put drop of glue **L** into the 2 holes of plinth **7**.

Put dowels **H** into the holes of plinth **7**.

Do this step twice

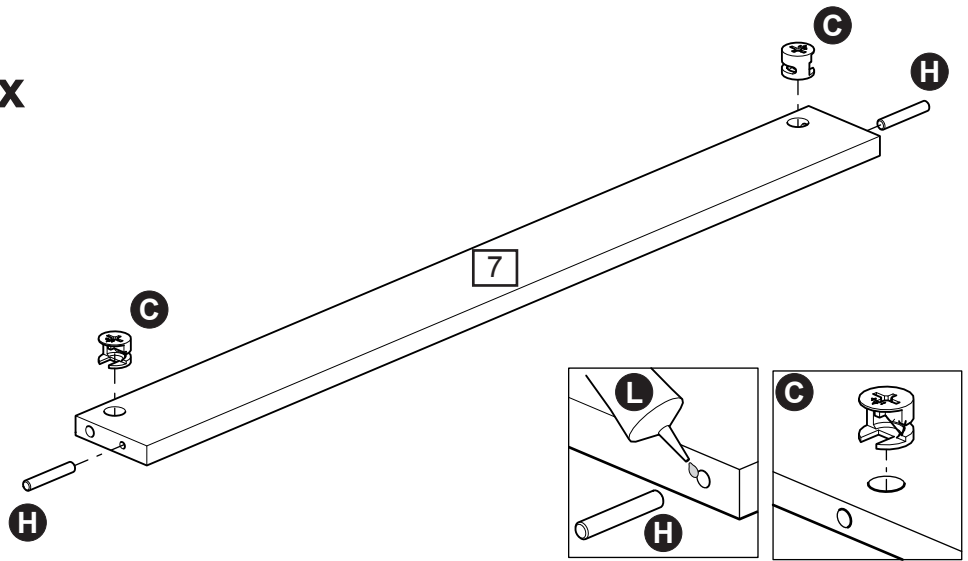

Step - 2

Attaching runners

a: Fix runner right part **A** (**P**) on right side **2** as shown using 10mm fixing screw drawer **E** into right side **2**.

Note: look careful for the right position.

Screw 24mm locking screw **A** into right side **2**.

Note: Insert 24mm locking screw **A** as far as shown. Do not over tighten.

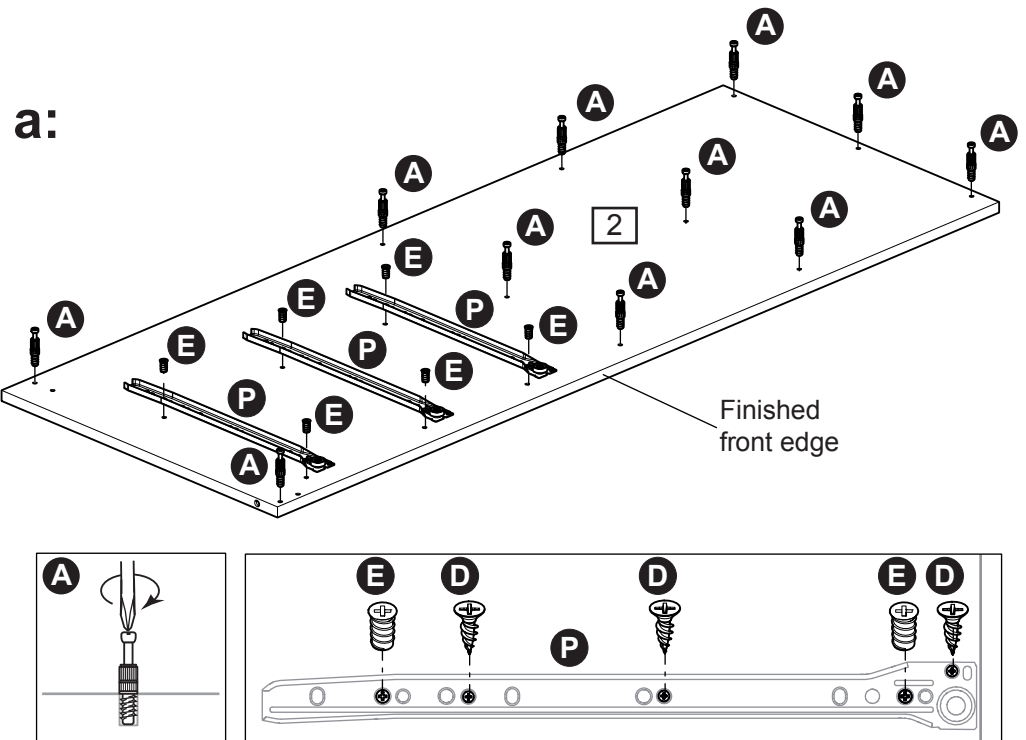

b: Insert 12,5mm pozi screw **D** as shown into right side the **2** to fix runner right part **A** (**P**).

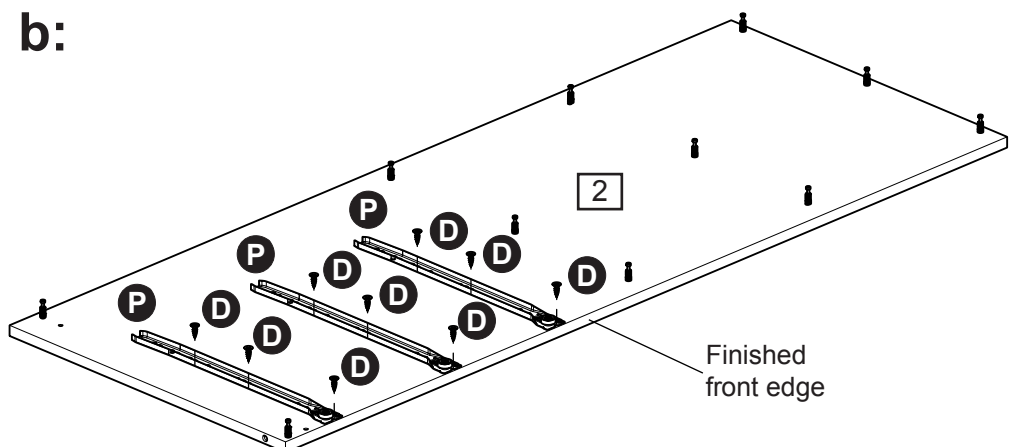

Assembly Instructions

Step - 3

Attaching runners

a: Fix runner leftpart A **N** on leftside **1** as shown using 10mm fixing screw drawer **E** into left side **1**.

Note: look carreful for the right postion.

Screw 24mm locking screw **A** into right side **1**.

Note: Insert 24mm locking screw **A** as far as shown. **Do not over tighten.**

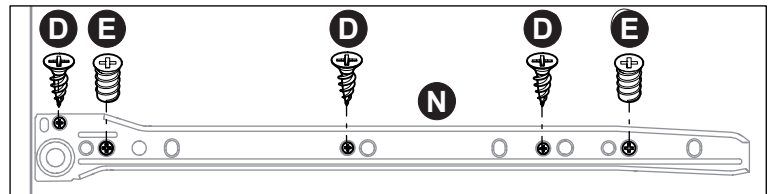
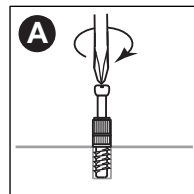
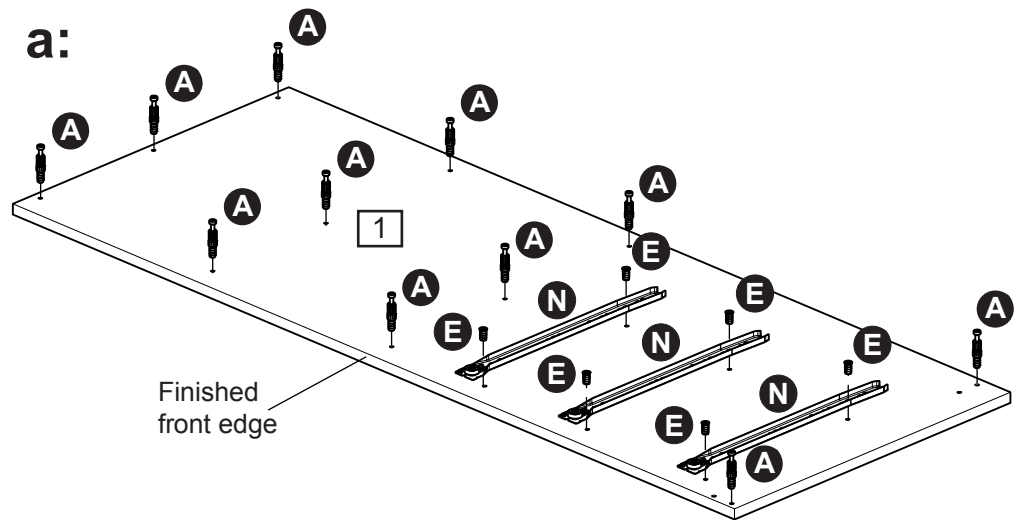

b: Insert 12,5mm pozi screw **D** as shown into right side the **1** to fix runner left part A **N**.

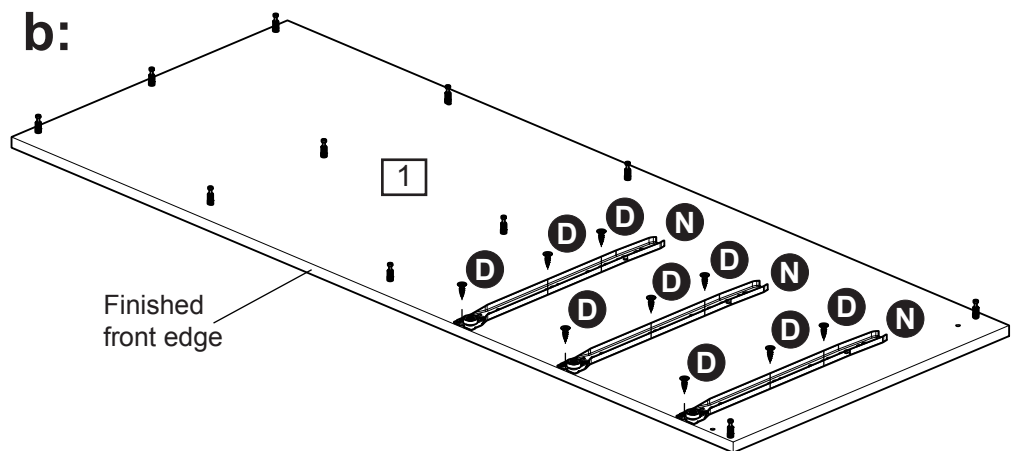

Step - 4

Insert large locking nuts **C** into top **4**.

Make sure the 'arrow' on locking nuts **C** points towards the hole in the edge of **4**.

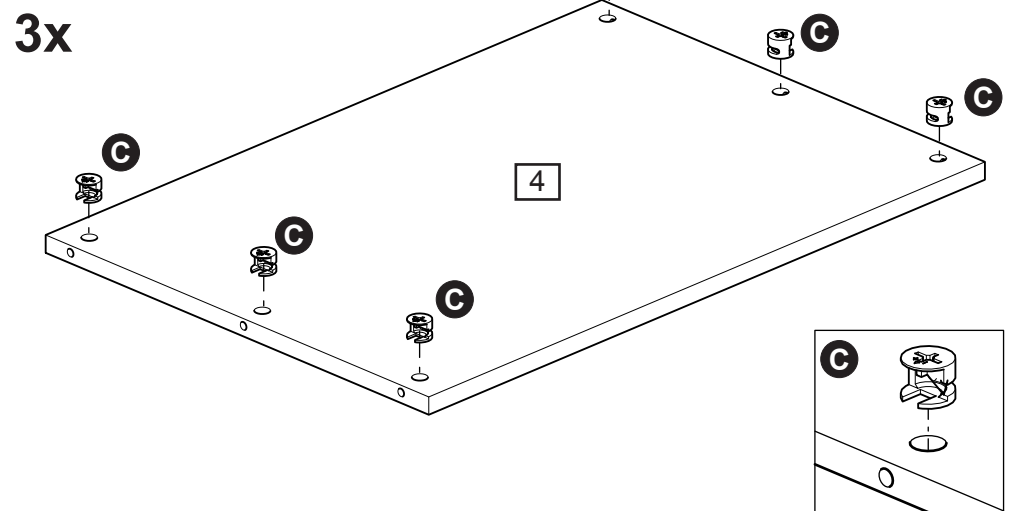

Assembly Instructions

Step - 5

Attaching panels

Put drop of glue **L** into the 2 holes of left side **1** and right side **2** on the bottom of the sides.

Position left side **1** and right side **2** onto plinth **7** and top / shelf **4**.

Use a screwdriver to turn locking nuts clockwise to lock.

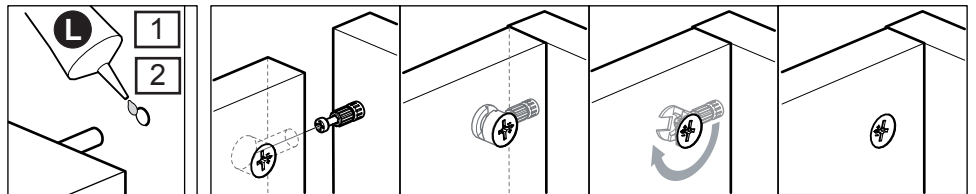
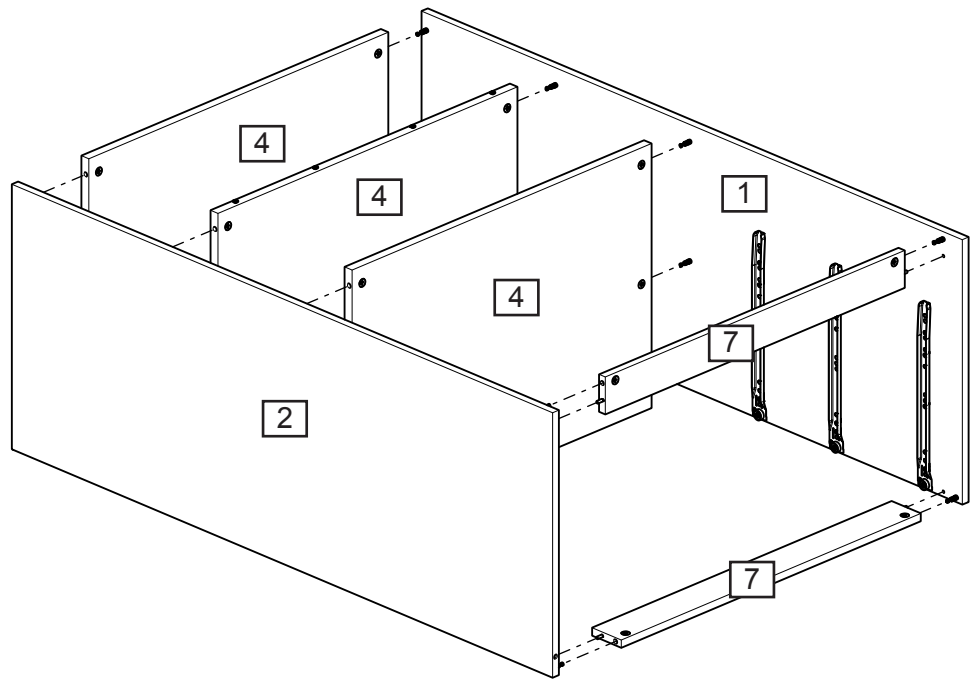

Step - 6

Fitting back panel

Attach back **3** to the back with the coloured surface facing the inside using nails **G**. Use nail holder **M** to hold the nails **G** vertical and at correct distance as you secure the back **3**. Nails **G** should be spaced about 150mm apart. Use screw **F** into the holes of back **3** to attach the shelf **6**.



Important:
Furniture **MUST** be 'square' when back is attached.

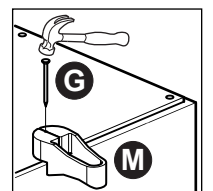
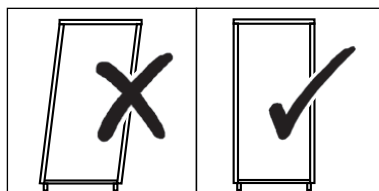
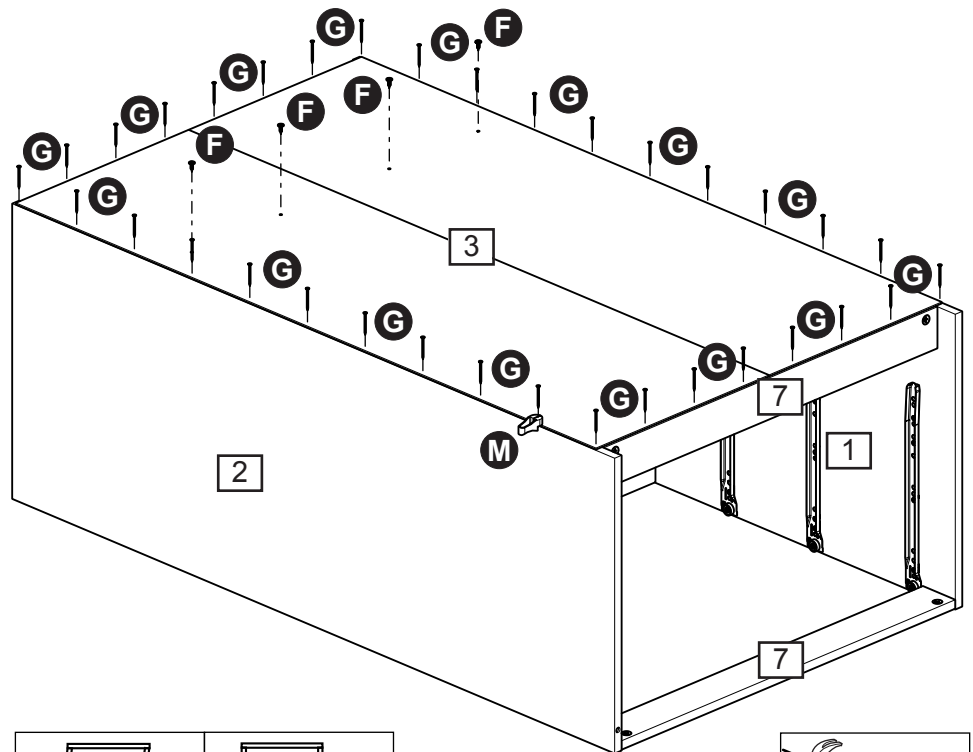

Assembly Instructions

Step - 7

Preparing drawer

Insert locking nuts **B** into left drawer side **9** and right drawer side **11**.

Make sure the 'arrow' on locking nuts **B** points towards the hole in the edge of **9** and **11**.

Put drop of glue **L** into the 3 holes of left drawer side **9** and right drawer side **11**.

Attach left drawer side **9** and right drawer side **11** onto drawer back **10**.

Insert drawer back **5**.

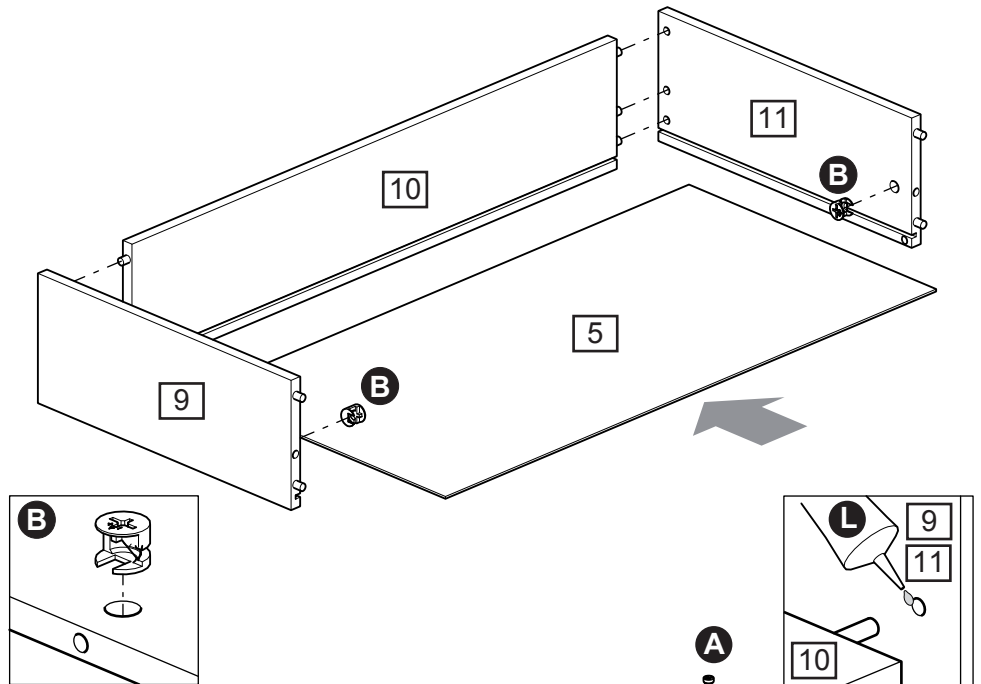

Step - 8

Screw 24mm locking screw **A** into drawer front **6**.

Note: Insert 24mm locking screw **A** as far as shown. **Do not over tighten.**

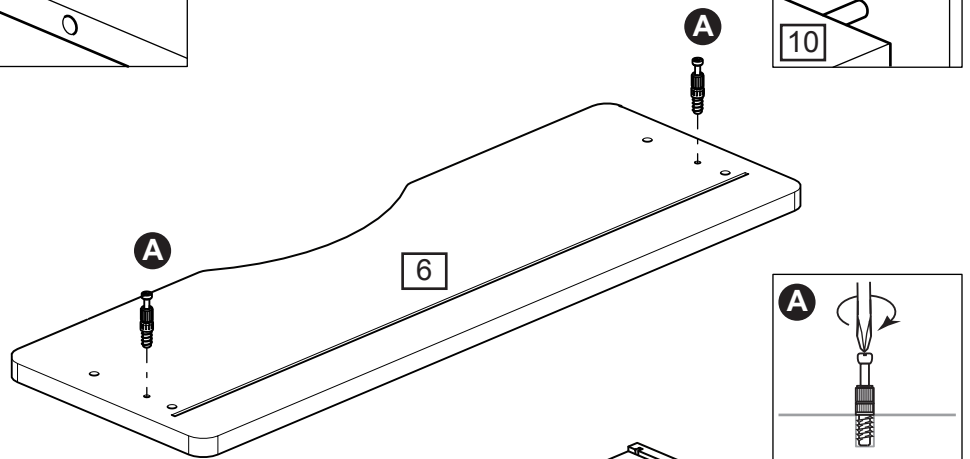

Step - 9

Position drawer onto drawer front **6**.

Use a screwdriver to turn locking nuts clockwise to lock

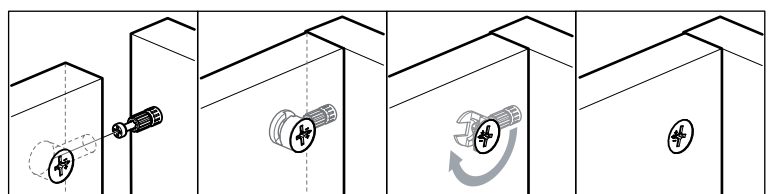
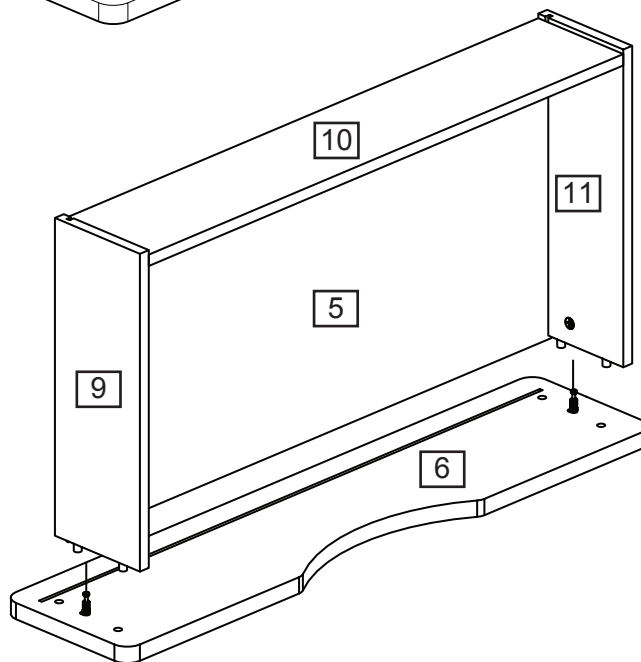

Assembly Instructions

Step - 10

a: Turn over drawer.
Fix runner left part B **Q**
on left drawer side **9** as
shown using 12,5mm pozi
screw **D**.
Fix runner right part B **Q**
on right drawer side **11** as
shown using 12,5mm pozi
screw **D**.

a:

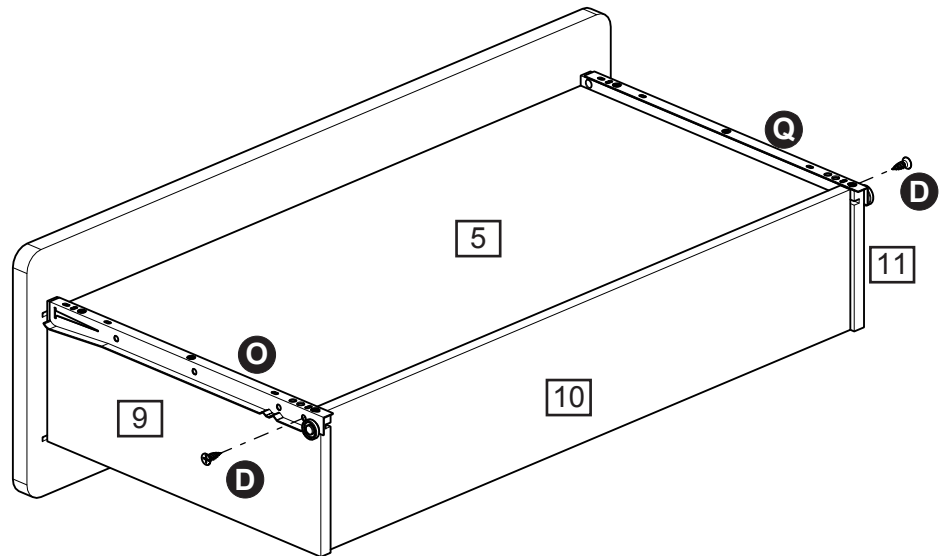

b: Fix runner left part B **Q**
and runner right part B **Q**
using 12,5mm pozi screw
D.
Slide drawer base support
I in corner as shown and fix
them, using the attached
screws .

b:

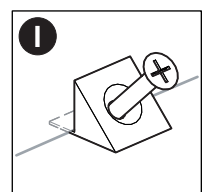
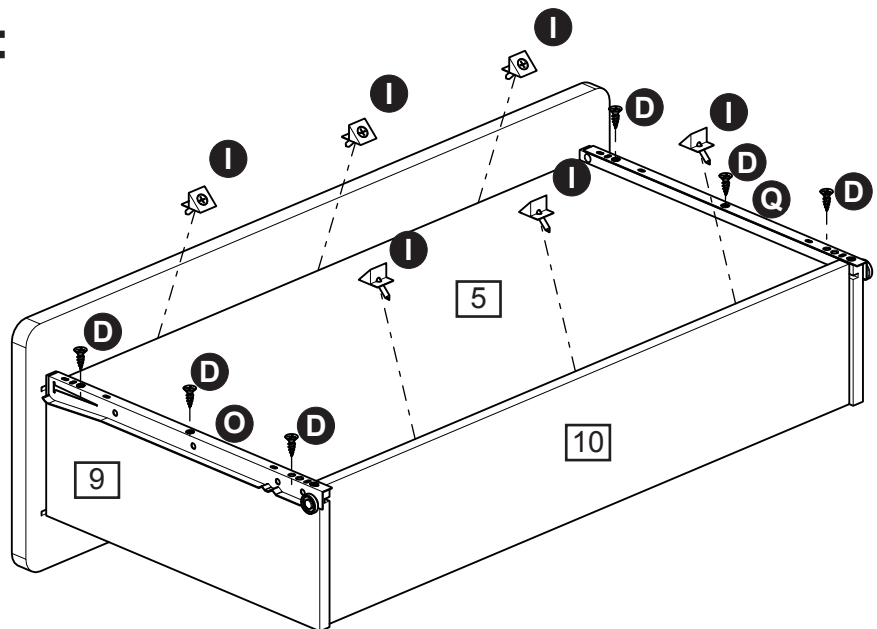

Assembly Instructions

Step - 11

Preparing drawer

Insert locking nuts **B** into left drawer side **12** and right drawer side **14**.

Make sure the 'arrow' on locking nuts **B** points towards the hole in the edge of **12** and **14**.

Put drop of glue **L** into the 3 holes of left drawer side **12** and right drawer side **14**.

Attach left drawer side **12** and right drawer side **14** onto drawer back **13**.

Insert drawer back **5**.

Do this step twice.

2x

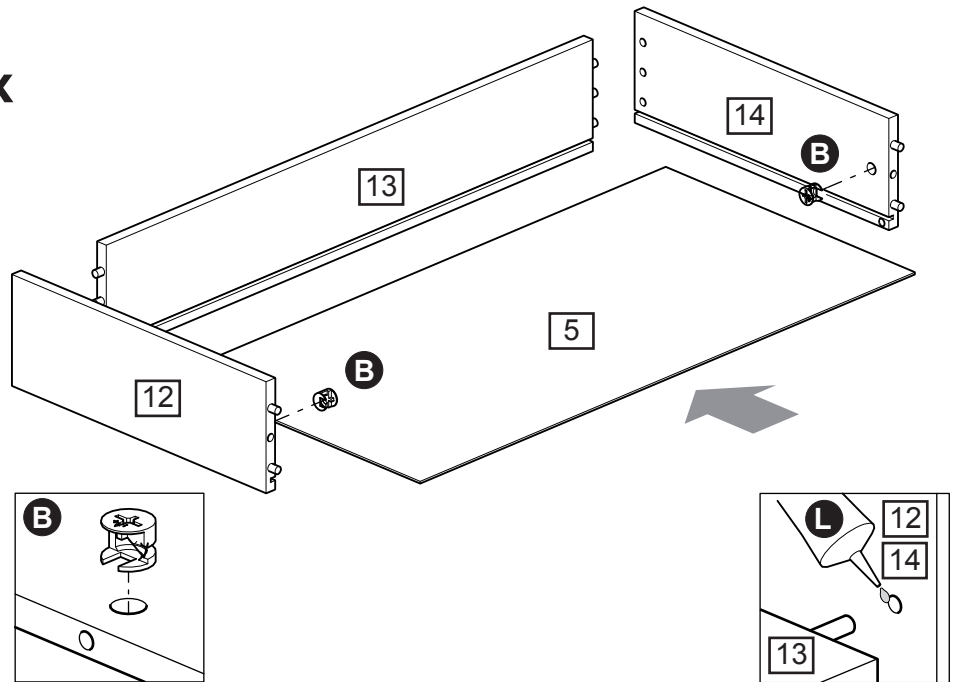

Step - 12

Screw 24mm locking screw **A** into drawer front **8**.

Note: Insert 24mm locking screw **A** as far as shown. **Do not over tighten.**

Do this step twice.

2x

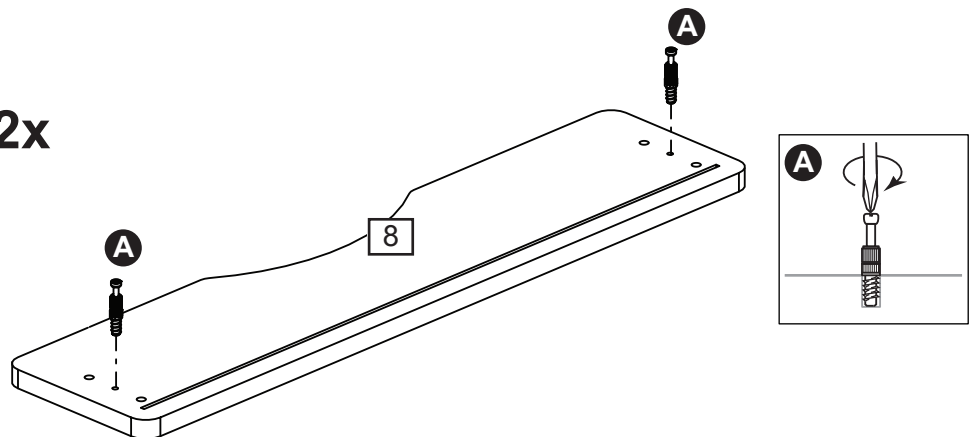

Step - 13

Position drawer onto drawer front **8**.

Use a screwdriver to turn locking nuts clockwise to lock.

Note: look carefully to the positions of drawer front **8**.

Do this step twice.

2x

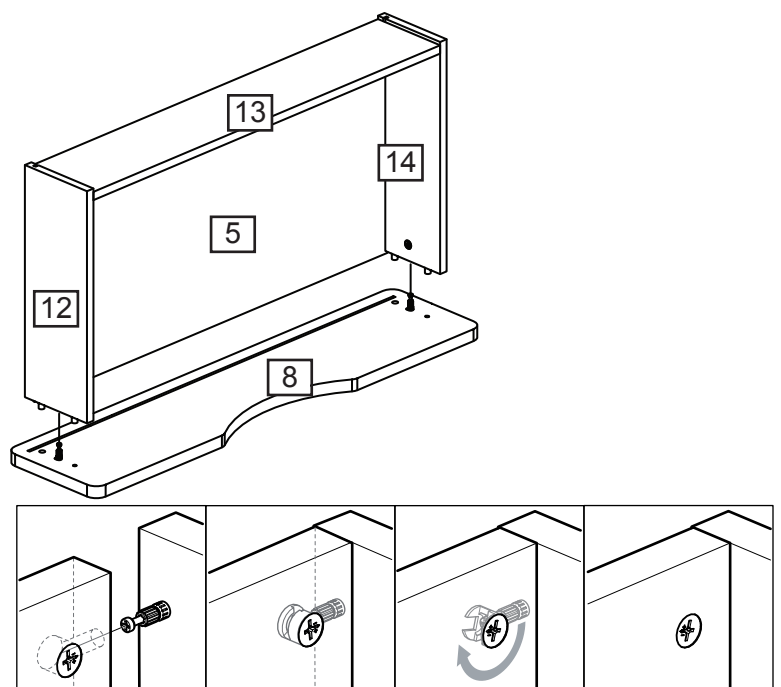

Assembly Instructions

Step - 14

a: Turn over drawer.
Fix runner left part B **O**
on left drawer side **12** as
shown using 12,5mm pozi
screw **D**.
Fix runner right part B **Q**
on right drawer side **14** as
shown using 12,5mm pozi
screw **D**.

a: 2x

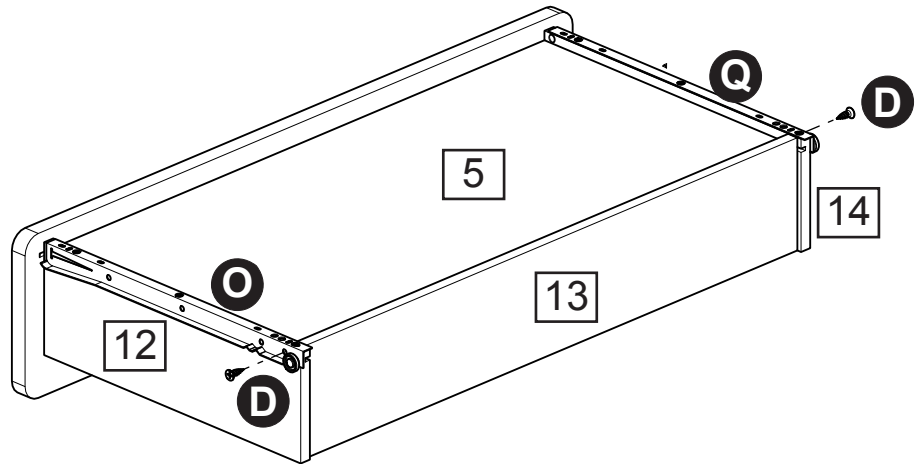

b: Fix runner left part B **O**
and runner right part B **Q**
using 12,5mm pozi screw
D. Slide drawer base
support **I** in corner as
shown and fix them, using
the attached nail.

b: 2x

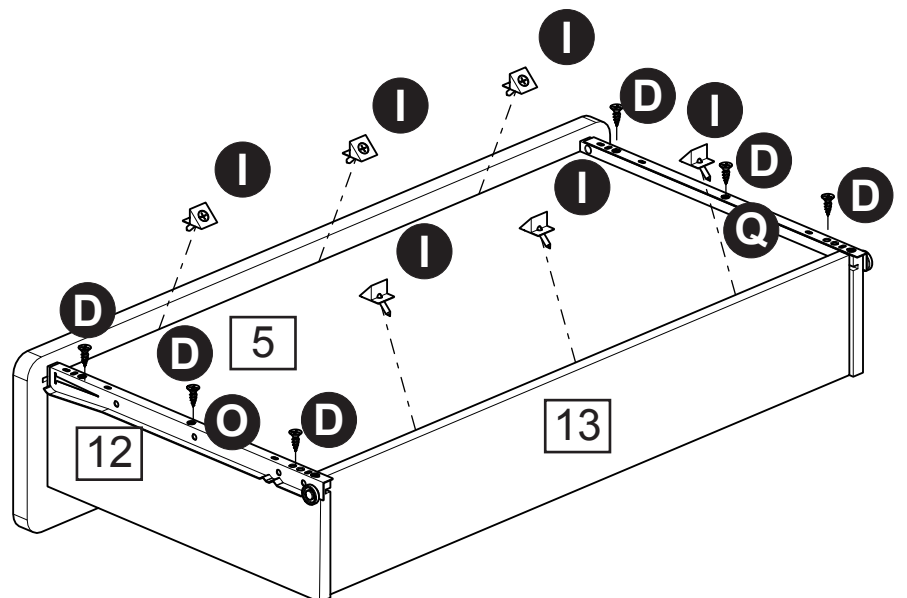

Do this step twice.

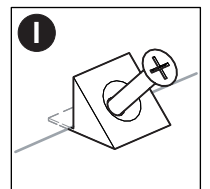

Assembly Instructions

Step - 15

Inserting drawers
as shown.

Position L-bracket **J** on top **4** as shown, fix using screw **F**.

Note: there is no pre-drilled hole for screw **F**.

Use **V** to fix on the wall, please see last page for more information.

Use peg **K** to square your furniture. Knock peg **K** in, as far as you require, under the end of the side of the furniture. Then snap off flush with the side.

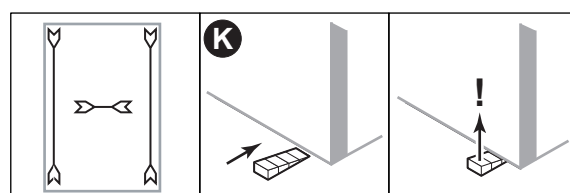
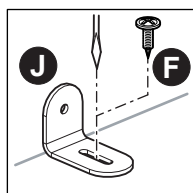
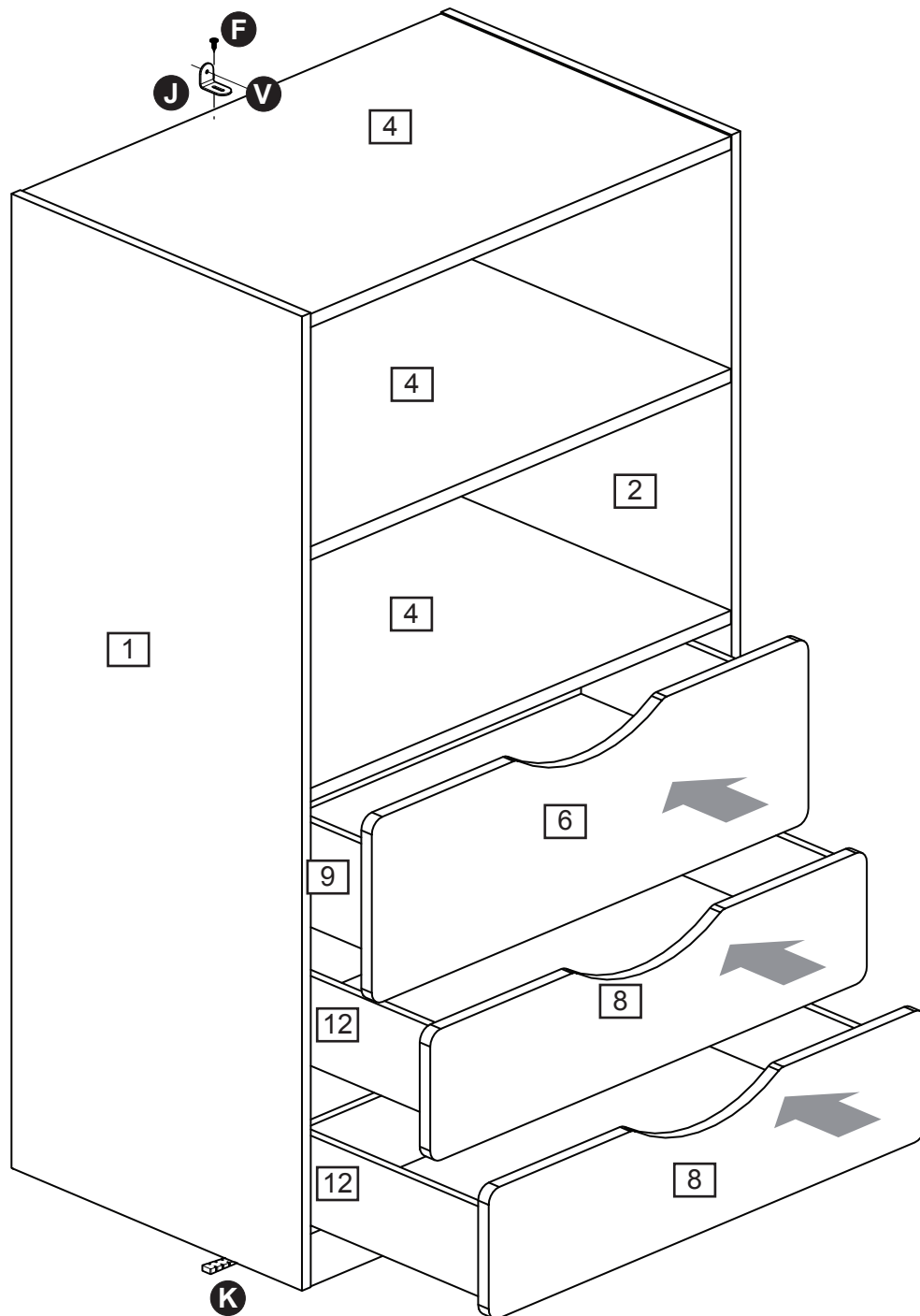

A Guide to - Wall Mounting & Fixings

Important note:

If plastic wall plugs are supplied with your product:



- these are only suitable for use in masonry walls.

If you are in any doubt about the correct wall plugs for your wall, seek professional advice.

Failure of the product due to using incorrect fixings is the responsibility of the installer.



Important: When drilling into walls always check that there are no hidden wires or pipes etc.

Make sure that the screws and wall plugs being used are suitable for supporting your unit. Consult a qualified tradesperson if you are unsure.

Hints:

- 1: **General rule:**  Always use a larger screw and wall plug if you are not sure.
- 2: Ensure you use the recommended drill bit to match the wall plug and hole size.
- 3: Ensure you drill the hole horizontally, do not force the drill or enlarge the hole.
- 4: Take extra care when drilling high walls, ceilings and ceramic tiles. Ensure wall plugs are inserted beyond the thickness of the ceramic tiles to avoid the tiles splitting or cracking.
- 5: Ensure wall plugs are well fitted and are a tight fit in the drilled hole.

Types of walls

You can use one of the following types of wall plug if your walls are made of brick, breeze block, concrete, stone or wood.

No.1 "General Purpose" wall plug

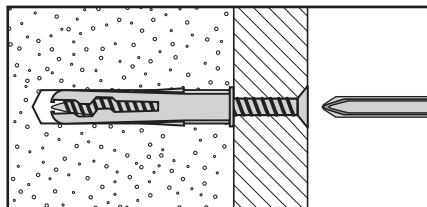

Generally aerated blocks should not be used to support heavy loads, use a specialist fitting in this case. For light loads, general purpose wall plugs can be used.

No.2 "Plasterboard" wall plug

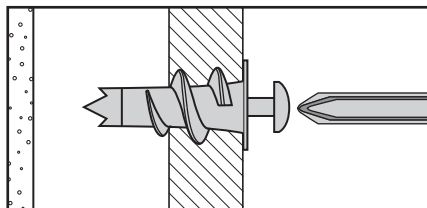

For use when attaching light loads on to plasterboard partitions.

No.3 "Cavity Fixing" wall plug

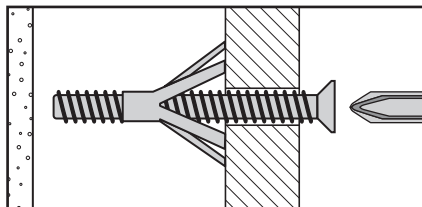

For use with plasterboard partitions or hollow wooden doors.

No.4 "Cavity Fixing-Heavy Duty" wall plug

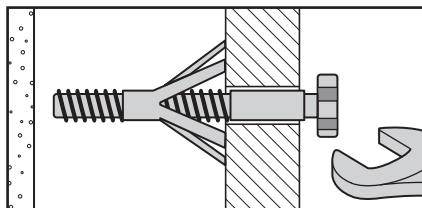

For use when fitting or supporting heavy loads such as shelving, wall cabinets and coat racks.

No.5 "Hammer Fixing" wall plug

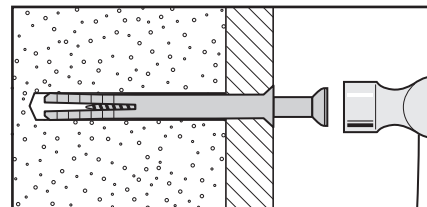

For use with walls stuck with plasterboard. The hammer fixing allows it to be fixed to the wall rather than the plasterboard. Always check the fixing is secure to the retaining wall.

No.6 "Shield Anchor" wall plug Heavy loads

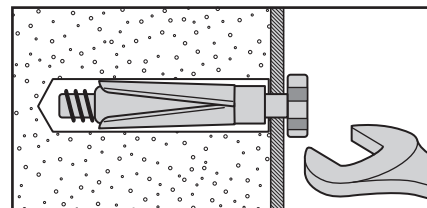

For use with heavier loads such as TV & HiFi speakers and satellite dishes etc.



Care & Maintenance

Safety: Always check the fitting and location to ensure your safety in and around the home.

Fitting: From time to time check the fitting to ensure the wall plugs or screws do not become loose.