

# amberley spindle chair

Assembly Instructions - Please keep for future reference

457/3760

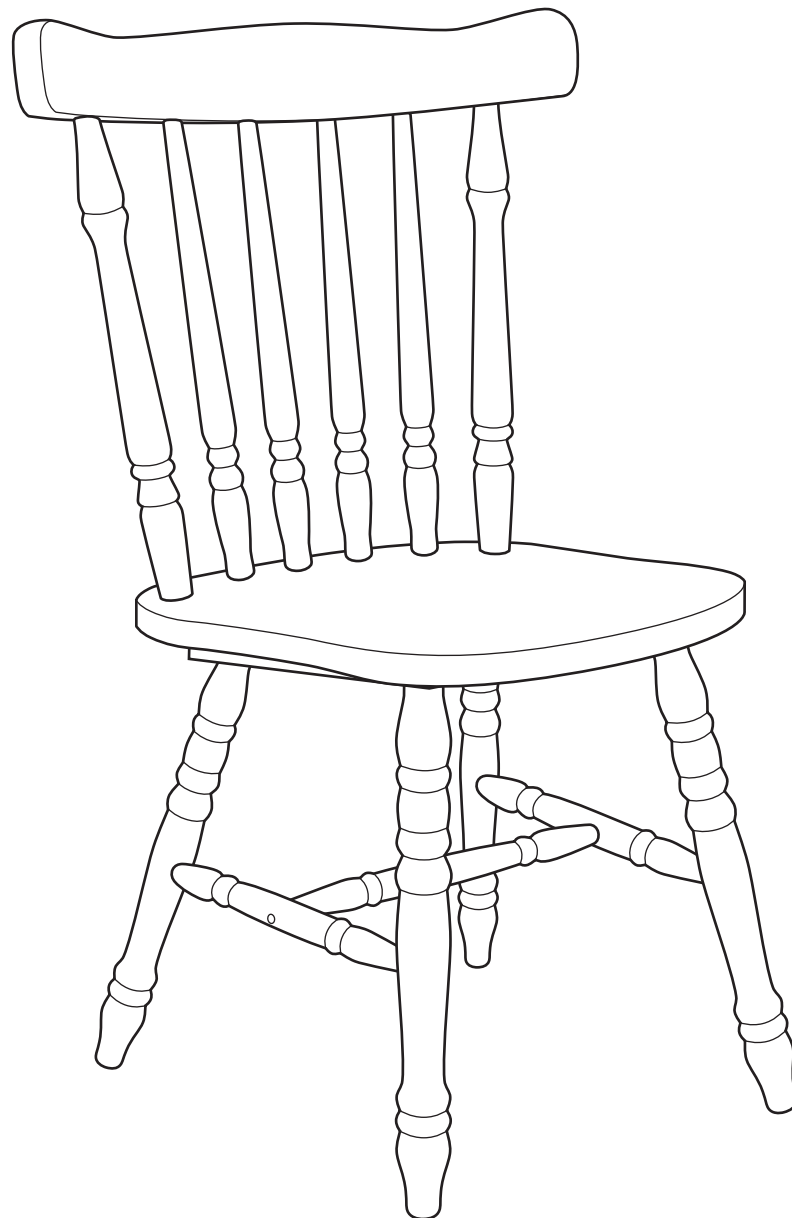

## Dimensions

Width - 53.5cm  
Depth - 51cm  
Height - 86.5cm

**Important** - Please read these instructions fully before starting assembly

If you need help or have damaged or missing parts, call the **Customer Helpline:**  
**Argos = 0345 640 0800**



# Safety and Care Advice

**Important** - Please read these instructions fully before starting assembly

- Check you have all the components and tools listed on the following pages.
- Remove all fittings from the plastic bags and separate them into their groups.
- Keep children and animals away from the work area, small parts could choke if swallowed.
- Make sure you have enough space to layout the parts before starting.

- During assembly do not stand or put weight on the product, this could cause damage.
- Assemble the item as close to its final position (in the same room) as possible.
- Assemble on a soft level surface to avoid damaging the unit or your floor.
- Parts of the assembly will be easier with 2 people.



• We do not recommend the use of power drill/drivers **for inserting screws**, as this could damage the unit. Only use hand screwdrivers.

- Unit weight: 6 kgs.
- Maximum safe weight of user: 110kgs.

## Care and maintenance

- Only clean using a damp cloth and mild detergent, do not use bleach or abrasive cleaners.
- From time to time check that there are no loose screws on this unit.

- Do not stand on the chair.
- Do not use this chair as step ladder.
- This product should not be discarded with household

waste. Take to your local authority waste disposal centre.

## Handy Hints

- Assemble all parts and bolts loosely during assembly, only once the product is complete should you fully tighten the bolts.
- Regularly check and ensure that all bolts and fittings are tightend properly.

# Components - Parts

If you have damaged or missing components, call the Customer Helpline: Argos = 0345 640 0800

Please check you have all the parts listed below

**Note:** The quantities below are the correct amount to complete the assembly of 1 chair.

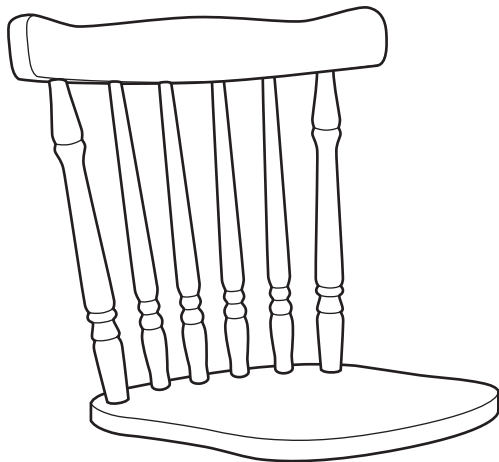

**1** Seat Frame  
(53.5 x 45 x 46.5cm)

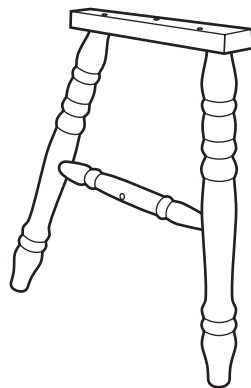

**2** Left Leg Frame (FL)  
(4 x 44.5 x 43.5cm)

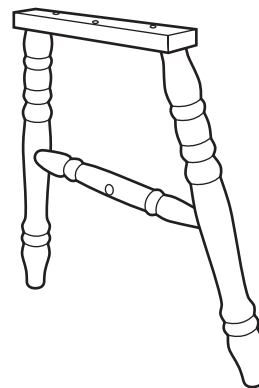

**3** Right Leg Frame (FR)  
(4 x 44.5 x 43.5cm)







**4** Stretcher  
(Ø2.8 x 33.8cm)

# Components - Fittings

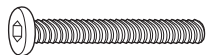
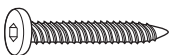
Please check you have all the fittings listed below

**Note:** The quantities below are the correct amount to complete the assembly of 1 chair. In some cases more fittings may be supplied than are required.

<p><b>A</b> </p> <p>M6 x 50mm Bolt x 2</p>	<p><b>B</b> </p> <p>M7 x 35mm Screw x 6</p>	<p><b>C</b> </p> <p>Barrel Nut x 2</p>
<p><b>D</b> </p> <p>Wood Cap x 2</p>	<p><b>E</b> </p> <p>Allen Key x 1</p>	<p><b>F</b> </p> <p>Foot Pads x 4</p>

## Tools required



Crosshead screwdriver

**Ruler** - Use this ruler to help correctly identify the screws

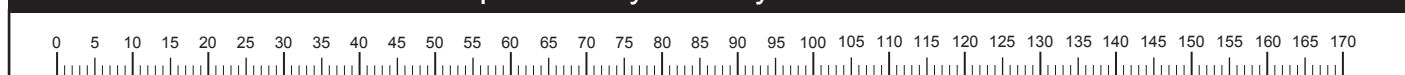

# Assembly Instructions

## Step 1

### Attaching stretcher

Attach the stretcher **4** into the holes on left leg frame **2** and right leg frame **3** as shown. Place the barrel nuts **C** into the holes on the stretcher. Then align the holes on the barrel nut by turning it using a crosshead screwdriver to be able to fix the bolts **A** through holes on the legs. Tighten the bolts using the allen key **E**.



**Important note:**

Ensure to correctly position the leg frame marked with "FL" (front left) and "FR" (front right).



**Important note:**

Do not fully tighten bolts at this stage

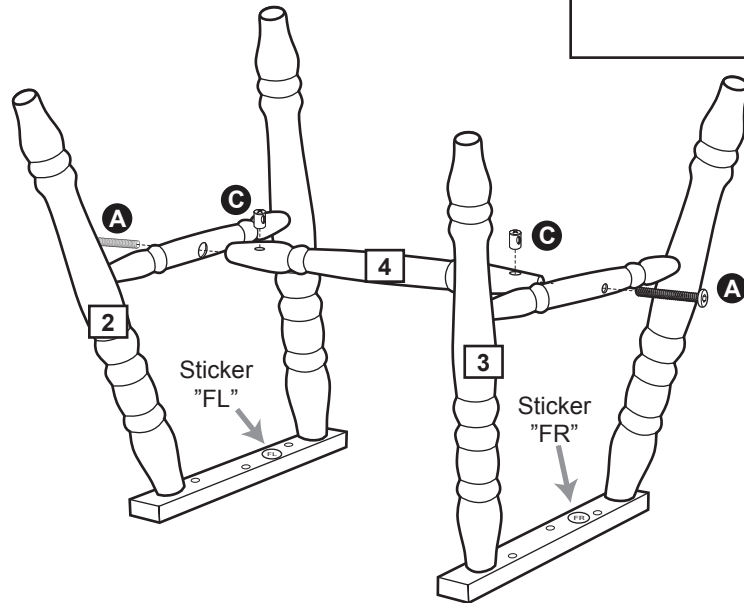
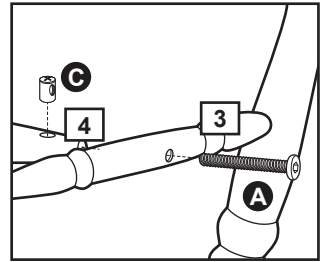

## Step 2

### Attaching leg frames

Place the seat frame **1** upside down on a raised protected surface. Position the assembled legs making sure part of the legs with labels "FL" and "FR" are on the front of seat frame as shown. Then fix through the holes using the screw **B**.



**Important note:**

Before fully tightening the screw **B**, fully tighten the bolts **A** assembled in step 1 first.

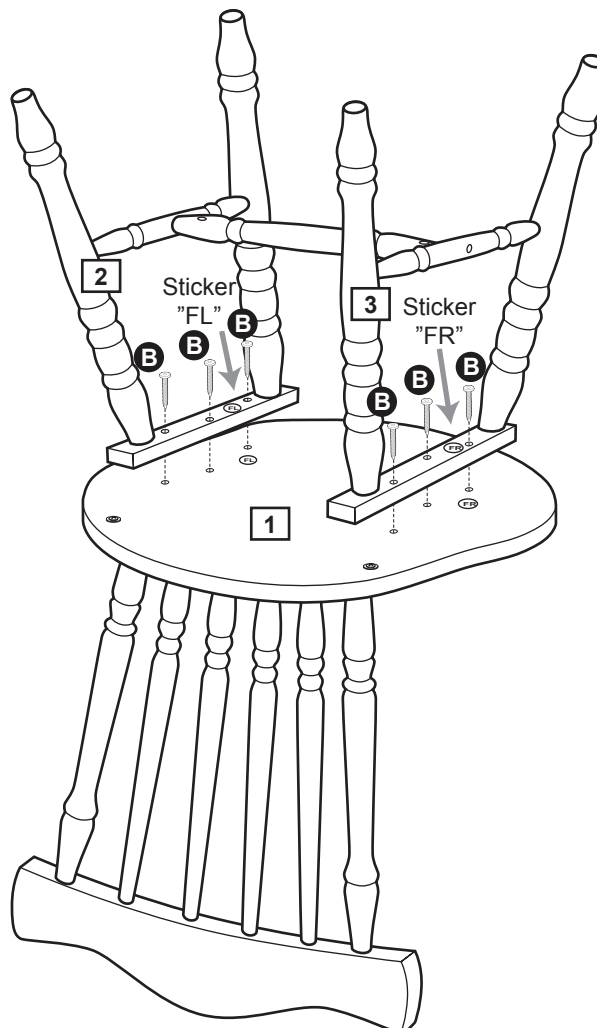
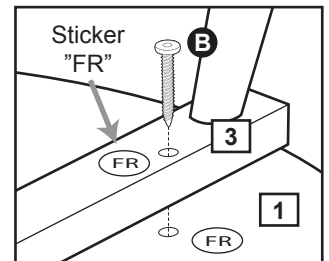

# Assembly Instructions

## Step 3

### Attaching foot pads

Remove backing from foot pads **F** and carefully position on the bottom of the leg frames **2** and **3** as shown.

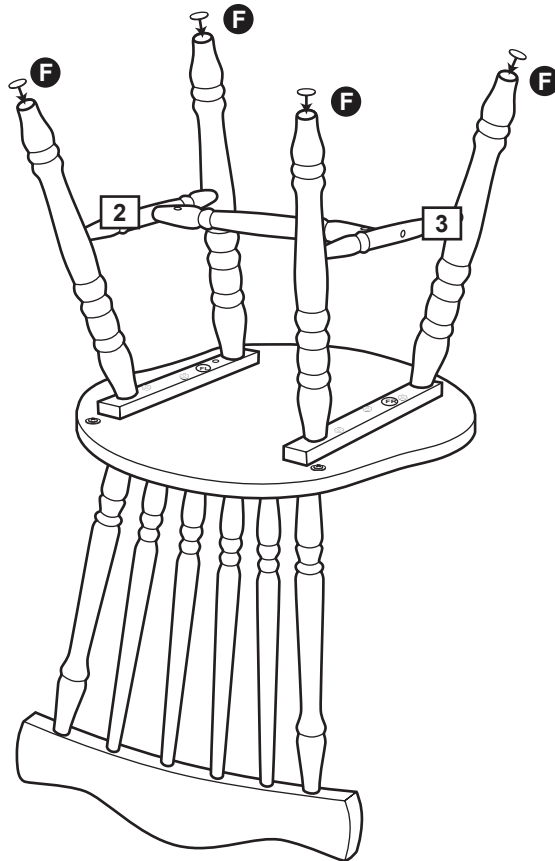

## Step 4

### Attaching wood caps

Carefully turn the chair upright and place the wood caps **D** into the holes on the leg frames **2** and **3** as shown.

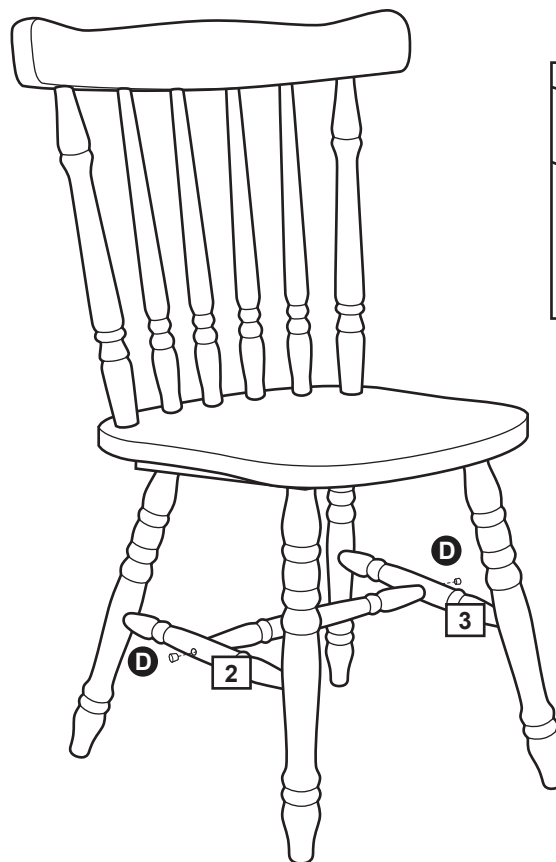

Assembly is complete.

If you need help or have damaged or missing parts, call the **Customer Helpline:**  
**Argos = 0345 640 0800**