

INSTRUCTIONS FOR USE

TUMBLE DRYERS

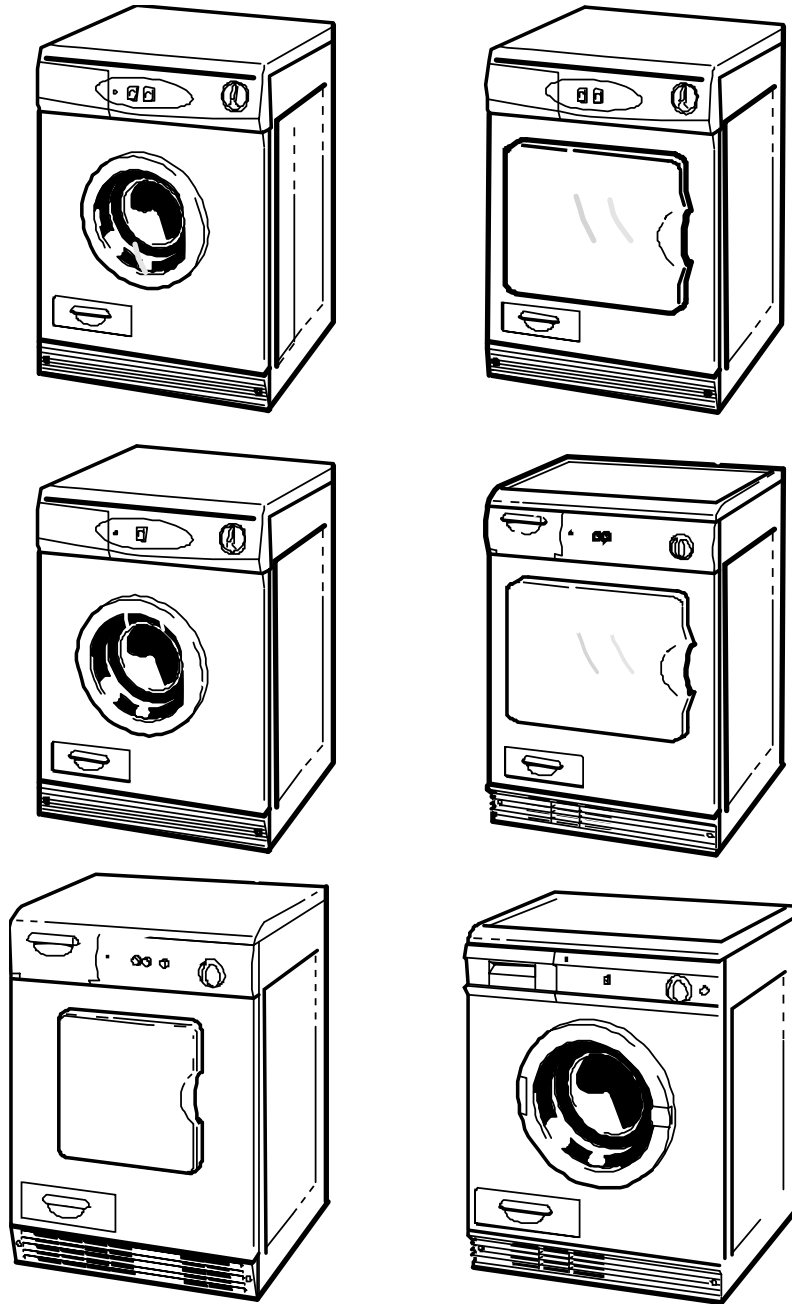

GB

IMPORTANT

PLEASE READ THESE INSTRUCTIONS THOROUGHLY BEFORE USING THIS APPLIANCE.
KEEP THEM IN A SAFE PLACE FOR FUTURE REFERENCE.

INSTALLATION

Position the tumble dryer so that the plug remains accessible after installation. Do not block the vent at the front or base of the dryer, as this will impair the working of the machine. This appliance must not be installed behind a lockable door, a sliding door or a door with hinges on the opposite side to that of the tumble dryer.

DRAINAGE OPTIONS

Your new tumble dryer is fitted with an internal drain pump, which gives you the option of being able to drain condensed water to its water bottle, or to your household waste pipe. Connecting your dryer to a household waste pipe will mean you will not need to periodically empty the water bottle. As supplied, the drier will drain the water to its bottle. If you wish to convert the dryer so that its water is diverted to a household waste pipe, follow the simple instructions below:-

1/ Pull the drain hose from the valve at the top of the unit.

2/ Fit the drain hose into your household waste pipe, ensuring a gap between the end of the hose and any water in the waste pipe.

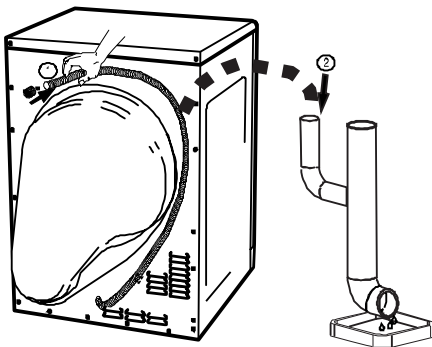

To return your drier back to taking the condensed water to the water bottle, simply fit the drain hose back to the valve at the top of your drier.

If the drain hose is not long enough to reach your waste pipe, a drain extension kit can be obtained from your retailer (part number 4213 089 8778).

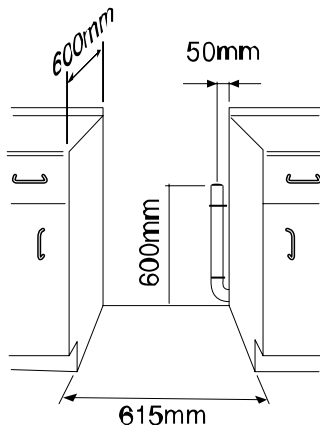

The illustration shows the minimum space required by the dryer and the position of the waste-pipe within this space and behind the dryer. If a trap is fitted it must not obstruct the air inlet at the back of the dryer. The waste pipe can be positioned on either side of the dryer.

If the waste pipe is used by the dryer and a washing machine then its diameter must be large enough to contain both hoses - 1.5" bore (38mm) minimum.

FINAL INSTALLATION

Push the filter into its operating position as shown in the diagram. If you wish to change the side on which your door opens, see the instructions on the back page. Remove any dust by wiping the drum and door with a damp cloth. Any initial smell of burning will be caused by dust on the heater and will quickly disappear.

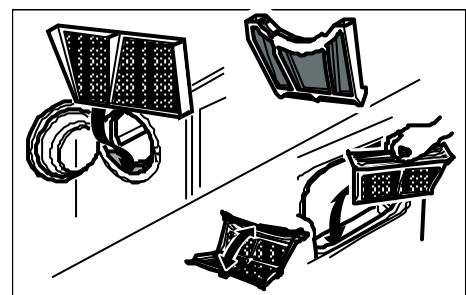

THE CONTROLS

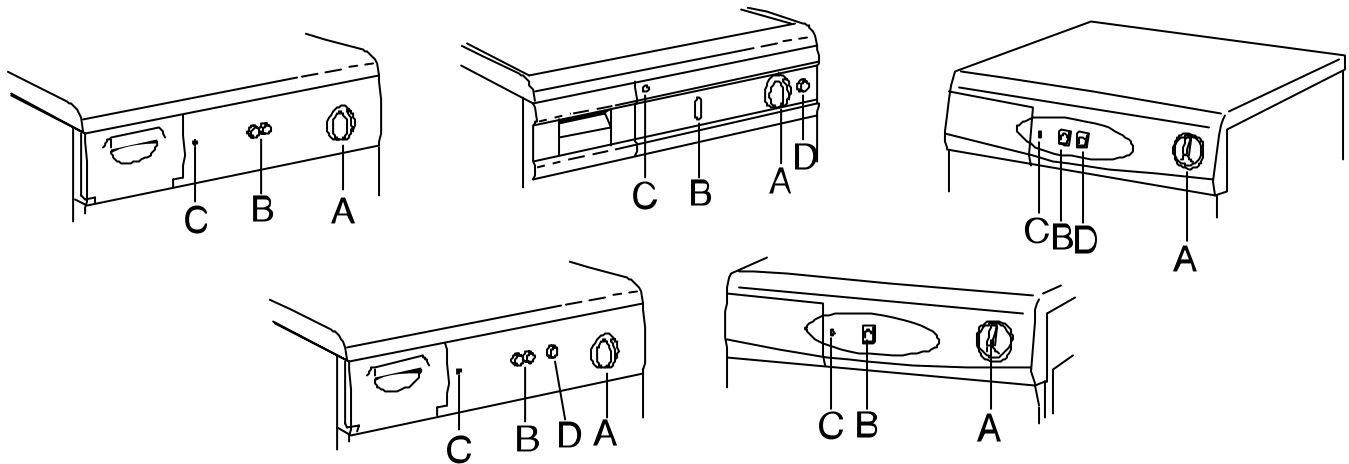





- A. THE TIMER** Select the required drying time based on the recommendations on the control panel.
- B. HEAT SWITCH(ES)** Select the required heat setting based on the recommendations on the control panel.
- C. BOTTLE FULL NEON** This will light when the bottle needs emptying or when it is incorrectly inserted.
- D. START BUTTON (IF FITTED)** Press Start button after closing the door and selecting the required drying time.

PREPARATION

Check care labels inside the garments.

CARE LABELS YOU MAY FIND ON YOUR FABRICS

| | |
|---|----------------------------|
|  | Suitable for tumble drying |
|  | Tumble dry using full heat |
|  | Tumble dry using half heat |
|  | Do not tumble dry |

Do not tumble dry woollen or wool mixture articles unless the article is labelled as being suitable. This should avoid shrinkage.

Place delicate articles e.g. tights, scarves, inside a pillowcase.

To avoid the need to iron easycare polyester/cotton items it is better to only dry small loads (i.e. half fill drum) It is better to dry small and large articles together.

Fabric softeners, or similar products, should be used as specified by the Fabric Softener instructions. Do not overload the dryer or dry large bulky items such as duvets or sleeping bags as it is important that the airflow through the dryer is not obstructed.

Items that have been soiled with substances such as cooking oil, acetone, alcohol, petrol, kerosene, spot removers, turpentine, waxes and wax removers should be washed in hot water with an extra amount of detergent before being dried in the tumble dryer.

Items such as foam rubber (latex foam), shower caps, waterproof textiles, rubber backed articles and clothes or pillows fitted with foam rubber pads should not be dried in the tumble dryer.

OPERATION

Open the door.

Load clothes loosely into the drum.

Load sheets first, starting with one corner.

Close the door.

Dry your hands.

Check that the timer is in the '0' position.

Plug in the machine.

Select correct heat position, (see programme chart on control panel for recommendations).

Set the timer to the required time setting (see programme chart on control panel for recommendations).

Press the start button if fitted.

The drum will begin rotating. Reversing drum models will stop periodically to rotate in the reverse direction for a short time.

Should the clothes become dry before the cycle has finished, or if an excessive programme time has been selected, the drum will continue to rotate while the thermostat will automatically regulate the heater to reduce the risk of over drying.

If the door is opened during a cycle the dryer will stop. To restart, close the door and press the start button (if fitted). When drying large items such as sheets, we suggest you periodically stop the dryer to redistribute the load.

There is an automatic 12 minute cool down period at the end of every cycle, during which the heater is switched off. This helps to minimize creasing, and must always be used fully to avoid the risk of fire.

NEVER SWITCH THE DRYER OFF AND LEAVE A HOT LOAD IN THE DRUM. RISK OF FIRE.

ALWAYS CLEAN THE FILTER AFTER EACH USE. Failure to do so could cause the safety cut-out to operate.

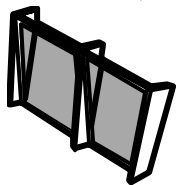

- Pull the filter upwards and away from the appliance.
- Remove any threads or fluff by hand or with a soft brush.
- Slide the filter back.
- Wash the filter occasionally in detergent solution using a soft brush to remove small particles.
- If your filter becomes damaged, replace it to ensure no damage is caused to the dryer.

ALWAYS EMPTY THE WATER BOTTLE

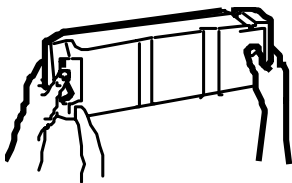

- Open the door, pull out and empty the bottle.
- Replace the bottle ensuring that it is pushed all the way in - if it is not, the dryer will not operate.
- If the dryer is connected to a drain there is no need to empty the bottle but it must be correctly fitted to the machine.

THE CONDENSER

The condenser and ducting should be cleaned monthly or more frequently if the dryer is in constant use. See “**CLEANING THE CONDENSER**” below.

NOTE: The condenser will discolour through use.

REMOVING THE CONDENSER

–Firmly pull the condenser out.

RE-INSTALLING THE CONDENSER

–Carefully push the condenser back into the machine, until it is pushed fully home and a “click” is heard.

IMPORTANT:

- Ensure all lint and fluff is removed from around the grille seal before closing or water may leak.
- The dryer may leak if the condenser is not correctly re-installed.

CLEANING THE CONDENSER

CAUTION: For maximum efficiency, the plates are made from very thin aluminum and are easily damaged. Do not try to poke anything between the plates or use a hard object or tool for cleaning. At all times, handle the condenser carefully and avoid crushing the plates.

- Remove the condenser (see above).
- Flush the fluff from between the plates under running water and carefully shake off excess water.

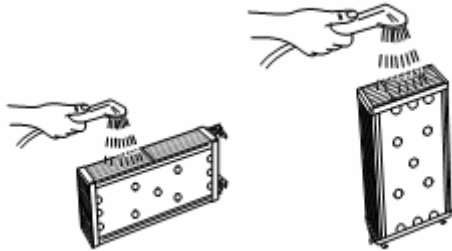

Whilst the condenser is removed, clean as much fluff as possible from inside the ducting by reaching a hand into the machine. In particular, keep the passage from the fan clear (on the right hand side of the condenser duct). After cleaning, re-install the condenser (see above).

ANY PROBLEMS

If the clothes are not dry after normal drying time:

- Check that you used the correct heat setting.
- Check that you have not set the timer within a cool down period.
- Check that the lint filter has been cleaned. A blocked filter will restrict the airflow.
- Check that the condenser unit and associated duct work are clean. If blocked, these will restrict the airflow.
- Check that your dryer is heating - below the door to the left side, should feel warm to the touch after the first 10-15 minutes of its programme.

Failure to heat may indicate the safety cut-out has operated. To reset, simply press the red button at the rear of the machine. If it has operated then a sharp “click” will be heard.

This cut-out only operates if the airflow is severely restricted so make sure the filter is clean and that all other restrictions are removed before re-starting.

If the cut-out continues to operate after checking the above points, you should contact your service agent. Check that the machine has the correct weight load in the drum before stating the appliance.

If your machine does not work check the following before calling a service engineer:-

- Check that there is a supply of electricity.
- Check that the door has been properly closed and the machine is switched on (start button pressed, if fitted).
- Check that the water bottle has been withdrawn from, and–replaced into the machine. The bottle full warning light should be off.
- Check the fuse in the moulded plug.

OPTIONAL EXTRAS

Stacking Kit.

This enables the dryer to be stacked on top of another similar flat topped appliance. Only stack kit 0312-004-01000 should be used. Any other stack kit may affect performance.

The above item can be purchased as an accessory for your tumble dryer from your supplier.

TECHNICAL DATA

OVERALL DIMENSIONS:

Height:85 cm

Width:59.5 cm

Depth:58 cm

MAXIMUM DRY WEIGHT LOADS:

Cotton 7kg

(For minimum creasing 2kg)

Delicates 2kg

For electrical ratings see plate on back of dryer.

For Model No. see serial plate inside door (needed when requesting service).

Room temperature range 5°C to 30°C. (Drying performance decreases as room temperature falls).

Your washing machine should have a spin speed of not less than 1000rpm for maximum efficiency.

IMPORTANT USER INFORMATION

–This tumble dryer is intended for **NORMAL DOMESTIC USE ONLY**.

–Please note it is not recommended that the dryer is placed directly next to ovens or cookers as the performance of the dryer may be affected.

–A carpet must not obstruct the ventilation openings in the base of the dryer.

–Do not stack the tumble dryer on top of other appliances without the correct stacking kit.

–Any electrical work required to install the appliance should be carried out by a qualified person.

–It is important to clean the lint filter after each drying cycle and the condenser every month or the restrictions to airflow will extend drying times and could cause the safety cut-out to trip.

–Under no circumstances should anything other than the recommended articles be placed in the tumble dryer.

–The tumble dryer should be serviced by an appointed service organisation and only genuine parts used.

–It is dangerous to alter or modify the product in any way other than fitting authorized accessories.

–We recommend that the appliance is unplugged each time after use. It should always be disconnected from the electricity supply or long periods (i.e. weekends, if it is to be left unattended for holidays etc.)

–The rear of the dryer gets quite hot during use. Position the dryer so that the back is not accessible while in operation, but ensure that the sides have a space available to allow airflow.

–The special mains cable and plug assembly must only be replaced with a genuine part from the manufacturer or our appointed service agent.

It is important to clean fluff from the window of the dryer and around the door seal after each drying cycle. Failure to do so could result in water leaking.

This appliance is not intended for use by persons (including children) with reduced physical, sensory or mental capabilities, or lack of experience and knowledge, unless they have been given supervision or instruction concerning use of the appliance by a person responsible for their safety.

Children should be supervised to ensure they do not play with the appliance.

Fabric softeners, or similar products, should be used as specified by the fabric softener instructions.

WARNING: Never stop a tumble dryer before the end of a drying cycle unless all items are quickly removed and spread out so that heat is dissipated.

Remove all objects from pockets such as lighters and matches.

DO NOT use a two-way adaptor, or extension lead. The dryer must be connected to its own socket.

DO NOT block the air inlets at the front, base, rear and side of your dryer.

DO NOT allow fluff to accumulate around the tumble dryer. Risk of fire

DO NOT exceed the recommended maximum load.

DO NOT dry unwashed items in the tumble dryer

DO NOT place articles in the dryer if anything other than a water solution has been used in the cleaning process.

DO NOT attempt to dry dripping wet articles.

DO NOT use the tumble dryer if you suspect that it is damaged in any way. Under no circumstances should you attempt to repair the appliance yourself. Repairs carried out by inexperienced persons may cause serious injury. Consult your local appointed service engineer and insist on genuine spare parts.

THIS APPLIANCE MUST BE EARTHED

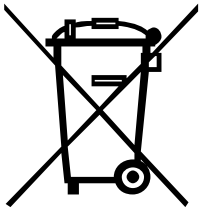

This appliance is marked according to the European Directive 2002/96/EC on Waste Electrical and Electronic Equipment (WEEE).

This guideline is the frame of a European wide validity of return and Recycling on Waste Electrical and Electronic Equipment.



This label, positioned on the rear of your dryer, indicates the surface is hot when in operation - avoid touching.



**CAUTION
HOT SURFACE**

REVERSING THE DOOR OPENING

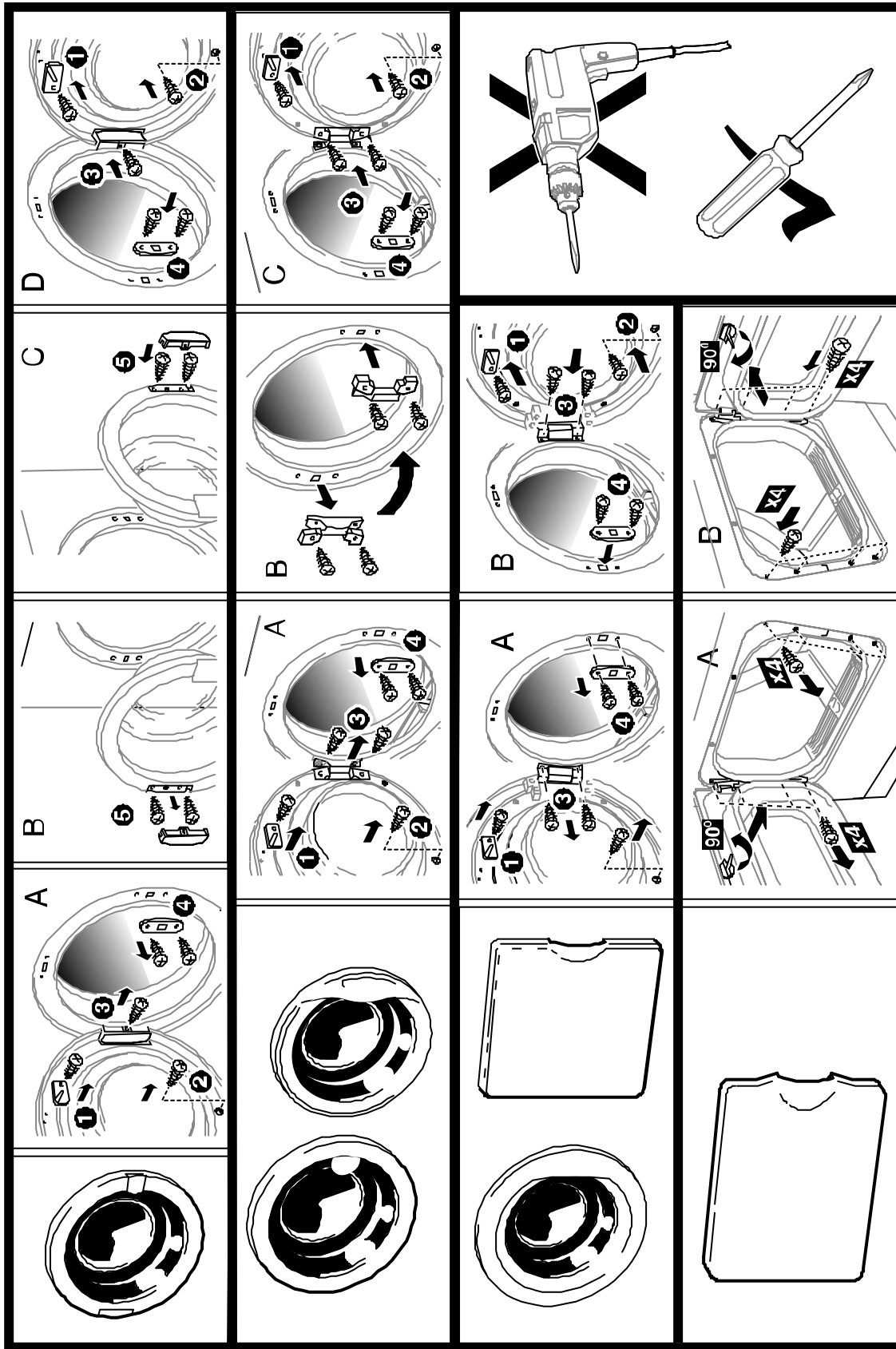

SELECT DOOR TYPE