

# HYGENA PAIR OF RETRO CHAIRS

Assembly Instructions - Please keep for future reference

462/5670

**hygena**

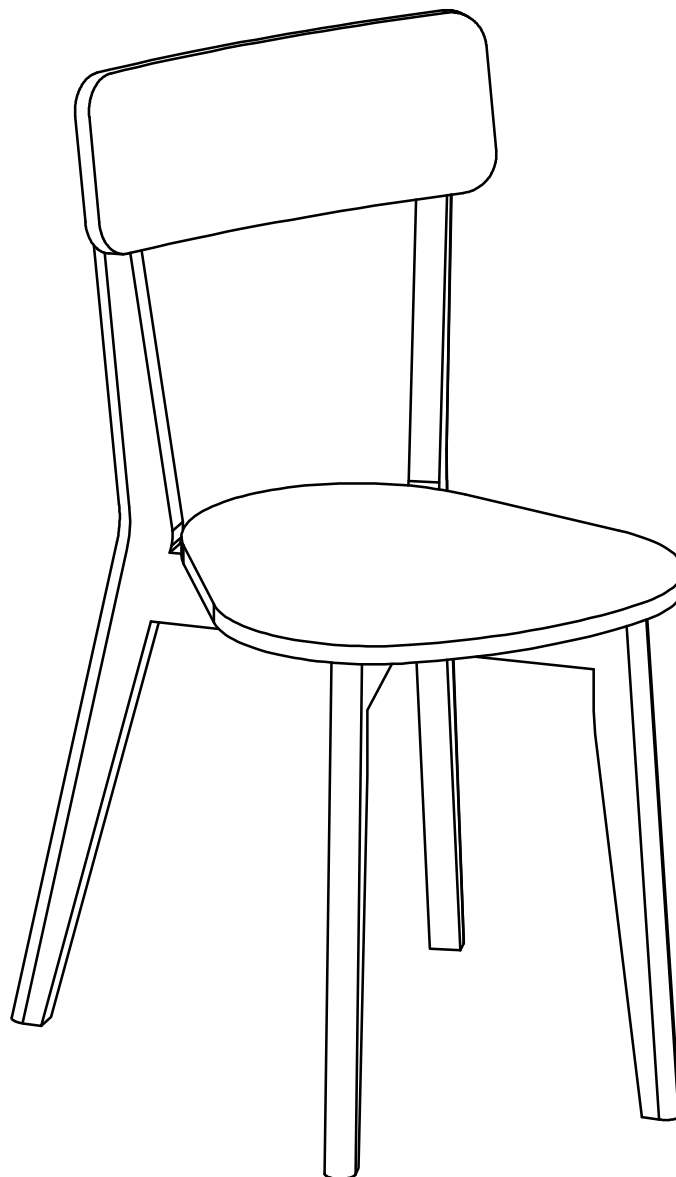

## Dimensions

Width - 43.3cm

Depth - 47.5cm

Height - 79.8cm

**Important – Please read these instructions fully before starting assembly**

need help or have damaged or missing parts, call the **Customer Helpline:0345 6400800**



# Safety and Care Advice

## Important – Please read these instructions fully before starting assembly

- Check you have all the components and tools listed on the following pages.
- Remove all fittings from the plastic bags and separate them into their groups.
- Keep children and animals away from the work area, small parts could choke if swallowed.
- Make sure you have enough space to layout the parts before starting.
- Parts of the assembly will be easier with 2 people.
- During assembly do not stand or put weight on the product, this could cause damage.
- Assemble the item as close to its final position (in the same room) as possible.
- Assemble on a soft level surface to avoid damaging the unit or your floor.
- Do not stand on the chair.
- Do not use this chair as step ladder.



- To reduce the likelihood of damaging your product please **ensure that your** power drill is set on a low torque setting.
- Maximum safe weight of user: 110kgs.

## Care and maintenance

- Only clean using a damp cloth and mild detergent, do not use bleach or abrasive cleaners.
- From time to time check that there are no loose screws on this unit.
- This product should not be discarded with household waste. Take to your local authority waste disposal centre.

## Handy Hints

- Assemble all parts and bolts loosely during assembly, only once the product is complete should you fully tighten the bolts.
- Regularly check and ensure that all bolts and fittings are tightend properly.

# Components - Panels

If you have damaged or missing components, call the **Customer Helpline: 0345 6400800**

Please check you have all the panels listed below

The quantities below are for 2 chairs

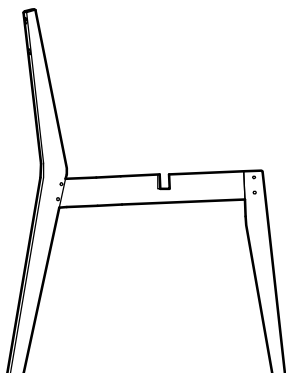

**1** Chair frame x 2  
(75.6 x 57.5cm)

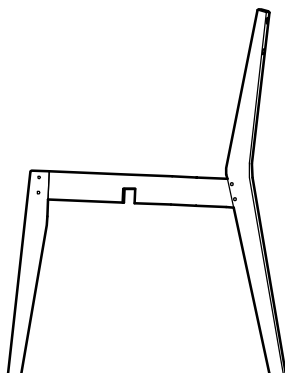

**2** Chair frame x 2  
(75.6 x 57.5cm)

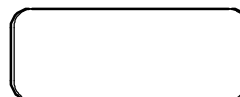

**3** Backrest x 2  
(39.6 x 14.5cm)

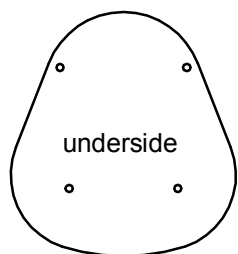





**4** Seat pad x 2 (42.2x39.8cm)

# Components - Fittings

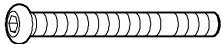
Please check you have all the fittings listed below

**Note:** The quantities below are the correct amount to complete the assembly of 2 chairs. In some cases more fittings may be supplied than are required.

<p><b>A</b> </p> <p>68mm Bolt x 8</p>	<p><b>B</b> </p> <p>50mm Screw x 2</p>	<p><b>C</b> </p> <p>26mm Bolt x 8</p>
<p><b>D</b> </p> <p>Plain washer x 8</p>	<p><b>E</b> </p> <p>Hex key x 1</p>	

**Ruler** - Use this ruler to help correctly identify the screws

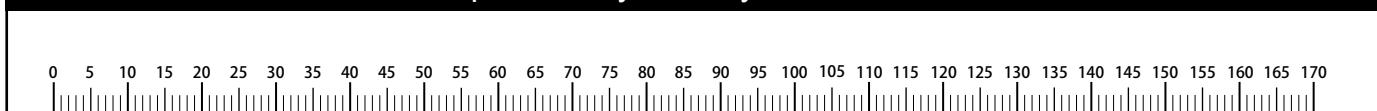

# Assembly Instructions

## Step 1

### Attaching chair frame

Attach chair frame **2** to chair frame **1** as shown in the figure.

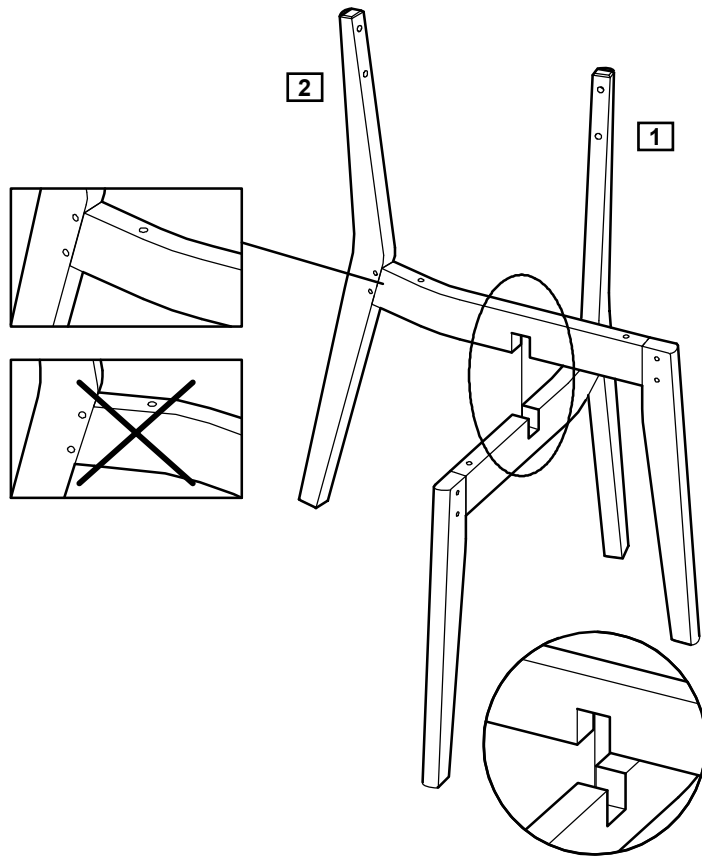

## Step 2

### Assemble seat pad

Place seat pad **4** upside down on a clean, flat surface.

Carefully position the chair frame on the seat pad and secure using bolts **A** and plain washers **D**.

**Note:** Do not fully tighten bolts.

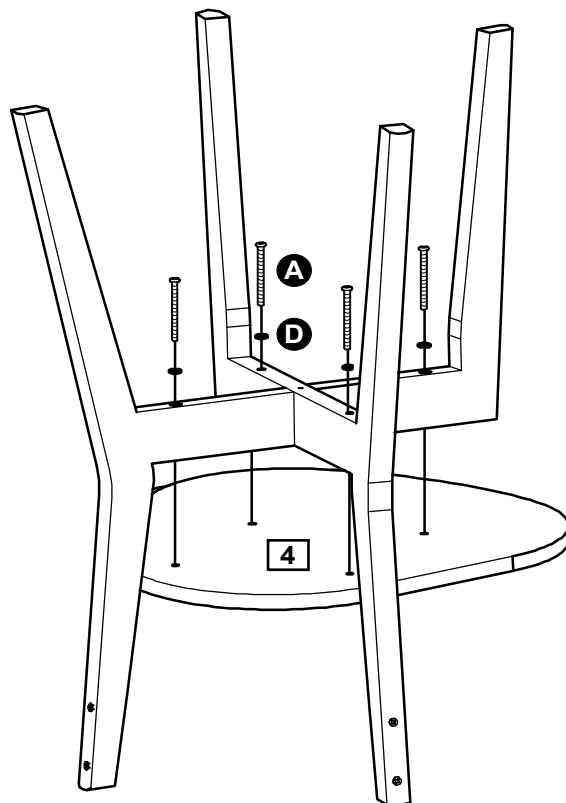

# Assembly Instructions

## Step 3

### Assemble backrest

Parts of the assembly will be easier with 2 people.

Assemble backrest **3** to the chair frame using screw **C**

**Note: tighten the screws.**

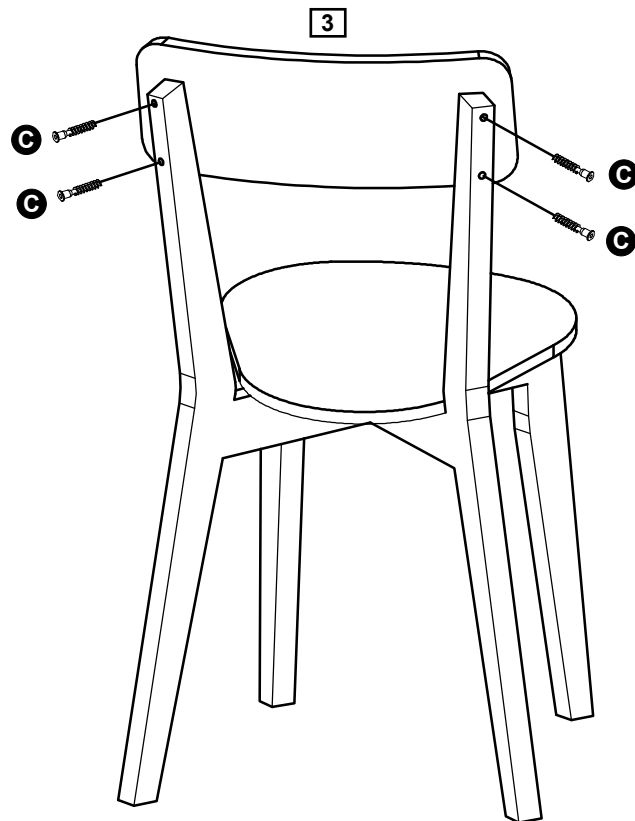

## Step 4

### Fixing chair frames

upside down chair on a clean surface, secure chair frame **1** and **2** using screw **B**

**Re-tighten all the bolts.**

**Turn the chair upright.  
Assembly is complete.**

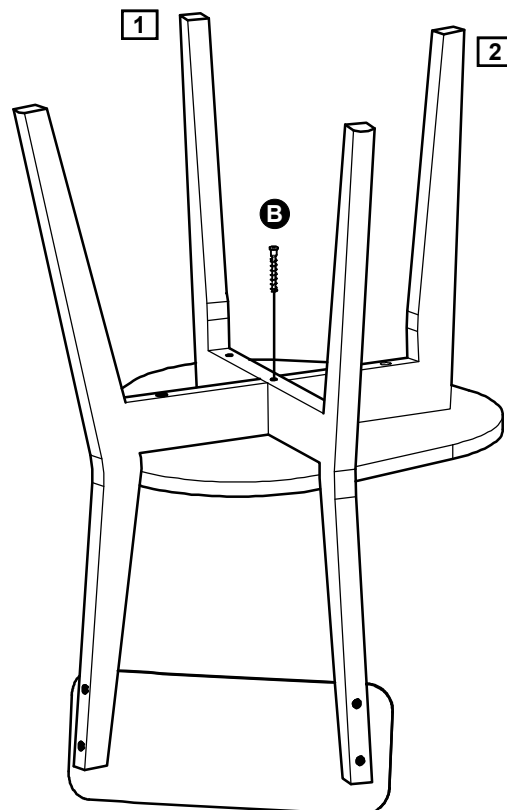

If you need help or have damaged or missing parts, call the **Customer Helpline: 0345 6400800**