

# Assembly Instructions

## Step 1

Place table top upside down being careful not to scratch the table top (lift the product within its cardboard packaging will assist you being able to do this)

**a:** Attach the legs **2** (x4) to each of the corners, by first step insert spring washers **B** and washers **C** into all the bolts **A**. Then screw the bolts **A** through the corner blocks and into the holes in the legs **2**. Tighten bolts by using the allen key **D**.

**Fully tighten all bolts.**

**b:** 2 people are required for this next stage.

Turn the table upright and place on desired location.

**Assembly is complete.**

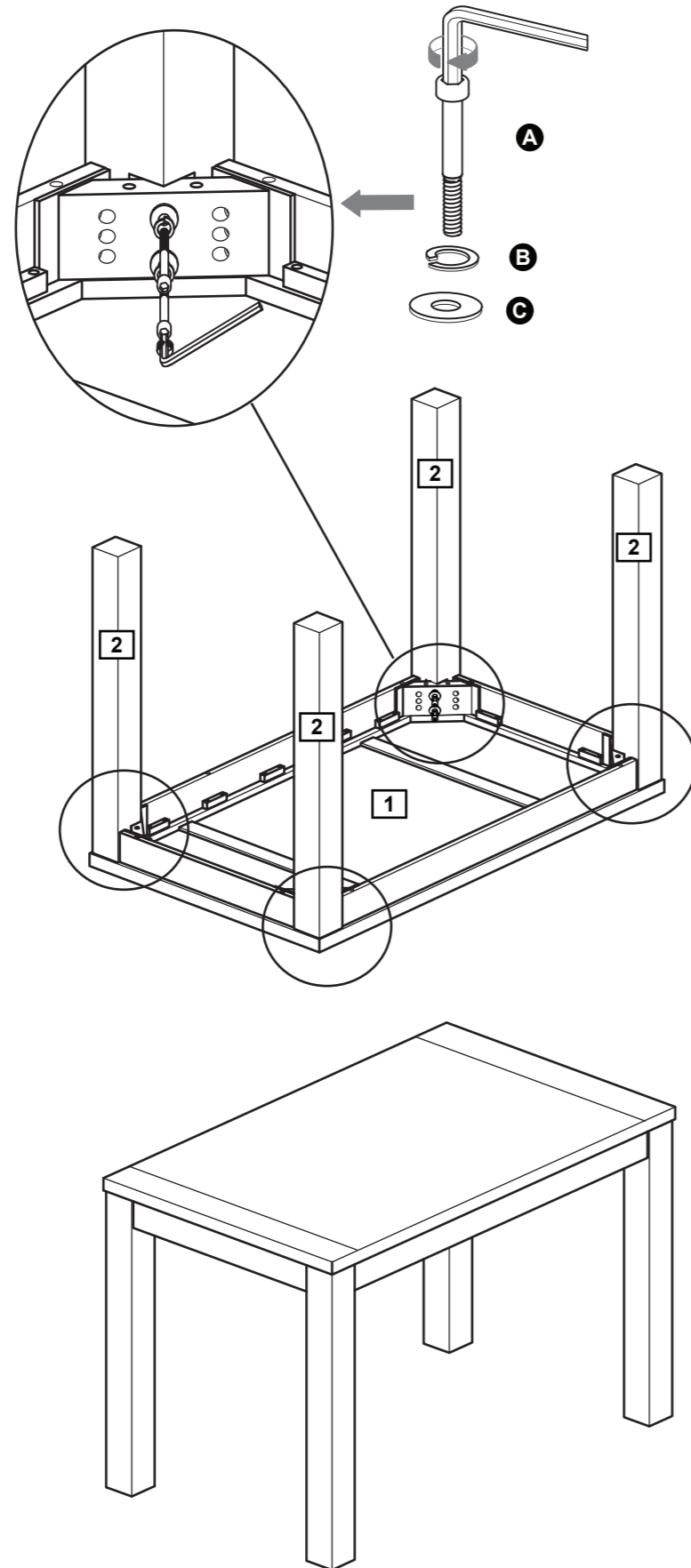

# Pemberton Table 150CM

Assembly Instructions - Please keep for future reference

459/0860

450/7107

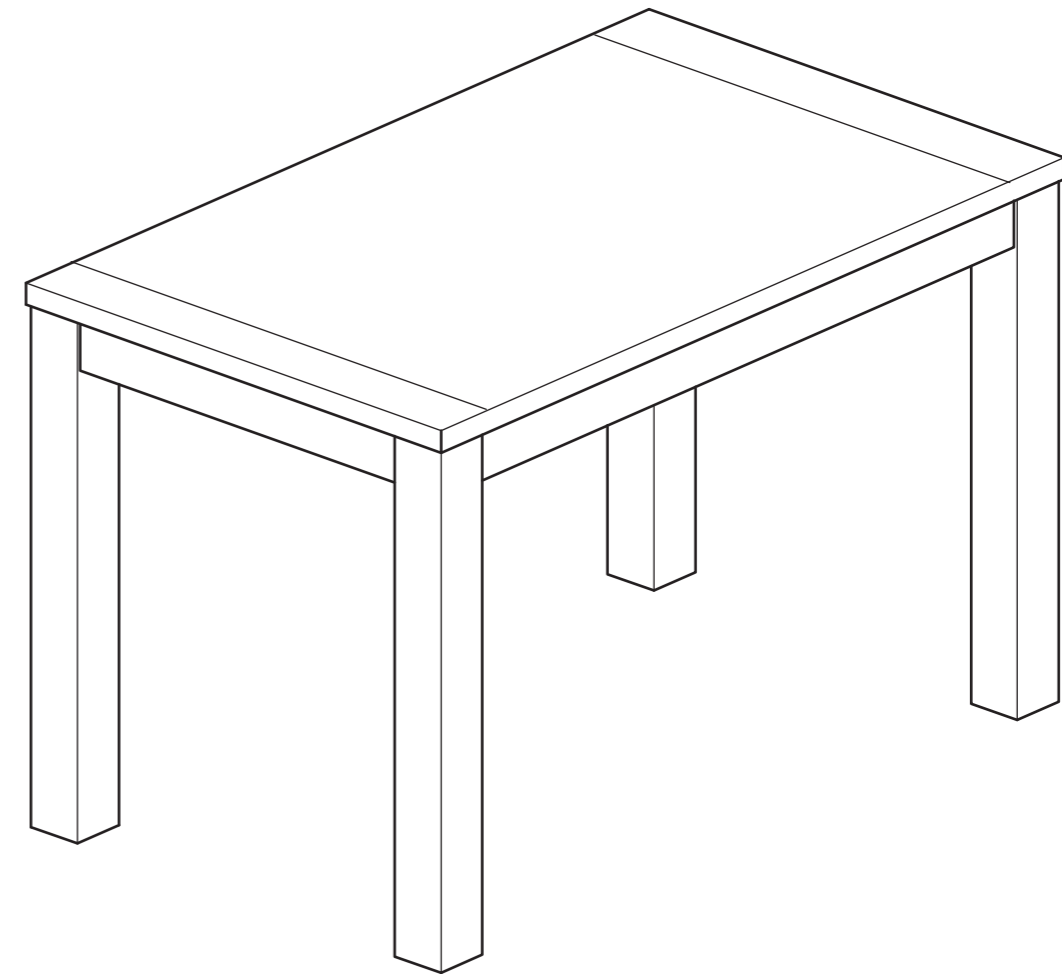

## Dimensions

Width - 150cm  
Depth - 90cm  
Height - 75cm

**Important – Please read these instructions fully before starting assembly**

If you need help or have damaged or missing parts, call the **Customer Helpline: 0345 640 0800**

# ! Safety and Care Advice

## Important – Please read these instructions fully before starting assembly

- Check you have all the components and tools listed on the following pages.
- Remove all fittings from the plastic bags and separate them into their groups.
- Keep children and animals away from the work area, small parts could choke if swallowed.
- Make sure you have enough space to layout the parts before starting.
- During assembly do not stand or put weight on the product, this could cause damage.
- Assemble the item as close to its final position (in the same room) as possible.
- Assemble on a soft level surface to avoid damaging the unit or your floor.
- Parts of the assembly will be easier with 2 people.



- To reduce the likelihood of damaging your product please ensure that your power drill is set on a low torque setting.
- Dispose of all packaging carefully and responsibly.

## Care and maintenance

- Only clean using a damp cloth and mild detergent, do not use bleach or abrasive cleaners.
- From time to time check that there are no loose screws on this unit.
- This product should not be discarded with household waste. Take to your local authority waste disposal centre.

## Handy Hints

- Assemble all parts and bolts loosely during assembly, only once the product is complete should you fully tighten the bolts.
- Regularly check and ensure that all bolts and fittings are tightened properly.

# Components - Parts

If you have damaged or missing components, call the **Customer Helpline: 0345 640 0800**

## Please check you have all the parts listed below

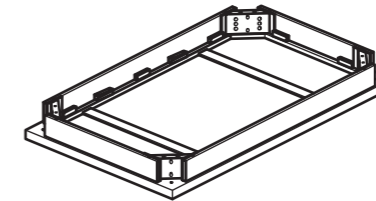

**1** Table top x 1

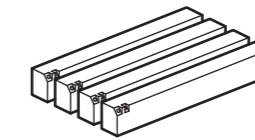





**2** Leg x 4

# Components - Fittings

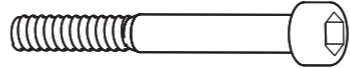
## Please check you have all the fittings listed below

**Note:** The quantities below are the correct amount to complete the assembly. In some cases more fittings may be supplied than are required.

<p><b>A</b> </p> <p>Bolt x 8</p>	<p><b>B</b> </p> <p>Spring washer x 8</p>	<p><b>C</b> </p> <p>Washer x 8</p>
<p><b>D</b> </p> <p>Allen key x 1</p>		