



**INSTRUCTIONS MANUAL**

**REFRIGERATOR**

**CCBF5182WWK**

**CCBF5182AWK**

**CCBF5182BWK**

# CONTENTS

■ Safety Information	
■ Safety Instructions	
Meaning of safety warning symbols .....	4
Electricity related warnings .....	5
Related warnings for use .....	5
Warnings related to placing items .....	6
■ Introduction	
Names of components .....	7
Thermostat .....	8
Illuminating lamp and replacement .....	8
Placement .....	8
Start .....	8
Cleaning .....	9
Stop using .....	9
■ Trouble Shooting	
The following simple issues can be handled by the user. Please call the after-sale service department if the issues are not settled .....	10
■ Door Reversibility	
Door install guidelines about swapping left&right .....	11-13
■ Scrapping Old Appliances	
■ Instructions for the water dispenser	
■ Tips for energy saving	

Thank you for purchasing this product.

Before using your refrigerator, please carefully read this instruction manual in order to maximize its performance. Store all documentation for subsequent use or for other owners. This product is intended solely for household use or similar applications such as:

- the kitchen area for personnel in shops, offices and other working environments
- on farms, by clientele of hotels, motels and other environments of a residential type
- at bed and breakfasts (B & B)
- for catering services and similar applications not for retail sale.

This appliance must be used only for purposes of storage of food, any other use is considered dangerous and the manufacturer will not be responsible for any omissions. Also, it is recommended that you take note of the warranty conditions.

## SAFETY INFORMATION

The refrigerator contains a refrigerant gas (R600a: isobutane) and insulating gas (cyclopentane), with high compatibility with the environment, that are, however, inflammable.

We recommend that you follow the following regulations so as to avoid situations dangerous to you:

- Before performing any operation, unplug the power cord from the power socket.
- The refrigeration system positioned behind and inside the refrigerator contains refrigerant. Therefore, avoid damaging the tubes.
- If in the refrigeration system a leak is noted, do not touch the wall outlet and do not use open flames. Open the window and let air into the room. Then call a service centre to ask for repair.
- Do not scrape with a knife or sharp object to remove frost or ice that occurs. With these, the refrigerant circuit can be damaged, the spill from which can cause a fire or damage your eyes.
- Do not install the appliance in humid, oily or dusty places, nor expose it to direct sunlight and to water.
- Do not install the appliance near heaters or inflammable materials.
- Do not use extension cords or adapters.
- Do not excessively pull or fold the power cord or touch the plug with wet hands.
- Do not damage the plug and/or the power cord; this could cause electrical shocks or fires.
- It is recommended to keep the plug clean, any excessive dust residues on the plug can be the cause fire.
- Do not use mechanical devices or other equipment to hasten the defrosting process.
- Absolutely avoid the use of open flame or electrical equipment, such as heaters, steam cleaners, candles, oil lamps and the like in order to speed up the defrosting phase.
- Do not use or store inflammable sprays, such as spray paint, near the refrigerator. It could cause an explosion or fire.
- Do not use electrical appliances inside the food storage compartments, unless they are of the type recommended by the manufacturer.
- Do not place or store inflammable and highly volatile materials such as ether, petrol, LPG, propane gas, aerosol spray cans, adhesives, pure alcohol, etc. These materials may cause an explosion.
- Do not store medicine or research materials in the refrigerator. When the material that requires a strict control of storage temperatures is to be stored, it is possible that it will deteriorate or an uncontrolled reaction may occur that can cause risks.
- Maintain the ventilation openings in the appliance enclosure or in the built-in structure, free of obstruction.
- Do not place objects and/or containers filled with water on the top of the appliance.
- Do not perform repairs on this refrigerator. All interventions must be performed solely by qualified personnel.
- This appliance can be used by children aged from 8 years and above and by persons with reduced physical, sensory or mental capabilities or with a lack of experience and knowledge; provided that they have been given adequate supervision or instruction concerning how to use the appliance in a safe way and understand the hazards involved.

Children should not play with the appliance. Cleaning and user maintenance should not be made by children without supervision.

Turning the knob fully counterclockwise, you will hear a click which corresponds to the switch-off of the product.



When the appliance is installed, the electrical cord and the current socket must be easily reached.

The socket is compatible with the plug of the appliance. If not, request replacement of the plug by an authorized technician; do not use extension cords and/or multiple connectors.

Do not touch the internal parts or frozen food with moist or wet hands as it can cause burns.

# SAFETY INSTRUCTIONS

## ► Meaning of safety warning symbols

	The symbols indicate prohibited matters, and those behaviors are forbidden. Non-compliance with the instructions may result in product damages or endanger the personal safety of users.
Prohibition symbols	
	The symbols indicate matters that must be followed, and those behaviors must be strictly executed in line with the operation requirements. Non-compliance with the instructions may result in product damages or endanger the personal safety of users.
Warning symbols	
	The symbols indicate matters to pay attention to, and these behaviors shall be specially noted. Due precautions are needed or minor or moderate injuries or damages of the product will be caused.
Note symbols	

This manual contains lots of important safety information which shall be observed by the users.

# SAFETY INSTRUCTIONS

## ► Electricity related warnings

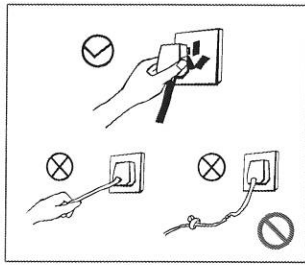

- Do not pull the power cord when pulling the power plug of the refrigerator. Please firmly grasp the plug and pull out it from the socket directly.
- Do not damage the power cord under any condition so as to ensure safety use, do not use when the power cord is damaged or the plug is worn.
- Worn or damaged power cord shall be replaced in manufacture-authorized maintenance stations.

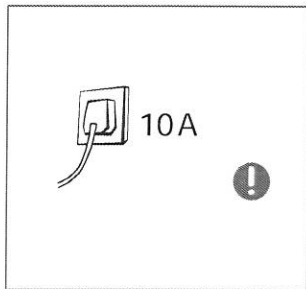

- Please use a dedicated three-hole power socket which is 10A or more and the power socket shall not be shared with other electrical appliances.
- The power cord should be firmly contacted with the socket or else fires might be caused. Please ensure that the grounding electrode of the power socket is equipped with a reliable grounding line.

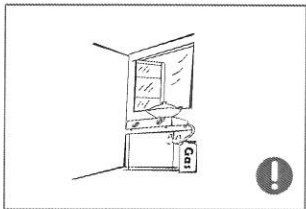

- Please turn off the valve of the leaking gas and then open the doors and windows in case of leakage of gas and other flammable gases. Do not unplug the refrigerator and other electrical appliances considering that spark may cause a fire.

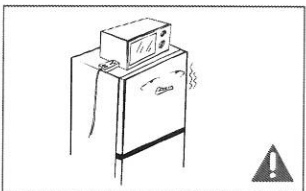

- To ensure safety, it is not recommended that to place regulators, rice cookers, microwave ovens, object and /or containers filled with water, and other appliances at the top of the refrigerator, those recommended by the manufacture are not included.

## ► Related warnings for use

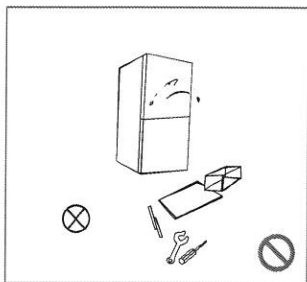

- Authorized demolition or renovation of the refrigerator is not prohibited. It is forbidden to damage the refrigerant lines and the repair and maintenance of the refrigerator must be carried out by professionals.
- Damaged power cord must be replaced by the manufacturer, its maintenance department or related professionals in order to avoid danger.

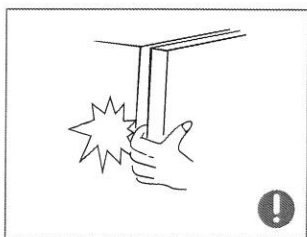

- The surrounding of the appliances around or the embedded structure shall not be obstructed while good ventilation shall be maintained.
- The gaps between refrigerator doors and between doors and refrigerator body are small, be noted not to put your hand in these areas to prevent squeezing the finger. Please be gentle when switching off the refrigerator door to avoid falling articles.
- Do not pick foods or containers in the freezing chamber when the refrigerator is running, especially metal containers in order to avoid frostbite.

# SAFETY INSTRUCTIONS



- Do not allow children to enter or climb the refrigerator to prevent that children are sealed in the refrigerator or children are injured by the falling refrigerator.
- Do not spray or wash the refrigerator; do not put the refrigerator in moist places easy to be splashed with water so as not to affect the electrical insulation properties of the refrigerator.

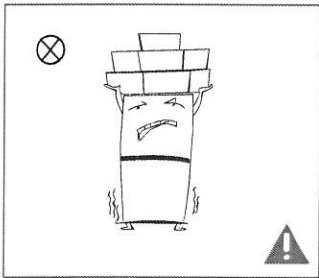

- Do not place heavy objects on the top of the refrigerator considering that objectives may fall when switching the door, and accidental injuries might be caused.
- Please pull of the plug in case of power failure or cleaning. Do not connect the freezer to power supply within five minutes to prevent damages to the compressor due to successive starts.

## ► Warnings related to placing items

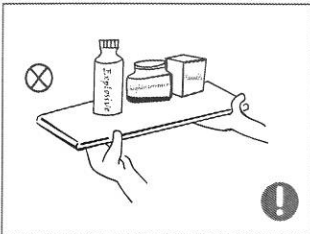

- Do not put flammable, explosive, volatile and highly corrosive items in the refrigerator to prevent damages to the product or fire accidents.
- Do not place flammable items near the refrigerator to avoid fires.

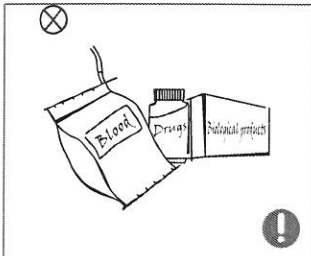

- This product is household refrigerators and shall be only suitable for the storage of foods. According to national standards, household refrigerators shall not be used for other purposes, such as storage of blood, drugs or biological products.

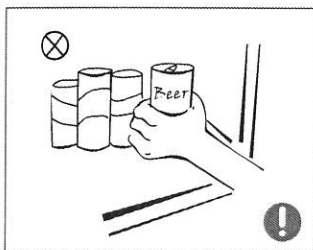

- Do not place items such as bottled or sealed container of fluid such as bottled beers and beverages in the freezer to prevent bursts and other losses.

# INTRODUCTION

## ► Names of components

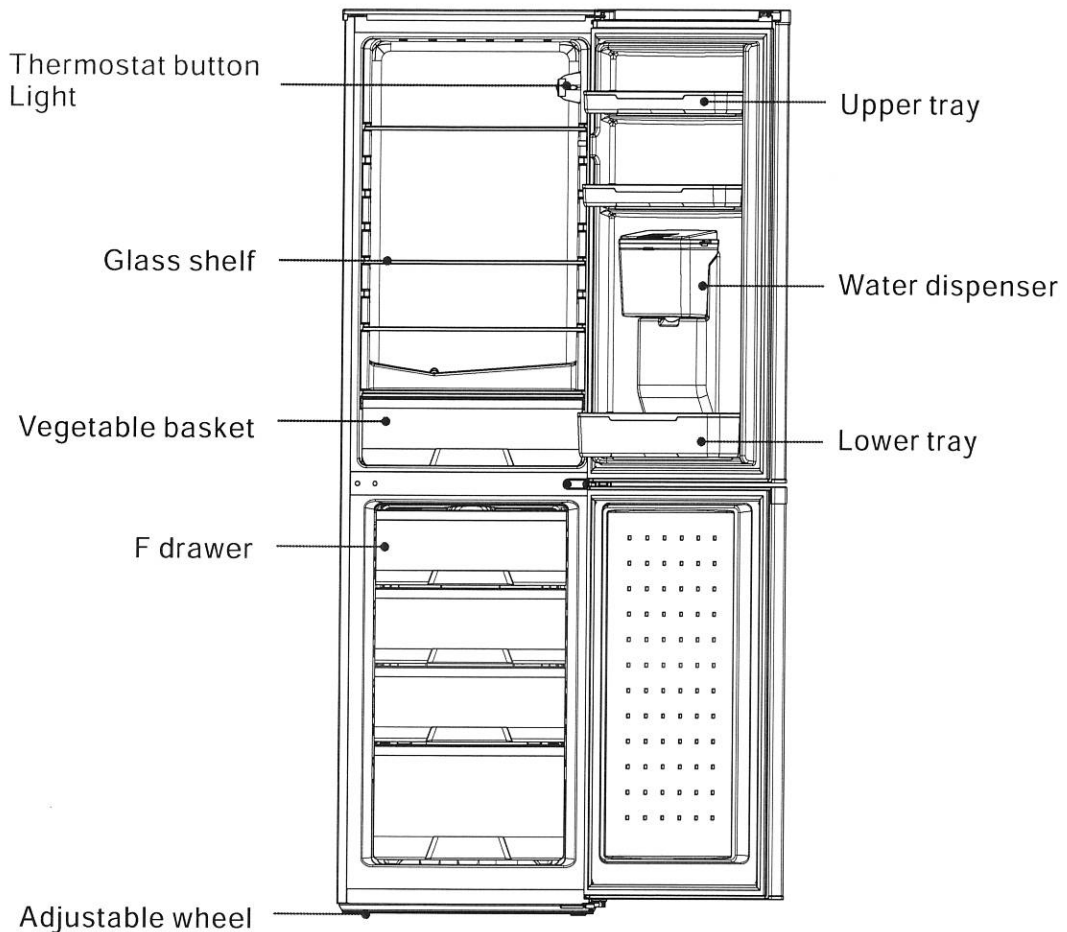

### Refrigerating chamber

- The Refrigerating chamber is suitable for storage of a variety of fruits, vegetables, beverages and other food consumed in the short term.
- Cooking foods shall not be put in the refrigerating chamber until cooled to room temperature.
- Foods are recommended to be sealed up before putting into the refrigerator.
- The glass shelves can be adjusted up or down for a reasonable amount of storage space and easy use.

### Freezing chamber

- The low temperature freezing chamber may keep food fresh for a long time and it is mainly used to store frozen foods and making ice.
- The freezing chamber is suitable for storage of meat, fish, shrimp, dumplings, rice balls and other foods not to be consumed in short term.
- Chunks of meat are preferably to be divided into small pieces for easy access. Please be noted food shall be consumed within the shelf time.

 The features and accessories of the refrigerator you bought may be not entirely consistent with the legend, please refer to the packing list.

# INTRODUCTION

## ► Thermostat

- The temperature selector knob is located on the right hand side wall of the refrigerator interior  
 Setting “Off” : UnitOff  
 Setting “Min” : Less Cool Temperature  
 Setting “Med” : Normal Operation(adequate for most situations)  
 Setting “Max” : Coolest Temperature
- When environment temperatures is high (e.g. on hot summer days), if the thermostat setting is Coolest (positioning MAX), the compressor runs continuously.  
 Reason: when the ambient temperature is high, the compressor runs continuously to maintain the low temperature in the appliance.
- For the first time you install your refrigerator, set the thermostat knob at “Med” .  
 Give your refrigerator time to cool down completely before adding food. It is the best to wait 24 hours before adding food. The thermostat knob controls the temperature. When the thermostat control knob is set to OFF, the refrigerator will not be running.
- The freezing and storage test should be done, according to regulation, removing all drawers except the bottom one.

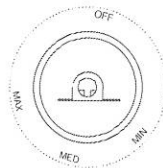

## ► Illuminating lamp and replacement

- If the refrigerator lamps damaged please contact our customer service

## ► Placement

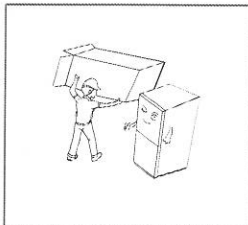

- Before using the refrigerator, remove all packaging materials including bottom cushions and foam pads and tapes inside the refrigerator, tear off the protective film on the door and the refrigerator body.

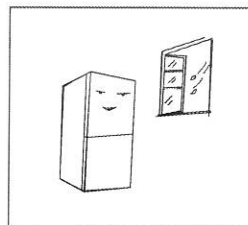

- The refrigerator is placed in a well-ventilated indoor place; the ground shall be flat, and sturdy (rotate left or right to adjust the wheel for leveling if unstable).

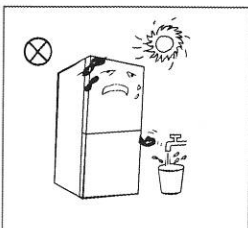

- Keep away from heat and avoid direct sunlight. Do not place the freezer in moist or watery places to prevent rust or reduction of insulating effect.

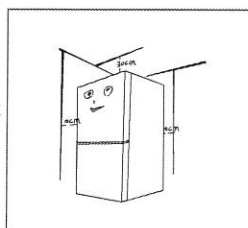

- The top space of the refrigerator shall be greater than 30cm, and the distances from both sides and backside shall be more than 10 cm to facilitate the opening and closing and heat dissipation.
- Wipe the refrigerator inside and outside with warm moist rag (add a small amount of detergent in the warm water and wipe clean finally with clean water).

## ► Start

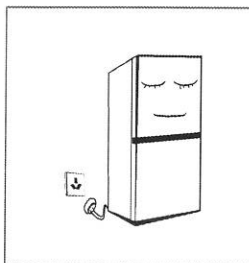

- The refrigerator shall stay for half an hour before connecting 220-240V/ 50Hz power when it is firstly started.
- The refrigerator shall run 2 to 3 hours before loading fresh or frozen foods; the refrigerator shall run for more than 4 hours in summer in advance considering that the ambient temperature is high.

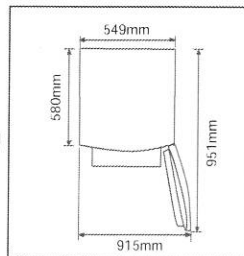

- Please leave enough space to ensure feasible opening and drawer removal.
- Dimensions shown are for reference only.



# INTRODUCTION

## ► Cleaning

- Dusts behind the refrigerator and on the ground shall be timely cleaned to improve the cooling effect and energy saving. The interior of the refrigerator should be cleaned regularly to avoid odor. Soft towels or sponge dipped in water and non-corrosive neutral detergents are suggested for cleaning. The freezer of shall be finally cleaned with clean water and dry cloth. Open the door for natural drying before the power is turned on.



- Do not use hard brushes, clean steel balls, wire brushes, abrasives, such as toothpastes, organic solvents (such as alcohol, acetone, banana oil, etc.), boiling water, acid or alkaline items clean refrigerator considering that this may damage the fridge surface and interior.
- Do not rinse with water so as not to affect the electrical insulation properties. Please use a dry cloth when cleaning lighting lamps, temperature control knob and electrical components.

⚠ Please unplug the refrigerator for defrost and cleaning.

## ► Stop using

Foods can be preserved for a couple of hours even in summer in case of power failure; it is recommended to reduce the frequency of opening door and do not put fresh foods into the freezer.

Please unplug the refrigerator left unused for a long time for cleaning. Keep the door open to avoid the bad odor.

Before moving the refrigerator, please remove all items in the refrigerator and fasten the glass partitions, fruit and vegetable boxes, freezer drawers with taps lest the door opens during displacement; Do not turn upside, horizontally place or vibrate the refrigerator, the carrying angle can not be greater than 45 °.

⚠ Continuous operation is recommended when the refrigerator is started. Please do not move the refrigerator under normal circumstances so as not to affect the refrigerator's service life.

## TROUBLE SHOOTING

- The following simple issues can be handled by the user. Please call the after-sale service department if the issues are not settled.

Inoperation	Whether the product is plugged and connected to power; Failure power or tripping circuit
Odor	Odorous foods should closely wrapped; Whether foods are rotten; Whether the interior shall be cleaned.
Foods in the refrigerating chamber are frozen	Whether the thermostat is over adjusted; Whether foods containing water is put in inside the glass partition.
Long-term operation of compressor	It is normal that refrigerator operates for longer time in summer when the ambient temperature is higher; Do not put too much food in the freezer at one time; Do not put foods until they are cooled; Frequent opening of refrigerator door. Thick frost layer (defrost is needed)
Illuminating light does not shine	Whether the refrigerator is connected to power, whether the illuminating light is damaged.
The refrigerator door can not be properly closed.	The refrigerator door is stuck by food packages; Too much food; Tilt refrigerator.
Loud noises	Whether the food is leveled, whether the refrigerator is balanced; Whether the refrigerator parts are properly placed.

### Warm tips:

- ◆ The refrigerator enclosure may emit heat during operation specially in summer, this is caused by the radiation of the condenser, and it is a normal phenomenon.
- ◆ Condensation: condensation phenomenon will be detected on the exterior surface and door seals of the freezer when the ambient humidity is large, this is a normal phenomenon, and the condensation can be wiped away with a dry towel.
- ◆ Airflow sound: Refrigerants circulating in the refrigerant lines will produce eruption of sound and grunts which is normal does not affect the cooling effect.
- ◆ Buzz: Buzz will be generated by running compressor specially when starting up or shutting down.
- ◆ Clatter: The solenoid valve or electric switch valve will clatter which is a normal phenomenon and does not affect the operation.
- ◆ The refrigerating chamber will periodically frost and defrost (water drops will be generated on the backside of the refrigerating chamber when defrosting) which are normal.

## Door install guidelines about swapping left&right

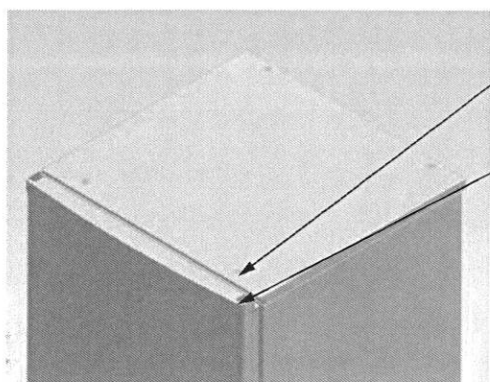

Screw cap (four)

Catch (two)

1. Remove the four screw caps and two catches with the even- slot screwdriver. Then disassemble the screws top the fixed roof with the cross-slot screwdriver.

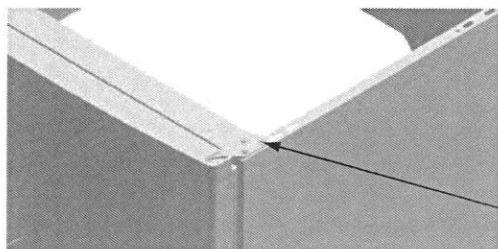

Screw (three)

2. Remove the screws fixed the top-hinge with cross-slot screwdriver.

3. Replace the top-hinge and the top-door limit block and the door bearing bush to the other side.

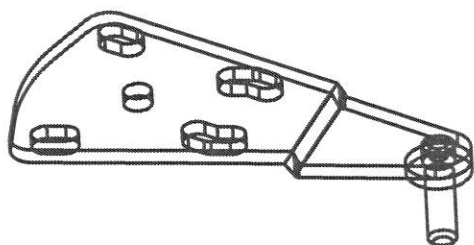

A. Remove the nut with sleeve. Take off the washer then remove the axes to the other side and fixed.

B. Remove the top door limit block

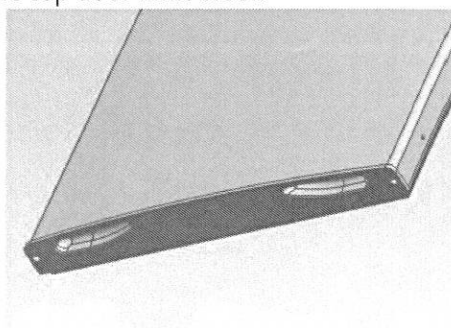
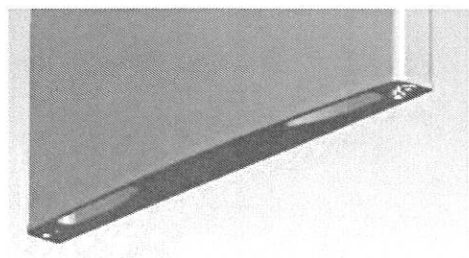

# DOOR REVERSIBILITY

## Door install guidelines about swapping left&right

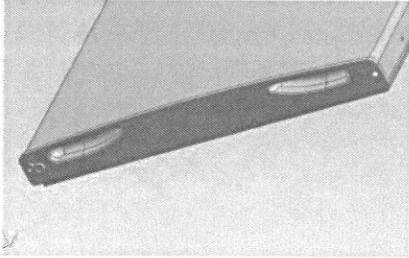

C. Please taking out another door limit block, with screw mounting to the door

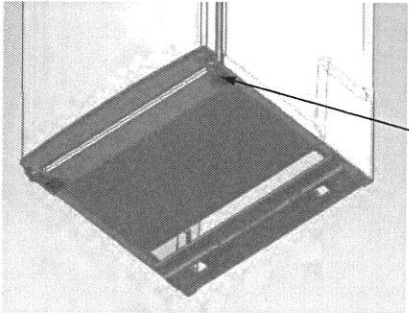

4 Disassemble the screws fixed the bottom-hinge with cross-slot screwdriver

The screws fixed the bottom-hinge

Note the refrigerator-freezer incline angle less 45°.

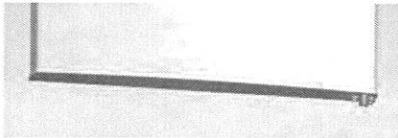

5 Replace the bottom door bearing bush and the limit block

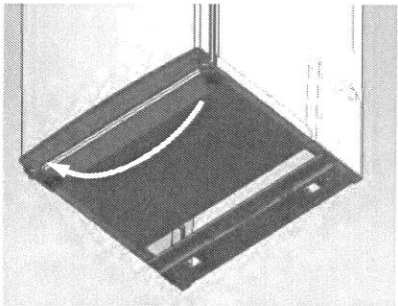

6 Replace the bottom hinge to the other side then fix it with screws.



7 replace the mid-hinge

8 Set the bottom door right position, fix the mid-hinge.

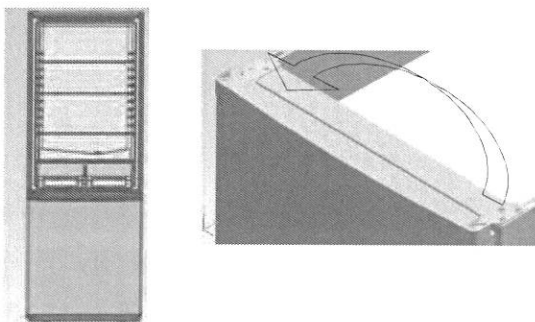

9 replace the top-hinge

## DOOR REVERSIBILITY

### Door install guidelines about swapping left&right

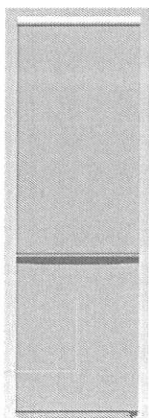

10. Set the top door right position, fix the top-hinge and the cover.

11. Install the four screw caps and two catches to corresponding position.
- Ensure the Appliance is unplugged and empty.
  - Adjust the two leveling feet to their highest position.
  - We recommend you have someone to assist you.

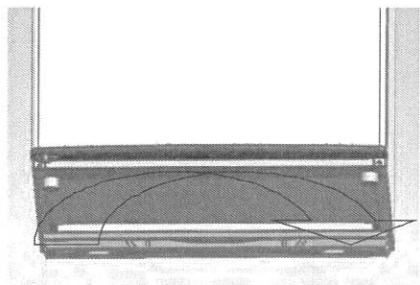

12. replace the leveler to the other side and adjust it to make sure the cabinet level

#### Attachment:

1. Components that could be transferred from one side to the other directly after disassembling are listed below:

top door top endcap coverslip (2pcs)

top cover buckle (1pc)

hinge shaft sleeve (1 or 2pcs)

screws of top hinge (3 pcs)

middle hinge assembly (1 pc)

screws of middle hinge (2 pcs)

insert nail (2 pcs)

screw cap (2 pcs)

door stopper (1 pc)

bottom hinge assembly (1 pc)

screws of lower hinge (3pcs)

2. The component that could be swapped over from one side to the other only after reconstruction is listed below:

top hinge assembly

3. Components that could be swapped over from one side to the other in pairs are listed below:

adjustable foot with internal thread (used with the lower hinge)

adjustable foot with bolt (fixed at the bottom)

4. Components that could not be reused temporarily are listed below:

left block on top door

right block on top door

Ensure the Appliance is unplugged and empty.

Adjust the two leveling feet to their highest position.

We recommend you have someone to assist you.

#### NOTE:

To take the door off it is necessary to tilt the Appliance backward.

You should rest the Appliance on something solid e.g.a chair just below the top panel.

Do not lay the Appliance completely flat as this may damage the coolant system.

## Scrapping old appliance



By ensuring that this product is properly disposed of, you will help prevent potential negative consequences for the environment and human health, which could otherwise arise due to inappropriate waste handling of this product on reaching the end of its working life.

With proper disposal of the appliance, it is possible to recover valuable raw materials! This appliance is marked as conforming to the European Directive 2012/19/EU on Waste of Electrical and Electronic Equipment (WEEE). The symbol on the product indicates that this appliance may not be treated as normal household waste; it must, instead, be delivered over to the nearest collection point for the recycling of electrical and electronic equipment. Disposal must be effectuated in accordance with the environmental regulations in force for waste disposal. For more detailed information about treatment, recovery and recycling of this product, contact the competent public office (Department of Ecology and Environment), your home household waste disposal service, or the shop where you purchased the product. Cut and dispose of the power cord with the plug. Up until appropriate disposal, do not damage the tubing because they contain the refrigerant gas.

For the disposal of packing materials, follow local regulations. WEEE contains both polluting substances (which can cause negative consequences for the environment) and basic components (which can be re-used). It is important to have WEEE subjected to specific treatments, in order to remove and dispose properly all pollutants, and recover and recycle all materials.

Individuals can play an important role in ensuring that WEEE does not become an environmental issue; it is essential to follow some basic rules:

-WEEE should not be treated as household waste. -WEEE should be handed over to the relevant collection points managed by the municipality or by registered companies. In many countries, for large WEEE, home collection could be present.

- when you buy a new appliance, the old one may be returned to the retailer who has to collect it free of charge on a one-to-one basis, as long as the equipment is of equivalent type and has the same functions as the supplied equipment.

## INSTRUCTIONS FOR THE WATER DISPENSER

1. The water dispenser can be used only for purified water. Hot water, soft drinks containing carbon dioxide such as cola, fruit juice, etc. are not applicable;
2. The water injection by taking down the water box from the door is not allowed;
3. The maximum water injection rate shall be lower than the maximum scale indicated on the water box;
4. In case of failure of water taking, please inspect if the water box is normally located on its base;
5. Please confirm that the water tank is empty before moving;
6. The water valve components are non-detachable;
7. If the water dispenser is used for the first time, or it has been kept unused for long period, then it needs to be disassembled and cleaned before water taking and drinking;
8. If the water in the water tank is not used for long period, then it is suggested that the water in water dispenser shall be drained and then the clean drinking water shall be added;
9. It is suggested that the mechanism of the water dispenser shall be cleaned once in every 3-6 months;
10. If the cleaning solution is used for cleaning water dispenser, then it is suggested that, before the water taking and drinking, the water shall be drained to the amount of 5-6 cups after the water tank is installed back, so as to avoid the residue cleaning solution.
11. Upon opening/closing the door, do not apply excessive force to prevent water from overflow due to water sloshing inside the tank.

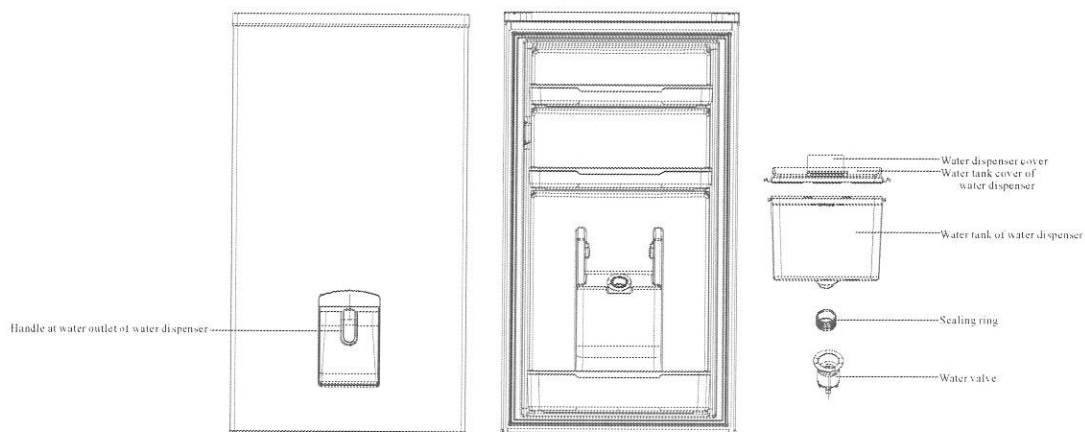

### Filling of drinking water:

Open the water tank cover and directly fill the water;

### Attentions:

1. Only purified water and cool water without any impurities can be used for water dispenser. The hot water and soft drink with carbon dioxide, likes cola, apple juice and so on can not be used;
2. The water injection by taking down the water box from the door is not allowed;
3. The maximum water injection rate shall be lower than the maximum scale indicated on the water box;
4. Do not knock on the bottle frame in upward side during the filling of water.

### Water taking and drinking:

1. Push the handle to inner side by using the water glass;
2. The water flows out when the handle is pushed to inner side; and the outflow stops when the handle returns to the original place;

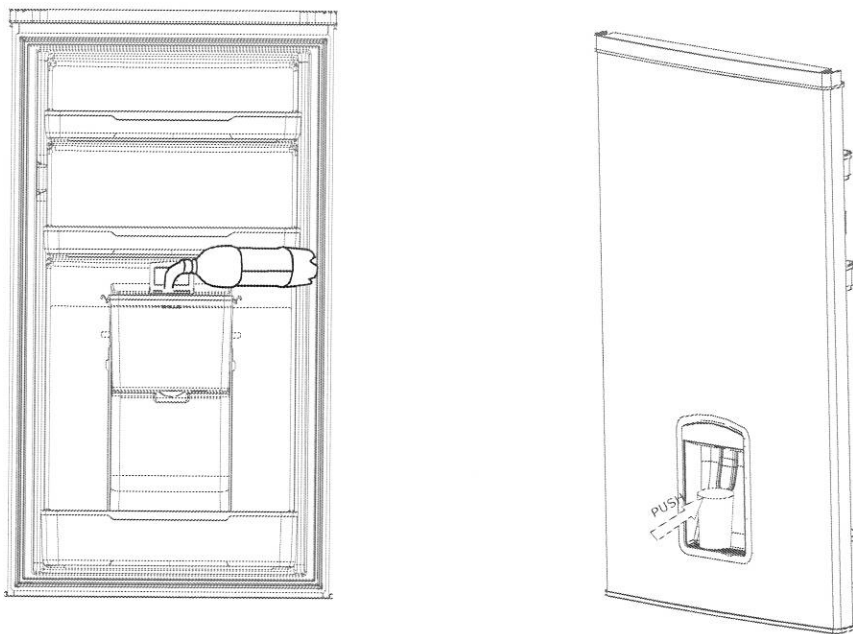

### Attentions:

1. If the water in the water tank is not used for long period, then it is suggested that the water in water dispenser shall be drained and then the clean drinking water shall be added;
2. If the water dispenser is used for the first time, or it has been kept unused for long period, then it needs to be disassembled and cleaned before water taking and drinking;
3. In case of failure of water taking, please inspect if the water box is normally located on its base;



## Instructions for water dispenser disassembly and cleaning

### I. Disassembly

#### 1. Take out the water tank components

To pull out the water tank components in the direction of 45° of oblique upward by hands that are closely attached on the two sides of the water tank components, when the lower parts of water tank components are separated from the water valve components, the water tank components can be taken out through horizontal movement (to the direction of user);

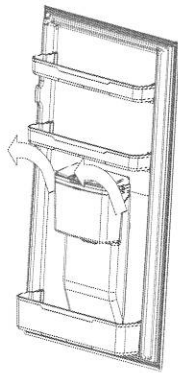

#### 2. Take down the sealing ring of water tank

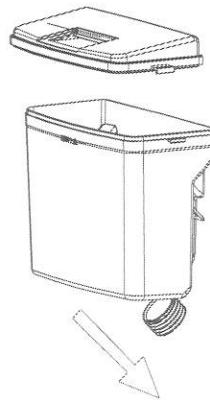

#### 3. Disassembly of water valve components

Use the (screwdriver), and its tool edge shall be in alignment with and inserted in the vacancy at the skirt border, which is bulged at the top of water valve components, then rotate the screwdriver clockwise or anticlockwise, after the rotation, use the tool bit to open the water valve and then pull out the water valve components in the direction of 45° of oblique upward by hands.

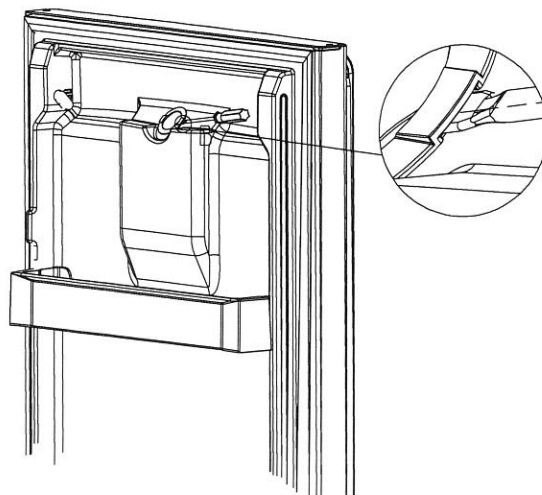

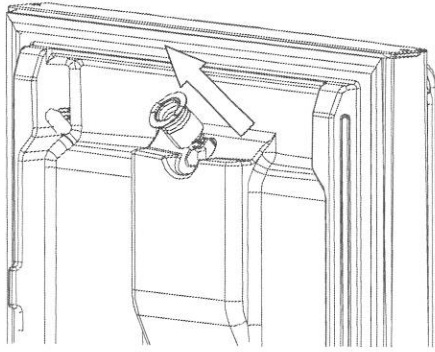

**Attentions: Make sure that the water tank is empty before moving it.**

1. The water valve components are non-detachable;

## II. Cleaning

1. To disassemble the water tank, water tank cover, sealing ring and water valve;
2. Use cold or warm water to cleaning the components of water dispenser.
3. Wipe it with dry cloth.

### Attentions:

1. If the cleaning solution is used for cleaning water dispenser, then it is suggested that, before the water taking and drinking, the water shall be drained to the amount of 5-6 cups after the water tank is installed back, so as to avoid the residue cleaning solution.

## III. Installation

1. Installation of water valve components

The guiding boss on the water valve components shall be in alignment with the guiding slot on the base, and press it down in the direction of in the direction of 45° of oblique downward by hands with strength, until you may hear the sound of "lick".

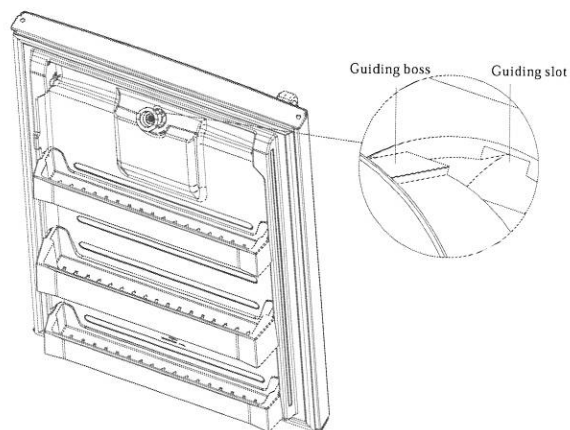

2. Installation of water tank sealing ring

To install the sealing ring on the bottom of water tank by hand, make sure that it is properly installed, and the wrinkling and oblique installation and so on shall be avoided.

### 3. Installation of water tank components

The hanging slot on the water tank components shall be in alignment with the suspension loop on the inner layer, and the sealing ring at the bottom of water tank shall be in alignment with the entrance of water valve components, and then insert them into the corresponding positions in the direction of 45° of oblique downward by hands.

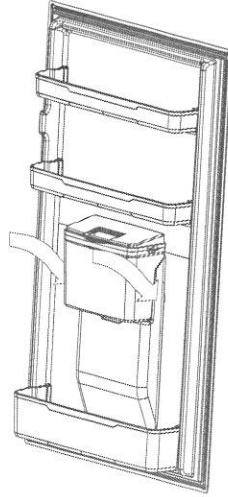

### Cleaning of water receiving tank

Use wet cloth to wipe it and then use the dry cloth.

## Tips for energy saving

Try not to open the door too often, especially when the weather is wet and hot. Once you open the door, close it as soon as possible.

Every now and then check if the appliance is sufficiently ventilated (adequate air circulation behind the appliance).

In normal temperature conditions, please arrange the thermostat at the middle setting.

Before loading the appliance with packages of fresh food, make sure they are cooled to ambient temperature.

Ice and frost layer increase energy consumption, so clean the appliance as soon as the layer is 3-5 mm thick.

The appliance should be located in the coolest area of the room, away from heat producing appliances or heating ducts, and out of the direct sunlight.

Let hot foods cool to room temperature before placing in the appliance. Overloading the appliance forces the compressor to run longer. Foods that freeze too slowly may lose quality, or spoil.

Be sure to wrap foods properly, and wipe containers dry before placing them in the appliance. This cuts down on frost build-up inside the appliance.

Appliance storage bin should not be lined with aluminum foil, wax paper, or paper toweling. Liners interfere with cold air circulation, making the appliance less efficient.

Organize and label food to reduce door openings and extended searches. Remove as many items as needed at one time, and close the door as soon as possible.