



Block up to 100% of Nuisance Calls

Quick Set-up and User Guide



BT8600 Advanced Call Blocker
Digital Cordless Phone with Answering Machine

Powered by
trueCall
STOPS NUISANCE CALLS

Check box contents



Handset



Base

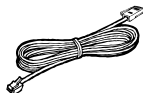

Telephone line cord
(pre-installed)

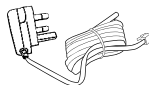

Mains power adaptor
(item code 066270)



2 x AAA Ni-MH 750 mAh
rechargeable batteries
(already in handset)

Contents for each additional handset (multipacks only)



Handset



Charger

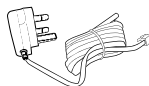

Mains power adaptor
(item code 066270)



2 x AAA Ni-MH 750 mAh
rechargeable batteries
(already in handset)

! Important

Only use the mains power adaptors, cables and rechargeable batteries supplied in this box or this product might not work. Any replacement rechargeable batteries must be of the same type. BT accepts no responsibility for damage caused to your BT8600 if you use any other type of batteries.

Contents

Quick set up	5	Store a contact (up to 200).....	34
Getting to know your phone		View/dial a contact	34
Finding your way around your phone.....	15	Caller Display and the Calls list	35
Handset buttons	16	View and dial from the Calls list... 35	
Base.....	17	Save a Calls list entry to your contacts.....	36
Using the phone		Set the time and date.....	37
BT Call Guardian	18	Set Parental control	37
The Block button	20	Answer machine	38
Call Control.....	28	Message playback using the handset.....	38
Making calls	32	Message playback using the base	40
Make an external call	32	Help	41
End a call.....	32	General information	
Receive a call.....	32	Guarantee	42
Mute.....	23	How to recycle your equipment ..	42
Incoming speech / Handsfree volume.....	33	R&TTE Directive & Declaration of Conformity	42
Make a handsfree call.....	33		
Contacts.....	34		

If you need some help, call us on **0800 145 6789*** or go to **bt.com/producthelp**

Menu map

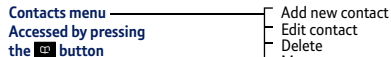
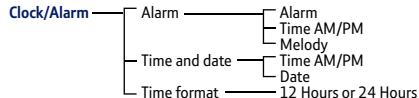
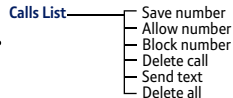
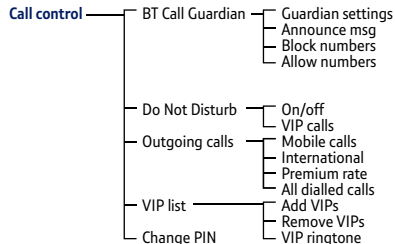
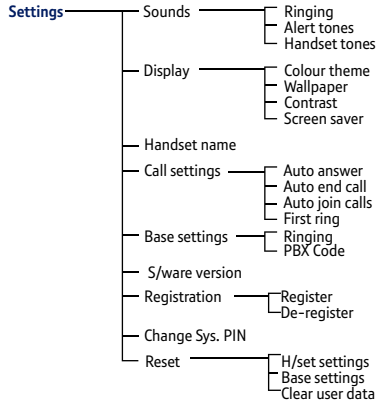
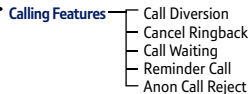
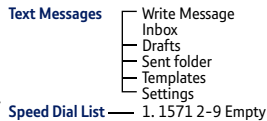
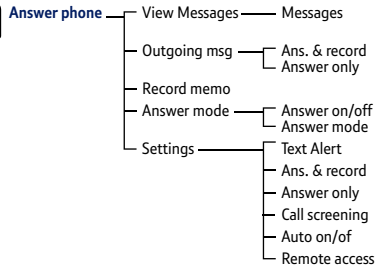

If you need some help, call us on **0800 145 6789*** or go to **bt.com/producthelp**

Quick set up guide

1 Plug in

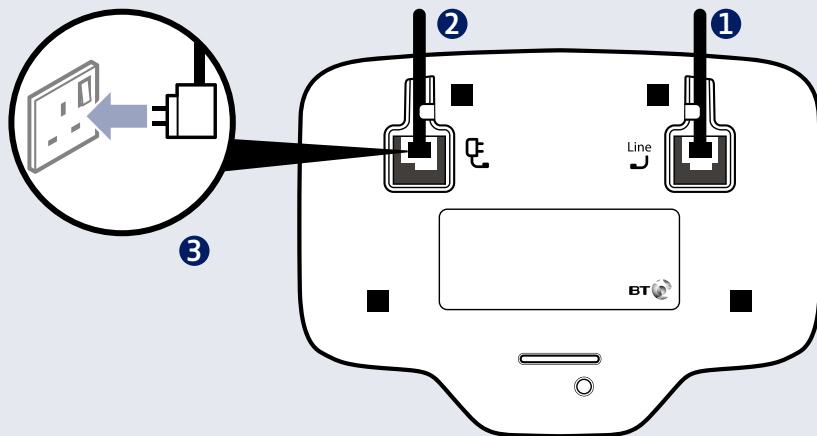

- 1 The telephone line cord is already fitted but **don't** plug the other end into the wall socket yet.
- 2 Plug the mains power adaptor into the base, with the cable clipped in the groove provided.
- 3 Plug the other end of the power adaptor into the wall power socket and switch on.

2 Activate the batteries

1. Activate the batteries by pulling the plastic tab away from the bottom of the handset.



2. The BT logo will appear on the screen, followed by the set up wizard screen displaying **Please set the time and date to start using your telephone**. Don't follow these instructions yet. Place your handset on the base to charge first.

3 Charge

Place the handset on the base and leave to charge for **24 hours**.

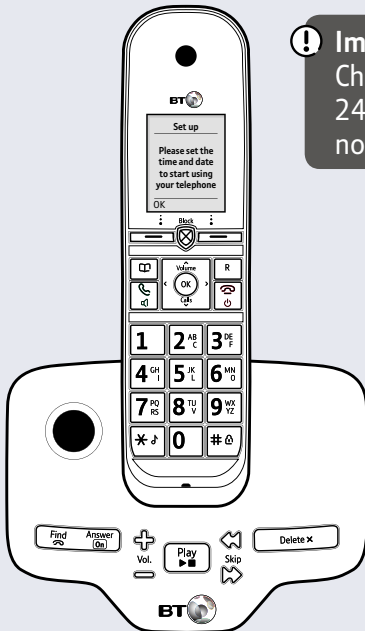

! **Important**
Charge the handset batteries for 24 hours or your phone might not work.



! If your screen displays this message, don't worry. This is normal and will continue to be displayed until you connect the phone line cord in Step 4.

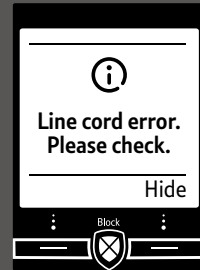

4 Connect the phone line cord

After 24 hours, plug the phone line cord into the phone wall socket.

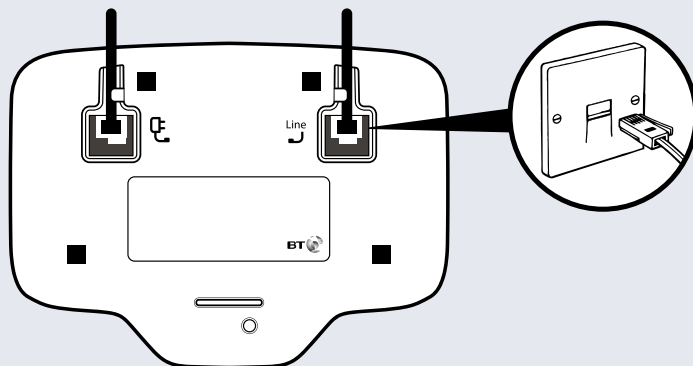

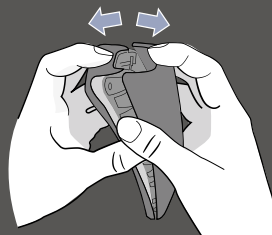

! If you ever need to remove the batteries, place your fingers in the groove at the bottom of the handset and lift the cover up to release it. Then, gently ease the batteries out.







5 Follow the set up wizard

Set the time and date

1. Select **OK** by pressing the Left option button  under the screen. The set up wizard will begin. Follow the prompts to complete the set up process.

 **Tip:** when prompted to select **OK** you can press the  button in the centre of the keypad if you prefer.

2. Use the keypad to enter the time using the 12 hour clock format e.g. for **3:32 pm** you need to enter **03:32**.
3. Press  press  or  to select **AM** or **PM**.
4. Press  enter the date in the format **DD/MM/YYYY**.
5. Press **Save**. **Saved** is displayed.

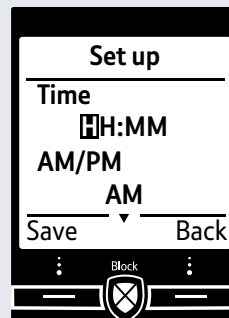
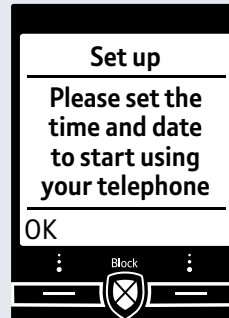

10 Quick set up guide

BT Call Guardian

- Continue to read and follow the prompts.
- Press **OK**.
- Press **OK**.

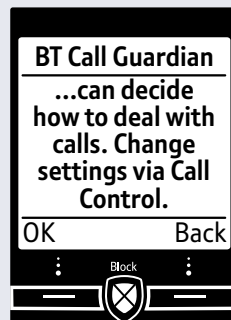

 You need to have a Caller Display service from your network provider to use all the features available e.g. Call Guardian, Visual Voicemail, Calls List, Text Messaging and other Caller Display enabled features. Charges may apply.

- Select **Yes** or **No**, and follow the prompts.

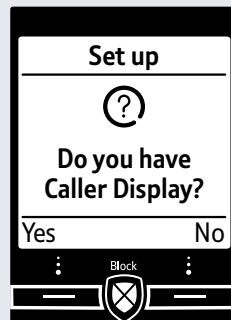

Complete the set up tasks

10. If you wish to continue following the set up wizard, select **Yes**. (If you don't want to follow the wizard, select **No** and you can start using your phone straight away. You can always set up tasks via the menu later).

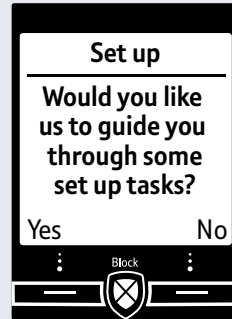

Record your answer phone outgoing message

11. If you wish to complete this step, select **Yes** (or **No** to continue to the next step).
12. **Record message** is highlighted, press **Select**.
13. Follow the voice prompt and record your message into the phone after the tone.
14. Select **Save** when you've finished.
15. Your message will be played back to you.
16. Select **OK** (or **Delete** if you want to replace it).
17. Select **Done**, to continue with the set up wizard.

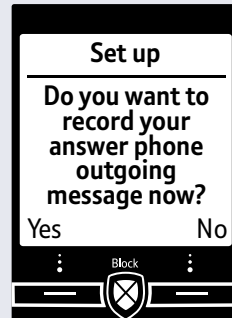

12 Quick set up guide

Add contacts

18. If you want to add some contact numbers now, select **Yes** (or select **No** to continue to next step).

By adding contacts, you will always know that their calls will get straight through to you, without the need to go through BT Call Guardian.

Please make sure you always add the full telephone number when you save a contact. If you have important numbers that will always need to get through e.g Doctors surgery, National Floodline, Carer Line numbers etc, make sure you've added them to your Contacts or Allowed list.

19. Enter the contact name using the keypad and press **Calls**.
20. Enter the home phone number. You can then press **Calls** and enter a mobile number and then a work number if you want to. Press **Calls** then **<** or **>** to select a ringtone.
21. Select **Save** when you've finished.

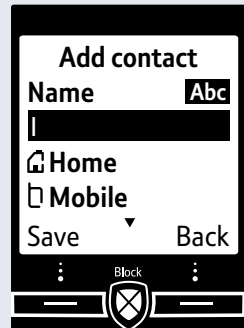
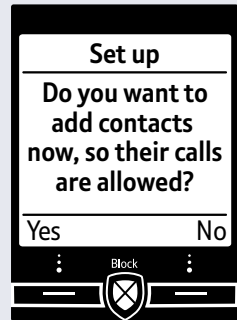

22. Select **Yes** if you want to enter more contacts or **No** if you don't want to for now.
Follow steps 19, 20 and 21 on page 12 for instructions on how to add a contact.

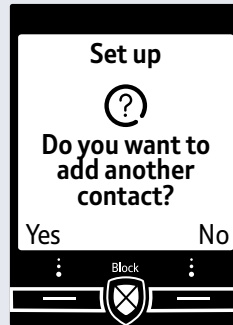

23. Select **OK** to complete the set up wizard.
You can now start using your phone.

Please read the rest of this User Guide for instructions on how to use the most popular features of your BT8600 phone.

If you'd like more detailed instructions on features like internal calls, remote access and text messaging, further information is available to download from bt.com/producthelp

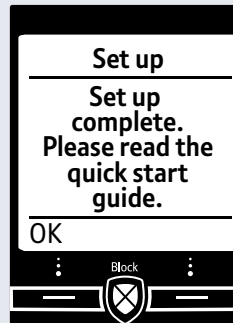

6 Set up your additional handsets (multi packs only)

1. For additional handsets and chargers: plug the mains power adaptor into the back of the charger and plug the other end into the mains wall socket and switch on the power.

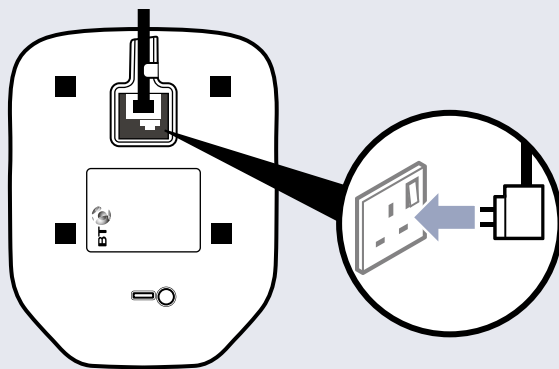









2. Activate the batteries as explained on page 6. Once you've set the time and date on the first handset then it will be shared with all other handsets in your multi pack after you activate the batteries.
3. Place the handset on the charger to charge for 24 hours.

Getting to know your phone

Finding your way around your phone

Your BT8600 has an easy to use menu system.

When the handset is switched on and at the idle screen:

1. Select **Menu** by pressing the Left option button  to open the main menu.
2. Use the  or  button to scroll through the available menu options.
3. When the menu you want is displayed, select by pressing the Left option button  or press .
4. Use the  or  button to scroll through the available sub menu options. When the sub menu you want is highlighted, select by pressing the Left option button  or press .

Select the **Back** option if you want to return to the previous screen.

To exit a menu and return to the home screen, press .

If no buttons are pressed for 30 seconds, the handset returns to the home screen automatically.

Use the  to access the BT Call Guardian settings.

16 Getting to know your phone

Handset buttons

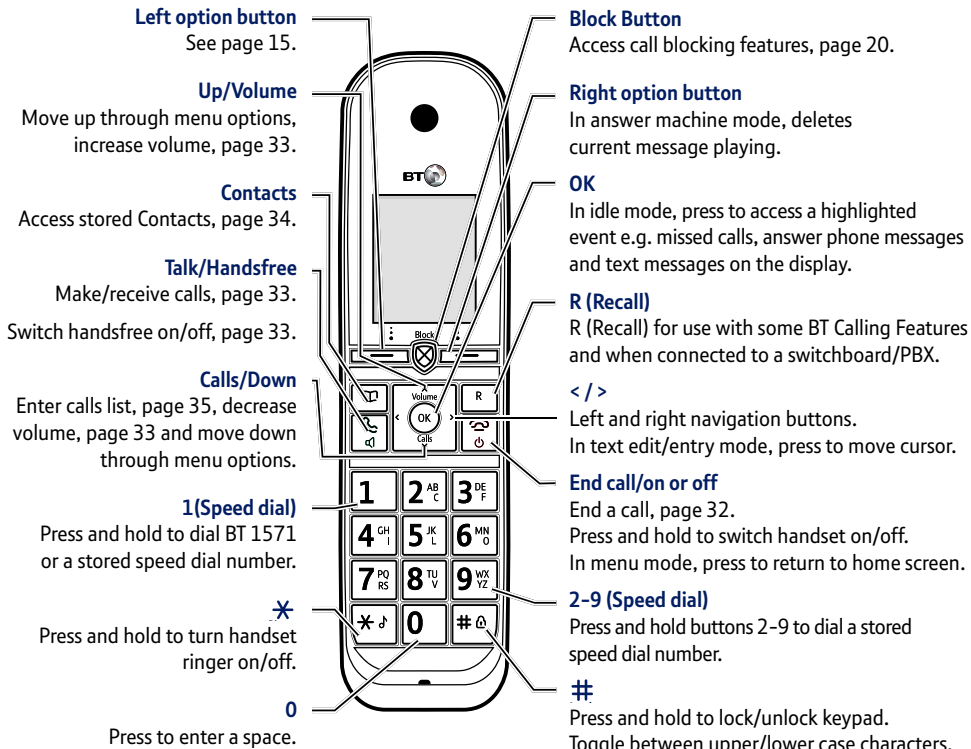

If you need some help, call us on **0800 145 6789*** or go to **bt.com/producthelp**

Base

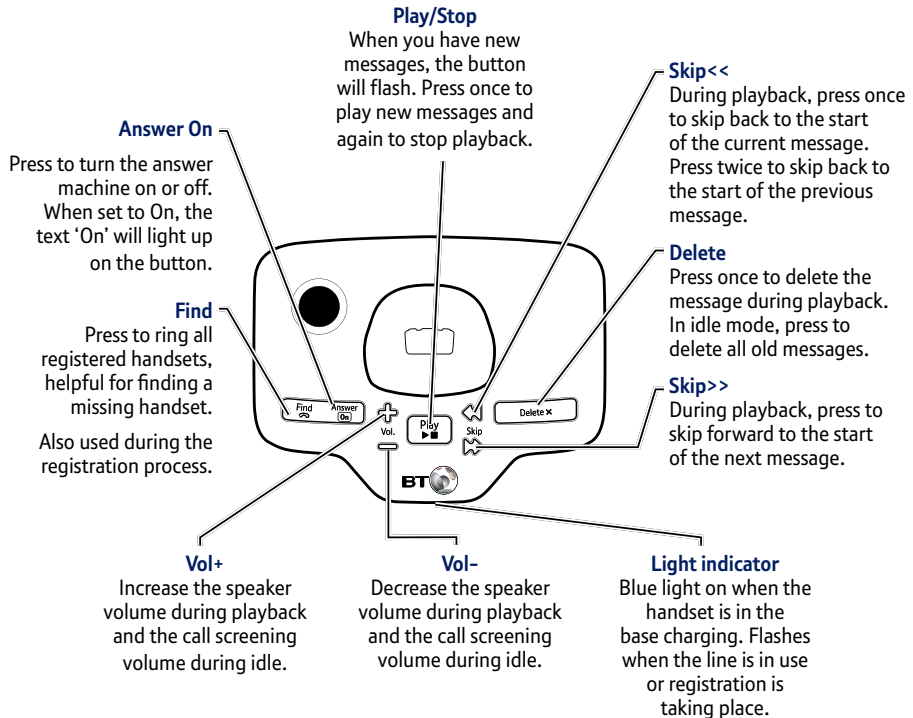

BT Call Guardian

You need Caller Display







This will help you get the most out of your BT Call Guardian. You can get this from your phone service provider. Charges may apply.

Your BT8600 has four Guardian modes that allow you to easily manage incoming calls in different ways:

- **Announce** – All calls not in your Contacts, Allow or VIP list must say their name. Those on your Blocked list hear, “Calls to this number are being screened by BT Call Guardian, the person you are calling is not accepting your call. Please hang up”.
 - **International** – All calls from International numbers must announce their name. All other calls, except those on your blocked list hear the message above and all other calls come straight through.
 - **Ans Phone** – All calls not in your Contacts, Allowed or VIP list are sent straight to the Answer Phone including those on your Blocked list.
 - **Custom** – You choose how you’d like to handle all of your calls.
-  In **Announce mode** (default setting), the BT8600 will filter all first time calls from numbers that are not yet saved in your Contacts, or already on your allowed list. By doing this, you gradually build up these lists and your phone will know how to deal with the call the next time it comes in.

Personalise your announce message

You can personalise the BT Call Guardian greeting, by adding your name to the Announce message.

1. Select **Menu**, scroll  to **Call Control** and press **Select** or .
2. Follow the instructions to set your PIN or enter your PIN and select **OK**.
3. **BT Call Guardian** is highlighted, press **Select** or .
4. Scroll to **Announce msg**, press **Select** or .
5. Press **Select**, or , on **Record name** and follow the voice prompt and press **Save**.
6. If you are happy with your recording, press .

How do you accept, block or send a call to the answer phone?

1. BT Call Guardian answers a call for you and asks the caller to say (“announce”) who they are.
2. Your BT8600 then rings you with the Announced call on the display and announces the caller’s name when you pick up the phone. (e.g. “You have a call from Mark”).
3. You now have the following choices :
 - To accept the call, press 1
 - To always accept their calls, press 2
 - To block their calls, press 3 or press 
 - To send this call to the answer phone, press 4
 - Or to ignore the call, just hang up (this call will then be sent straight to the answer phone)

If you need some help, call us on **0800 145 6789*** or go to bt.com/producthelp

The Block button

The block call button can be used in 3 ways:

1. Incoming call

When you have an incoming call, the handset display will show 'Announced call'. When you pick up the handset you'll hear the caller announcement so you can decide whether to take the call. If you don't want to take the call, press  on the handset and the caller will be advised that their call is not accepted and the call will be disconnected.

The number will be blocked and added to the blocked calls list if Caller ID is displayed. If the number calls again, the caller will hear, "Calls to this number are being screened by BT Call Guardian, the person you are calling is not accepting your call. Please hang up".

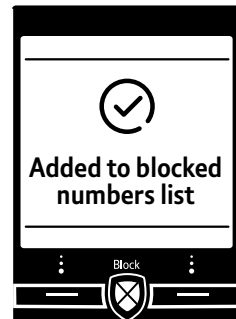
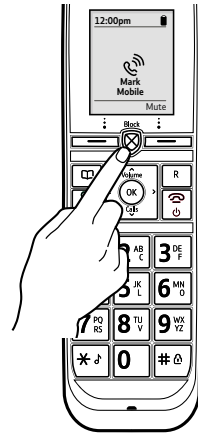

2. During a call

If you have already answered the call and you want to block the number press . If the number is displayed you have the option to select **Yes** and the number will be added to the blocked numbers list and the call will end. Or select **No** to go back to the caller.



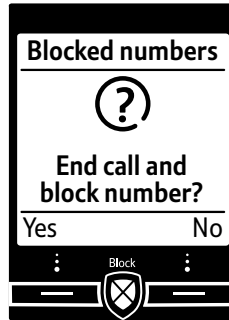

3. In idle mode

Press  as a shortcut to the Call Control menu. See page 28.



How do I change the different BT Call Guardian modes?

You can change the default setting of Announce mode to International, Answer phone or Custom:

1. In idle mode, press .
2. Follow the instructions to set your PIN or enter your PIN and select **OK**.
3. **BT Call Guardian** is highlighted, press **Select** or .
4. Scroll  to Guardian mode and then use the  or  to select the one that you want to change (e.g. International) and press **Save**.



Custom mode

Once you get used to your phone, you might decide to customise your settings depending on the call type. For example, you can allow unknown numbers but block international numbers and send withheld numbers to the answer phone.

 **Remember:** settings will be the same as the last mode you selected, unless you save your own custom options.

Here's how to customise settings for certain types of call

Take care when doing this, as it changes your phone's BT Call Guardian settings.

1. In idle mode, press .
2. Follow the instructions to set your PIN or enter your PIN and select **OK**.
3. **BT Call Guardian** is highlighted, press **Select** or **OK**.
4. Scroll  to **Guardian settings** and press **Select** or **OK**.
5. Scroll  to **Announce** then press **←** or **→** to find **Custom**.
6. Press **Save** and scroll to find the type of call that you want to want to change the settings for. You can change :
Blocked / Allowed / International / Withheld / Payphones / Mobile /
Unavailable /
All other numbers.
And for each of these, you have the choice to: Block / Ans.phone /
Allow / Announce.
7. Select **Save**.

Switch BT Call Guardian on/off

When Call Guardian is set to On, it is On for whichever mode you're using (e.g Announce mode). If you turn Call Guardian Off, all calls will be allowed through, even if they are already on your blocked list.

1. In idle mode, press .
2. Call Guardian settings are PIN protected, so follow the instructions to set your PIN or enter your PIN and select **OK**.

If you need some help, call us on **0800 145 6789*** or go to bt.com/producthelp

3. **BT Call Guardian** is highlighted, press **Select** or **OK**.
4. **Guardian settings** is highlighted, press **Select** or **OK**.
5. Press **⏏** or **⏏** to switch BT Call Guardian on/off.
6. Select **Save**.

What happens when you allow a number (caller)

Any numbers in your phone's Contacts are automatically allowed to come straight through to you to answer. To block a contact, see page 20.

- When you get an allowed call, you'll see the caller's number (if available) with the call type below it on your phone's screen.
- If you don't answer a call from an allowed number, it will go through to your answer phone (if it's on) or eventually it will hang up if unanswered.

 **Remember:** if you've allowed a contact, all the numbers you have for a contact will also be allowed.

What happens to my VIP numbers?

These are always allowed to come through to you. If you want BT Call Guardian to look after any of these numbers, you'll need to remove them from your VIP list and then adjust your BT Call Guardian settings for that number.

What happens when you block a number (caller)

You can block a whole number or part of it (e.g. you can block by area codes).

To unblock or allow a blocked number, see page 27.

- A caller calling from a blocked number will hear a message telling them that their call has been blocked.
- You'll see the caller's number (if available) in the Calls list with [Blocked call icon]. This means that BT Call Guardian is blocking the call without you having to do anything.

 **Remember:** if you've blocked a contact, all the numbers you have for a contact will also be blocked.







Calls that are always allowed

'Ringback' calls and calls from the operator are always allowed, and you can't block these using BT Call Guardian.

How to add numbers straight to your Blocked and Allow lists



Aside from adding numbers to your Block and Allow list as calls come through, you can also add numbers directly to the lists via your Call Control menu.

To add a number to the block list







1. In idle mode, press .
2. Follow the instructions to set your PIN or enter your PIN and select .
3. **BT Call Guardian** is highlighted, press **Select** or .
4. Scroll  to **Block numbers** and press **Select** or .
5. **Add number** is highlighted, press **Select** or .
6. Enter the telephone number you want to block (make sure you enter the full dialling code) and press **Save**.

To block numbers by area code

You can also block numbers by area code. This will mean that any calls beginning with that code, will be blocked. Follow the instructions above from 1 to 4 and then:

5. Scroll  to **Area codes**, press **Select** or .
6. On first use, you will see **No area codes stored. Add code?** Select **Yes**.
7. Add the area code (e.g. 01473) and press **Save**.

To add a number to the allow list

1. In idle mode, press .
2. Follow the instructions to set your PIN or enter your PIN and select .
3. **BT Call Guardian** is highlighted, press **Select** or .
4. Scroll  to **Allow numbers** and press **Select** or .
5. **Add number** is highlighted, press **Select** or .
6. Enter the telephone number you want to allow (make sure you enter the full dialling code) and press **Save**.

Deleting your blocked and allowed lists











When in the Block and Allow number menu's above, you also have the choice to delete the whole list. Remember, if you do this, all calls previously blocked and allowed, will now come back through your BT Call Guardian settings.

Call control settings

! To enter the Call control menu you need to enter your remote access PIN. This will need to be set the first time you try and enter the menu, simply follow the on screen instructions. If you have already changed the remote access PIN when setting your remote access then you will not need to set it again as this PIN is used for both Call control and Remote access.







Set-up Do not disturb

Do not disturb allows calls to be received silently with minimal notification. The default is off.

1. In idle mode, press .
2. Enter the access PIN and select . Scroll  to **Do Not Disturb** and press **Select**.
3. Press  or  to select **On**, **Off** or **Timed**. If you select **Timed** you need to select the on and off times you want, press  and enter the on time, then  again and enter the off time. Press  to highlight whether you want VIP calls to be **Allowed** or **Barred** using  or , then press **Save**. The chosen setting will be displayed and you will hear a confirmation tone.

 When set to On, the idle screen will display **DO NOT DISTURB** instead of the handset name. For more information and general advice on handling unwanted calls please go to bt.com/unwantedcalls

Set Outgoing calls control

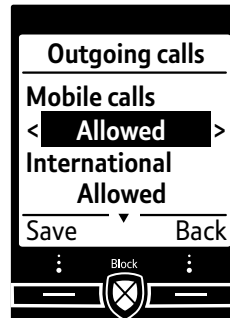

1. In idle mode, press .
2. Enter the access PIN and select . Press  to highlight **Outgoing calls** and press **Select**.
3. **Mobile calls** is highlighted. Press  or  to select **Allowed** or **Barred** for **Mobile calls**, then press  to **International** and follow the same procedure for each option displayed and then select **OK**. The display will show **Outgoing calls settings saved**. You will then be prompted to add some VIPs if you haven't already assigned any.



 If 'All dialled calls' is set to **Barred**, this will take precedence over the other settings except emergency numbers 999 and 112 which can still be dialled. If set to **Allowed**, the status of the other settings will manage which calls can be made. The default for all **Outgoing calls** settings is **Allowed**.



Assign VIPs

You can set whether calls from VIPs will still be allowed to ring or not when the Do not disturb feature is turned on. The default setting is Allowed. If set to Not Allowed all calls will be presented silently. If set to Allowed calls from VIPs will ring as normal.

1. In idle mode, press .
2. Enter the access PIN and select **OK**. Press  to highlight **VIP list** and press **OK**.
3. Read the prompt and select **Info**, read the message and select **Yes** at the end. Your contacts list will be displayed.
4. To assign contacts as VIP, highlight the contact and press . Select additional contacts if required by repeating above.
5. Select **Options**, **Add selected** will be highlighted, press **Select** and the selected entries will be added to your VIP list.

 If you've already added contacts to your VIP's, the list will be displayed when you enter the VIP list menu. You can then select **Options** to add further VIPs, remove VIPs or assign a VIP ringtone.

Change the access PIN

1. In idle mode, press .
2. Enter the existing 4 digit remote access PIN. Press  to highlight **Change PIN** and press **OK**.
3. Once you've read the reminder message, select **OK** then enter the existing 4 digit access PIN and select **OK**.
4. Enter the new 4 digit access PIN and select **OK**, then enter it again when prompted and select **OK**. **Access PIN saved** will be displayed.



Using the phone

Making calls

Make an external call

1. Press .
2. When you hear the dial tone, enter the number.

End a call

1. Press . Or, press  to end the call and add the caller's number to the blocked numbers list.

Receive a call

When you receive a call, the phone rings and the display shows **Incoming call** and .

If you've got a caller display service, the display shows the incoming call, caller's number (if available) or the caller's name.

1. Press  to accept the call.

Mute

1. During a call, select **Mute** by pressing the Right option button. The display shows **Call muted** and your caller can't hear you.
2. Select **Unmute** to return to your caller.

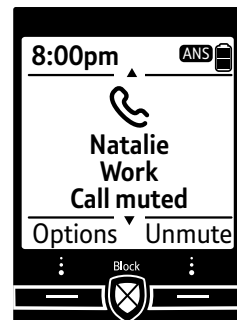

Incoming speech / Handsfree volume

1. Press **Volume** or **Calls** to increase or decrease the volume.

Subsequent presses will change the volume, you will hear the volume level with each press.

- ⓘ** From the idle screen, you can press **Volume** to change the Ringer volume settings too.

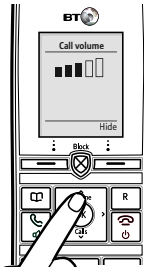



Make a handsfree call

1. Enter the number then press **OK** twice. **☎** is displayed. You hear your call over the handset loudspeaker.
2. Press **☎** to switch the call between the earpiece and the loudspeaker.
3. Press **☎** to end the call.





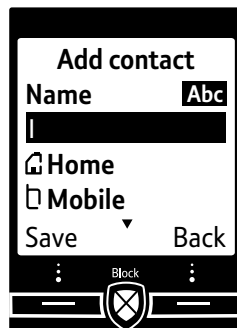

Contacts

Store a contact (up to 200)

1. From the idle screen, press .
2. Select **Options**. **Add contact** is highlighted, press **Select**.
3. Enter the new contact name using the keypad then press  and enter the home phone number. You can then press  and enter a mobile number and then a work number if you want to. Select **Save** when you've finished. The display will show **Contact saved**.



View/dial a contact

1. From the idle screen, press  to open your contact list.
2. Press  or  to scroll through and view the entries.
3. To dial an entry, press  when the entry is highlighted. If the entry has more than one number saved under it you will need to highlight the number you want and then press  again.

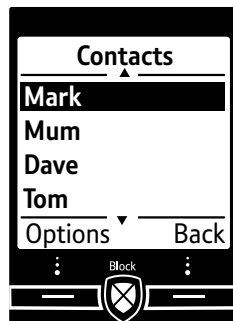

Caller Display and the Calls list

! For Block Calls, Caller Display and the Calls list, you must subscribe to a Caller Display service for these features to work. Your network provider may charge you for this service.

View and dial from the Calls list (up to 50 incoming and 30 outgoing calls)

1. Press **Calls** or select **Calls**. The most recent entry is at the top of the list. (If there are no entries **List empty** will be displayed.)
2. Press **Volume** or **Calls** to scroll through and view the list.
3. To dial an entry, when the entry you want is highlighted, press **Call**.

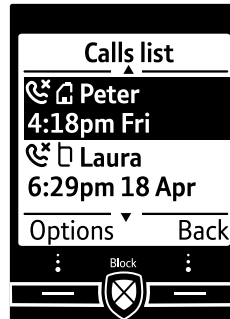



36 Using the phone

Save a Calls list entry to your contacts

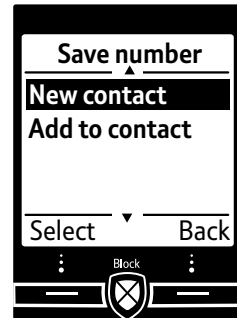
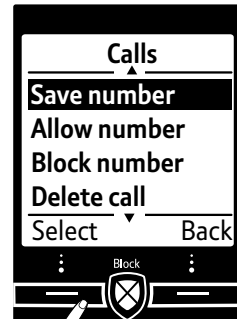
1. Press **Calls**, then press **Volume** or **Calls** to highlight the entry you want and select **Options**.
2. Highlight **Save number** and press **Select**.
3. You now have two options:
 - i) To save this as a new contact, highlight **New contact** and press **Select**. Highlight the type of number, then press **Select**. Enter the contact name and select **Save**.
 - ii) To add to an existing contact, highlight **Add to contact** and press **Select**. Scroll to highlight the entry you want and press **Select**. Highlight the number type where you want to save the number (Home, Work or Mobile) and press **Select**.



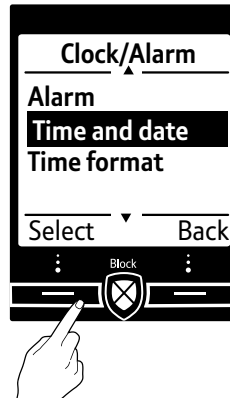

Set the time and date

1. Select **Menu**, scroll  to display **Clock/Alarm** and press **Select**.
2. Press  to highlight **Time and date** and press **Select**.
3. Enter the digits for the time, (you will also need to select AM or PM if 12 hour format has been set using **<** or **>**). Then press  and enter the date. Select **Save**.



Set Parental control

1. Select **Menu**, scroll  to **Call Control** and press **Select**.
2. Enter the access PIN and select **OK**. Press  to highlight **Parental Control** and press **Select**.
3. Press **<** or **>** to select **Allowed** or **Barred** for **Mobile Calls**, then press  and follow the same procedure for **International**, **Premium rate** and **All dialled calls** then select **Save**. The display will show **Parental control settings saved**. You will then be prompted to add some VIPs if you haven't already assigned any.

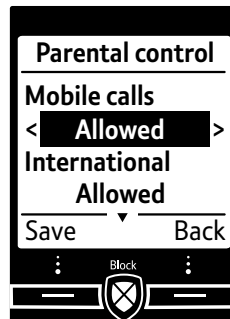

Answer machine

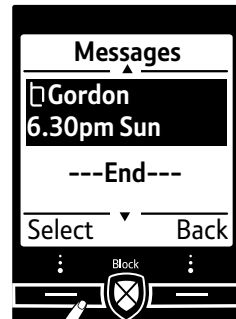
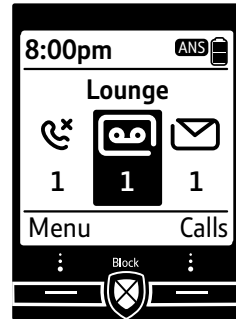

Message playback using the handset

1. Highlight the answer phone icon on the idle screen and press **OK**, or
 - i. Select **Menu**, **Answer Phone** is displayed, press **Select**.
 - ii. **View Messages** will be displayed, press **Select**.
2. A list of your answer phone messages will be displayed with the most recently received highlighted at the top.
3. Use **Volume** or **Calls** to scroll through the list to highlight the message you wish to listen to and press **OK**.
 - i. If you have more than one message stored and want to listen to them all, select **Options**.
Play all will be highlighted, press **Select**.





4. As each message is played, the handset will display the number or the name if you have Caller Display and a name/number match and the time and date it was received. If you have any old (already listened to) messages these will be played after your new messages.

During playback you have the following options:

 or  to adjust the playback volume.

 to switch private playback through the handset to handsfree playback.

1 or  once to repeat the current message playing from the beginning.

4 or  twice within a second to skip back to the previous message.

6 or  once to skip forward to the next message.

Delete or **3** to delete the current message playing.

At the end of playback, you will hear, “End of messages,” and the same message will be displayed. The answer phone icon on the idle screen will be renumbered to take into account any deleted messages.

Message playback using the base

Press . If you have messages they will be played, new (unplayed) messages first followed by old (played) messages.

During playback:

Press  to stop playback. The base will return to idle.

Press  to delete the message being played.

Press  to skip forward to the start of the next message.

Press  to skip back to the start of the current message.

Press  twice to skip back to the start of the previous message.

Press  to increase or  to decrease the playback volume level.

At the end of playback the base will return to idle mode and messages will be renumbered to take into account any deleted messages.

Phone doesn't work

- Have you activated the batteries correctly? See page 6.
- Check that the mains power is correctly connected.

No dial tone or line cord error message displayed on screen

- Is the telephone cord plugged into the base and phone wall socket?
- Check that the mains power is correctly connected.
- Only use the telephone cord supplied with the phone.

Can't make or receive calls

- Check that the mains power is correctly connected.
- The batteries may need recharging.
- Check that product call barring is not active – see Parental control on page 37.
- Has there been a power cut? If so, place the handset back on the base for ten seconds and try again. If it still doesn't work, disconnect the batteries and mains power for ten minutes, then reconnect and try again.

You have a dial tone, but the phone won't dial out

- If you're connected to a switchboard, check whether you need to dial an access code, see the full user guide, go to bt.com/producthelp.

Handset doesn't ring

- The ringer volume may be switched off, see page 33.
- Check that the mains power is correctly connected.
- Do Not Disturb may be switched on, see the full user guide, go to bt.com/producthelp.
- Block nuisance calls may be switched on, see page 23.
- Make sure the handset is registered to the base, see the full user guide, go to bt.com/producthelp.

If you need some help, call us on **0800 145 6789*** or go to bt.com/producthelp

General information

For information on safety instructions, cleaning, technical information or connecting to a switchboard, please refer to the 'General Information' section in the full user guide at bt.com/producthelp

Guarantee

Your BT8600 is guaranteed for a period of 12 months from the date of purchase.

Subject to the terms listed below, the guarantee will provide for the repair of, or at BT's or its agent's discretion the option to replace the BT8600, or any component thereof, (other than batteries), which is identified as faulty or below standard, or as a result of inferior workmanship or materials. Products over 28 days old from the date of purchase may be replaced with a refurbished or repaired product.

The conditions of this guarantee are:

- The guarantee shall only apply to defects that occur within the 12 month guarantee period.
- Proof of purchase is required.
- The equipment is returned to BT or its agent as instructed.

This guarantee does not cover any faults or defects caused by accidents, misuse, fair wear and tear, neglect, tampering with the equipment, or any attempt at adjustment or repair other than through approved agents. This guarantee does not affect your statutory rights.

To find out what to do, if your phone is in or outside of the 12 month guarantee, please look in the full user guide at bt.com/producthelp

How to recycle your equipment

The symbol shown here and on the product means that the product is classed as electrical or electronic equipment, so DO NOT put it in your normal rubbish bin.



It's all part of the Waste Electrical and Electronic Equipment (WEEE) Directive to recycle products in the best way – to be kinder to the planet, get rid of dangerous things more safely and bury less rubbish in the ground.

You should contact your retailer or supplier for advice on how to dispose of this product in an environmentally friendly way.

Caution

Don't immerse batteries in water, throw them into a fire or dispose of them with ordinary domestic refuse.

BT accepts no responsibility for damage caused to your BT8600 by using any other types of batteries.

There is a risk of explosion if incorrect batteries are fitted.

- Use only the approved rechargeable batteries supplied.
- Never dispose of batteries in a fire. there is a serious risk of explosion and/or the release of highly toxic chemicals.

If you need some help, call us on **0800 145 6789*** or go to bt.com/producthelp

Warning

You won't be able to call 999 from this phone if there's a power cut, so make sure you've got another way to call for help in an emergency.

R&TTE Directive & Declaration of Conformity

This product is intended for use within the UK for connection to the public telephone network and compatible switchboards.

This equipment complies with the essential requirements for the Radio Equipment and Telecommunications Terminal Equipment Directive (1999/5/EC).

For a copy of the Declaration of Conformity please refer to **[bt.com/producthelp](https://www.bt.com/producthelp)**

For a Better Future

We're always looking to make our products last longer and use less power, so we don't have such a big impact on the environment.

To find out about what we are doing, visit
bt.com/betterfuture



Offices worldwide

The services described in this publication are subject to availability and may be modified from time to time. Services and equipment are provided subject to British Telecommunications plc's respective standard conditions of contract. Nothing in this publication forms any part of any contract.

© British Telecommunications plc 2015.
Registered Office: 81 Newgate Street, London EC1A 7AJ.
Registered in England No. 1800000.
Printed in China.

Designed by The Art & Design Partnership.

Available in other formats including braille, large print or audio CD.
If you would like a copy, please call 0800 145 6789*.

* Calls made from within the UK mainland network are free.
Mobile and international call costs may vary.

BT8600 (11/15) Issue 1

