

**GB**  
English

**GB**

## FTVF XT 75B

## TUMBLE DRYER

 This symbol reminds you to read this booklet.

! Keep this instruction booklet on hand in order to refer to it when necessary. Take it with you when you move, and should you sell this appliance or pass it on to another party, make sure that this booklet is supplied along with the dryer so that the new owner may be informed about warnings and suggestions on how the appliance works.

! Read these instructions carefully; the following pages contain important information on installation and suggestions on how the appliance works.

## Contents

### Installation, 2-3

- Where to put your dryer
- Ventilation
- Electrical connection
- Levelling
- Before you start using your dryer

### Warnings, 4-5

- General safety
- To minimise the risk of fire

### Maintenance and Care, 6

- Switching off the electricity
- Cleaning the filter after each cycle
- Check the drum after each cycle
- Cleaning the dryer

### Dryer description, 7

- The front
- The back
- Control panel

### The Display, 8

### Start and programmes, 9-13

- Choosing a programme
- Programmes Table
- The Controls

### Laundry, 14

- Sorting your laundry
- Wash care labels
- Drying times

### Troubleshooting, 15

### Service, 16

- Spare Parts
- Recycling and Disposal

### Product data, 17

**To activate your free\* 5 Year Parts Guarantee  
Call free on 0800 519 2102**

\*Labour charges not included. Terms and conditions apply. Lines open 364 days a year. Calls are free from a BT landline. Charges from other providers and mobiles may apply.

# Installation

GB

## Where to put your dryer

- Place your dryer at a distance from gas ranges, stoves, heaters, or cook tops because flames can damage the appliance.

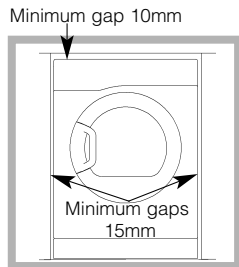

- If you are going to install the appliance under a work counter, be sure to leave a 10mm space between the top and any other objects on or above the machine and a

15mm space between the sides and lateral furnishings or walls. This is to ensure proper air circulation. Make sure that the back vents are not obstructed.

- Make sure you put your dryer in an environment that is not damp and has proper air circulation throughout, the dryer will not operate efficiently in an enclosed space or cupboard.

! We do not recommend that the dryer is installed in a cupboard but the dryer must never be installed behind a lockable door, a sliding door or a door with a hinge on the opposite side to that of the dryer door.  
! The appliance must be installed with the rear surface placed against a wall.

## Ventilation

The Dryer dries your laundry by drawing in cool, clean and relatively dry air, heating it, and then distributing it through the clothes as they are gently tumbled. For optimum performance, the moist air is then blown out through a vent tube at the back of the dryer. When the dryer is in use, there has to be adequate ventilation to avoid the back flow of gases into the room from appliances burning other fuels, including open fires.

## Mobile venting

A vent tube must always be fitted when the dryer is used in conjunction with Mobile Venting. The tube must be fitted securely into the back of the dryer (*see Dryer Description*). If possible, it is always best to connect the tube to a permanent outlet close to the dryer. If permanent installation is not possible, the dryer will work just as well with the tube passing through a partly-opened window.

! Ensure that the end of the tube is not directed toward the air intake vent at the rear of the dryer.

! The vent tube should not exceed 2.4 metres in length and should be kept free of any possible accumulation of fluff, lint and water by shaking it out frequently. Always ensure that the tube is not squashed.

## Permanent venting

In conjunction with the vent tube we recommend using a Wall/Window Vent Kit, available at a retail location or the nearest Spare Parts Dealer.

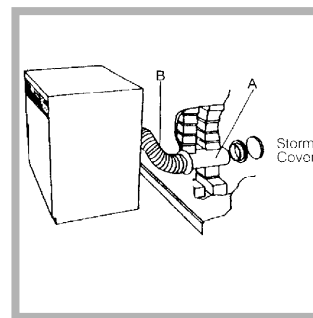

## Wall mounting

1. Leave an opening in the wall to the left of the dryers proposed position.
2. Keep the tube as short and straight as possible to prevent condensed moisture from backing up into the dryer.
3. Similarly, the duct in the wall should slope downwards towards the outside.

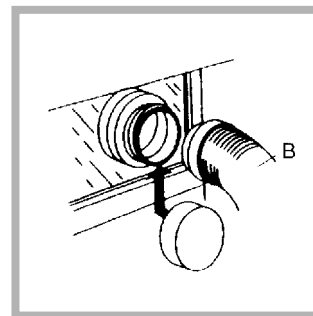

## Window mounting

1. With a stacked dryer the hole in the window should ideally be made below the vent.
2. The tube should be kept as short as possible.

Depending on how often you use your dryer, it is essential that areas A and B are checked periodically to remove lint or debris.

The vent tube adaptor must be fitted securely thus preventing any humid air from being emitted back into the room.

! The Dryer should not be pushed so far back that the tube adaptor is pulled out of position or the tube is squashed or bent.

! The tube should be kept clear of the air intake vent and kinks or 'U' bends must be avoided as these will obstruct the tube or trap condensation.

## Open window venting

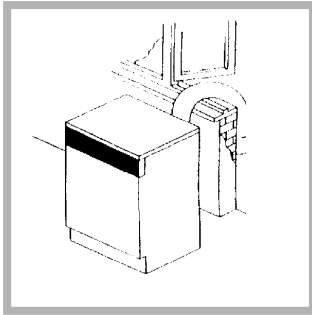

The end of the tube should be directed downwards, to prevent warm moist air from condensing in the room or in the dryer.

! Ensure that the dryer is adequately ventilated and that the end of the vent tube is not directed towards the air intake duct.

! The vent tube must always be fitted for optimum performance.

! Make sure that the vent tube and air intake vents are not obstructed or blocked.

! The dryer must not recycle exhaust air.

! Misusing a tumble dryer may create a fire hazard.

! Do not discharge exhaust air into a flue which is used for exhaust fumes from other appliances that burn gas or other fuels.

! Do not discharge exhaust air into an extraction system or any duct with an extractor fan. This will affect the way the thermal controls operate and can result in a fire hazard.

## Electrical connections

Make sure of the following before you insert the plug into the the electrical socket:

- Make sure your hands are dry.
- The socket must have an earth connection.
- The socket must be able to sustain the machines maximum power, which is indicated on the rating label (*see Dryer Description*).
- Power voltage must be within the values indicated on the rating label (*see Dryer Description*).
- The socket must be compatible with the dryers plug. Should this not be the case, replace the plug or the socket.

! The dryer must not be installed outdoors, even if the space is sheltered. It can be very dangerous if it is exposed to rain or storms.

! Once installed, the dryers electrical wire and plug must be within easy reach.

! Do not use extension cords.

! The power cord must not be bent or squashed.

! The power cord should be regularly checked. If the supply cord is damaged, it must be replaced by the manufacturer, its service agent or similarly qualified persons in order to avoid a hazard. New or longer power cords are supplied at an extra charge by authorised dealers..

! The manufacturer denies any responsibility should any of these rules not be followed.

! If in doubt about any of the above consult a qualified electrician.

## Levelling your dryer

The dryer must be installed level for correct operation.

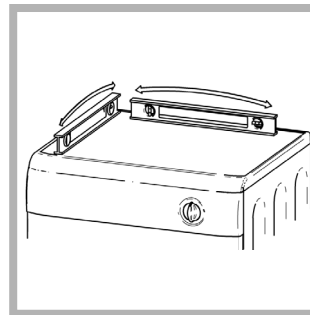

When you have installed your dryer in its final location check that it is level first side to side, then front to back.

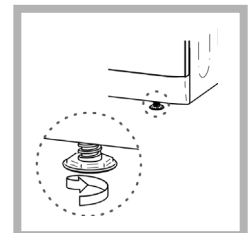

If the dryer is not level, use a wooden block to support it while adjusting the two front legs up or down, until your dryer is level.

## Before you start using your dryer

Once you have installed your dryer and before you use it, clean the inside of the drum to remove any dust that could have accumulated during transport.

## Maximum load

Natural fibres : 7 kg

# Warnings

GB

! The appliance has been designed and built according to international safety standards. These warnings are given for safety reasons and must be followed carefully.

## General safety

- This appliance can be used by children aged from 8 years and above and persons with reduced physical, sensory or mental capabilities, or lack of knowledge if they are given supervision or instruction concerning use of the appliance in a safe way and understand the hazards involved.
- This tumble dryer has been designed for home, and not professional use.
- Do not touch the appliance while bare foot or with wet hands or feet.
- Unplug the machine by pulling on the plug, not the cord.
- After using the dryer, turn it off and unplug it. Keep the door closed to make sure that children do not use it as a toy.
- Children should be supervised to ensure that they do not play with the dryer.
- Cleaning and user maintenance should not be made by children without supervision.
- Children of less than 3 years should be kept away from the appliance unless continuously supervised.
- The appliance must be installed correctly and have proper ventilation. The air intake vents behind the machine, the outlet vents and the vent tube should never be obstructed (*see Installation*).
- Never direct the vent tube outlet towards the air intake at the back of the machine.
- Never allow the tumble dryer to recycle exhaust air.
- Never use the dryer on carpeting where the pile height would prevent air from entering the dryer from the base.
- Check to see if the dryer is empty before loading it.
-  The back of the dryer could become very hot. Never touch it while in use.
- Do not use the dryer unless the filter is securely in place (*see Maintenance*).
- Do not overload the dryer (*see Laundry* for maximum loads).
- Do not load items that are dripping wet.
- Carefully check all instructions on clothing labels (*see Laundry*).
- Do not tumble dry large, very bulky items.
- Do not tumble dry acrylic fibres at high temperatures.
- Do not turn off the dryer when there are still warm items inside.
- Clean the filter after each use (*see Maintenance*).
- Do not allow lint to collect around the dryer.
- Never climb on top of the dryer. It could result in damage.
- Always follow electrical standards and requirements (*see Installation*).
- Always buy original spare parts and accessories (*see Service*).

**To minimise the risk of fire in your tumble dryer, the following should be observed:**

- Tumble dry items only if they have been washed with detergent and water, rinsed and been through the spin cycle. It is a fire hazard to dry items that HAVE NOT been washed with water.
- Do not dry garments that have been treated with chemical products.
- Do not tumble dry items that have been spotted or soaked with vegetable or cooking oils, this constitutes a fire hazard. Oil-affected items can ignite spontaneously, especially when exposed to heat sources such as a tumble dryer. The items become warm, causing an oxidation reaction with the oil, Oxidation creates heat. If the heat cannot escape, items can become hot enough to catch fire. Piling, stacking or storing oil-affected items can prevent heat from escaping and so create a fire hazard. If it is unavoidable that fabrics containing vegetable or cooking oil or those that have been contaminated with hair care products be placed in a tumble dryer they should first be washed with extra detergent - this will reduce, but not eliminate the hazard. They should not be removed from the dryer and piled or stacked while hot.
- Do not tumble dry items that have previously been cleaned in or washed in, soaked in or soiled with petrol/gasoline, dry cleaning solvents or other flammable

- or explosive substances. Highly flammable substances commonly used in domestic environments including cooking oil, acetone, denatured alcohol, kerosene, spot removers, turpentine, waxes and wax removers. Ensure these items have been washed in hot water with an extra amount of detergent before being dried in the tumble dryer.
- Do not tumble dry items containing foam rubber (also known as latex foam), or similarly textured rubber like materials. Foam rubber materials can, when heated, produce fire by spontaneous combustion.
  - Fabric softener or similar products should not be used in a tumble dryer to eliminate the effects of static electricity unless the practice is specifically recommended by the manufacturer of the fabric softener product.
  - Do not tumble dry undergarments that contain metal reinforcements eg. bras with metal reinforcing wires. Damage to the tumble dryer can result if the metal reinforcements come loose during drying.
  - Do not tumble dry rubber, plastic articles such as shower caps or babies water proof covers, polythene or paper.
  - Do not tumble dry rubber backed articles, clothes fitted with foam rubber pads, pillows, galoshes and rubber coated tennis shoes.
  - Remove all objects from pockets, such as lighters and matches.

**! WARNING:** Never stop the dryer before the end of the drying cycle unless all items are quickly removed and spread out so that the heat is dissipated.

# Maintenance and Care

GB

## Switching off the electricity

Unplug your dryer when not using it, when cleaning it and during all maintenance operations.

## Clean the filter after each cycle

The filter is an important part of your dryer: it accumulates lint and fluff that is formed while drying.

Small items could also become trapped in the filter.

When finished drying, therefore, clean the filter by rinsing it under running water or with your vacuum cleaner. Should the filter become clogged up, the airflow inside the dryer will be seriously compromised: drying times lengthen and you will consume more energy. It may also damage your dryer.

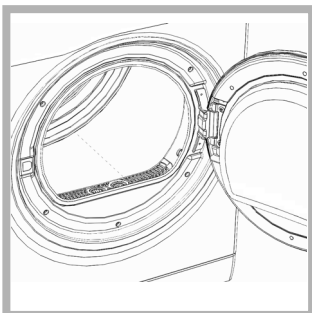

The filter is found in front of the dryer trim (*see diagram*).

Removing the filter:

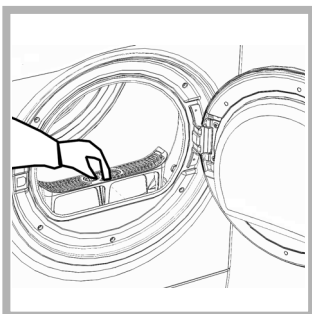

1. Pull the plastic grip of the filter upwards (*see diagram*).

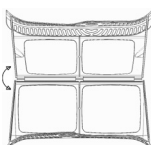

2. Open the filter and clean the lint from the inside.

3. Replace it correctly. Ensure the filter is fully located flush into the tumble dryer trim.

4. Remove any lint that has built up on the inside of the door and around the door seal.

! Do not use the dryer without replacing the filter.

## Check the drum after each cycle

Turn the drum manually in order to remove small items (handkerchiefs) that could have been left behind.

## Cleaning the drum

! Do not use abrasives, steel wool or stainless steel cleaning agents to clean the drum.

A coloured film may start to appear on the stainless steel drum, this may be caused by a combination of water and, or cleaning agents such as fabric conditioner from the wash. This coloured film will not affect the dryer performance.

## Cleaning

- External parts in metal or plastic and rubber parts can be cleaned with a damp cloth.
- Periodically check the vent tube and any permanent venting fixture to make sure that there has been no accumulation of fluff or lint, and remove it.
- Remove lint that collects around the filter and the outlet vents.

! Do not use solvents or abrasives.

! Have your dryer checked regularly by authorised technicians to ensure electrical and mechanical safety (*see Service*).

# Dryer Description

## The front

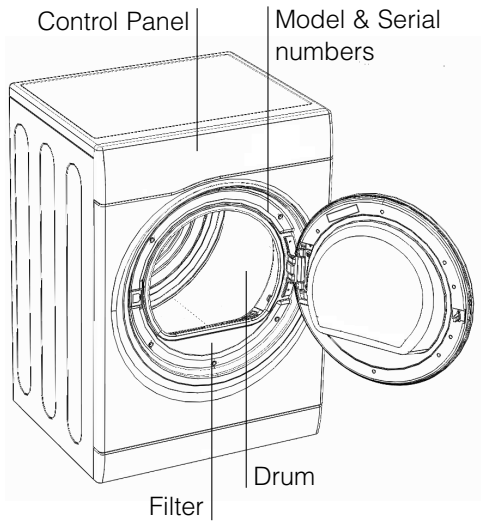

## The back

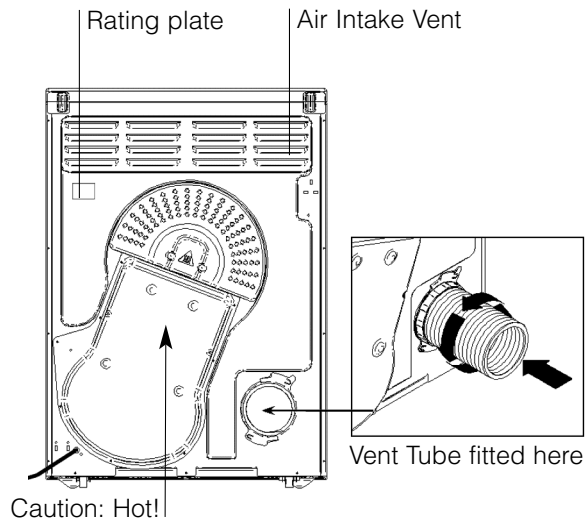

## Control panel

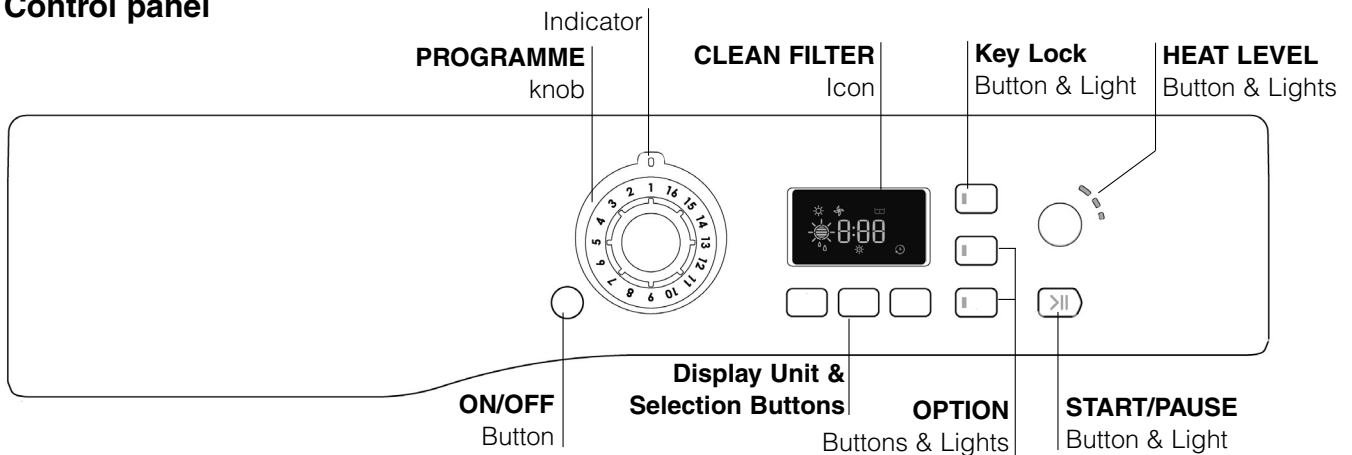

The **ON/OFF** button  : If the dryer is running and this button is pressed and held for more than 3 seconds the dryer is turned off, it counts down 3, 2, 1, Off and the programme is then cancelled. Press and hold for more than 3 seconds and the dryer reactivates.

The **PROGRAMMES** knob sets the programme: rotate it until the indicator is pointing to the programme you want to select (see *Start and Programmes*).

The **OPTION** buttons/lights select available options for your selected programme. The lights indicate that the option has been selected. If an option is not available the buzzer will beep three times (see *Start and Programmes*).

The **START/PAUSE** button/light  starts a selected programme. When you press this button there will be one beep and the progress lights will flash to confirm the action. When a programme is running, pressing this button in pauses the programme and stops the dryer. The light is green when programme is running, flashing amber if the programme has been paused or flashing green if on standby waiting to start a programme (see *Start and Programmes*).

**Note:** This light also flashes amber during the Post Care phase of a programme.

The **Display Unit** gives an indication of the drying or delay time together with icons that light to give warning information and show the status of your programmes progress. The three buttons below the display select 'Automatic' or 'Timed Dry' and if required a delayed start (see *Start and Programmes* or *The Display*).

The **Clean Filter** icon  : gives a reminder before every programme, that it is essential to clean the filter every time the dryer is used (see *Maintenance and Care*).

The **Key Lock** button/light  : Press and hold this button after selecting your programme and any options, the light turns on. This prevents the programme settings from being changed. When the light is lit, the other buttons are disabled. Hold the button to cancel and the light will go out.

# The Display

GB



The Display has three main functions, each with its corresponding button.



## Dryness Sensing Levels



After selecting a programme that has a Sensor Dry option, press and release the button until the required dryness sensing level is displayed. If the sensing option is not available with your selected programme, the display will flash and the buzzer will beep three times.



! Some sensing programmes do not have all five dryness level options available.

Dryness levels:



**Damp Dry:** Dries your items ready to be ironed using a machine or rotary ironer.



**Iron Dry:** Dries your items ready to be ironed with a hand iron.



**Hanger Dry:** Dries your clothes ready to be hanged for final drying.  
Use this programme if you do not need the items to be fully dry as it uses less energy.



**Cupboard Dry:** Dries your items ready to be put away.



**Extra Dry:** Dries your clothes ready to be worn.

## Timed Dry



After selecting a programme that has a Timed Dry option, press the  button and the Timed Dry icon will light, the display will reduce the selected time each time you press and release this button (*see Start and Programmes*). Each programme that has a timed option has different times available and the selection of up to 11 drying times will also depend on the heat setting that you have selected.





Each press of the button decreases the drying time.

If you change your mind, press the Sensor Dry button and the sensing level options are available.

If the Timed Dry option is not available the Timed Dry icon will flash and the buzzer will beep three times. The selected time remains displayed after the programme starts and can be changed during the programme if you wish.

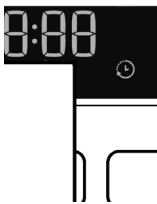
## Delay Timer



After selecting a programme that has a Delay Timer option, a delay start time can be selected. Each press of the Delay Timer button  advances the delay setting in 30 minutes increments from **0:30** to **9:30** and then increments from **10h** to **24h** then **OFF** and then after five seconds cancels the delay.

For delays of 10 hours or more the display counts down the time in hours until 10 hours, then the display shows **9:59** and then continues to count down in minutes.

For delays 9 hours or less the display shows hours and minutes and then counts down in minutes for all of the delay.

After the START/PAUSE button  is pressed the delay time can be changed or cancelled.

When the delay period finishes the delay icon  is off and the **Time to End** is displayed.

## Time to End

If the delay icon  is off the time displayed is the Time to End for the programme running.

When timed programmes are selected the time displayed throughout the cycle is the actual time remaining.

When Automatic programmes are selected the time displayed is an estimate of the time remaining. When the programme is selected the display shows the time required to dry a full load, after around 10 minutes the controller calculates a better estimate of the cycle time and this is updated during the programme.

The Time to End is displayed in hours and minutes and counts down each minute.

The colons between the hours and minutes in the display flash to show the time is counting down.

The display also shows if there is a problem with your dryer, if this occurs the display will show F followed by a fault code number, the three option lights and the START/PAUSE light will also flash amber (*see Troubleshooting*).



# Start and Programmes

## Choosing a programme

1. Plug the dryer into the electrical socket.
2. Sort your laundry according to fabric type (*see Laundry*).
3. Open the door and make sure the filter is clean and in place (*see Maintenance*).
4. Load the machine and make sure items are not in the way of the door seal. Close the door.
5. If none of the lights are on: Press the ON/OFF button .
6. Choose a programme by checking the Programmes Guide (*see Programmes*) as well as the indications for each type of fabric (*see Laundry*).
  - Select a programme by rotating the PROGRAMMES knob.
7. Choose Timed Drying or Dryness Levels option:
  - If Timed Dry press and release the Timed button until the required time is displayed.
  - or - To change from default dryness setting, press and release the Sensor Dry button until the required level is indicated (*see The Display*).
8. Set a delay time and other options if necessary.
9. The START/PAUSE light is flashing green:
  - press the START/PAUSE button to begin. The green light stops flashing.
 During the drying programme, you can check on

- your laundry and take out items that are dry while others continue drying. When you close the door again, press the START/PAUSE button in order to resume drying.
- (When the door is opened the START/PAUSE light will flash Amber, after the door is closed and the START/PAUSE button pressed, the START/PAUSE light will stop flashing and show green.)*
- Note:** During the Post Care phase this light flashes Amber.
10. At the end of the drying cycle the display shows END and either :
    - The buzzer will beep 3 times to let you know that your programme is complete. (**Note:** If the SOUND option was selected the buzzer beeps 3 times every 30 seconds for 5 minutes).
    - or - If you have selected the Crease Care option and you do not take the items out immediately, the items will tumble occasionally for 10 hours or until you open the door, the buzzer will then beep 3 times to confirm the programme is completed.
  11. Open the door, take the laundry out, clean the filter and replace it (*see Maintenance*).
  12. Unplug the dryer.

## ESSENTIALS - Programmes Table

Programme	Options available					Dryness Levels available (default highlighted <input checked="" type="checkbox"/> )				
	Delay Timer	*Crease Care or Sound	Heat Level	Timed Dry	Sensor Dry	Damp Dry	Iron Dry	Hanger Dry	Cupboard Dry	Extra Dry
1 Standard Cotton	✓	✓	- High	✓	✓	✓	✓	✓	<input checked="" type="checkbox"/>	✓
			- Medium - Low	✓	✓	✓	✓	✓	<input checked="" type="checkbox"/>	✗
2 Shirts	✓	✓	- High - Medium	✓	✓	✓	✓	✓	<input checked="" type="checkbox"/>	✗
			- High - Medium	✗	✓	✓	✓	✓	<input checked="" type="checkbox"/>	✗
3 Bed & Bath	✓	✓	- High	✗	✓	✓	✓	✓	<input checked="" type="checkbox"/>	✓
			- Medium	✗	✓	✓	✓	✓	<input checked="" type="checkbox"/>	✗
4 Synthetics	✓	✓	- Medium - Low	✓	✓	✓	✓	✓	<input checked="" type="checkbox"/>	✗
5 Quick Dry Cottons	✓	✓	✗	• An Automatic programme						
6 Quick Dry Synthetics	✓	✓	✗	• An Automatic programme						

\*YOU CANNOT SELECT BOTH CREASE CARE AND SOUND OPTIONS

### Standard Cotton

- This is a programme for cotton items.
- The duration of this programme will depend on the size of the load, the dryness setting selected and the spin speed used in your washer (*see Laundry*).
- The Standard Cotton programme to EU Regulation 392/2012 is Programme 1 selection with High Heat and Dryness Level Cupboard Dry (the standard/default starting configuration). It is the most efficient programme in terms of energy consumption (to EU.392/2012).

### Bed & Bath

- This is a programme for cotton towels and sheets.
- The duration of this programme will depend on the size of the load, the dryness setting selected and the spin speed used in your washer (*see Laundry*).
- Loads dried using the Extra Dry setting are usually ready to use, the edges or seams may be slightly damp especially on large items. If this is the case, try opening them out and running the programme again for a short period.

# Start and Programmes

GB

## Shirts

### High heat option

- This is a programme for shirts made from cotton.
- It can be used for load sizes up to 3kg (approximately 10 shirts).
- The duration of this programme will depend on the size of the load, the dryness setting selected and the spin speed used in your washer.

### Medium heat option

- This is a programme for shirts made from synthetic materials or a mixture of natural and synthetic materials, such as polyester and cotton.
- It can be used for load sizes up to 3kg (approximately 14 shirts).
- The duration of this programme will depend on the size of the load, the dryness setting selected and the spin speed used in your washer.

Loads dried using the Cupboard Dry setting are usually ready to wear, the edges or seams may be slightly damp. If this is the case, try turning the shirts inside out and running the programme again for a short period.

## Synthetics

- This is a programme for items of Synthetic or Synthetic/Cotton mixtures.
- The duration of this programme will depend on the size of the load, the dryness setting selected and the spin speed used in your washer (*see Laundry*).

## Quick Dry Cottons

- This programme is for small loads made from cottons, maximum 1kg.
- Your drying time is very much reduced with a huge time saving up to 53%.

## Quick Dry Synthetics

- This programme is for small loads made from synthetics, maximum 1kg.
- Your drying time is very much reduced with a huge time saving up to 50%.

## ☆ SPECIALS - Programmes Table

Programme	Options available						Dryness Levels available (default highlighted <input checked="" type="checkbox"/> )				
	Delay Timer	*Crease Care or Sound	Sound	Heat Level	Timed Dry	Sensor Dry	Damp Dry	Iron Dry	Hanger Dry	Cupboard Dry	Extra Dry
<b>7</b> Jeans	<input checked="" type="checkbox"/>	<input checked="" type="checkbox"/>	*	X	X	<input checked="" type="checkbox"/>	<input checked="" type="checkbox"/>	<input checked="" type="checkbox"/>	<input checked="" type="checkbox"/>	<input checked="" type="checkbox"/>	<input checked="" type="checkbox"/>
<b>8</b> Wool	X	X	<input checked="" type="checkbox"/>	X	• An Automatic programme						
<b>9</b> Silk	X	X	<input checked="" type="checkbox"/>	X	X	<input checked="" type="checkbox"/>	<input checked="" type="checkbox"/>	<input checked="" type="checkbox"/>	<input checked="" type="checkbox"/>	<input checked="" type="checkbox"/>	X
<b>10</b> Delicates (eg. Acrylics)	<input checked="" type="checkbox"/>	<input checked="" type="checkbox"/>	*	X	<input checked="" type="checkbox"/>	<input checked="" type="checkbox"/>	<input checked="" type="checkbox"/>	<input checked="" type="checkbox"/>	<input checked="" type="checkbox"/>	<input checked="" type="checkbox"/>	X
<b>11</b> Lingerie	<input checked="" type="checkbox"/>	<input checked="" type="checkbox"/>	*	X	X	<input checked="" type="checkbox"/>	<input checked="" type="checkbox"/>	<input checked="" type="checkbox"/>	<input checked="" type="checkbox"/>	<input checked="" type="checkbox"/>	X
<b>12</b> Baby	<input checked="" type="checkbox"/>	<input checked="" type="checkbox"/>	*	X	X	<input checked="" type="checkbox"/>	<input checked="" type="checkbox"/>	<input checked="" type="checkbox"/>	<input checked="" type="checkbox"/>	<input checked="" type="checkbox"/>	X

\*YOU CANNOT SELECT BOTH CREASE CARE AND SOUND OPTIONS

## Jeans

- This is a programme for jeans made from denim cotton. Before drying your jeans turn the front pockets inside out.
- It can be used for load sizes up to 3kg (approximately 4 pairs).
- Do not mix dark and light coloured items.
- It can also be used on other garments made from the same material, such as jackets.
- The duration of this programme will depend on the size of the load, the dryness setting selected and the spin speed used in your washer.
- Loads dried using the Extra Dry setting are usually ready to wear, the edges or seams may be slightly damp. If this is the case, try turning the jeans inside out and running the programme again for a short period.

! We do not recommend that you use this programme if your jeans have elastic waist bands, studs or embroidery.

## Wool Programme

- This is a programme for tumble dryer safe garments marked with the symbol  .
  - It can be used for load sizes up to 1kg (approximately 3 sweaters).
  - We recommend that garments are turned inside out before drying.
  - This programme will take about 60 minutes, but may take longer depending on the size and density of the load and the spin speed used in your washer.
  - Loads dried using this programme are usually ready to wear, but on some heavier garments the edges may be slightly damp. Allow these to dry naturally as over-drying could damage garments.
- ! Unlike other materials, the mechanism of wool shrinkage is irreversible; i.e. it will not stretch back to original size and shape.
- ! This programme is not suitable for Acrylic garments.

---

## Silk

- This is a programme for drying your delicate silk.
- It can be used for load sizes up to 0.5kg.
- The duration of this programme will depend on the size of the load, the dryness setting selected and the spin speed used in your washer.
- Loads dried using the Cupboard Dry setting are usually ready to use, but on some garments the edges may be slightly damp. If this is the case, try opening them out or turn items inside out and running the programme again for a short period.

---

## Delicates

- This is a programme for drying your delicate clothes ie. Acrylics.
- It can be used for load sizes up to 2kg.
- The duration of this programme will depend on the size of the load, the dryness setting selected and the spin speed used in your washer.
- Loads dried using the Cupboard Dry setting are usually ready to use, but on some garments the edges may be slightly damp. If this is the case, try opening them out or turn items inside out and running the programme again for a short period.

---

## Lingerie

- This is a programme for drying your very delicate lingerie, including silk.
- It can be used for load sizes up to 1kg, close all hooks, buttons or zips before drying.
- The duration of this programme will depend on the size of the load, the dryness setting selected and the spin speed used in your washer.
- Loads dried using the Cupboard Dry setting are usually ready to use, but on some garments the edges may be slightly damp. If this is the case, try opening them out or turn items inside out and running the programme again for a short period.

---











## Baby Programme

- This is a programme for drying your baby's small delicate items of clothing and bedding (Cotton and Chenille) and for drying your delicate clothes.
- DO NOT dry items such as bibs and nappy pants with plastic coverings.
- It can be used for load sizes up to 2kg.
- The duration of this programme will depend on the size of the load, the dryness setting selected and the spin speed used in your washer.
- Loads dried using the Cupboard Dry setting are usually ready to use, but on some garments the edges may be slightly damp. If this is the case, try opening them out or turn items inside out and running the programme again for a short period.

# Start and Programmes

GB

## READY TO WEAR - Programmes Table

Programme	Options available					Dryness Levels available					
	 Delay Timer	 *Crease Care or  Sound	 Sound	Heat Level	 Timed Dry	 Sensor Dry	 Damp Dry	 Iron Dry	 Hanger Dry	 Cupboard Dry	 Extra Dry
<b>13 Dry from Damp</b>	✓	✓	*	- High - Medium	• An Automatic programme						
<b>14 Business Week</b>	✓	✓	*	- High - Medium	• An Automatic programme						
<b>15 Linen Change</b>	✓	✓	*	- High - Medium	• An Automatic programme						
<b>16 Revitalise</b>	✗	✗	✓	✗	• An Automatic programme						

\*YOU CANNOT SELECT BOTH CREASE CARE AND SOUND OPTIONS

### Dry from Damp

This programme is for drying damp items that you have used just once.

It avoids hanging damp items, adding humidity in a room. This is particularly applicable to a bathroom, where damp towels or bathrobes can have a noticeable affect.

This programme has a duration of 15 minutes, it can be used on a bathrobe or 2 towels (1 large bath towel and 1 small hand towel).

**Note:** It is a fire hazard to dry any items that may have been subjected to contamination by chemical products without first washing the items with detergent and water (*see Warnings*).

### Business Week

This is a quick timed programme, ideal for drying garments spun at high speed in the washing machine, for example shirts used in a working week.

- The programme duration is 40 minutes.

### Linen Change

This is a timed programme, ideal for drying garments spun at high speed in the washing machine, for example a change of sheets.

- The programme duration is 60 minutes.

### Revitalise

**!** 'Revitalise' is **not a drying programme** and should not be used for wet articles of clothing.

- It can be used on any load size but is more effective on smaller loads.
- Do not overload your dryer (*see Laundry*).
- This is a 20 minute programme that airs your clothes with cool air. Also use to cool warm clothes.

## The Controls

### • Programmes knob

**! Warning**, if after pressing the START/PAUSE button >|| the programme knob position has changed, the new position will **NOT** change the programme selected.

To change a selected programme, press the START/PAUSE button >||, the light flashes Amber to indicate the programme is paused. Select the new programme and any options required, the light will then flash green. Press the START/PAUSE button >|| again and the new programme will start.

### • OPTION buttons / lights

These buttons are used to customise the selected programme to your requirements. A programme must have been selected on the programme knob before an option can be selected. Not all options are available for all programmes (*see Start and Programmes*). If an option is not available and you press the button, the buzzer will beep three times. If the option is available the option light in the button lights to confirm the selection.

After the START/PAUSE button has been pressed only the Crease Care or Sound options (where available) can be changed.

#### Progress ( Drying, Cool Tumble) icons

These are part of the Display, they indicate the progress of the dryer. Each icon comes on as the corresponding phase starts.

#### Time Delay (Delay Timer)

The start of some programmes (*see Start and Programmes and The Display*) can be delayed for up to 24 hours.

#### Crease Care

The *pre-care option* is only available if a delayed start has been selected. It tumbles the clothes occasionally during the delayed period to help prevent creases developing.

The *post-care option* occasionally tumbles the clothes after the end of the drying and cool tumble cycles to prevent creases developing, should you not be available to remove the load immediately the programme is complete. The display will show 'End'. **Note:** The Crease Care and the Start/Pause lights flash Amber during this phase.

Selecting this option enables both the pre and post care functions if appropriate and when selected the light in the button is lit.

**Note:** If you have selected the Sound option this option is not available.

#### Heat Level buttons and lights

Not all programmes allow you to change the heat level and some programmes allow all three heat level options: Low, Medium and High.

When the heat level options are available pressing this button changes the heat level and the light corresponding to the selection is lit.

## Sound

If selected, gives a signal at the end of the drying cycle, to remind you that the clothes are ready to be removed.

**Note:** If you have selected the Crease Care option this option is not available.

### • DISPLAY

The display shows either the amount of time delay remaining or an indication of the amount of time left for a drying programme (*see The Display*).

The colons between the hours and minutes in the display flash to show that the time is counting down.

When the programme finishes its cool tumble phase the display will show 'End'.

### • Door Opening

Opening the door (or pressing the Start/Pause button) during a programme will stop the dryer and have the following effects:

**Note:** The Start/Pause light flashes Amber during the Post Care phase of a programme.

- The START/PAUSE light flashes Amber.
- The START/PAUSE button **must** be pressed to resume the programme, including a delayed start. The progress lights will change to show the current status and the START/PAUSE light will stop flashing and turn green.
- During a delay phase the delay will continue to count down.
- During the post-care phase of a drying programme, the programme will finish. Pressing the START/PAUSE button will re-start a new programme at the beginning.
- Changing the programmes knob will select a new programme and the START/PAUSE light will flash green. You can use this to select the Revitalise programme to cool the clothes, if you find them dry enough. Press the START/PAUSE button to begin a new programme.

### • Note

If you have a power cut, switch off the power or remove the plug. When power is restored, press and hold the ON/OFF button until the dryer reactivates, then press the Start/Pause button.

# Laundry

GB

## Sorting your laundry

- Check symbols on clothing labels to make sure that the articles can be tumble dried.
- Sort laundry by fabric type.
- Empty pockets and check buttons.
- Close zippers and hooks and tie loose belts and strings.
- Wring out each item in order to eliminate as much excess water as possible.

! Do not load dripping wet clothes into the dryer.

## Maximum load size

Do not load more than maximum capacity.

These numbers refer to dry weight:





Natural fibres: 7kg max (15lb)

Synthetic fibres: 4kg max (9lb)

! DO NOT overload the dryer as this could result in reduced drying performance.

## Wash Care Labels

Look at the labels on your garments, especially when tumble drying for the first time. The following symbols are the most common:

-  May be tumble dried
-  Do **not** tumble dry
-  Tumble dry at high heat setting
-  Tumble dry at low heat setting

## Drying times

The table (*see below*) presents APPROXIMATE drying times in Minutes. Weights refer to dry garments.

Times are approximate and can vary depending upon:

- Amount of water retained in clothes after spin cycle: towels and delicates retain a lot of water.
- Fabrics: items that are the same type of fabric but different textures and thicknesses may not have the same drying time.
- Quantity of laundry: single items or small loads may take longer to dry.
- Dryness: If you are going to iron some of your clothes, they can be taken out while still a bit damp. Others can be left longer if you need them to be completely dry.
- Heat setting.
- Room temperature: if the room where the dryer is located is cold, it will take longer for the dryer to dry your clothes.
- Bulk: some bulky items can be tumble dried with care. We suggest that you remove these items several times, shake them out, and return them to the dryer until finished.

! Do not over-dry your clothes.

All fabrics contain a little natural moisture, which keeps them soft and fluffy.

<b>Cottons</b> (use Full Heat for Timed Drying) - spin speed 800-1000 rpm in washing machine.							
Load size	1 kg	2 kg	3 kg	4 kg	5 kg	6 kg	7 kg
Drying times, in minutes	20 - 30	35 - 45	45 - 60	60 - 70	70 - 80	80 - 100	90 - 120
<b>Synthetics</b> (use Full Heat for Timed Drying) - on reduced spin in washing machine.							
Load size	1 kg	2 kg	3 kg	4 kg			
Drying times, in minutes	20 - 40	30 - 50	40 - 70	55 - 90			
<b>Delicates e.g. Acrylics</b> (use Timed Drying with Low Heat) - on reduced spin in washing machine.							
Load size	1 kg			2 kg			
Drying times, in minutes	30			60			

- **Note:** At the end of a drying cycle, cottons could still be damp if you grouped cottons and synthetics together. If this is the case, simply give the damp cotton items an additional short period of drying.

One day your dryer seems not to be working. Before you call your Service Centre (*see Service*), go through the following troubleshooting suggestions:

## Problem:

## Possible causes / Solution:

### The tumble dryer won't start.

- The plug is not plugged into the socket, or not making contact.
- There has been a power failure.
- The fuse has blown. Try to plug another appliance into the socket.
- You are using an extension cord? Try to plug the dryer's power cord directly into the socket.
- The door is not closed securely?
- The PROGRAMMES knob has not been set properly (*see Start and Programmes*).
- The START/PAUSE button has not been pressed (*see Start and Programmes*).

### Drying cycle will not begin.

- You have set a delayed time (*see Start and Programmes*).

### Its taking a long time to dry.

- The filter has not been cleaned (*see Maintenance*).
- The correct programme has not been selected for the type of fabric you are drying (*see Start and Programmes*).
- The flexible vent tube is obstructed (*see Installation*).
- The air intake vent is obstructed (*see Installation*).
- The permanent ventilation flap on the storm cover is obstructed (*see Installation*).
- The items were too wet (*see Laundry*).
- The dryer was overloaded (*see Laundry*).

### Programme finishes and clothes are damper than expected.

! For safety the dryer has a maximum programme time of 5 hours. If an automatic programme has not sensed the required final moisture in this time the dryer will complete the programme and stop. Check the above points and run the programme again, if the results are still damp, contact the Service Centre (*see Service*).

### The option lights flash and the display shows a fault code F followed by one or two numbers.

- If the display shows a fault:
  - Turn off and remove the plug. Clean the filter (*see Maintenance*). Then replace the plug, turn on and start another programme. If a fault is then displayed: Note down the code and contact the Service Centre (*see Service*).

### The display briefly shows every 6 seconds.

- The dryer is in 'Demo' mode. Press and hold both the On/Off and Start/Pause buttons for 3 seconds. The display will show  for 3 seconds and then the dryer will resume normal operation.

**Note:** This tumble dryer, in compliance with new energy saving regulations, is fitted with an automatic standby system which is enabled after about 30 minutes if no activity is detected. Press and hold the ON/OFF button until the dryer reactivates.

# Service

GB

## Before calling the Service Centre:

- Use the troubleshooting guide to see if you can solve the problem yourself (*see Troubleshooting*).
- If not, turn off the dryer and call the Service Centre closest to you.

## Spare Parts

This dryer is a complex machine. Repairing it yourself or having a non-authorised person try to repair it could cause harm to one or more persons, could damage the machine and could invalidate the spare parts warranty.

Call an authorised technician if you experience problems while using the machine.

## Essential Contact Information

### Hotpoint Service - Service You Can Rely On

At Hotpoint we pride ourselves on offering our customers the best service we possibly can, wherever you are in the UK and Ireland.

Rest assured though, no one knows a Hotpoint appliance better than we do and our service is second to none...

**Wherever you are we can be there** - we have over 1,000 highly skilled Hotpoint engineers covering the whole of the UK and Ireland ensuring fast, reliable, local service.

**'Right first time'** - our engineers have the latest tools to help get your Hotpoint appliance back up and running the first time we visit.

**Experts in our field** - all of our engineers are trained to the highest standard at our Hotpoint Training Centre of Excellence with unrivalled expertise and product knowledge.

**Skilled staff** - we have over 400 skilled UK based call centre staff, dedicated to offering you excellent service 364 days a year.

Telephone in the United Kingdom: 03448 224 224

Telephone in the Republic of Ireland: 0818 313 413

[www.hotpointservice.co.uk](http://www.hotpointservice.co.uk)

### Our advisors will require the following information:

- name, address and post code.
- telephone number.
- the type of problem.
- the date of purchase.

- the appliance model (Mod.).
- the serial number (S/N).

This information can be found on the data label inside the door of the machine.

## Save energy and respect the environment

- Wring out items to eliminate excess water before tumble drying (if you use a washing machine first, select a high spin cycle). Doing this will save time and energy during drying.
- Always dry full loads - you save energy: single items or small loads take longer to dry.
- Clean the filter after each use to contain energy consumption costs (*see Maintenance*).

## Recycling and Disposal Information



As part of our continued commitment to helping the environment, we reserve the right to use quality recycled components to keep down customer costs and minimise material wastage.

- Disposing of the packaging material: follow local regulations, so the packaging can be recycled.
- To minimise risk of injury to children, remove the door and plug - then cut off mains cable, flush with the appliance. Dispose of these parts separately to ensure that the appliance can no longer be plugged into a mains socket.

### Disposal of old electrical appliances

The European Directive 2012/19/EC on Waste Electrical and Electronic Equipment (WEEE), requires that old household electrical appliances must not be disposed of in the normal unsorted municipal waste stream. Old appliances must be collected separately in order to optimise the recovery and recycling of the materials they contain and reduce the impact on human health and the environment.



The crossed out "wheeled bin" symbol on the product reminds you of your obligation, that when you dispose of the appliance it must be separately collected.

Consumers should contact their local authority or retailer for information concerning the correct disposal of their old appliance.



Brand <b>Hotpoint</b>	Models <b>TVF ET 75B</b> <b>TVF XT 75B</b> <b>FVFET 75B</b>
Rated capacity of Cotton laundry for the standard programme at full load <b>7 kg</b>	Energy efficiency class <b>B</b>
The weighted Annual Energy Consumption ( $AE_c$ ) <b>471.8 kWh</b> Consumption per year, based on 160 drying cycles of the standard cotton programme at full and partial load, and the consumption of the low-power modes. Actual energy consumption per cycle will depend on how the appliance is used.	
This household tumble dryer is an <b>Automatic Air-Vented Dryer</b>	
Energy consumption : full load $E_{dry}$ <b>4.04 kWh</b> , partial load $E_{dry1/2}$ <b>2.12 kWh</b>	
Power consumption : off-mode ( $P_o$ ) <b>0.14 W</b> , left-on mode ( $P_l$ ) <b>2.69 W</b>	
Duration of the 'left-on mode' for power management systems <b>30</b> minutes	
The 'standard cotton programme' suitable for drying normal wet cotton laundry that is the most efficient programme in terms of energy consumption for cotton used at full and partial load is <b>Standard Cotton, High Heat, Cupboard Dry</b>	
Programme time (minutes) : weighted ( $T_t$ ) full & partial load <b>84</b> , full load ( $T_{dry}$ ) <b>115</b> , partial load ( $T_{dry1/2}$ ) <b>60</b>	
Airborne acoustical noise emissions <b>69 dB(A) re 1 pW</b>	

\* "consumer information in compliance with EU Regulation 932/2012".

Typical energy used	- Synthetics	full load <b>1.63 kWh</b> ,	partial load <b>not applicable</b>
Typical drying time	- Synthetics	full load <b>55</b> minutes,	partial load <b>not applicable</b>

**CE** This appliance conforms to the following EC Directives:  
 - 2006/95/EC (Low Voltage Equipment)  
 - 2004/108/EC (Electromagnetic Compatibility)







195130371.00 N

01/2015 - LION fpg - Four Ashes, Wolverhampton

GB