

**#54112, #54113, #54123,
#54129, #54148**

220-240V~50Hz

2,050W at 20°C, IPX5

Bestway

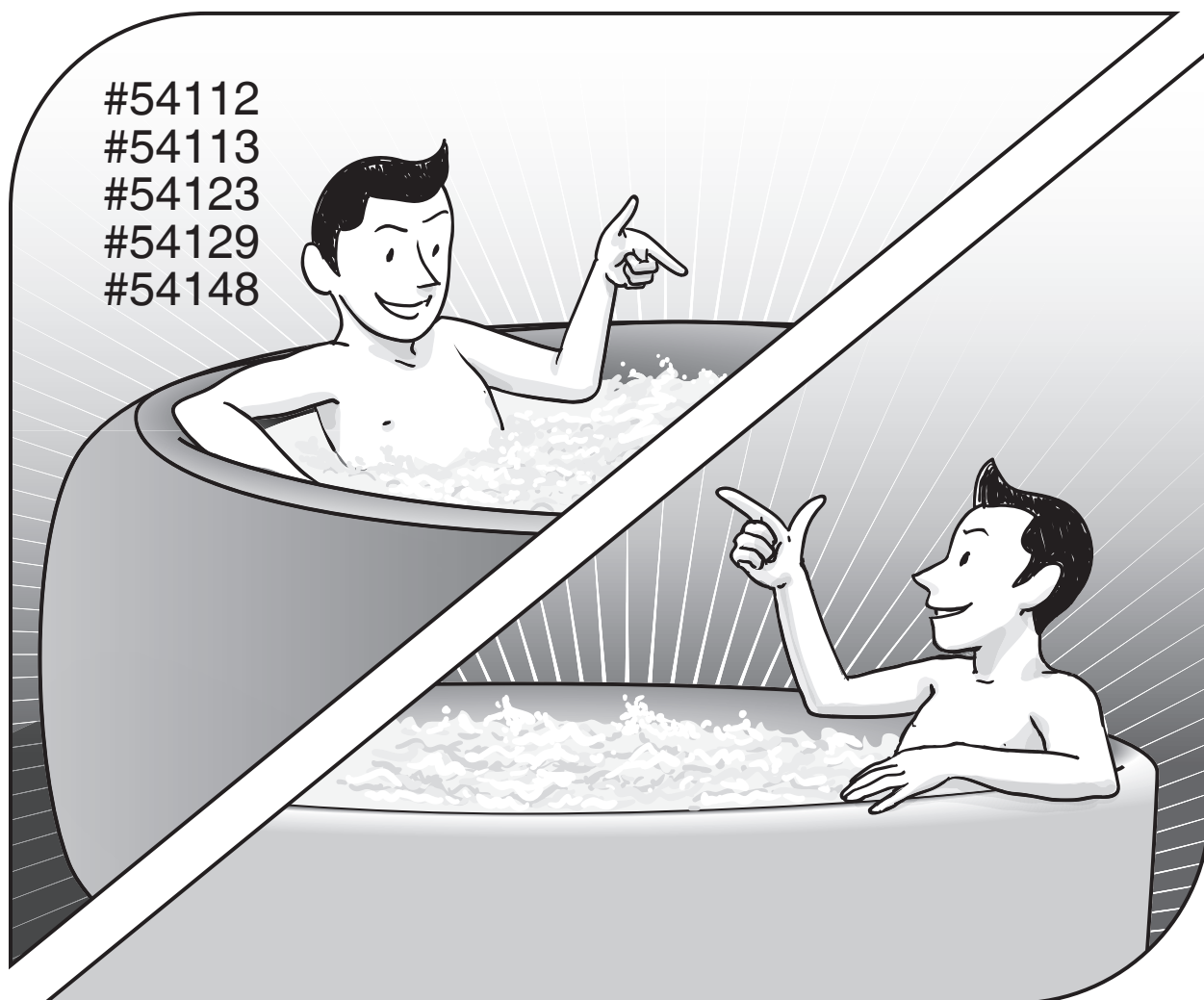

Lay-Z-Spa™

www.bestway-global.com
www.bestway-service.com



Lay-Z-Spa™

Owner's Manual

ENGLISH	P3
PORTUGUÊS	P23
ESPAÑOL	P43
DEUTSCH	P63
SUOMI	P83
NEDERLANDS	P103
ITALIANO	P123
FRANÇAIS	P143
ΕΛΛΗΝΙΚΑ	P163
РУССКИЙ	P183
POLSKI	P203
MAGYAR	P223
SVENSKT	P243

CONTENTS

1. Safety Instructions	P3	5. Maintenance	P19
2. Specifications	P6	Filter Cartridge Maintenance	
3. Installation	P11	Water Maintenance	
Selected Location		Air-Valve Adjustment	
Pump Test		Draining the Spa	
Assembly		Cleaning the spa	
4. Pump Operation	P17	Spa Repair	
Heating Reset		Lay-Z-Spa Storage	
Control Panel		Disposal	
Alarms		6. Troubleshooting	P21
		7. Warranty	P22



SAFETY INSTRUCTIONS WARNING

When installing and using this electrical equipment, basic safety precaution should always be followed, including the following:

IMPORTANT SAFETY INSTRUCTIONS - READ AND FOLLOW ALL INSTRUCTIONS.

WARNING:

- The spa must be supplied through an isolating transformer or supplied through a residual current device (RCD) having a rated residual operating current not exceeding 30mA.
- The pump must be tested before each use, to test follow the instruction of pump.
- If the supply cord is damaged, it must be replaced by the manufacturer, service agent or similarly qualified persons in order to avoid a hazard.
- To reduce the risk of electric shock, do not use extension cord to connect unit to electric supply; provide a properly located outlet.
- No part of the appliance is to be located above the bath during use.
- Parts containing live parts, except parts supplied with safety extra-low voltage not exceeding 12V, must be inaccessible to a person in spa pool; Parts incorporating electrical components, except remote control devices, must be located or fixed so that they cannot fall into the spa pool.
- The plug of pump shall be more than 3.5m away from the spa.
- It is necessary to have the plug accessible after installation of the spa.
- **TO AVOID ELECTRIC SHOCK, DO NOT USE THE SPA WHEN IT IS RAINING.**
- Never wear your contact lenses when in your spa.
- Do not use spa during chemical maintenance.
- The power source on the wall of building should keep more than 4m away from pool and at a height of 1.2m at least.
- Extension cords can't be used.
- Don't plug or unplug the appliance if hand is wet.
- Always unplug the appliance:
 - on rainy days
 - before cleaning or other maintenance
 - if leave it unattended on holidays
- Cleaning and user maintenance must be performed by an adult above 18 years old who is familiar with the risk of electric shock.
- When the appliance will be not used for a long time, such as in the winter, the spa or pool set should be disassembled and stored indoor.
- **Caution:** Read the instruction before using the appliance and installation or reassemble every time.
- Safekeeping the instruction. If instruction is missed, please contact with manufacturer or search it in website www.bestway-service.com
- **Warning: For electric safety, a leakage current detecting device is incorporated in the**

product, if the leakage current is detected more than 10mA, the device will operate and cut-off the power supply, in such case, please unplug and stop using the spa at once. Don't reset the product by yourself. And you must contact the local service agent to check and repair the product.

- This appliance can be used by children aged from 8 years and above and persons with reduced physical, sensory or mental capabilities or lack of experience and knowledge if they have been given supervision or instruction concerning use of the appliance in a safe way and understand the hazards involved. Children shall not play with the appliance. Cleaning and user maintenance shall not be made by children without supervision. (For EU market)
- **WARNING** - This appliance is not intended for use by persons (including children) with reduced physical, sensory or mental capabilities, or lack of experience and knowledge, unless they have been given supervision or instruction concerning use of the appliance by a person responsible for their safety. Children should be supervised to ensure that they do not play with the appliance. (For market other than EU)
- Water attracts children; always attach a spa cover after each use.
- Do not bury cord. Locate cord to minimize abuse from lawn mowers, hedge trimmers, and other equipment.
- Risk of Accidental Drowning. Extreme caution must be exercised to prevent unauthorized access by children. To avoid accidents, ensure that children can not use this spa unless they are supervised at all times.
- **RISK OF INJURY.** Never operate spa if inlet / outlet pipes are broken or missing. Never attempt to replace the inlet / outlet pipes. Always consult your local Aftersales centre.
- **RISK OF ELECTRIC SHOCK.** Install at least 2m from all metal surfaces.
- **RISK OF ELECTRIC SHOCK.** Never operate any electrical appliance when in your spa or when your body is wet. Never place any electric appliance, such as a light, telephone, radio, or television, within 2m of spa.
- During pregnancy, soaking in hot water may cause damage to the fetus. Limit use to 10 minutes at a time.
- **TO REDUCE THE RISK OF INJURY:**
 - A. The water in a spa should never exceed 40°C (104°F). Water temperature between 38°C (100°F) and 40°C (104°F) is considered safe for a healthy adult. Lower water temperatures are recommended for young children and when spa use exceeds 10 minutes.
 - B. Since excessive water temperatures have a high potential for causing fetal damage during the early months of pregnancy, pregnant or possibly pregnant women should limit spa water temperature to 38°C (100°F).
 - C. Before entering a spa, the user should measure the water temperature with an accurate thermometer since the tolerance of water temperature regulating device varies.
 - D. The use of alcohol, drugs, or medication before or during spa use may lead to unconsciousness with the possibility of drowning.
 - E. Obese persons and persons with a history of heart disease, low or high blood pressure, circulatory system problems, or diabetes should consult a physician before using a spa.
 - F. Persons using medication should consult a physician before using a spa since some medication may induce drowsiness while other medication may affect heart rate, blood pressure, and circulation.
- **TO REDUCE THE RISK OF INJURY:** Never pour water with a temperature higher than 40°C (104°F) into the spa pool directly.
- The use of alcohol, drugs, or medication can greatly increase the risk of fatal hyperthermia. Hyperthermia occurs when the internal temperature of the body reaches a level that is several degrees above the normal body temperature of 37°C (98.6°F). The symptoms of hyperthermia include an increase in the internal temperature of the body, dizziness, lethargy, drowsiness, and fainting. The effects of hyperthermia include failure to perceive heat; failure to recognize the need to exit spa or hot tub; unawareness of impending hazard; fetal damage in pregnant women; physical inability to exit the spa or hot tub; and unconsciousness resulting in the danger of drowning.
- Electric installations should follow national wiring rules, consult a qualified electrician with any questions.

CONSULT YOUR PHYSICIAN FOR RECOMMENDATIONS. CAUTION:

- The spa should not be setup or left out in temperature lower than 4°C (40°F).
- Do not use the spa alone.
- People with infectious diseases should not use a spa.
- Do not use the spa immediately following strenuous exercise.
- Always enter and exit the spa slowly and cautiously. Wet surfaces are slippery.
- To avoid damage to the pump, the spa must never be operated unless the spa is filled with water.
- Immediately leave spa if the user feels uncomfortable or sleepy.
- Never add water to chemicals. Always add chemicals to water to avoid strong fumes or violent reactions that may result in hazardous chemical spray.
- Regarding the information pertaining to cleaning, maintenance of water, and disposal of water, please see section "MAINTENANCE".
- Regarding the information pertaining to the installation, thanks to refer to the below paragraph of the manual.

NOTE:

- Please examine equipment before use. Notify Bestway at the customer service address listed on this manual for any damaged or missing parts at the time of purchase. Verify that the equipment components represent the models that you had intended to purchase.
- This product is not intended for commercial use.

SAVE THESE INSTRUCTIONS

IMPORTANT!

To reach 40°C (104°F), the heating duration required is base on the starting water temperature and ambient temperature, the data below is purely for reference. To display the current water temperature, run the filter system for at least a minute.

Ambient Temperature	Water Temperature	Set Temperature	Heating Duration
10°C(50°F)	10°C(50°F)	40°C(104°F)	18.5h
15°C(59°F)	15°C(59°F)	40°C(104°F)	15h
20°C(68°F)	20°C(68°F)	40°C(104°F)	11.5h
25°C(77°F)	25°C(77°F)	40°C(104°F)	8.5h
30°C(86°F)	30°C(86°F)	40°C(104°F)	5.5h

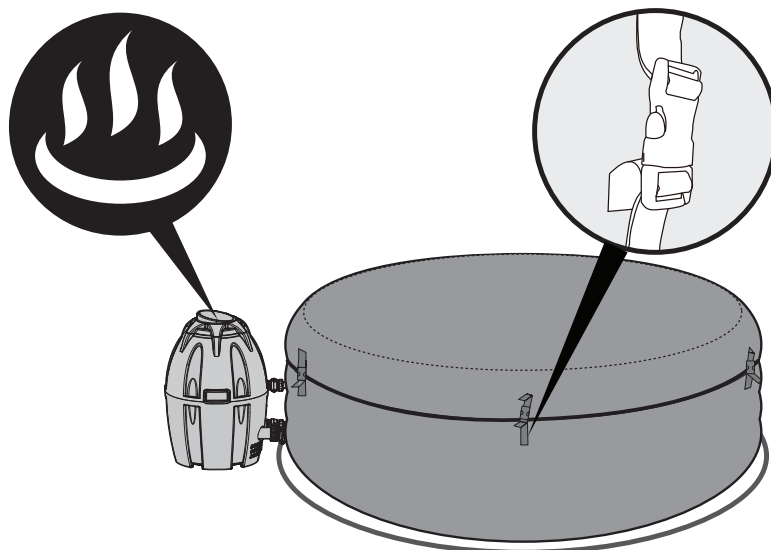

Be sure to cover the SPA with the SPA cover whenever the heating function is activated. Leaving the SPA uncovered will increase the heating duration required. Please do not use the SPA when ambient temperature is lower than 4°C (39°F).

SPECIFICATIONS FOR LAY-Z-SPA™ VEGAS (#54112)

Capacity:	4-6 Adults	Massaging Turbo Blower:	800W	Increased Heat Rate:	Approximately 1.5-2°C/h (3-4°F/h)
Water Capacity (80%):	848 L (224 gal)	Heat Element:	2,000W at 20°C	Actual Water Flow:	1,325 L/h (350 gal/h)
Inflated Size:	1.96m x 61cm (77" x 24")	Pump:	50W Circulation Filter Pump	Power Rate:	220-240V AC, 2,050W at 20°C
Filled Weight:	1,100 kg (2,426 Lb)	Temperature Capacities:	40°C (104°F)	Working Pressure:	0.8PSI (0.055Bar)

NOTE: The above heating rate is based on a lab test conducted with an ambient temperature of 25°C (77°F) and above.

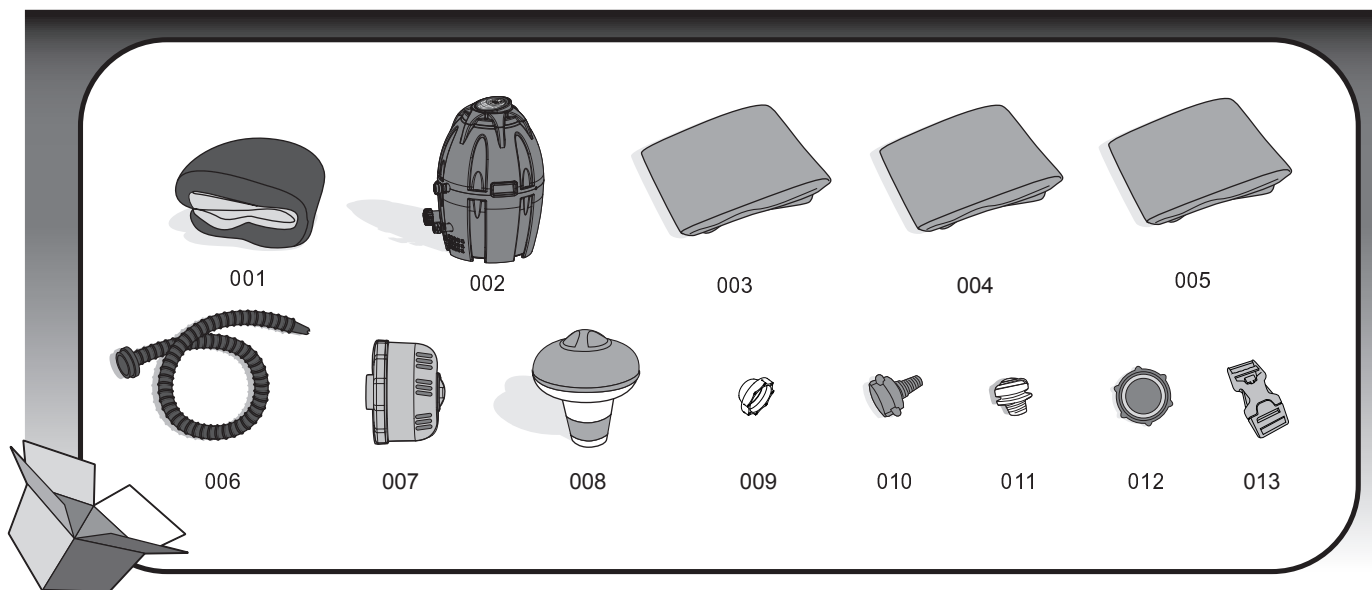

Part N.	Part Code	Description	QTY
001	54112TASS15	Pool liner	1
002	P4H054ASS16	SPA Heater	1
003	P5H284GASS16	Top Leatheroid Cover	1
004	P5H284TASS16	Liner Leatheroid Cover	1
005	54112GASS15	Inflatable Cover	1
006	P6613	Inflation Hose	1
007	P6653	Filter Set	1
008	58210SA10	Chemical Floater	1
009	P6575	Stoppers	2
010	P6932	Hose Adapter	1
011	F4A024ASS	Screw Valve	1
012	P6611	Cover Adapter A	1
013	F6414ASS	Buckle	8

SPECIFICATIONS FOR LAY-Z-SPA™ MONACO (#54113)

Capacity:	6-8 Adults	Massaging Turbo Blower:	800W	Increased Heat Rate:	Approximately 1.0-1.5°C/h (2-3°F/h)
Water Capacity (80%):	1,540 L (407 gal.)	Heat Element:	2,000W at 20°C	Actual Water Flow:	1,325 L/h (350 gal/h)
Inflated Size:	2.01m x 69cm (79" x 27")	Pump:	50W Circulation Filter Pump	Power Rate:	220-240V AC, 2,050W at 20°C
Filled Weight:	1,973 kg (4,349 Lb)	Temperature Capacities:	40°C (104°F)	Working Pressure:	7PSI-10PSI (0.48Bar-0.69Bar)

NOTE: The above heating rate is based on a lab test conducted with an ambient temperature of 25°C (77°F) and above.

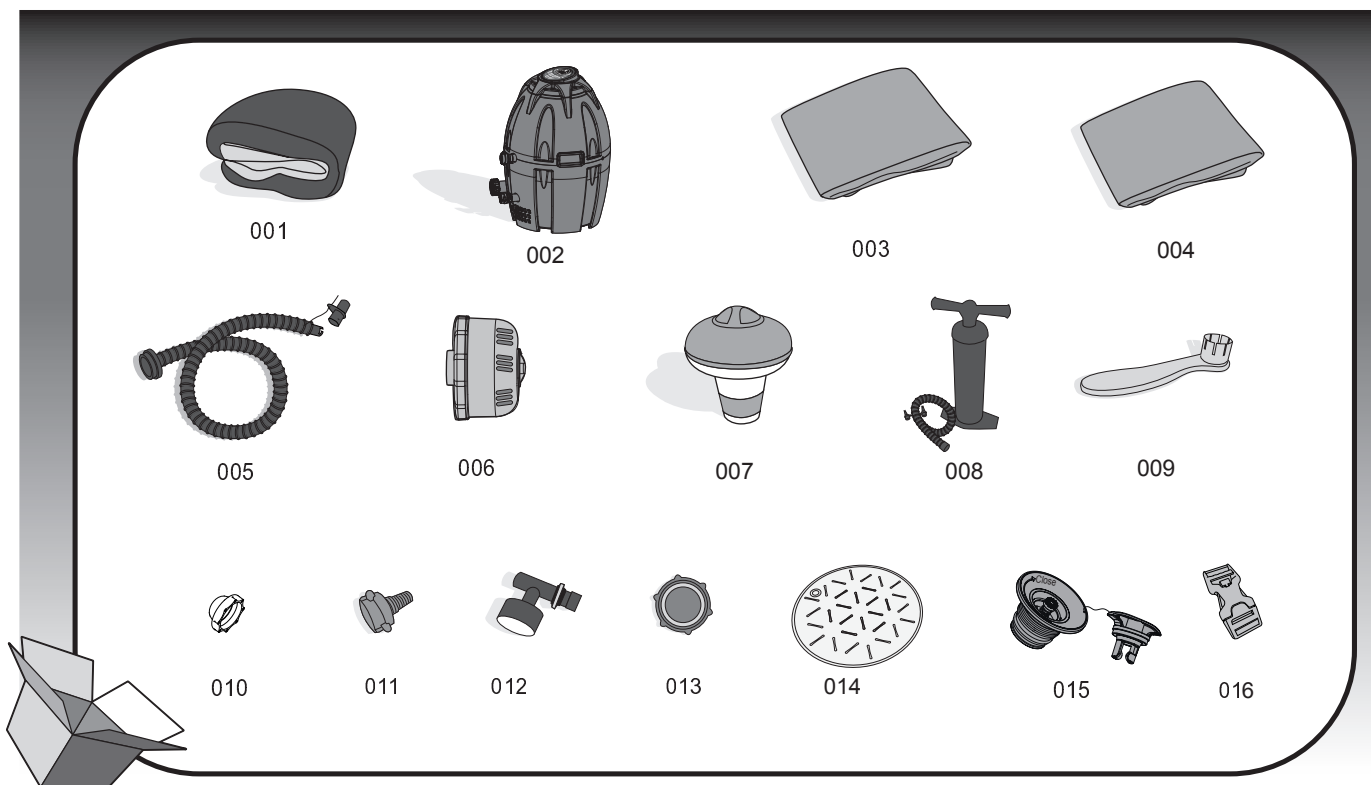

Part N.	Part Code	Description	QTY
001	54113TASS16	Pool liner	1
002	P4D055ASS16	SPA Heater	1
003	P5D288ASS16	Top Leatheroid Cover	1
004	54113GASS15	Inflatable Cover	1
005	P6931	Inflation Hose	1
006	P6653	Filter Set	1
007	58210SA10	Chemical Floater	1
008	P3039Q15	High Pressure Hand Pump	1
009	F6H189ASS15	Wrench	1
010	P6575	Stoppers	2
011	P6932	Hose Adapter	1
012	P6608	Pressure Gauge	1
013	P6611	Cover Adapter A	1
014	12632ASS15	Inflated Cushions	4
015	P6H971	Inflation Valve	1
016	F6414ASS	Buckle	6

SPECIFICATIONS FOR LAY-Z-SPA™ MIAMI (#54123)

Capacity:	2-4 Adults	Massaging Turbo Blower:	800W	Increased Heat Rate:	Approximately 1.5-2°C/h (3-4°F/h)
Water Capacity (80%):	800 L (211 gal)	Heat Element:	2,000W at 20°C	Actual Water Flow:	1,325 L/h (350 gal/h)
Inflated Size:	1.80m x 66cm (71" x 26")	Pump:	50W Circulation Filter Pump	Power Rate:	220-240V AC, 2,050W at 20°C
Filled Weight:	1,026 kg (2,261 Lb)	Temperature Capacities:	40°C (104°F)	Working Pressure:	0.8PSI (0.055Bar)

NOTE: The above heating rate is based on a lab test conducted with an ambient temperature of 25°C (77°F) and above.

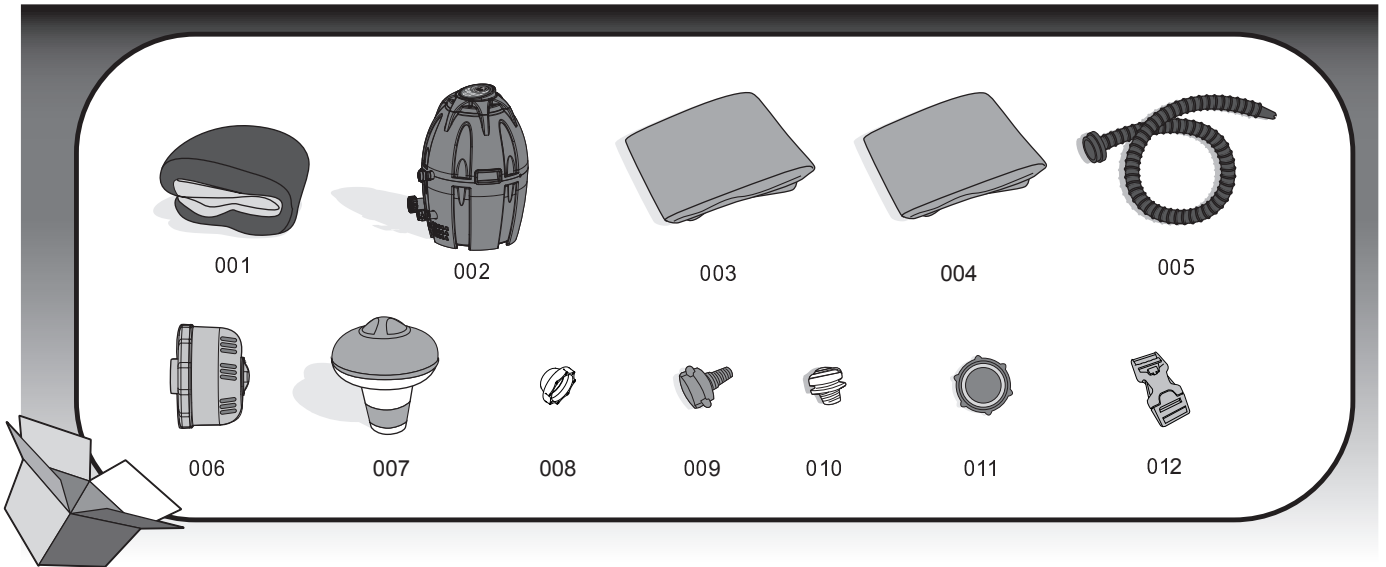

Part N.	Part Code	Description	QTY
001	54123TASS16	Pool liner	1
002	P4H054ASS16	SPA Heater	1
003	P5C364ASS16	Top Reinforce Cover	1
004	54123GASS15	Inflatable Cover	1
005	P6613	Inflation Hose	1
006	P6653	Filter Set	1
007	58210SA10	Chemical Floater	1
008	P6575	Stoppers	2
009	P6932	Hose Adapter	1
010	F4024ASS	Screw Valve	1
011	P6611	Cover Adapter A	1
012	F6414ASS	Buckle	6

SPECIFICATIONS FOR LAY-Z-SPA™ PALM SPRINGS (#54129)

Capacity:	4-6 Adults	Massaging Turbo Blower:	800W	Increased Heat Rate:	Approximately 1.5-2°C/h (3-4°F/h)
Water Capacity (80%):	963 L (254 gal.)	Heat Element:	2,000W at 20°C	Actual Water Flow:	1,325 L/h (350 gal/h)
Inflated Size:	1.96m x 71cm (77" x 28")	Pump:	50W Circulation Filter Pump	Power Rate:	220-240V AC, 2,050W at 20°C
Filled Weight:	1,225 kg (2,701 Lb)	Temperature Capacities:	40°C (104°F)	Working Pressure:	1.2PSI (0.08Bar)

NOTE: The above heating rate is based on a lab test conducted with an ambient temperature of 25°C (77°F) and above.

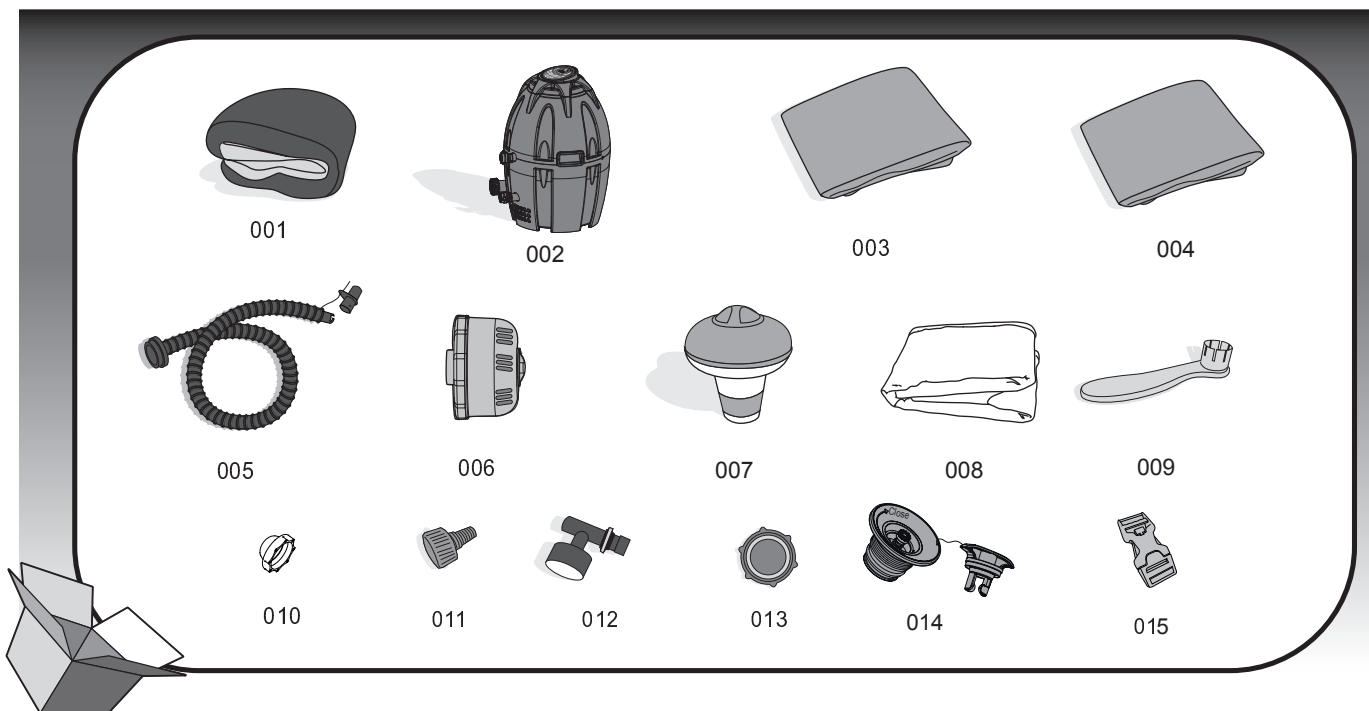

Part N.	Part Code	Description	QTY
001	54129TASS16	Pool liner	1
002	P4B079ASS16	SPA Heater	1
003	P5B401ASS16	Top Leatheroid Cover	1
004	54129GASS15	Inflatable Cover	1
005	P6930	Inflation Hose	1
006	P6653	Filter Set	1
007	58210SA10	Chemical Floater	1
008	58321(H) S15	Ground mat	1
009	F6H189ASS15	Wrench	1
010	P6575	Stoppers	2
011	P6H565	Hose Adapter	1
012	P61199	Pressure Gauge	1
013	P6611	Cover Adapter A	1
014	P6H971	Inflation Valve	1
015	F6414ASS	Buckle	6

SPECIFICATIONS FOR LAY-Z-SPA™ PARIS (#54148)

Capacity:	4-6 Adults	Massaging Turbo Blower:	800W	Increased Heat Rate:	Approximately 1.5-2°C/h (3-4°F/h)
Water Capacity (80%):	945 L (250 gal)	Heat Element:	2,000W at 20°C	Actual Water Flow:	1,325 L/h (350 gal/h)
Inflated Size:	1.96m x 66cm (77" x 26")	Pump:	50W Circulation Filter Pump	Power Rate:	220-240V AC, 2,050W at 20°C
Filled Weight:	1,215 kg (2,678 Lb)	Temperature Capacities:	40°C (104°F)	Working Pressure:	0.8PSI (0.055Bar)

NOTE: The above heating rate is based on a lab test conducted with an ambient temperature of 25°C (77°F) and above.

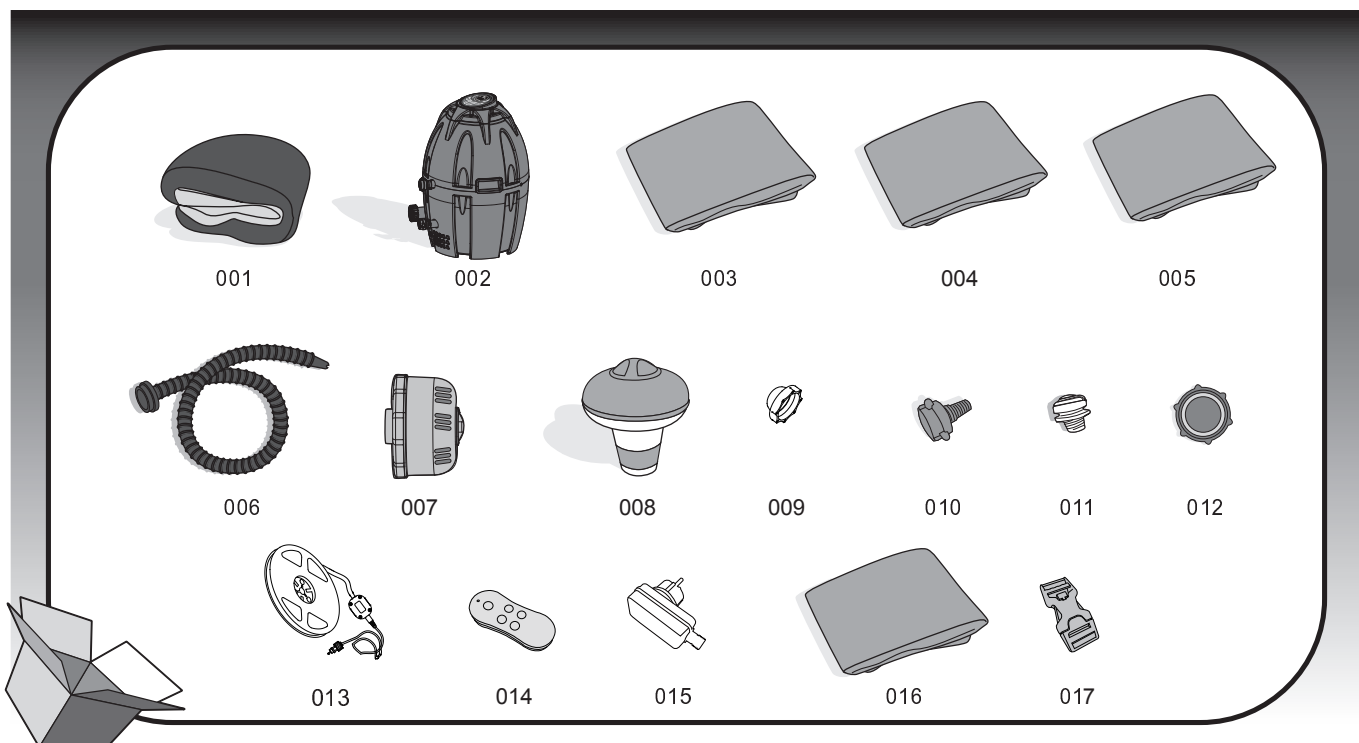

Part N.	Part Code	Description	QTY
001	54148TASS16	Pool liner	1
002	P4H054ASS16	SPA Heater	1
003	P5H284GASS16	Top Leatheroid Cover	1
004	P5H513TASS16	Liner Leatheroid Cover	1
005	54148GASS16	Inflatable Cover	1
006	P6613	Inflation Hose	1
007	P6653	Filter Set	1
008	58210SA10	Chemical Floater	1
009	P6575	Stoppers	2
010	P6932	Hose Adapter	1
011	F4A024ASS	Screw Valve	1
012	P6611	Cover Adapter A	1
013	P61324	LED Strip	1
014	P61232	Remote control	1
015	P61230	Transformer	1
016	58321(H)S15	Ground mat	1
017	F6414ASS	Buckle	8

INSTALLATION

Selected Location

WARNING: The selected location has to be able to support of supporting the expected load.

WARNING: An adequate drainage system has to be provided to deal with overflow water for both indoor and outdoor installations.

IMPORTANT: Because of the combined weight of the Lay-Z-Spa, water, and users, it is extremely important that the base where the Lay-Z-Spa is installed is smooth, flat, level and capable of uniformly supporting the weight for the entire time the Lay-Z-Spa is installed (not on the carpet or other similar material). If the Lay-Z-Spa is placed on a surface, which does not meet these requirements, any damage caused by improper support is not covered under the manufacturer's warranty. It is the responsibility of the Lay-Z-Spa owner to assure the integrity of the site at all times.

1. Indoor Installation:

Be aware of special requirements if you install the spa indoors.

- Humidity is a natural side effect with Lay-Z-Spa installation. Determine the effects of airborne moisture on exposed wood, paper, etc. in the proposed location. To minimize these effects it is best to provide plenty of ventilation to the selected area. An architect can help determine if more ventilation is needed.

2. Outdoor Installation:

- During filling, draining or when in use, water may flow out of the spa. Therefore the Lay-Z-Spa should be installed near a floor drain.
- Do not leave the spa's surface exposed to direct sunlight for long periods of time.

Pump Test

1. Insert the plug into a mains socket. The LED automatically displays current water temperature.
2. Press the "Test" button. All the indicator lights turn off, and the pump gives a warning beep.
3. Unplug and then plug the pump back in to start the system. The pump is ready to use.

WARNING: RISK OF ELECTRIC SHOCK. The pump must be tested before each use.

WARNING: Before inserting plug into a power outlet, make sure the current rate of the power outlet is suitable for the pump.

WARNING: Do not use the pump if this test fails.

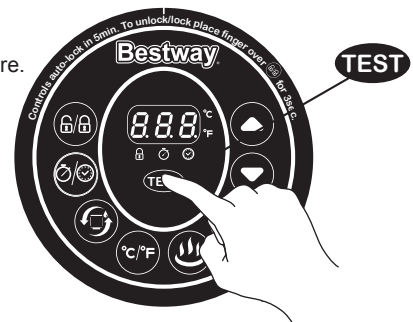

ASSEMBLY

NOTE: When inflating, you will notice that air will be expelled from the area where the air hose connects to the pump, this is normal for technique requirements.

NOTE: Do not use an air compressor to inflate the pool.

NOTE: Inflation time for reference only.

NOTE: Pressure gauge is for inflation purpose only, and the value of the pressure gauge is just for reference, should not be used as a precision instrument.

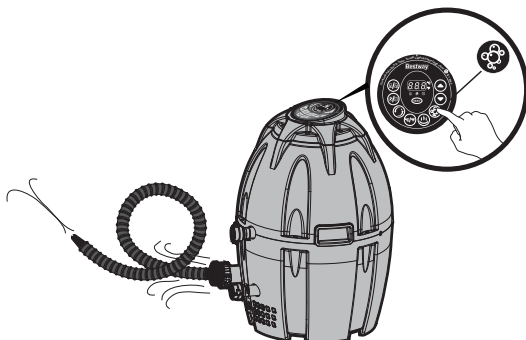

VEGAS (#54112)

1.



2.

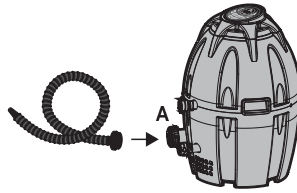

3.

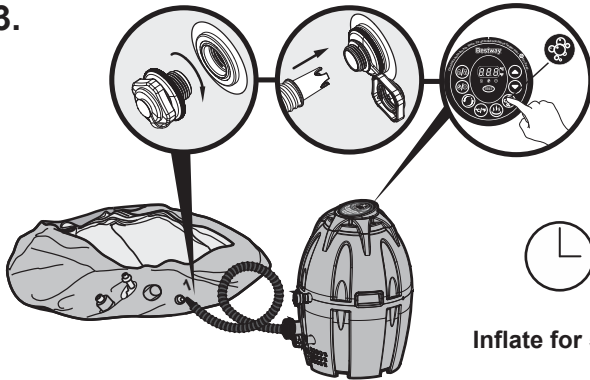

3 seconds to unlock.



4.

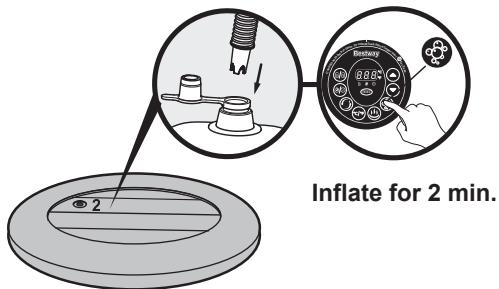

5.

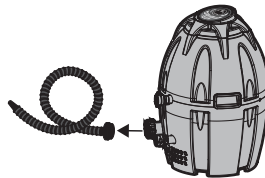

6.

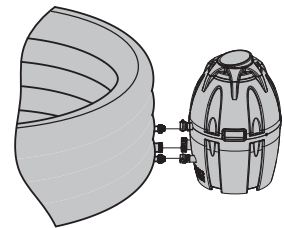

7.

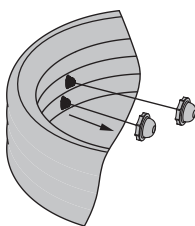

8.

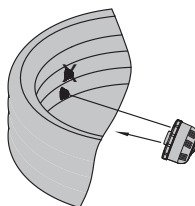

9.

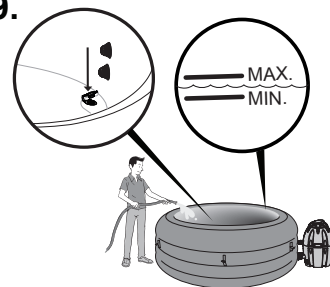

10.

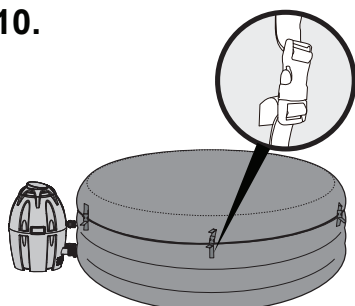

MONACO (#54113)

1.

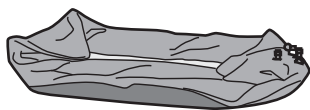

2.

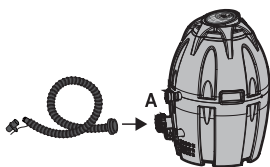

3.

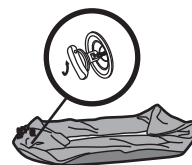

NOTE: Use the pump for pre-inflation

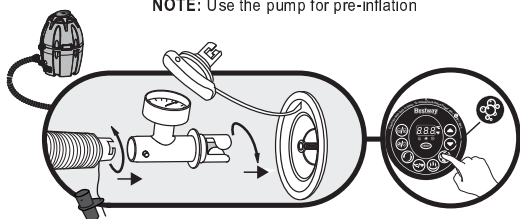

Inflate for 5 min.

3 seconds to unlock.



To stop inflation.

4. NOTE: Complete the inflation with a hand pump.

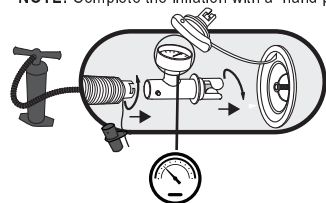

0.48bar (7PSI) ~ 0.69bar (10PSI)

5.

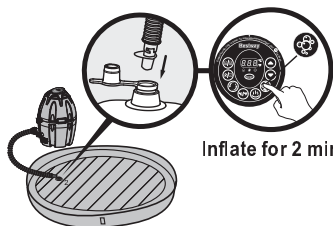

Inflate for 2 min.

6.



7.

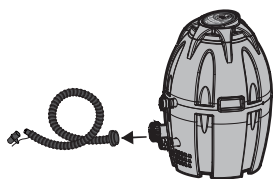

8.

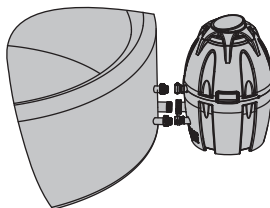

9.

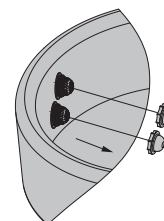

10.

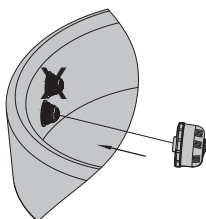

11.

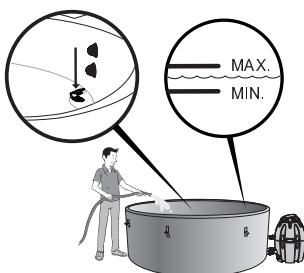

12.

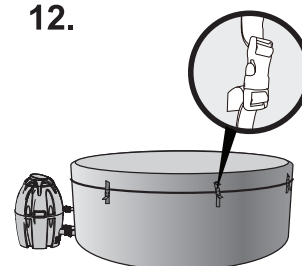

MIAMI (#54123)

1.

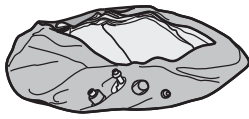

2.

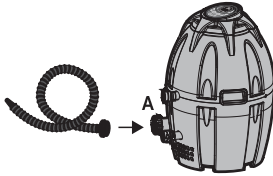

3.

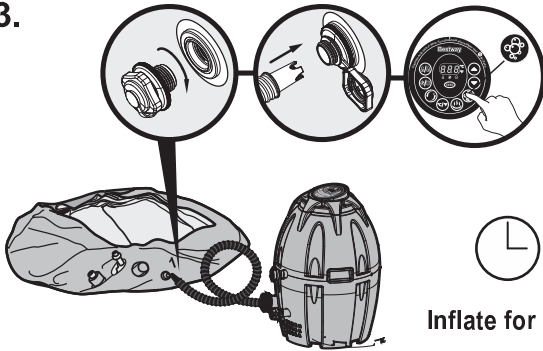

3 seconds to unlock.



4.

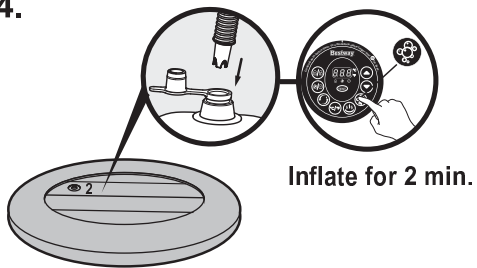

5.

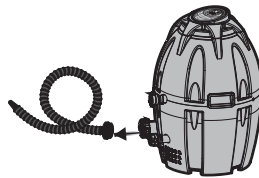

6.

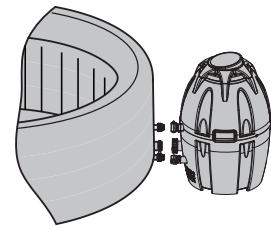

7.

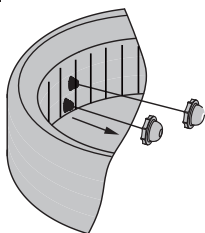

8.

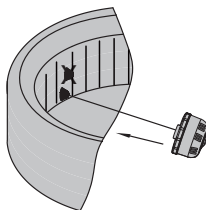

9.

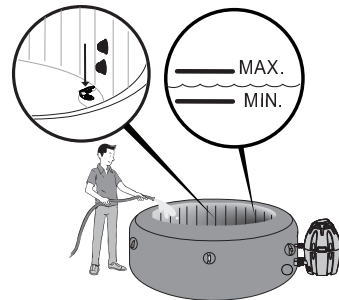

10.

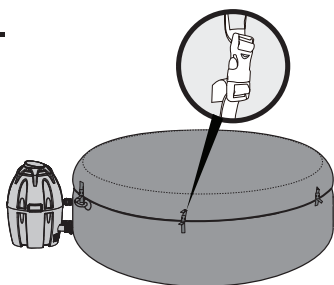

PALM SPRINGS (#54129)

1.

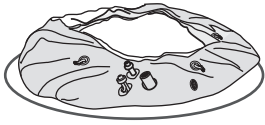

2.

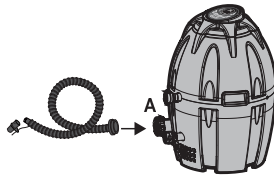

3.

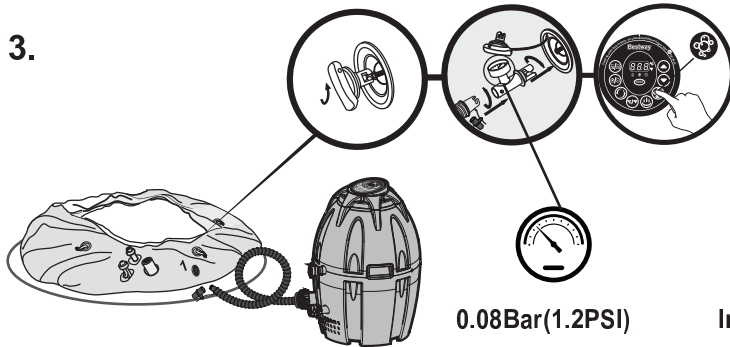

0.08Bar(1.2PSI)

Inflate for 5 min.

3 seconds to unlock.



To stop inflation.

4.

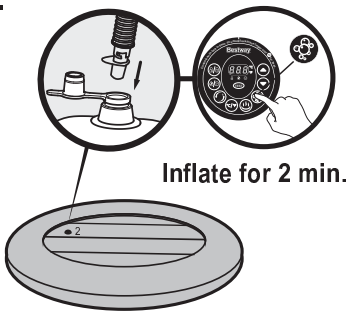

Inflate for 2 min.

5.

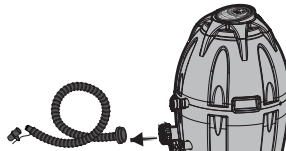

6.

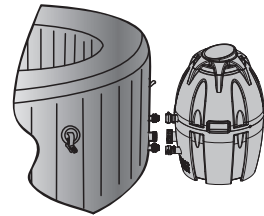

7.

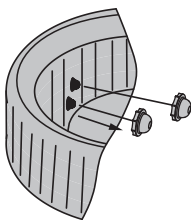

8.

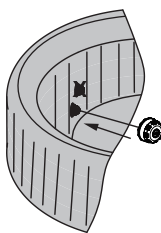

9.

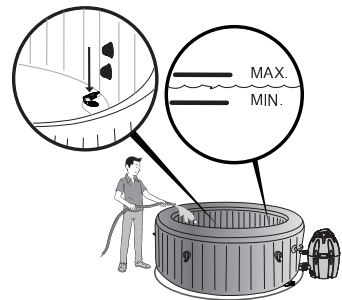

10.

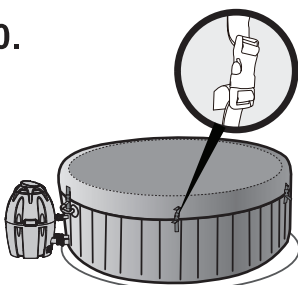

ASSEMBLY: PARIS (#54148)

1.



2.

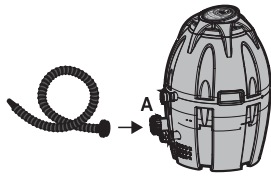

3.

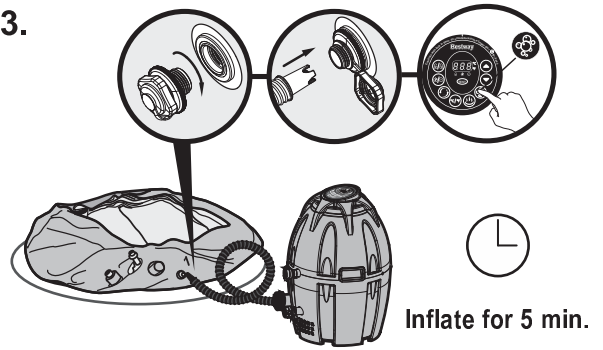

3 seconds to unlock.



To stop inflation.

4.

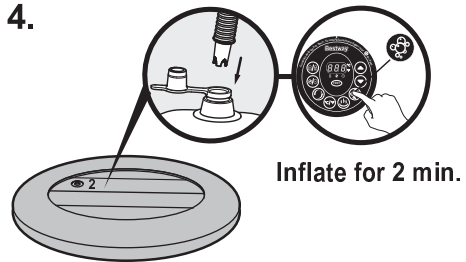

5.

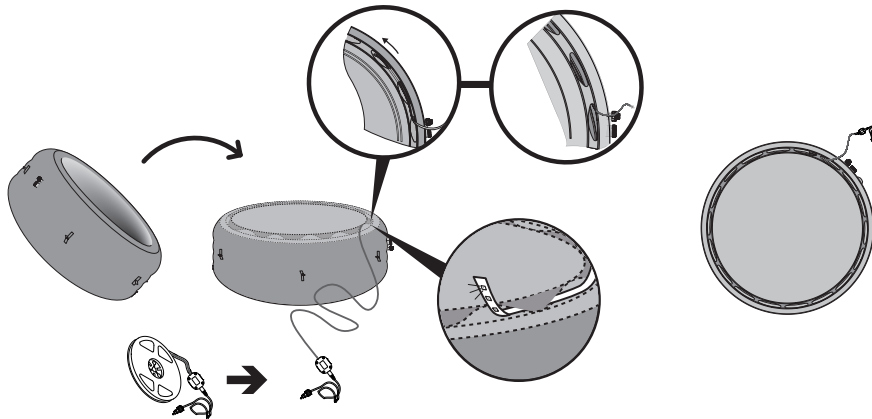

6.

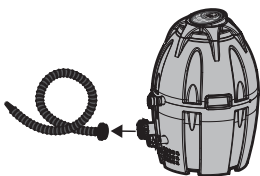

7.

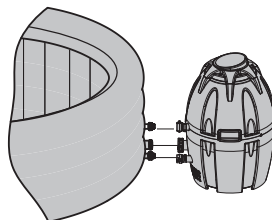

8.

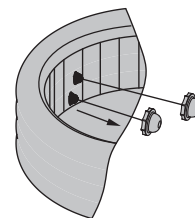

9.

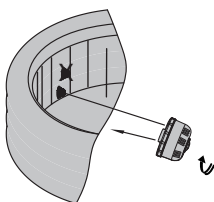

10.

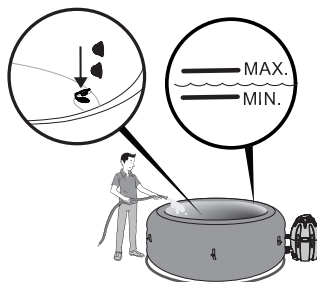

11.

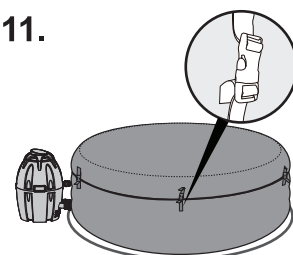

PUMP OPERATION

Heating Reset

When using the Lay-Z-Spa for first time, or after a long period of inactivity, be sure to press the reset button on the pump using a small and thin object.

RESET BUTTON

IMPORTANT INSTRUCTIONS FOR USING

If the temperature on the control panel (or the water temperature) has not changed 4-5 hours after activation of the heating system, use a thin object to press the RESET BUTTON, and restart the heating system.

IMPORTANT: The heating System will not operate if the outside temperature is above 40°C (104 °F) or if the Lay-Z-Spa is under direct sunlight. Under these conditions, please wait until a cooler time of day before pressing the RESET BUTTON with a thin object and restart the heating System.

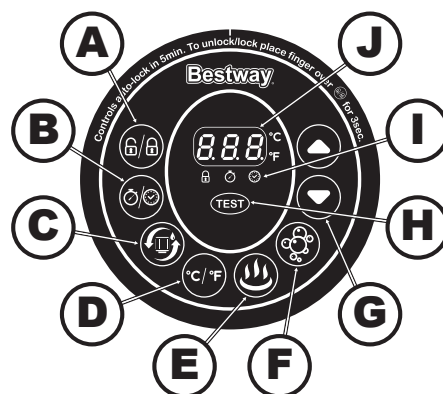
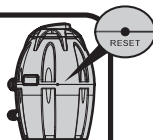

A Lock/Unlock Button

The pump has a 5-minute auto-lock. To lock or unlock the pump, place a finger over the lock/unlock button for 3 seconds.

B Power-Saving Timer Button

Use this button to set the heating duration and when to activate the heating system.

1. Press the button and the LED starts to flash.
2. Press the or button to adjust the heating duration, the time will display in hours.
3. After setting the heating duration, press the button again, the LED starts to flash. Press the or button to adjust the estimate time of activation, press button again or without action for 10 seconds to confirm the setting. The LED maintains.
4. Modify the setting time: Press the button and use the or button to adjust.
5. Press the button for 2 seconds to cancel the setting.

NOTE: After setting, the screen shows the current temperature and time alternately.

NOTE: Timer adjustment ranges from 0 to 48 hours; Reservation time adjustment ranges from 0 to 24 hours. If the timer sets at 0 hour means the Timer function is not set.

C Water Filter Button

This button turns the filter pump on and off. The light above the Water Filter Button displays red when activated.

D Celsius/Fahrenheit Toggle

The temperature can be displayed in either Fahrenheit or Celsius.

E Heat Button

Use this button to activate the heating system. When the light above the heat button is red, the heating system is activated. When the light is green, the water is at the set temperature and the heating system is at rest.

NOTE: If the heating system is activated the filtration system will automatically start.

NOTE: After turning off the heating system the filtration system will continue to operate.

NOTE: The Lay-Z-Massage System will automatically shutoff when the heater is activated.

F Lay-Z-Massage System Button

Use this button to activate the massage system, which has a 30-minute auto-shutoff feature. The light above the Lay-Z-Massage System Button displays red when activated.

IMPORTANT: Do not run the Lay-Z-Massage system when the cover is attached. Air can accumulate inside the spa and cause irreparable damage and bodily harm.

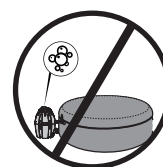

G Temperature Adjustment Buttons

Pressing the Temperature Increase or Decrease buttons will cause the LED to flash. When it is flashing you can adjust to the desired temperature setting. If you hold these buttons down the values will rapidly increase or decrease. The new and desired temperature setting will remain on the LED display for 3 seconds to confirm the new value.

NOTE: The default temperature is 35°C (95°F).

NOTE: Temperature adjustment ranges from 20°C (68°F) to 40°C (104°F).

H Test Button

Use this button to test if the pump electrical system is safe. See Pump Test section for details.

I Power-Saving Timer LED

When the light flickers, the Power-Saving Timer function is being set. When the light is on, the Power-Saving Timer function is set.

J LED Display

Once powered-up the LED displays the current water temperature automatically.









After 72 hours of operation, the pump will hibernate and flash "End" with the current water temperature. When the pump is hibernating both the heating and water filter functions are disabled. To re-activate the pump press lock/unlock button for 3 seconds.

NOTE: The water heat rate may change in the conditions below:

- When the outdoor temperature is below 15°C (59°F).
- If the cover is not in position when the heating function is activated.

NOTE: To display the current water temperature, run the filter system for at least a minute. The water temperature as tested by an external thermometer may vary from the temperature as displayed on the spa panel by as much as approximately 2°C.

Alarms

Causes		Reasons	Solutions
	The water flow sensors work without pressing the filter or heat button.	<ol style="list-style-type: none"> 1. The water flow sensors' flags didn't fall back into the correct position 2. The water flow sensors are broken 	<ol style="list-style-type: none"> 1. Unplug the plug gently, strike the side of the pump but not violently, and plug it back in 2. Contact your local Bestway After Sales service point to get instructions
	After starting or during the functions of filtering or/and heating, the water flow sensors do not detect water flow.	<ol style="list-style-type: none"> 1. You forgot to remove the 2 stopper caps from inside the pool 2. Filters cartridges are dirty 3. Activate the filter or heat system and put your hand in front of the outlet pipe inside the pool to check if you can feel water flowing out <ol style="list-style-type: none"> a. If no water flows out the water pump is broken b. Water flows out but the alarm  appears The water flow sensors are broken 	<ol style="list-style-type: none"> 1. Remove the 2 stopper caps before heating, refer to Assembly section in the User's Manual 2. Remove the filter set from inside the pool and push the filter or heat button. If no alarm appears, clean or change the filter cartridges install the filter set inside the pool. 3. Contact your local Bestway After Sales service point to get instructions
	The pump's thermometer reads the water temperature below 4°C (40°F).	<ol style="list-style-type: none"> 1. The water temperature is lower than 4°C (40°F) 2. If the water temperature is higher than 7°C (44.6°F), the pump's thermometer is broken 	<ol style="list-style-type: none"> 1. The spa is not designed to operate with water temperatures lower than 4°C (40°F). Unplug the pump and only re-start the pump when the water temperature reaches 6°C (43°F) 2. Contact your local Bestway After Sales service point to get instructions
	The pump's thermometer reads the water temperature over 50°C (122°F).	<ol style="list-style-type: none"> 1. The water temperature is over 50°C (122°F) 2. If the water temperature is lower than 45°C (113°F), the pump's thermometer is broken 	<ol style="list-style-type: none"> 1. The spa is not designed to operate with water temperatures greater than 40°C (104°F). Unplug the pump and only re-start the pump when the water temperature reaches 38°C (100°F) or lower. IMPORTANT: Before you re-start the pump, push the pump's reset button 2. Contact your local Bestway After Sales service point to get instructions
	The pump's thermometer connections have issues.	<ol style="list-style-type: none"> 1. The pump's thermometer connectors don't work properly 2. The pump's thermometer is broken 	Contact your local Bestway After Sales service point to get instructions
	This alarm appears after pressing the pump's test button or during the automatic operations of the pump.	<ol style="list-style-type: none"> 1. The power port experienced some temperately current variation 2. Safety components are broken 	<ol style="list-style-type: none"> 1. Unplug and plug the pump back in 2. Contact your local Bestway After Sales service point to get instructions
	The manual reset thermal cut-out has problem.	The manual reset thermal cut-out trips off	<ol style="list-style-type: none"> 1. Unplug the pump and push the reset button, then plug the pump backin. 2. In case the alarm still remains, check the RESET BUTTON section in manual. 3. Contact your local Bestway After Sales service point to get instructions.
All lights on the control panel are off and the pump beeps	Safety circuits operation.	1. The test button was pushed	1. Unplug and plug the pump back in

MAINTENANCE

CAUTION: YOU MUST ENSURE THE PUMP IS UNPLUGGED BEFORE BEGINNING SPA MAINTENANCE TO AVOID RISK OF INJURY OR DEATH.

Filter Cartridge Maintenance

NOTE: To ensure your spa water stays clean, check and clean your filter cartridges every day follow the steps below.

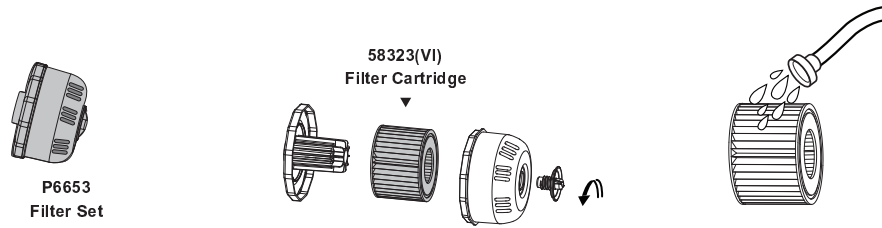

NOTE: We recommend changing your filter cartridges every week or, if the filter cartridges remain soiled and discolored, they should be replaced.

Water Maintenance

Keeping your SPA water clean and chemically balanced is necessary. Simply cleaning the filter cartridge is not enough for proper maintenance, we recommend you use pool chemicals to maintain water chemistry and chlorine or bromine tablets (do not use granules) with the chemical floater. As a guide, the water should be changed about every 3 days. This is only a guide; water quality is influenced by frequency of use, persons using the spa and general maintenance.

Note: We recommend you take a shower before using your Lay-Z-Spa, as cosmetic products, lotions, and other residues on the skin can quickly degrade water quality.

To use the chemical floater, please follow the below instruction.

Using chemical tablets:

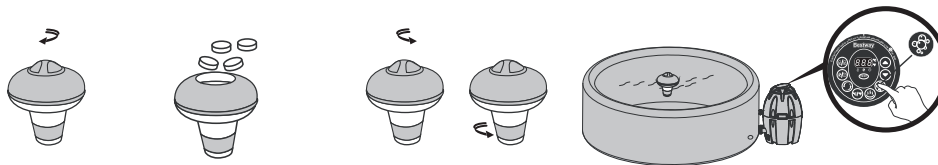

Using chemical liquid:

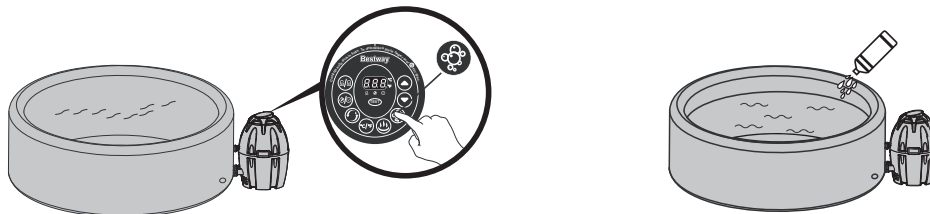

NOTE: Remove the chemical floater from spa when the spa is in use.

IMPORTANT: After performing chemical maintenance and before using the spa, use a test kit (not included) to test the water chemistry. We recommend maintaining your water as table below.

pH	Total Alkalinity	Free Chlorine
7.4-7.6	80-120 ppm	2-4 ppm

NOTE: Damage resulting from chemical imbalance is not covered by the warranty. Pool chemicals are potentially toxic and should be handled with care. There are serious health risks from chemical vapors and the incorrect labeling and storage of chemical containers. Please consult your local pool supply retailer for more information about chemical maintenance. Pay close attention to the chemical manufacturer's instructions. Spa damage resulting from misuse of chemicals and mismanagement of spa water is not covered by the warranty.

Air-Valve Adjustment (For #54113 #54129 Only)

In case of air leakage, check the air-valve first. Using soapy water, cover the air-valve to check if air is leaking, if so, use the provided wrench to fasten the air-valve following these steps:

- With one hand, hold the backside of the air-valve from the inner side of the spa wall and turn the wrench clockwise.

NOTE:

1. Do not over tighten.
2. Always check the air-valve carefully before use.
3. Do not adjust the air-valve connector when the spa is in use.

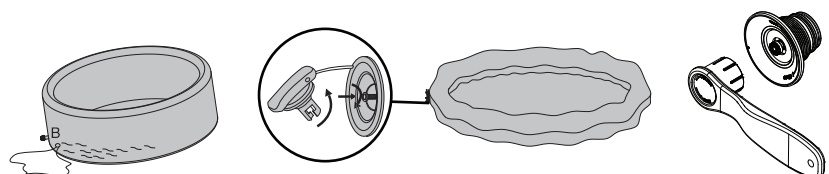

Draining the Spa

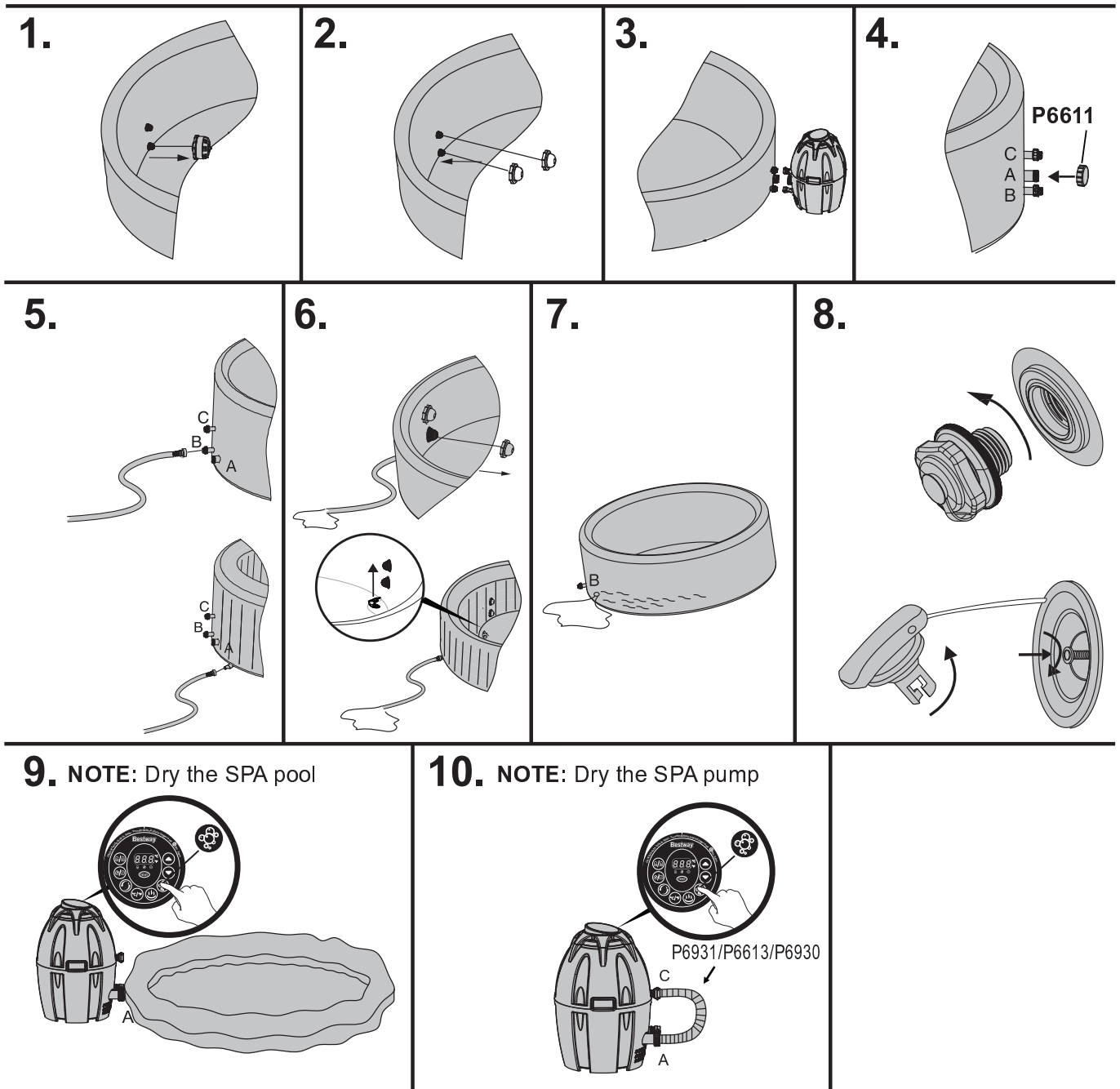

Cleaning the spa

Detergent residues and dissolved solids from bathing suits and chemicals may build up on the spa walls. Use soap and water to clean the walls and rinse thoroughly.

NOTE: DO NOT use hard brushes or abrasive cleaners.

Spa Repair

For Spa #54112, #54123 and inflatable cover #54113, #54129, #54148

If the spa is torn or punctured, use the provided heavy-duty repair patch.

1. Clean area to be repaired.
2. Carefully peel patch.
3. Press patch over area to be repaired.
4. Wait 30 seconds before inflation.

For Spa #54113, #54129 (Not including inflatable cover)

If the spa is torn or punctured, use the provided PVC repair patch and glue (not included) following these steps:

1. Clean and dry area to be repaired.
2. Cut the provided PVC patch to appropriate size.
3. Use glue (not included) to coat the one side of the newly cut patch. Make sure the glue is evenly distributed.
4. Wait for 30 seconds and then place the cut patch with glue over the damaged area.
5. Smooth out any bubbles of air that may be trapped underneath, and press firmly for two minutes.
6. The product is once again ready for use. Repeat this process should further leaks occur.
7. Wait 30 minutes before inflation.

Lay-Z-Spa Storage

Make sure the spa and pump are completely dry. This is essential to extend the life of the spa. We recommend using the pump to blow dry the spa, pump and pipes. Remove the filter sets and discard the used filter cartridges. Re-attach the two stopper caps onto the spa's inlet and outlet valves. It is recommended you store the spa in its original package in a warm dry place.

NOTE: Plastic becomes brittle and susceptible to breaking when exposed to subzero temperatures. Freezing can severely damage the spa. Improper winterization of your spa can void your warranty.

Disposal



Meaning of crossed-out wheeled dustbin symbol: Do not dispose of electrical appliances as unsorted municipal waste, use separate collection facilities. Contact your local government for information regarding the collection systems available. If electrical appliances are disposed of in landfills or dumps, hazardous substances can leak into the groundwater and get into the food chain, damaging your health and well-being. When replacing old appliances with new ones, the retailer is legally obligated to take back your old appliance for disposals at least free of charge.

TROUBLESHOOTING Bestway strives to provide the most trouble-free spas on the market. If you experience any problems whatsoever, do not hesitate to contact Bestway or your authorized dealer. Here are some helpful tips to help you to diagnose and rectify some common sources of trouble.

Problems	Probable Causes	Solutions
Pump does not operate	<ul style="list-style-type: none"> - Power failure - Test Button is pushed - Power circuits broken 	<ul style="list-style-type: none"> - Check power source - Unplug and plug the pump back in - Contact your local Bestway After Sales service point to get instructions
Pump does not heat properly	<ul style="list-style-type: none"> - Temperature set too low - Dirty Filter Cartridge - Improper water levels - The thermal cut-out cuts off - Heating element failed 	<ul style="list-style-type: none"> - Set to a higher temperature refer to section pump operation - Clean/replace the Filter Cartridge refer to section filter cartridge cleaning and replacement - Add water to specified levels - Press the Reset button on the pump refer to section pump operation - Contact your local Bestway After Sales service point to get instructions
Lay-Z-Massage System does not work	<ul style="list-style-type: none"> - Air Pump is too hot - The Lay-Z-Spa Massage stops automatically - Air pump is broken 	<ul style="list-style-type: none"> - Unplug the pump and wait two hours so the pump has cooled. Insert the plug and press the Lay-Z-Massage System Button - Press the Lay-Z-Massage System Button to reactivate - Contact your local Bestway After Sales service point to get instructions
Pump adapters are not level with the spa adapters	<ul style="list-style-type: none"> - One characteristic of PVC is that it changes shape, which is normal 	<ul style="list-style-type: none"> - Elevate the pump with wood or another type of insulated material to bring the pump's adapters level with the spa's adapters
Spa leakage	<ul style="list-style-type: none"> - Spa is torn or punctured 	<ul style="list-style-type: none"> - Use provided repair patch
Water is not clean	<ul style="list-style-type: none"> - Insufficient filtering time - Dirty Filter Cartridge - Improper water maintenance 	<ul style="list-style-type: none"> - Increase filtration time - Clean/replace the Filter Cartridge refer to section filter cartridge cleaning and replacement - Refer to the chemical manufacturer's instructions

Limited BESTWAY® Manufacturer's Warranty

The product you have purchased comes with a limited warranty. Bestway® stands behind our quality guarantee and assures, through a replacement warranty, your product will be free from manufacturer's defects that result in leaks. To enact a warranty claim, this form must be completed and submitted with a copy of your purchase receipt to your local Bestway After Sales Center. Please contact your local Bestway After Sales Center before sending any document, they will provide full instructions of what is needed for your claim. Bestway® will not replace any products deemed to have been damaged due to negligence or having been used outside of the owner's manual guidelines.

Bestway's warranty covers manufacturing defects discovered while unpacking the product or during use as recommended within the user manual. This warranty applies only to product which must not have been modified by any 3rd parties. The product must be stored and handled in accordance with the technical recommendations.

The warranty does not cover damages caused by misuse, abuse, neglect, including, but not limited to collision, fire, use of incorrect voltage, excessive heat exposure, improper installation, improper wiring or testing, improper storage.

Replacements and repairs don't extend the duration of the warranty. The date to be considered as the start of the warranty is only the one shown in the original receipt/purchase invoice.

Please choose your SPA

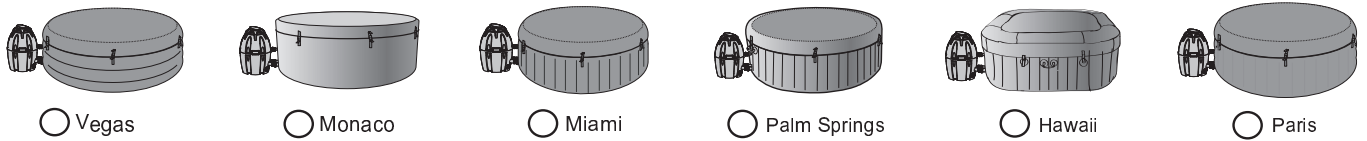

TO: Bestway® Service Department Date of purchase receipt: _____
 DATE _____ Customer Code Number _____

FAX/E-MAIL/TEL: Please refer to your country according to the information you find on the back cover or on our website: www.bestway-service.com

Please provide your address details in full. **Note:** Incomplete address details will result in delayed shipments. Bestway reserves the right to charge for redelivery of undelivered packages where the recipient is at fault.

REQUIRED INFORMATION - PLEASE WRITE THE DELIVERY ADDRESS

Name: _____ Address: _____
 Zipcode: _____ Retailer: _____
 Country: _____ City: _____
 Mobile: _____ Telephone: _____
 Fax: _____ E-mail: _____

SPA PUMP Batch Number: _____ SPA Pool Batch Number: _____
 SPA PUMP Item Code: _____

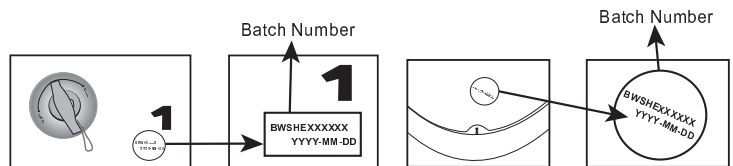
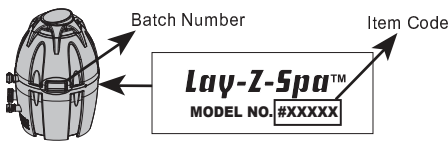

LAY-Z-SPA Vegas

All drawings for illustration purpose only. Not to scale.

Description of Problem

- Spa leaking
 Water Filtration System not working
 Heating System not working
 Control panel shows a failure which cannot be solved
 Lay-Z-Massage System not working
 Pump leaking
 Adapter leaking
 Missing Parts - Please use the code for the missing part, this
 Other (please describe)
 can be found in the owner's manual.

IMPORTANT: ONLY THE DAMAGED PART WILL BE REPLACED, NOT THE COMPLETE SET.

Bestway reserves the right to request photographic evidence of defective parts, or to require the sending of the item for additional testing.

In order to best assist you, we request all information you provide is complete.

FOR FAQ, MANUALS, VIDEOS OR SPARE PARTS, PLEASE VISIT OUR WEBSITE WWW.BESTWAY-SERVICE.COM.
 VIDEOS ARE ALSO AVAILABLE ON OUR BESTWAY CHANNEL ON YOU TUBE: <http://youtube.com/user/BestwayService>.

