

# HYGENA RETRO TABLE

Assembly Instructions - Please keep for future reference

453/8190

**hygena**

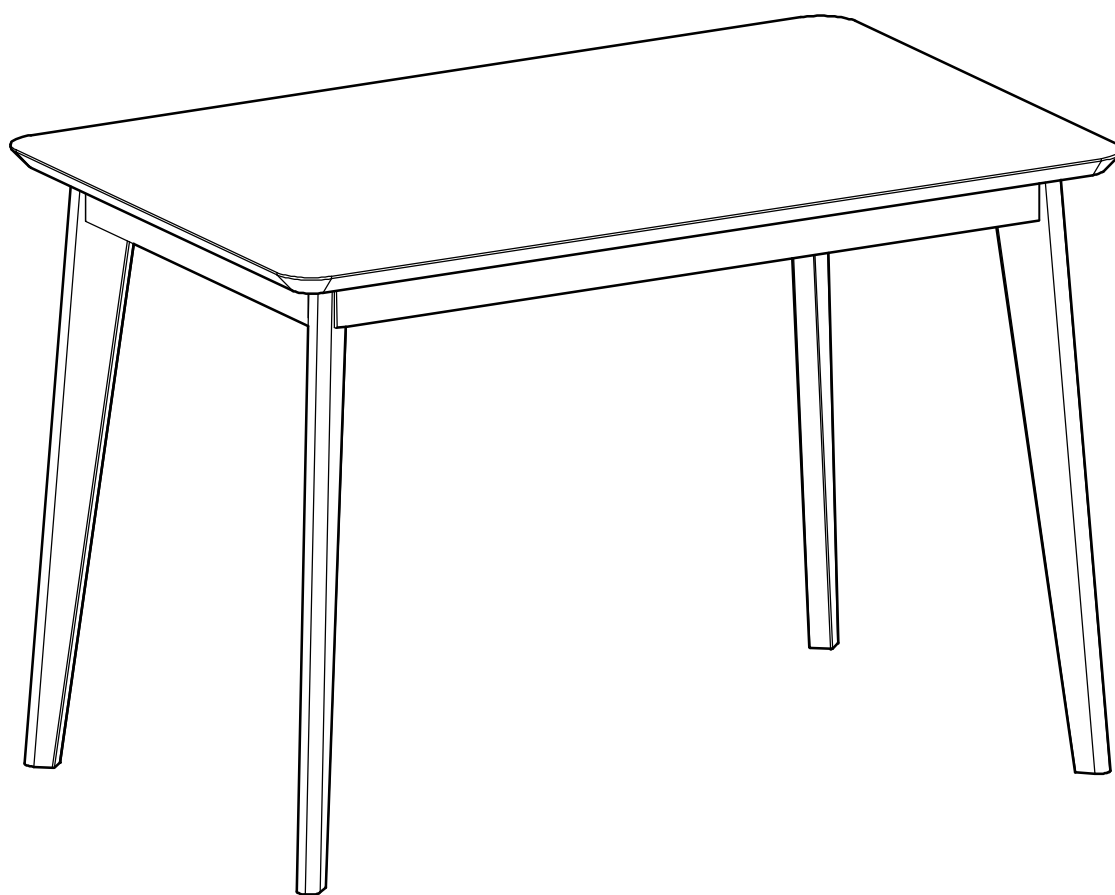

## Dimensions

Width - 76cm  
Length - 120cm  
Height - 75cm

**Important – Please read these instructions fully before starting assembly**

If you need help or have damaged or missing parts, call the **Customer Help line: 0345 6400800**



# Safety and Care Advice

## Important – Please read these instructions fully before starting assembly

- Check you have all the components and tools listed on the following pages.
- Remove all fittings from the plastic bags and separate them into their groups.
- Keep children and animals away from the work area, small parts could choke if swallowed.
- Make sure you have enough space to layout the parts before starting.
- Parts of the assembly will be easier with 2 people.

- During assembly do not stand or put weight on the product, this could cause damage.
- Assemble the item as close to its final position (in the same room) as possible.
- Assemble on a soft level surface to avoid damaging the unit or your floor.



- To reduce the likelihood of damaging your product please **ensure that your** power drill is set on a low torque setting.

## Care and maintenance

- Only clean using a damp cloth and mild detergent, do not use bleach or abrasive cleaners.
- From time to time check that there are no loose screws on this unit.
- This product should not be discarded with household waste. Take to your local authority waste disposal centre.

## Handy Hints

- Assemble all parts and bolts loosely during assembly, only once the product is complete should you fully tighten the bolts.
- Regularly check and ensure that all bolts and fittings are tightend properly.

# Components - Panels

If you have damaged or missing components, call the **Customer Helpline: 0345 6400800**

Please check you have all the panels listed below

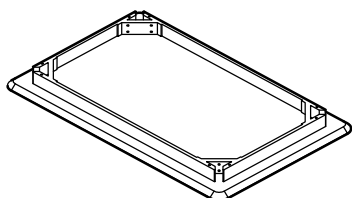





**1** Table top frame  
(120 x76 cm)

**2** Table leg x 4  
(75 x8.7 cm)

# Components - Fittings

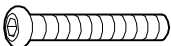
Please check you have all the fittings listed below

**Note:** The quantities below are the correct amount to complete the assembly. In some cases more fittings may be supplied than are required.

<b>A</b>  50mm Bolt x 8	<b>B</b>  Spring washer x 8	<b>C</b>  Plain washer x 8
<b>D</b>  Hex key x 1		

**Ruler - Use this ruler to help correctly identify the screws**

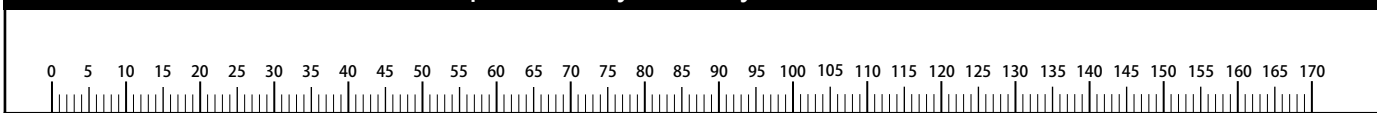

# Assembly Instructions

## Step 1

### Assemble table leg

Parts of the assembly will be easier with 2 people.

Place table top frame **1** upside down on a clean surface.

Fix table legs **2** to table top frame **1** using bolts **A**, spring washers **B**, plain washer **C**.

**Note:** Re-tighten all the bolts.

Turn the table upright.  
Assembly is complete.

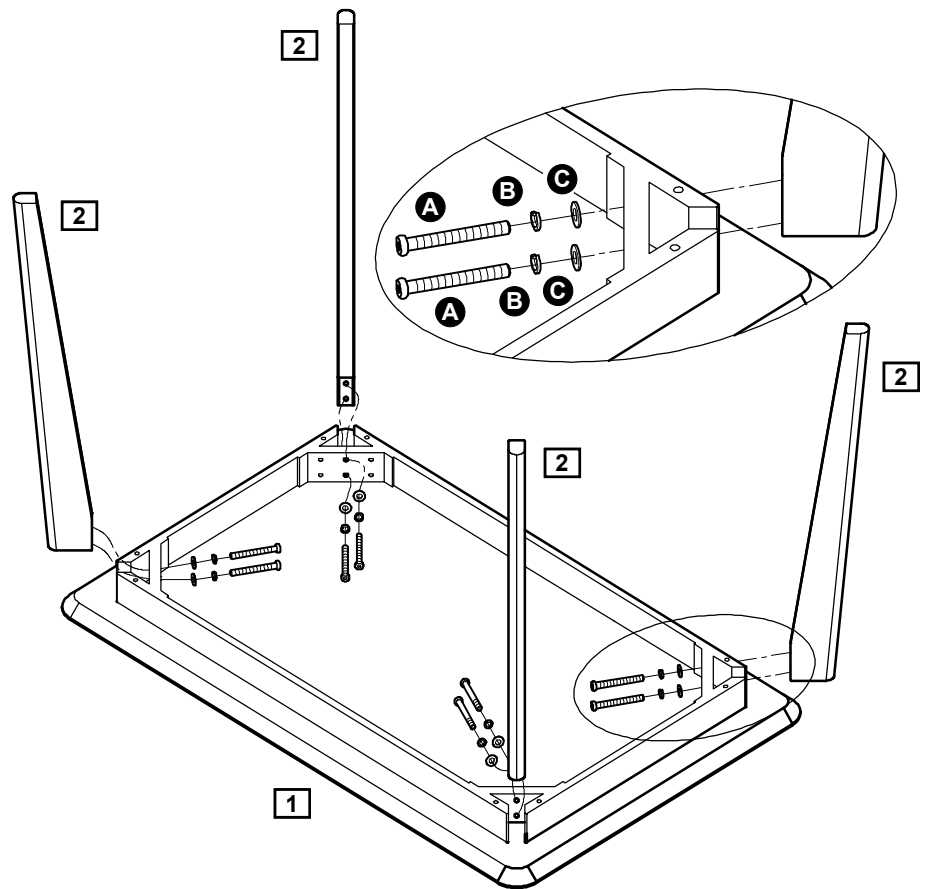

If you need help or have damaged or missing parts, call the **Customer Helpline: 0345 6400800**