

BUSH

Instruction Manual

LE-50GY15-M1



Contents

Safety Information	2 - 3		
Getting Started	4 - 13		
Support	4		
TV Features	5		
Accessories included	5		
Base Stand Assembly Instruction	6		
Viewing remote control - TV	7-8		
TV - Control buttons (Right side)	9		
Aerial connection	9		
Power connection	9		
Remote control - Inserting batteries	10		
Switching the TV On and Off	10		
Operation using TV control buttons	11		
Operation using remote control	11		
		Time Menu	32-34
		Network	34
		Setting Menu	34-36
Connections	12 - 14		
Left sideconnections explained	12		
HDMI Connections	13		
SCART Connections	14		
VGA Connections	14		
First time setup	15		
How to use your TV	16 - 24		
How to navigate menus	16		
Using The Electronic Programme Guide(EPG)	16-17		
Viewing Teletext	18		
Using The Time Shift Function	19-20		
Recording DTV Programmes	20-21		
Using The Programme Timer	21-22		
Watching Recorded Programmes	23-24		
TV systems management	25 - 36		
Picture Menu	25		
Sound Menu	26-27		
Channel Menu	27-31		
Lock Menu	31-32		
		Entertainment Features	39 - 42
		Using The Usb Features	37
		Viewing Movies	38
		Listening to music	39
		Viewing photos	40
		Files	41
		Other information	42 - 45
		Specifications	42
		Digital reception	42
		Plug replacement - UK and Ireland only	43
		Energy label	43
		Trouble shooting	44
		Supported file formats	45
		Disposal information	45

Safety Information

Important - Please read these instructions fully before installing or operating

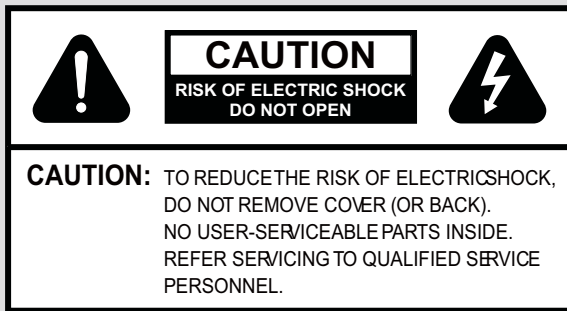

The lightning flash with arrowhead symbol, within an equilateral triangle, is intended to alert the user to the presence of uninsulated "dangerous voltage" within the product's enclosure that may be of sufficient magnitude to constitute a risk of electric shock of persons.



The exclamation point within an equilateral triangle is intended to alert the user to the presence of important operating and maintenance (servicing) instructions in the literature accompanying the appliance.

Power source

- The TV should be operated only from a 100-240V AC, 50 Hz outlet.
- **Warning:** Do not leave your TV in standby or operating mode when you leave your house.

Positioning the TV

- For ventilation, please leave a clear space of at least 10cm all around the TV.

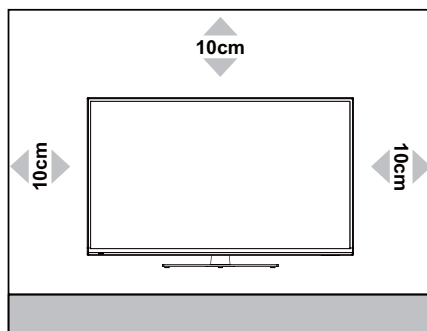

- **Do not** block the ventilation openings.
- Do not place the TV on sloping or unstable surfaces, the TV may tip over.
- To prevent damage to the TV, do not place any objects on top of the TV.
- Only use the TV in moderate climates.

Power cord and plug

- The power cord plug should be easily accessible. In case of storms and lightning, when going on holiday, or when the TV is not used for a long period of time disconnect the power cord from the mains power socket.

- **Do not** place the TV, furniture, etc. on the power cord or pinch the cord.
- Handle the power cord by the plug, do not unplug the TV by pulling the power cord.
- Never touch the power cord/plug with wet hands as this could cause a short circuit or electric shock.
- Never make a knot in the power cord or tie it with other cords.
- Power cords should be placed in such a way that they are not likely to be stepped on or driven over.
- A damaged power cord/plug can cause fire or give you an electric shock. When damaged it must be replaced, this should only be done by qualified personnel.

Moisture and Water

- **Do not** use this TV in a humid or damp place (avoid bathrooms, the sink in the kitchen, and near the washing machine).
- **Do not** expose this TV to rain or water, as this may be dangerous.
- **Do not** place objects filled with liquids, such as flower vases, on top of the TV. Avoid from dripping or splashing.
- If any solid object or liquid falls into the cabinet, unplug the TV and have it checked by qualified personnel before operating it any further.

Ventilation

- The slots and openings on the TV set are intended for ventilation and to ensure reliable operation.
- To prevent overheating, these openings must not be blocked or covered in anyway.

Safety Information

Important - Please read these instructions fully before installing or operating

Heat sources and Flames

- **Do not** expose the TV to direct sunlight or other heat sources.
- The TV should not be placed near to open flames and sources of intense heat such as an electric heater.
- Ensure that no open flame sources, such as lighted candles, are placed on top of the TV.

Headphone volume

- Excessive sound pressure from earphones and headphones can cause hearing loss, please take care.

Wall mounting (optional)

To prevent injury, this TV must be securely attached to the wall in accordance with the installation instructions (if the option is available).

LCD Screen

- The LCD screen is a very high technology product with about a million thin film transistors, giving you fine picture details. Occasionally, a few non-active pixels may appear on the screen as a fixed blue, green or red point. Please note that this does not affect the performance of your product.
- Take care not to scratch the screen with fingernails or other hard objects.

Cleaning

- Before cleaning, unplug the TV from the wall socket.
- **Do not** use liquid or aerosol cleaners. Only use a soft, dry cloth.

Batteries

- **Warning:** Incorrect installation of batteries may cause battery leakage and corrosion, resulting in damage to the remote control.
- **Do not** mix old and new batteries, or batteries of different types.
- **Do not** dispose of batteries in a fire.
- **Do not** dispose of batteries with normal household waste, take to a local recycling centre.



Replacement parts

When replacement parts are required, make sure that the service technician has used replacement parts, which are specified by the manufacturer or have the same specifications as the original one. Unauthorised substitutions may result in fire, electrical shock or other hazards.

Servicing

- **Warning:** Risk of exposure to radiation from class 1/class 3b visible and invisible laser beams. **Do not** open the TV and stare directly into beam.
- **Warning:** Risk of electric shock, do not attempt to repair, service or modify this TV yourself. Contact the manufacturer, their approved service agent or the **Customer Helpline: 0845 604 0105**.

This equipment is a Class II or double insulated electrical appliance. It has been designed in such a way that it does not require a safety connection to electrical earth.

-  **Warning: To prevent the spread of fire, keep candles or other open flames away from this product at all times.**

Getting Started

The Argos Technical Helpline is here to help

Technical experts are available 7 days a week

- **Simple help and advice on setting up your digital equipment (image).**
- **Guidance on connecting other devices to your television such as a DVD player, Sky, home cinema system or a games console.**
- **Order spare parts, including that lost remote control.**
- **Any other technical issues you may need assistance with.**

Call us today: 0345 604 0105

Local call rates applies*

Lines open 9am-8pm Monday to Saturday and 10am-4pm Sunday.

*Calls to Argos enquiry lines may attract a charge and set up fee from residential lines depending on your call plan/tariff. Mobile and other providers costs may vary, see www.bt.com/pricing for details.

For Security and training purposes, telephone calls to and from customer service centres maybe recorded and monitored. Calls from Republic of Ireland will attract international call charges.

Getting Started

TV - Features

- Remote controlled colour LCD TV.
- Fully integrated digital TV (DVB-T).
- HDMI connectors for digital video and audio. This connection is also designed to accept high definition signals.
- USB input.
- 100 programmes from VHF, UHF (analogue).
- 400 programmes for digital mode (DTV).
- OSD menu system.
- Scart socket for external devices (such as video, video games, audio set, etc.).
- Stereo sound system.
- Teletext, fasttext, TOP text.
- Headphone connection.
- Automatic programming system.
- Forward or backward manual tuning.
- Sleep timer.
- Child lock.
- AVL (Automatic Volume Limiting).
- PLL (Frequency Search).
- PC input.
- Plug & Play for Windows 98, ME, 2000, XP, Vista.

Accessories included

- TV



- Stand Support

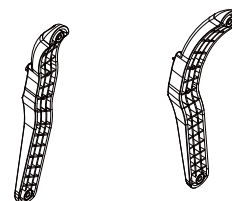

- Screw (4PCS)

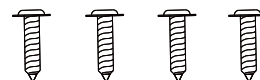

- MINI YPBPR Cable

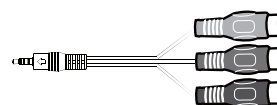

- MINI AV Cable

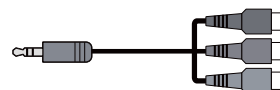

- Remote Control
- Batteries: 2 x AAA

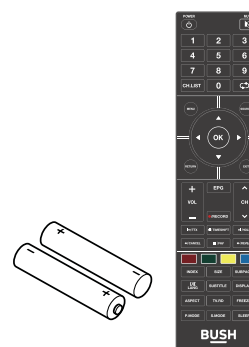

- Instruction Book

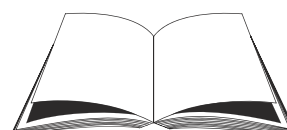

Getting Started

Installing / Removing the Base Stand

Base Stand Assembly Instruction

1. Place the TV with the display side down on a flat surface. Use a cloth to protect. Locate the bottom at the stand.
2. Fix the stand base to the TV with the 2PCS provided screws.
3. Fix the right base stand assembly to the TV using the 2 pcs provided screws.

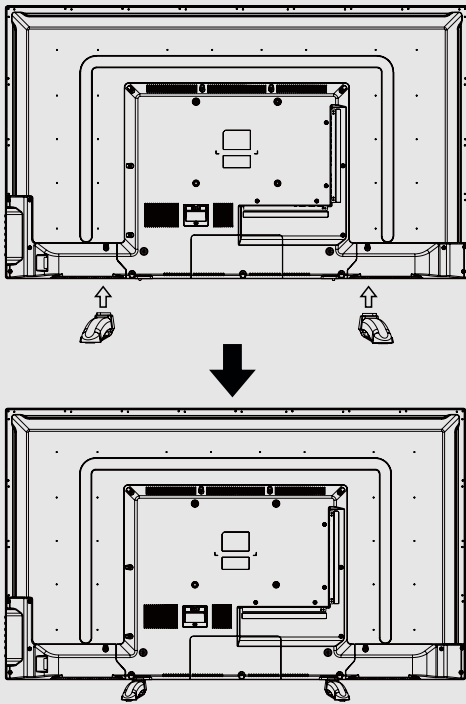

INSTALLATION NOTES

This TV can be connected to an AC 100-240 Volts, 50/60 Hz power supply. Never connect straight to a DC power supply.

Locate the TV in a room where light does not strike the screen directly. Total darkness or a reflection on the screen can cause eyestrain. Soft and indirect lighting is recommended for comfortable viewing.

Allow enough space between the TV and the wall to permit ventilation.

Avoid excessively warm locations to prevent possible damage to the cabinet or premature component failure.

WALL MOUNTING INSTALLATION GUIDELINES

This television can be wall mounted as follows:

1. Place the LED LCD Television onto a solid surface. Please place some soft material over the front of the screen to protect it from any damage.
2. Remove the screws (4PCS) from the lower part of the television, where the base joins to the TV, and take away the stand (put the stand somewhere safe for future use).

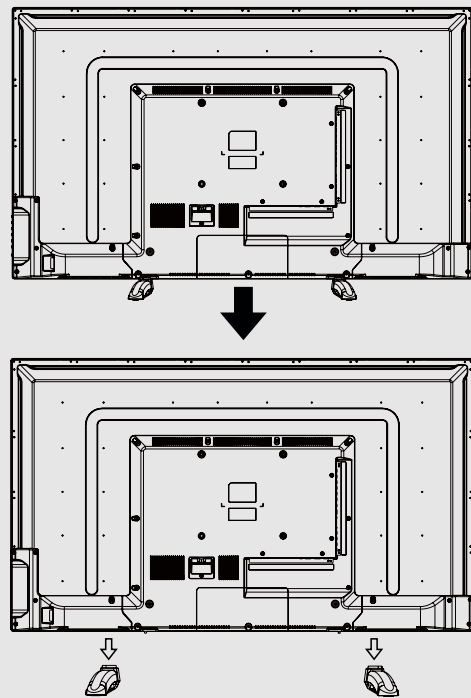

3. Use the 4PCS provided screws to fix the TV onto a wall mounting bracket (not included) via the four VESA standard holes on the back of the television.

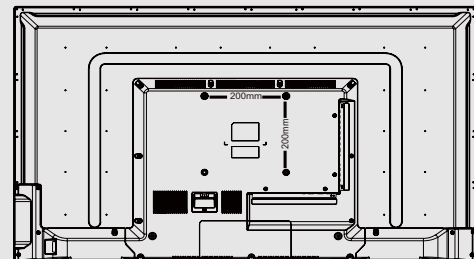

200 x 200mm VESA mount

Getting Started

Viewing remote control - TV

1. : Switch the TV between on and standby mode.
2. : Mutes and restores your TV sound.
3. **0-9 Number Button**: Use to select a programme. (ATV / DTV mode)
4. **CH.LIST**: Display programme list. (ATV / DTV mode)
5. : Go back to the previous viewing channel.
6. **MENU**: Display the main menu
7. **SOURCE**:
Select among the different input signal sources: DTV / Analogue TV / Composite/AV / SCART/ Component / YPbPr / HDMI 1 / HDMI 2 / HDMI 3 / HDMI 4.
8. **OK**: Confirm the selection.
: Allows you to navigate through the OSD menu and adjust the TV 's settings to your preference.
9. **RETURN**: Return to previous menu.
10. **EXIT**: Exit the OSD menu.
11. **EPG**: Display the Electronic Program Guide (DTV mode).
12. **VOL + / -**: Adjust the volume.
13. **CH ^ / v**: Select a channel.
14. **RECORD**: One button recording function, press to record current program (DTV mode).
15. **PAUSE**: Start or pause playback (USB / DTV modes).
TIMESHIFT: Press to turn the timeshift function on and off (DTV mode).
16. **SKIP**: Press to skip to the beginning of the previous chapter or track (USB / DTV modes).
TTX: Turn on and off the teletext function. (ATV/DTV Modes)
17. **SKIP**: Press to skip to the beginning of the next chapter or track (USB / DTV modes).
HOLD: Press to freeze a multi-page Teletext passage on screen (DTV / AV / SCART modes).
18. **REWIND**: Press to fast rewind (USB / DTV modes).
CANCEL: Press to cancel the Teletext mode (DTV / AV / SCART modes)
19. **STOP**: Press to stop playback (USB / DTV / ATV modes).
FAV: Press to show your Favourite Channels list (DTV / ATV modes).
20. **FAST FORWARD**: Press to fast forward (USB / DTV modes).
REVEAL: Press to reveal hidden information such as answers to quiz on Teletext (DTV / AV / SCART modes).
21. **RED / GREEN / YELLOW / BLUE**: Use these buttons to select corresponding function shown on screen and in menus.
22. **INDEX**: Press to select the page number of the index from Teletext (DTV mode).
23. **SUBPAGE**: Press to display the subpage on the Teletext screen (DTV / AV / SCART modes).

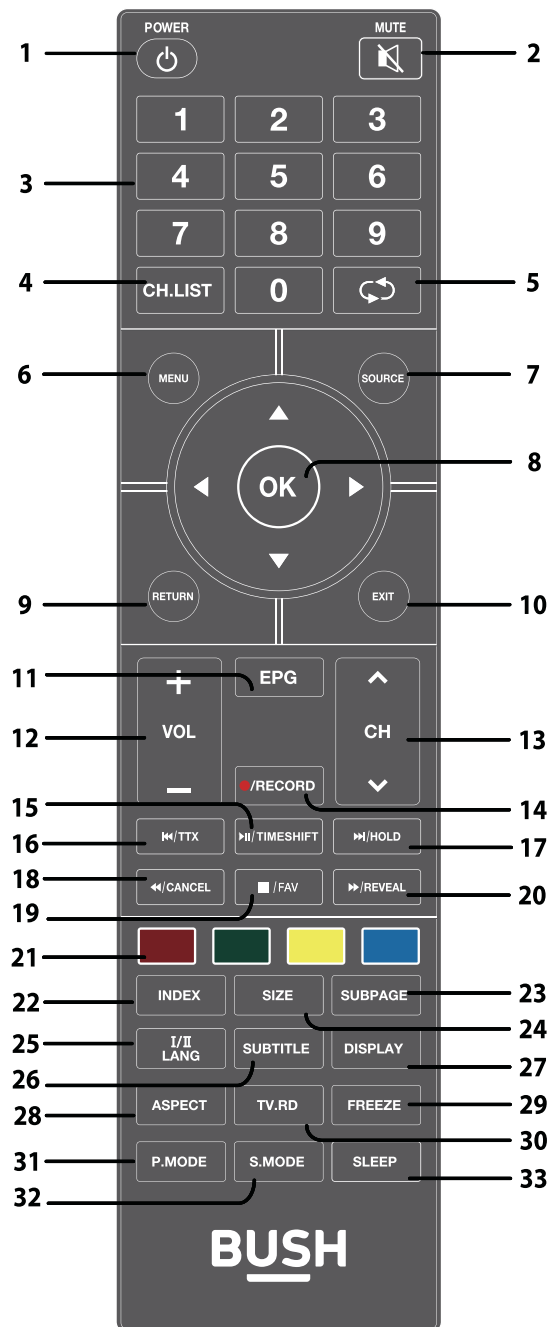

Getting Started

Viewing remote control - TV

- 24. SIZE:** Press to enlarge the picture on the TV Teletext (DTV / AV / SCART modes).
- 25. LANG:** Select the DTV audio language (DTV mode).
- I/II:** Press to switch between different audio languages (only applicable when the broadcast supports this function).
- 26. SUBTITLE:** Press to display information about the current screen such as current channel or input source.
- 27. DISPLAY:** Press to show information about the current screen such as current channel or input source.
- 28. ASPECT:** Select from the following settings: Auto / 4:3 / 16:9 / Zoom 1 / Zoom 2.
- 29. FREEZE:** Freeze the picture.
- 30. TV.RD:** Press to select between TV and Radio programs (DTV mode).
- 31. P.MODE:** Press to select picture mode.
- 32. S.MODE:** Press to select sound mode.
- 33. SLEEP:** Press to set TV's sleep timer.

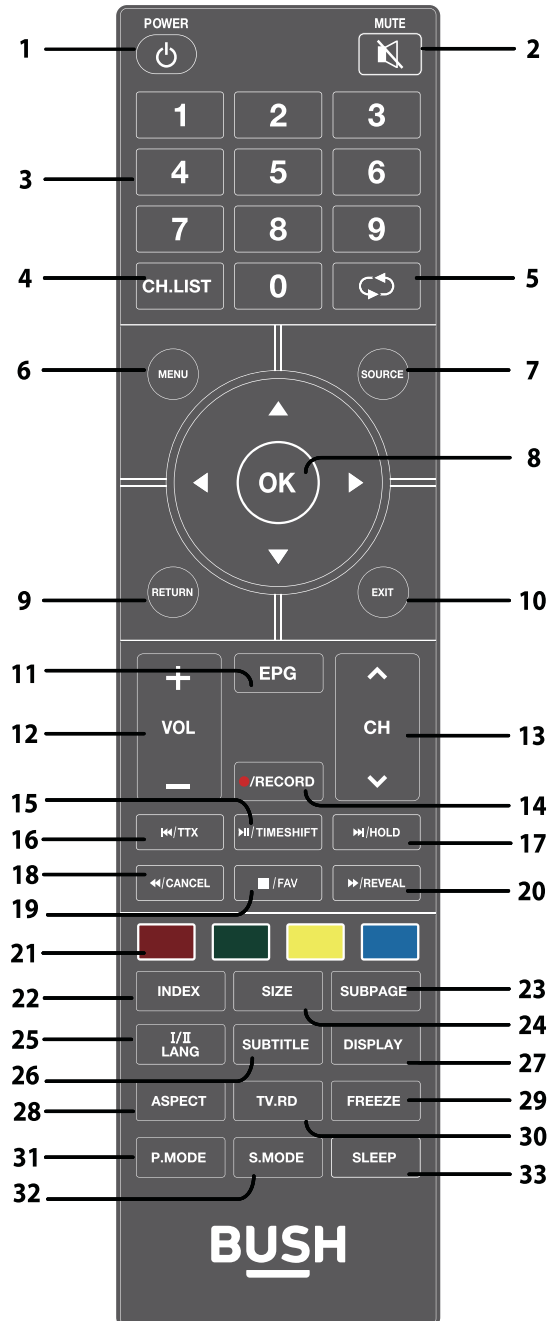

Getting Started

TV - Control buttons (Right side)

1. VOL+ button

Increases the volume.

2. VOL- button

Decreases the volume.

3. CH+ button

Moves up a channel.

4. CH- button

Moves down a channel.

5. MENU button

Displays the OSD (on screen display) menu.

6. SOURCE button

Press to select among different input signal sources:
Select among the different input signal sources:DTV / Analogue TV / Composite/AV / SCART/ Component /YPbPr / HDMI 1 / HDMI 2 / HDMI 3 / HDMI 4.

Confirmed the selection on OSD menu.

7. button

Turns the TV on when in standby mode or turns the TV off into standby mode.

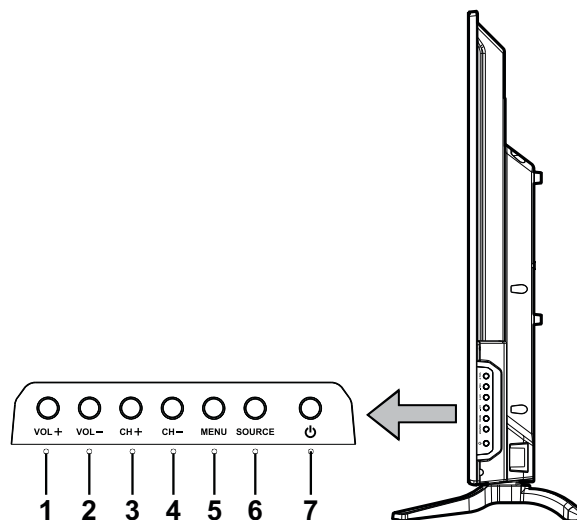

Aerial connection

Connect the "aerial" or "cable TV" plug to AERIAL INPUT (ANT.) socket located on the back of the TV .

Power connection

Please note: After unpacking, allow the TV to reach ambient room temperature before connecting the TV to the mains power socket.

Connect the power cord plug to the mains power socket.

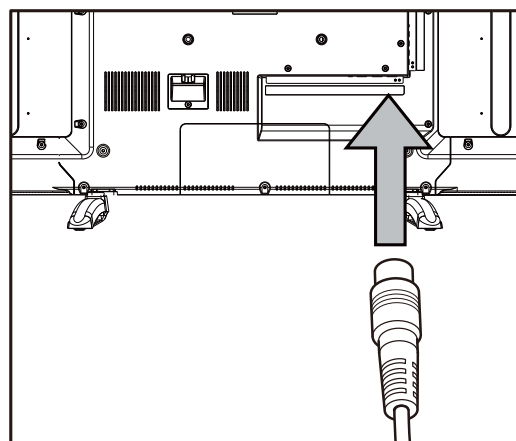

Getting Started

Remote control - Inserting batteries

Remove the battery cover on the back of the remote control, gently push down and pull backwards at the same time as shown.

Insert two AAA/R3 or equivalent type batteries. Ensure the batteries are inserted the correct way and replace the battery cover.

Note: *When the remote control is not going to be used for long periods of time, the batteries should be removed. Otherwise the remote control may be damaged, caused by battery leakage and corrosion.*

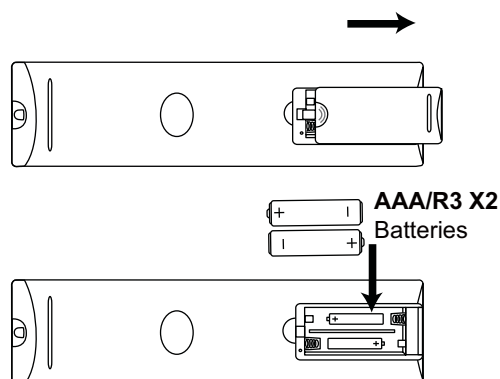

Switching the TV On and Off

Switching the TV On

With power cord plug connected to the mains power socket and TV in '**Standby**' mode.

To switch the TV on from standby mode, either:

a: The Remote control; Press the “⏻” button.

b: The TV; Press the “⏻” button at the bottom of the TV.

Switching the TV Off

Either press the “⏻” button on the remote control or press the “⏻” button at the bottom of the TV, the TV will then switch to standby mode.

Getting Started

Operation using TV control buttons

The **VOL+/VOL-** buttons will function as volume up/down as default. Even if you set other functions for these buttons, the **VOL+/VOL-** buttons will return to volume control after a short while.

Volume Setting

Press **VOL+/VOL-** buttons to increase or decrease volume.

Programme Selection

Press **CH+/CH-** buttons to select the next or previous programme.

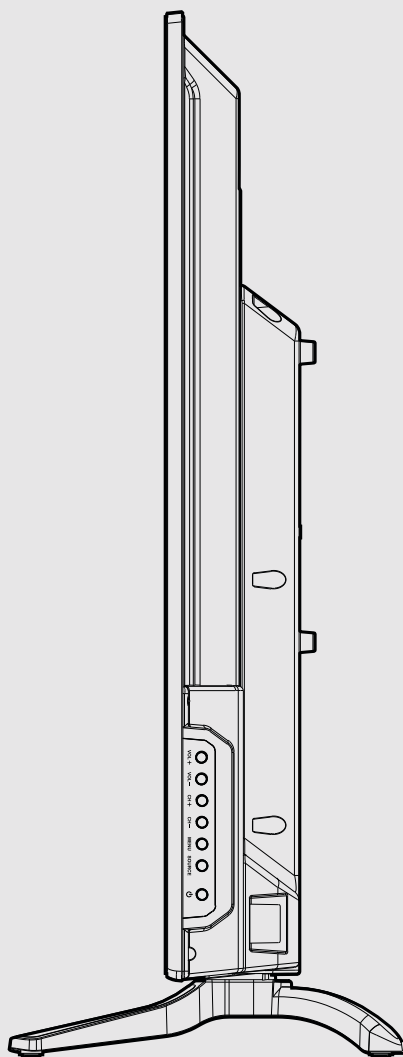

Operation using remote control

The remote control is designed to control all the functions of the model you selected.

Volume Setting

Press **VOL+** button to increase the volume. Press **VOL-** button to decrease the volume. A volume level scale (slider) will be displayed on the screen.

Programme Selection (Previous or Next Programme)

Press **CH-** button to select the previous programme. Press **CH+** button to select the next programme.

Programme Selection (Direct Access)

Press number buttons on the remote control to select programmes between 0 and 9. The TV will switch to the selected programme.

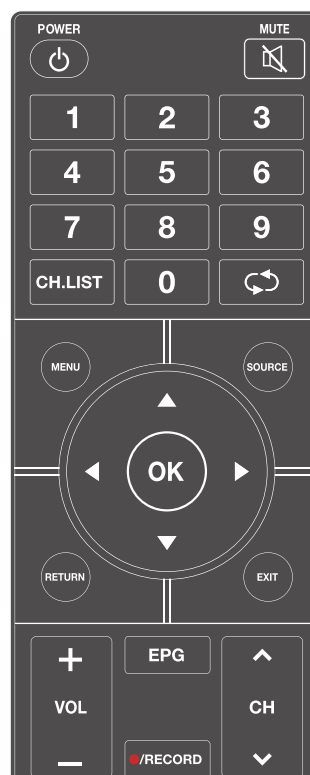

Connections

Left side connections explained

1. OPTICAL

To connect to the audio socket on the digital/standard 5.1 audio system.

2. COAXIAL

To connect to the audio socket on the digital/standard 5.1 audio system.

3. HDMI Input

Connects a device that has an HDMI socket. The TV can display High Definition pictures from devices such as a High Definition Satellite Receiver or DVD Player. These devices must be connected via the HDMI sockets or Component Socket. No sound connection is needed for an HDMI to HDMI connection.

4. MINI YPbPr

YPbPr input socket is just suitable for YPBPR MINI cable. Connect to a DVD player, Digital Set-Top-Box, or other AV devices with component YPBPR) video output sockets.

5. MINI AV

Need the adapter cables which are included. And M AV2 and MINI YPBPR share the same audio input (White, Yellow).

6. CI Slot

Used to insert a CI card. A CI card allows you to view all the channels that you subscribe to. For more information, see "Conditional Access" section.

7. HDMI Input

Connects a device that has an HDMI socket. The TV can display High Definition pictures from devices such as a High Definition Satellite Receiver or DVD Player. These devices must be connected via the HDMI sockets or Component Socket. No sound connection is needed for an HDMI to HDMI connection.

8. USB Input

To connect devices to the TV, providing fast data exchange. USB will have function in USB/DTV mode.

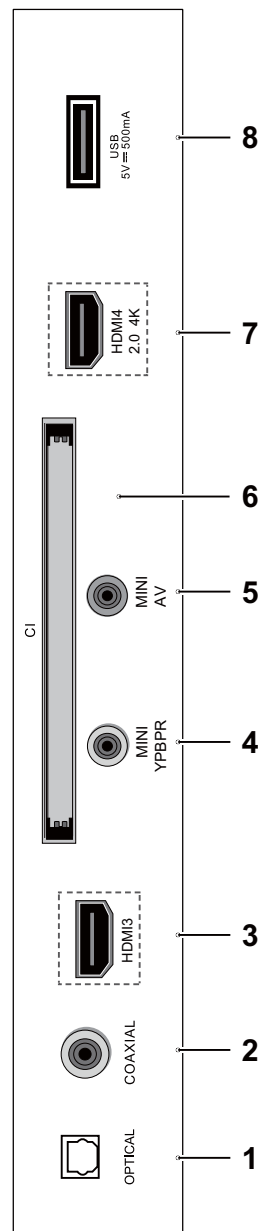
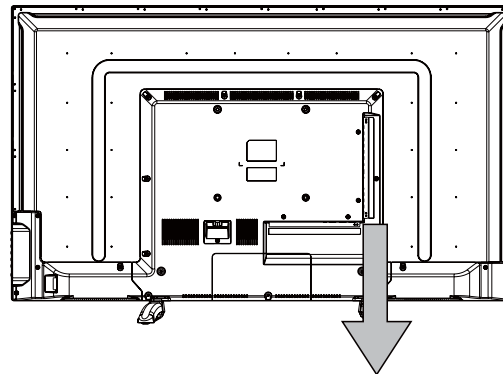

Connections

Left bottom connections explained

9. LAN

Network connection port.

10. HDMI Input

Connects a device that has an HDMI socket. The TV can display High Definition pictures from devices such as a High Definition Satellite Receiver or DVD Player. These devices must be connected via the HDMI sockets or Component Socket. No sound connection is needed for an HDMI to HDMI connection.

11. SCART socket

Inputs or outputs for external devices. Connect the SCART cable between the SCART socket on the TV and the SCART socket on the external device (decoder, VCR or DVD player).

Note: If an external device is connected via the SCART socket, the TV will automatically switch to SCART mode.

12. RF Input (ANT.)

Connects to aerial (antenna) or cable TV. If you use a decoder or a media recorder, you should connect the aerial cable through the device to the TV with an appropriate aerial cable.

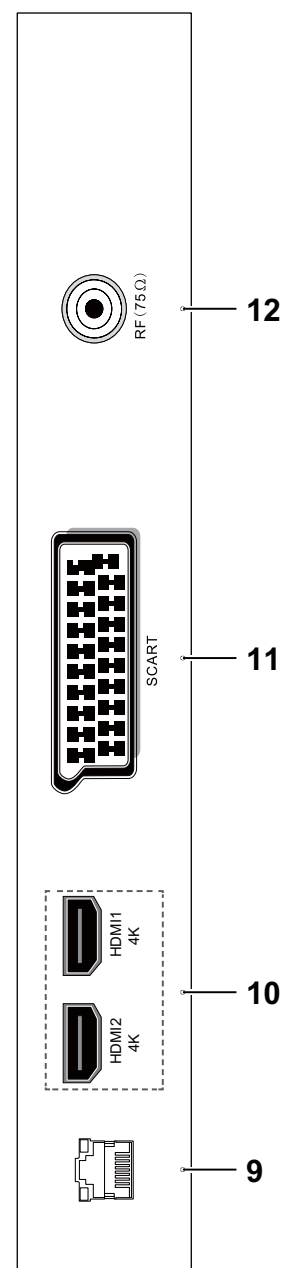
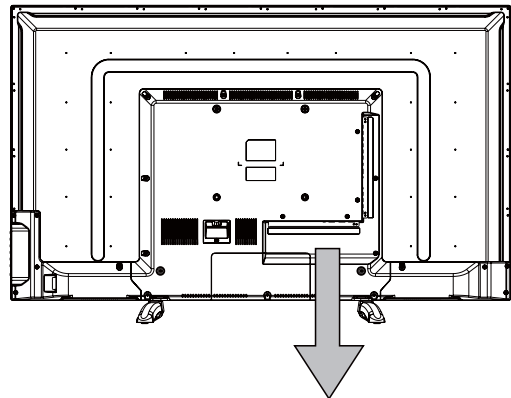

Connections

HDMI Connections

HDMI lets you enjoy high definition digital images and high quality sound by connecting the TV to external devices such as DVD players, set top boxes or gaming equipment.

Power off both the TV and the device before making any connections.

For more information, refer to your device's own instruction book.

When connecting, switch "Source" to "HDMI". See, "Input Selection" section.

Note: HDMI cable is not supplied.

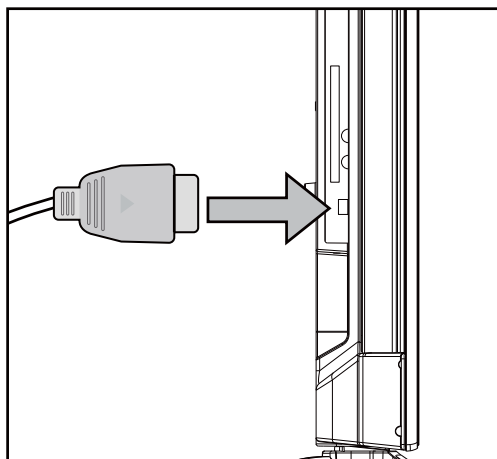

SCART Connections

Most devices support SCART connection. You can connect a DVD recorder, VCR or decoder to the TV using the SCART socket (fig.2).



Power off both the TV and the device before making any connections.

For more information, refer to your device's own instruction book.

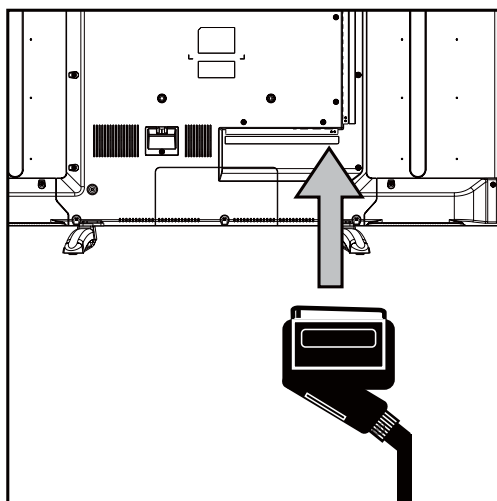
Note: The Scart cable is not supplied.



First time setup

1. Connect one end of an RF coaxial cable (not supplied) to the aerial socket in your wall. Connect the other end of the cable to the RF (75)socket in the bottom connection panel on the back of the TV.
2. Attach all other devices to the TV following the advice given in the instructions supplied with them.
3. Slot the plug on the TV's mains cable into a wall socket and turn the power on if required.
4. In standby mode, press the  button on the right side of the TV or press the  button on the remote control to turn the TV on. The red LED indicator on the front of the TV will turn blue.
5. After pressing the **OK** button you will go to the First Time Installation menu.

First Time Installation







Language	< English >
Country	< UK >
Tuning Mode	< DTV >
Environment	< Home Mode >
Auto Tuning	>

 Move

 Select

 Adjust

 Back

6. Language is preset to English and cannot be changed.
 7. Next press the  button on the remote control to select Country. Use the   buttons on the remote control to select the country you are tuning the TV in.
 8. Now press the  button on the remote control to select Tuning mode. Use the   buttons on the remote control to select either ATV + DTV (analogue and digital channels), DTV (digital channels only) or Analogue TV (analogue channels only).
 9. Press the  button on the remote control to select Environment. Use the   buttons on the remote control to select between Home Mode or Store Mode. If you select to change to store mode, a warning screen will appear asking if you do, press the  button to continue
- Note: Store Mode should only be used if the TV is to be used as a display in a shop.*
10. Once you have completed all of the preliminary settings press the  button on the remote control then the  button to begin Auto Tuning.

Channel Tuning

TV	:	0	Programme
DTV	:	0	Programme
Radio	:	0	Programme
Data	:	0	Programme

19%... UHF
CH 30
DTV



 Skip

 Exit

For any help concerning set up and use of your TV please call the **Customer Helpline: 0345 604 0105**

15

How to use your TV

SELECTING INPUT SOURCE

You can connect multiple devices to your TV to improve your watching and listening pleasure.

1. Press the **SOURCE** button on the TV or remote control to open the source menu.

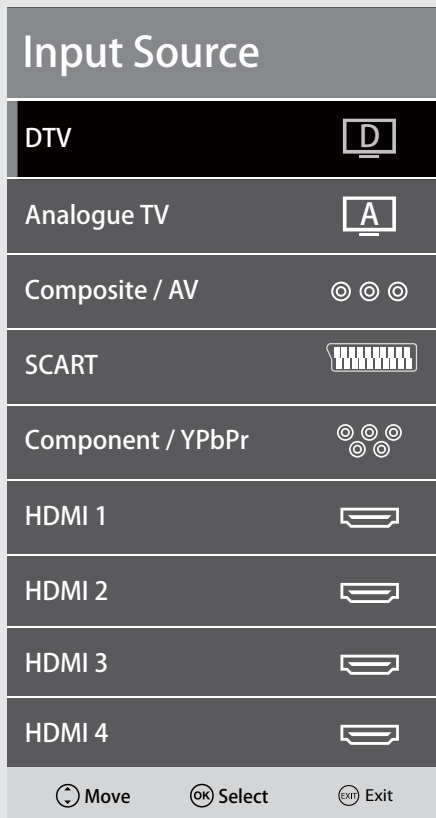

2. Use the **▲▼** buttons on the remote control to select the source you wish to watch or listen to.

Note: Not all sources will be displayed when the menu is open. You will need to use the **▲▼** buttons to scroll through the list to view all of the sources.

3. Press the **OK** button on the remote control to open the selected source.

USING THE ELECTRONIC PROGRAMME GUIDE (EPG)

Digital TV (DTV) channels only

Your TV has an Electronic Programme Guide (EPG) to help you navigate through all your possible viewing options.

The EPG supplies information such as programme listings, start and end times for all available services. In addition, detailed information about the programme is often available in EPG (the availability and amount of programme information will vary, depending on the particular broadcast). This function can only be used when the information is broadcast by the broadcasting companies.

The EPG displays the programme details for the next 7 days.

1. Press the **EPG** button on the remote control to open the Electronic Programme Guide window.



2. Use the **▲▼** buttons to select the station you wish to watch or listen to, then press the **OK** button to tune to that station. Press the **EPG** button again to close the Electronic Programme Guide window.

How to use your TV

3. You can also look through all of the programmes available over the next 7 days by pressing the ► button to enter the programmes listings. Use the ◀▶▲▼ buttons to scroll through the programmes, a brief description will be shown in the window near the top of the window.

At the bottom of the window there are additional feature buttons you can use. These are accessed using the coloured buttons on the top of the remote control.

RED button: Record.

Press this button to record programmes to a USB drive attached to the USB port on your TV, see page 39 for more information.

GREEN button: Prev.

Press the green button to scroll through the previous 7 days of programmes.

Note: *This only works if the broadcaster supports this function.*

YELLOW button: Next.

Press the yellow button to scroll through the next 7 days of programmes.

Note: *This only works if the broadcaster supports this function.*

BLUE button: Remind.

Press this button to open the **Reminder Setting** window.

To set the reminder, scroll to the programme you want to set the reminder for on the EPG menu using the ◀▶▲▼ buttons.

Press the **BLUE** button on the remote control to open the Reminder setting menu.

Adjust the settings of the menu using the ◀▶▲▼ buttons. When you have adjusted the menu, press the OK button to save the settings.

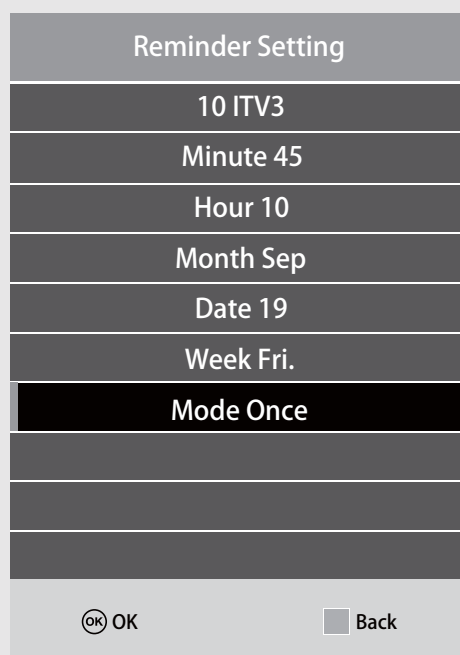

Press the **BLUE** button to go back to the EPG menu.

Your TV will now automatically turn itself on (if in standby mode) and tune to the programme when it starts.

How to use your TV

VIEWING TELETEXT

Digital TV (DTV) channels only

IMPORTANT: Before you can view Teletext you will need to turn the Subtitle function off if it is switched on.

Note: Before turning Teletext on, check that the TV channel you are watching transmits Teletext. If it does not, **NO Teletext** will be shown on the screen.

1. Press the **◀◀/TTX** button on the remote control to open the Teletext menu.



2. Follow the information on the Teletext page to access the page you want to view. You can also use the **0** to **9** buttons on the remote control to enter the page number you want to view.
3. You can also press the **RED** button on the remote control instead of the **◀◀/TTX** button when the red Teletext logo is shown on the TV screen.
4. Press the **◀◀/TTX** button again to close the Teletext menu.

How to select a page of text

1. Find the number of the page you wish to view and enter it in the search panel using the **0** to **9** buttons on the remote control then press the **OK** button.

2. The page counter will search for your page you wish to view. When the page is found it will automatically be displayed.
3. To move to the next or previous page use the **▲▼** buttons on the remote control.
4. To return to the index page, enter **100** into the search panel using the **0** to **9** buttons on the remote control and press the **OK** button or press the **INDEX** button.

How to use Fast Text

At the bottom of the Teletext page there is a row of subject headings coloured in Red, Green, Yellow and Blue.

To access these pages, simply press the correspondingly coloured button on the top of the remote control.

How to use your TV

USING THE TIME SHIFT FUNCTION

Digital (DTV) channels only

This function lets you quickly record the TV programme you are watching if you have to leave the room.

IMPORTANT: You must have a USB storage device attached to your TV to use the Time Shift function.

IMPORTANT: If the transfer rate of the attached USB storage device is too slow for the Time Shift function, a warning statement will be shown on the TV's screen. If this happens, please upgrade your USB storage device.

IMPORTANT: Time Shift mode may not work if the station's signal strength is too weak.

NOTE: Always stop the Time Shift function by pressing the ■ button before switching to another input source.

Using the Time Shift function

1. To start Time Shift, press the **TIMESHIFT** button on the remote control to pause the programme you are watching. The Time Shift symbol will be displayed in the top left of
2. When you wish to resume watching the programme, press the ►|| button on the remote control to show the PVR Time Shift progress bar.
3. Use the ◀▶ buttons to select the button on the progress bar then press the **OK** button to start watching the programme. ▶ will be displayed in the top left of the TV screen showing you are watching a programme in Time Shift.

4. Press the ■ button to stop the Time Shift recording and return to the live TV broadcast.

Alternatively: You can press the ● (red dot) button on the remote control to display the PVR Time Shift progress bar and then use the ◀▶ buttons to select ►|| on the bar then press the **OK** button to start playback.

Note: There may be a slight delay with the video and the sound may be slightly out of sync for a few seconds when you start watching the recorded programme. This will soon stop and the programme will play correctly.

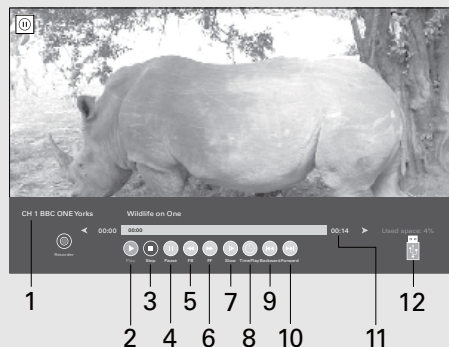

The Time Shift progress bar

Use the ◀▶ buttons to navigate through the progress bar. Once you have selected the feature you wish to use press the **OK** button.

1. Shows the channel and name of the recorded programme.
2. **PLAY:** Select to play your recording.
3. **STOP:** Select to stop play back.
4. **PAUSE:** Select to pause the recording.
5. **FB:** Select to rewind your recording at x2 / x4 / x8 / x16 / x32 speed.
6. **FF:** Select to fast forward the recording at x2 / x4 / x8 / x16 / x32 speed.

How to use your TV

- 7. Slow:** Select to view the recording in slow motion. Press the OK button multiple times choose between 2 / 4 / 8 / 16 / 32 playback speeds..
- 8. Time Play:** Select to enter a time you wish to view the recording from using the 0 to 9 buttons on the remote control.
- 9. Backward:** Select to move the recording backwards 30s of the recording.
- 10. Forward:** Select to move the recording forwards 30s of the recording.
- 11.** Shows the amount of playback time the recording has remaining.
- 12.** Shows the amount of memory remaining on your USB drive.

Using the remote control with Time Shift

You can use the buttons on the remote control to control playback in Time Shift.

- ▶|| Press to start and pause playback.
- ◀◀ Press repeatedly to rewind at x2 / x4 / x8 / x16 / x32 speed.
- ▶▶ Press repeatedly to fast forwards at x2 / x4 / x8 / x16 / x32 speed.

Important: To return to normal playback press the ▶|| button.

- ◀◀ Press to jump backwards approximately 30s of the recording time.
- ▶▶ Press to jump forwards approximately 30s of the recording time.
- Press to stop the Time Shift recording.

RECORDING DTV PROGRAMMES

Digital (DTV) channels only

You can record digital TV programs onto a USB drive using either direct recording by pressing the red dot button or using the program timer function.

IMPORTANT: You must have a USB storage device attached to your TV to use the recording function.

IMPORTANT: If the transfer rate of the attached USB storage device is too slow for the recording function, a warning statement will be shown on the TV's screen. If this happens, please upgrade your USB storage device.

IMPORTANT: Recording mode may not work if the stations signal strength is too weak.

Instant recording

This option is used to record the program you are watching.

1. Press ● record button on the remote control to record the programme you are currently watching.

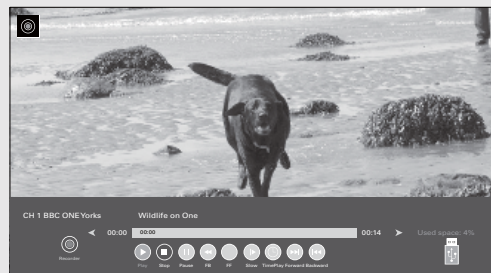

The recording progress bar will be displayed, press the EXIT button to close recording progress bar. The recording symbol in the top left of the screen will still be visible showing that the TV is still recording. If you want to view the recording progress bar again, press the ● button on the remote control.

How to use your TV

- When the programme has finished and you want to stop the recording, simply press the **■** button.

USING THE PROGRAMME TIMER

Digital TV (DTV) channels only

The programme timer is used to schedule program recordings.

Note: There may be a small delay when the program starts recording. Always ensure a USB drive is inserted into the USB slot in the back of the TV. If not, a warning message will appear on the TV screen.

Using the programme timer

- Press the **EPG** button on the remote control to open the Electronic Programme Guide menu.

PROGRAMME GUIDE			
19 Aug 2014 12:00 - 12:30 (0Hours30Min)			
2/6. Houses and Palaces: Steeplejack Fred Dibnah tours Britain's engineering marvels. Here, he visits Hampton Court Palace and one of the first homes to have electric lighting - Cragside. [S]			
19 Aug 2014	12: 29		19 Aug 2014
1	BBC ONEYork	05:32 - 12:00	This is BBC FOUR
2	BBCTWO	12:00 - 18:58	This is BBC FOUR
3	ITV	18:58 - 19:00	This is BBC FOUR
4	Channel 4	19:00 - 20:00	Sacred Music
5	Channel 5	20:00 - 21:00	Walter Tull: Forgotten Hero
6	ITV2	21:00 - 22:00	Walter's War
7	BBCTHREE	22:00 - 23:00	Quincy Jones: The Many Lives of Q
9	BBC FOUR	23:00 - 00:00	Quincy Jones: The Many Lives of Q

- Use the **▶** button then the **▲▼** buttons to select the programme you want to record then press the **RED** button to open the Record menu.

Recorder
10 ITV3
Start Time
Minute 0
Hour 10
Month Sep
Date 21
End Time
Minute 0
Hour 11
Month Sep
Date 21
< - Mode Once + >
OK Back

- Use the **◀▶▲▼** buttons to change the settings in the menu if you need to.

Channel: Use the **◀▶** buttons to select the channel you want to record.

Start Time: Use the **▲▼** buttons to select either Minute / Hour / Month / Date. Use the **◀▶** buttons to adjust the settings.

End Time: Use the **▲▼** buttons to select either Minute / Hour / Month / Date. Use the **◀▶** buttons to adjust the settings.

Mode: Use the **◀▶** buttons to select either Once / Every Day / Weekly.

- After making all of your adjustments press the **OK** but your settings. The Timer was saved Successfully screen will appear.

How to use your TV



Timer was saved Successfully

(2014) 08/19 19:30

E4+1

5. The Schedule List will now appear at the bottom of the screen showing all of your scheduled recordings.

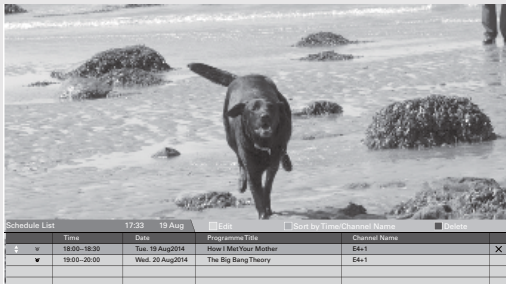

6. You can use the colour buttons on the top of the remote control to change, organise and delete items in the schedule list. Press the **EXIT** button to close the menus.

Note: When the preset time is reached the TV will start recording automatically. If the recording starts when the TV is in standby mode the LED indicator on the front of the TV will flash blue.

How to use your TV

WATCHING RECORDED PROGRAMMES

You can play a recorded programme from the recorded programme list on from the USB storage device.

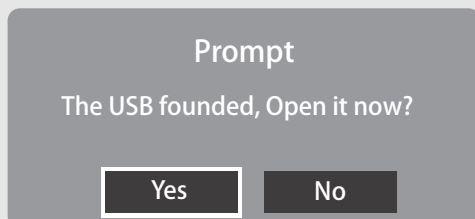

Note: When a USB storage device is inserted into one of the USB ports in your TV a message will be displayed when you turn your TV on or when you insert the device asking if you want to go directly to the MultiMedia menu. Use the ◀▶ buttons to select either Yes or No and press the OK button to confirm.

1. To open the MultiMedia menu whilst using the TV, press the **MENU** button on the remote control or on bottom of the TV. Use the ◀▶▲▼ buttons to select the **MultiMedia** menu and press the **OK** button to confirm.

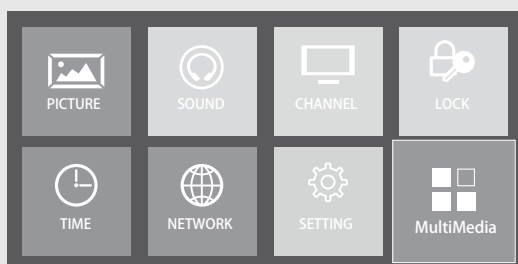

2. Press the **OK** button to select **MOVIE**, then use the ◀▶ buttons to select your USB storage device. Finally press the **OK** button to open the movie menu.

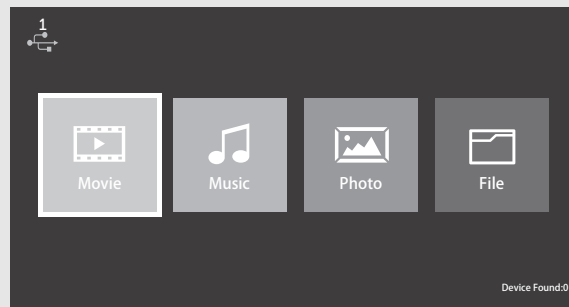

3. Use the ▲▼◀▶ buttons to select **_MSTPVR** OK button to open.

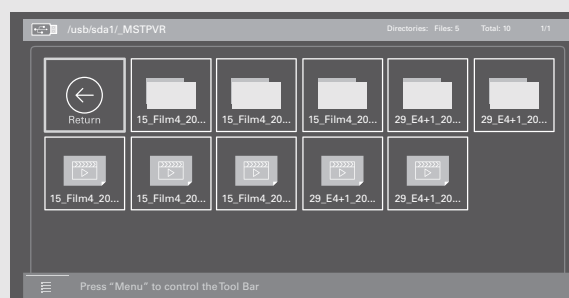

4. Use the ▲▼◀▶ buttons to select the recorded programme you wish to watch.

Note: When you highlight a film to watch, after a few seconds a few seconds a thumbnail movie will appear on the screen.

5. If you have a lot of movies stored in the file you can press the **MENU** button to open the tool bar. This will help when looking through the files in your **_MSTPVR** folder.
6. When you have found film you want to watch, press the **OK** or ▶|| button to play the recording in full screen mode.
7. Press the **MENU** button to display the function bar at the bottom of the screen. Use the ◀▶ buttons to navigate through the functions then press the **OK** when you have highlighted the one you require. See over the page for a full list of the function bars list of functions.

How to use your TV



List of functions

Play: Press to play the programme.

Previous: Press to watch the previous programme in the playlist.

Next: Press to watch the next programme in the play list.

Pause: Press to pause the programme.

Stop: Press to play back of the programme.

FB: Press repeatedly to rewind at x2 / x4 / x8 / x16 / x32 speeds.

FF: Press repeatedly to fast forwards at x2 / x4 / x8 / x16 / x32 speeds.

Repeat: Press to select the repeat function you want. Choose form NONE / ONE / ALL / RANDOM.

TimePlay: Allows you to select a time to start watching the programme from.

Enlarge: Allows you to enlarge the screen image programme. Use the

▲ ▼ ◀ ▶ buttons to move around the enlarged image.

Shrink: Allows you to shrink the screen image of the programme.

Playlist: Shows you a full list of films you can watch. Press the **EXIT** button to close the submenu.

Info: Shows information about the programme you are watching. Press the **EXIT** button to close the submenu.

8. Press the **EXIT** button to return to the previous menus.

TV systems management

PICTURE MENU

This menu allows you to select the best preset picture mode or change them yourself.

Note: The menu shown in the diagram has been extended to show all available options. You will need to use the ▲▼ buttons to scroll through the menu to view all of the options.

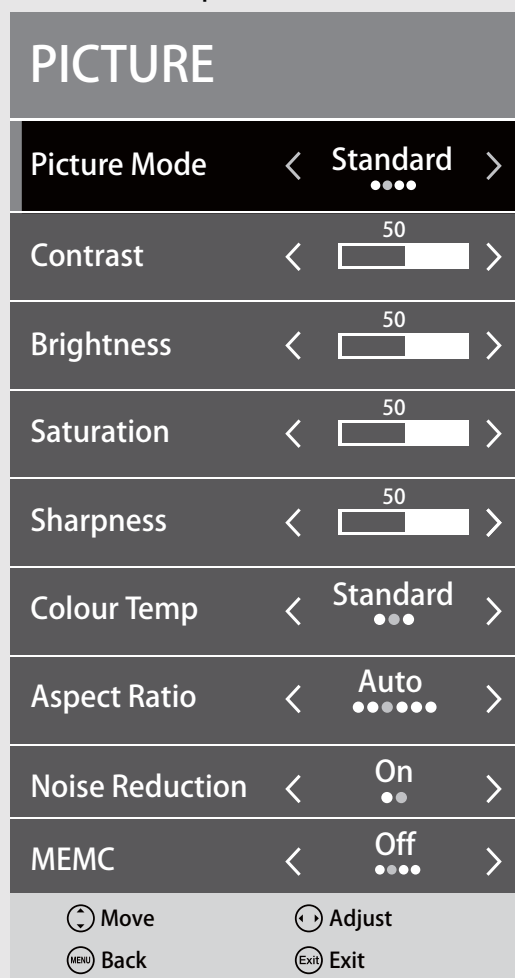

1. Press the **MENU** button on the remote control.
2. Use the ▲▼◀▶ buttons to select the **PICTURE** menu then press the **OK** button to open.
3. Use the ▲▼ buttons to navigate through the menu to select the item you wish to change.

4. Use the ◀▶ buttons to change the selected sub menu.
5. Press the **MENU** button on the remote control to return to the main **PICTURE** menu.
6. After you have made all of the changes, press the **EXIT** button on the remote control to close the **PICTURE** menu.

What the sub menus do

Picture Mode: Choose between Dynamic / Standard / Mild / Personal modes.

Contrast: Adjusts the difference between light and dark levels in the picture.

Brightness: Increases or decreases the amount of white in the picture.

Saturation: Control the intensity of the colour.

Sharpness: Adjust the level of crispness in the edges between light and dark areas of the picture.

Colour Temp: Choose between Standard / Warm / Cool. The colour temp changes the amount of blue and red in your picture.

Aspect Ratio: Choose to view the TV picture in various formats. Choose from AUTO / 4:3 / 16:9 / Zoom 1 / Zoom 2.

Noise Reduction: Choose between On or Off. Noise reduction reduces the amount of picture noise (speckles and lines etc.) of any connected device.

MEMC: Cycle among Motion Estimate and Motion Compensation modes: Off/Low/Middle/High.

TV systems management

SOUND MENU

This menu allows you to select the best preset sound mode or change them yourself.

Note: The menu shown in the diagram has been extended to show all available options. You will need to use the ▲▼ buttons to scroll through the menu to view all of the options.

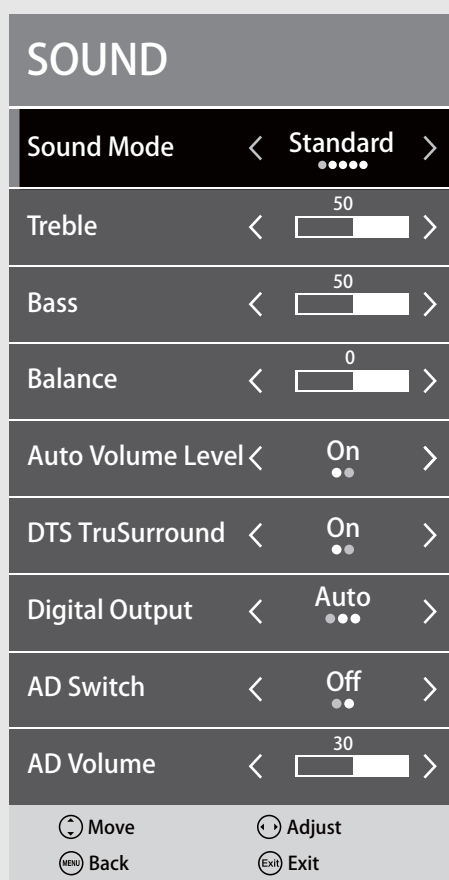

1. Press the **MENU** button on the remote control.
2. Use the ▲▼◀▶ buttons to select the **SOUND** menu then press the **OK** button to open.
3. Use the ▲▼ buttons to navigate through the menu to select the item you wish to change.

4. Use the ◀▶ buttons to change the selected sub menu.
5. Press the **MENU** button on the remote control to return to the main **SOUND** menu.

What the sub menus do

Sound Mode: Choose between Standard / Music / Movie / Sport / Personal modes.

Treble: Use to adjust the amount of treble in the TV's sound.

Bass: Use to adjust the amount of bass in the TV's sound.

Balance: Use to adjust the relative volume of the speakers in a multiple speaker system.

Auto Volume Level: Turn on to automatically adjust volume levels (e.g. volume levels in adverts are generally louder than programmes).

DTS TruSurround

Switches the virtual surround sound feature on or off.

Digital Output: Use when a digital audio connection is attached to your TV. Select between PCM / Auto / Off.

AD Switch: Audio Description is an auxiliary audio function that provides an additional audio track for visually impaired people. This function handles the Audio Stream for the AD (*Audio Description*) when it is sent along with the main audio from the broadcaster. Use the ◀▶ buttons to choose between On or Off.

Set to Off: You will receive normal broadcast sound from the TV's speakers.

Set to On: You will receive the additional Audio Description sound channel if available.

TV systems management

AD Volume: Use the **AD** button to set the volume of the audio description.

Note: If you want to change the sound mode, repeatedly press **S.MODE** button on the remote control until you find the one you want.

CHANNEL MENU

This menu allows you to retune, edit your channel list, check your signal information, check your recorded and schedule lists and update your TV's software using the over air download system.

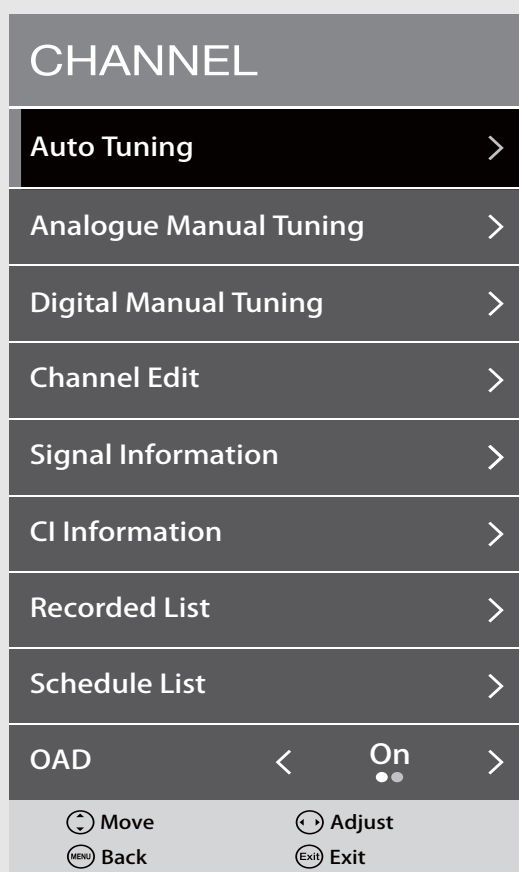

Note: The menu shown in the diagram has been extended to show all available options. You will need to use the **▲▼** buttons to scroll through the menu to view all of the options.

1. Press the **MENU** button on the remote control.
2. Use the **▲▼◀▶** buttons to select the **CHANNEL** menu then press the **OK** button to open.

3. Use the **▲▼** buttons to navigate through the menu to select the item you wish to change.
4. After you have made all of the changes, press the **EXIT** button on the remote control to close the **CHANNEL** menu.

Auto Tuning

1. Select the Auto Tuning submenu and press the **OK** button to open it.

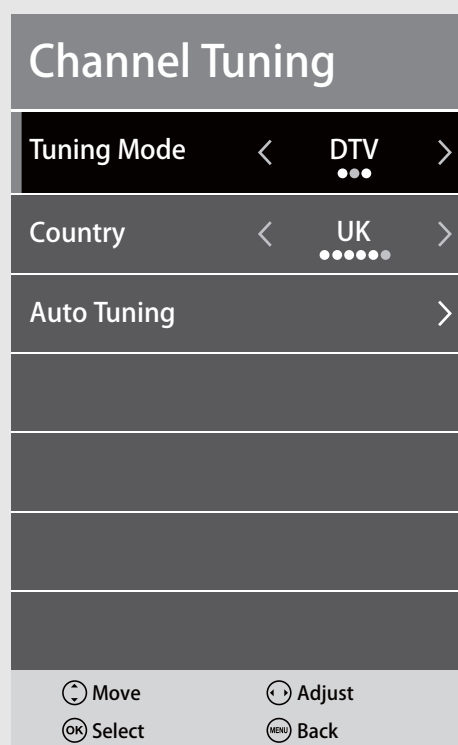

2. Select the tuning type using the **◀▶** buttons, you can choose between DTV + ATV / DTV / Analogue TV.

Press the **▼** button and choose the country you are tuning the TV in using the **◀▶** buttons.

3. Press the **▼** button and select Auto Tuning and press the **▶** or **OK** button to start the tuning process.
4. Once the tuning has finished you can set the Country, Region and Secondary Region using the **▲▼** buttons, confirm your selections by pressing the **OK** button. Once you have completed all of the settings the menu will close automatically.

TV systems management

Analogue Manual Tuning

IMPORTANT: This feature is not available in the UK as analogue signals are no longer broadcast.

1. Press the ▼ button to select Analogue Manual Tuning and press **OK** on the remote control.

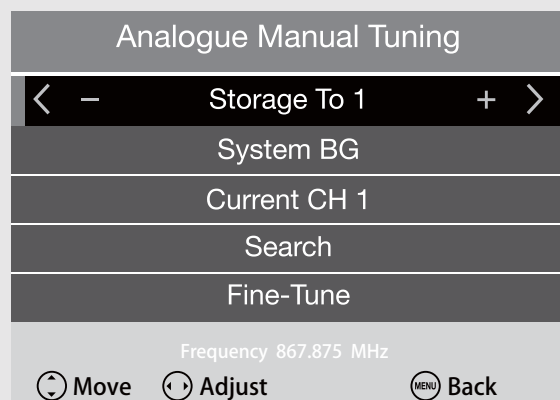

2. The Analogue Manual Tuning menu will now open.
3. Select the storage location of the channel using the ◀▶ buttons.
4. Press the ▼ button to select SYSTEM, then press the ◀▶ buttons to choose between I / DK / L / M / BG.
5. Press the ▼ button to select SEARCH then press the ▶ button to search through the different frequencies until you find the program you want.
6. After the search, press the ▼ button to select FINE-TUNE you can now do small adjustment to improve the signal using the ◀▶ buttons.
7. Press the MENU button on the remote control to save the channel.

IMPORTANT: If the number about to save is the same as a channel that is already being used, the manually adjusted channel will replace the existing channel.

Digital Manual Tuning

1. Use the ▼ button to select Digital

Manual Tuning and press **OK** on the remote control to open the submenu.

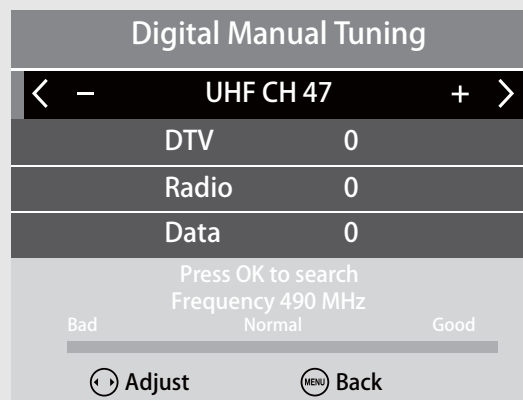

2. The Digital Manual Tuning menu will now open.
3. Press the ◀▶ buttons to select the desired UHF channel.
4. Press the **OK** button and the search for available stations on that channel will begin.
5. Once the signal has been tuned the signal strength will be displayed on the screen.
6. The menu will close and the tuned channel will be shown on your TV screen.

TV systems management

Channel Edit

Allows you to edit TV channel information in the Channel List.

1. Press the **MENU** button to open the **CHANNEL** menu.



2. Press the **▼** button to select Programme Edit and press the **OK** button on the remote control to open the submenu.

Delete: Highlight the channel you want to delete using the **▲▼** buttons. Press the **RED** button on the top of the remote control to delete the programme from the **EPG** menu.

Move: Use the **▲▼** buttons to highlight the channel you want to move in the **EPG** menu and press the **YELLOW** button on the remote control. Move the channel to the position you want it in and press the yellow button again.

Skip: Use the **▲▼** buttons to highlight the channel you want to skip in the **EPG** menu and press the **BLUE** button on the remote control.

Fav: Select the channels you want to add to your favourites list using the **▲▼** buttons then press the **FAV** button on the remote control to confirm.

Signal Information

Allows you to view the signal strength of the selected channel TV signals.

Use the **▼** button to select Signal Information from the menu then press the **OK** button. To close the submenu, press the **MENU** button.

CI (Common Interface)

Digital TV channels only

This function allows you to view the common interface module information.

1. Use the **▼** button to select CI Information from the menu then press the **►** button to open the submenu.
2. The Common Interface main menu will now open. Press the **▲▼** buttons to select the items and press the **OK** button to confirm.
3. Press the **EXIT** button to close the menu.

The common interface allows the use of a Common Access Module to enable you to unscramble (*pay to view*) services. These services are provided by other service providers than free to view TV channels.

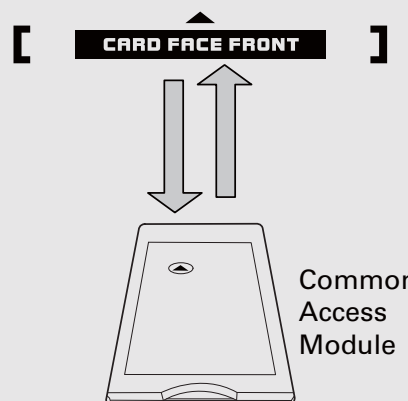

Important: Do not keep removing and reinserting the Common Access Module as it could damage the interface and cause a malfunction.

TV systems management

Fitting the Common Access Module

Note: This feature is not available in all countries.

1. Before you inset the Common Access Module (CAM) into the CI slot in the side of the TV, ensure the TV is switched off at the mains and the viewing card has been correctly inserted into the CAM in accordance with the service providers instructions.
2. Insert the Common Access Module into the slot in the side of the TV. If you feel resistance when inserting the CAM, turn it over and try again.
3. Turn the TV back on at the mains and switch on. You will now be able to access the encrypted channels from the service provider.

Removing the Common Access Module

1. Before removing the CAM ensure the TV is switched off at the mains.
2. Pull the CAM out of the CI slot in the side of the TV.
3. Switch the TV back on at the mains.

Recorded List

Use the ▼ button to select Recorded List from the menu and press the **OK** button to open the menu.

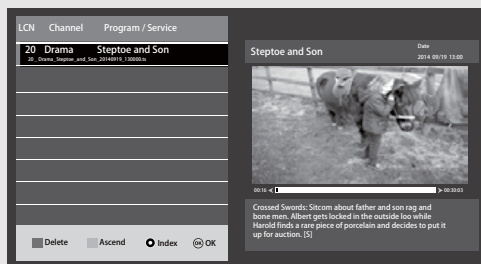

You can now see a full list of all of the programmes recorded on your USB drive.

You can interact with the list using the coloured buttons on the top of your remote control.

Note: If there is no USB storage device fitted to the TV a warning message **No USB Detected** will be show, press the **EXIT** button on the remote control to close the Recorded List menu.

Scheduled List

Use the ▼ button to select Scheduled List from the menu and press the **OK** button to open the menu.

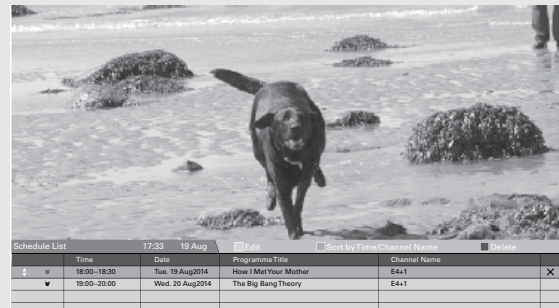

You can now see a full list of all of the programmes you have scheduled. You can interact with the list using the coloured buttons on the top of your remote control.

If there is no USB storage device fitted to the TV a warning message **No USB Detected** will be shown, press the **EXIT** button on the remote control to close the Recorded List menu.

OAD (Software Update)

(Over Air Download)

Digital TV (DTV) channels only

The TV auto detects the latest firmware update through the DTV signal and allows you to accept or refuse the firmware upgrade service.

1. Press the MENU button on the remote control, use the ► button to select the CHANNEL menu.

TV systems management

2. Use the ▲▼ buttons to select Software Update (OAD). Press the **OK** button to select either On or Off.
3. Press the **MENU** button to return to the main menu.
4. Press the **EXIT** button to exit the menu.
5. During normal DTV viewing, if the TV detects an update to the firmware from the DTV signal, the Over Air Download screen will appear. Use the ◀▶ buttons to select either **Yes** or **No**.

Note: If you do not press any button within 1 minute, the Over Air Download screen will disappear. The Over Air Download screen will appear next time you switch to viewing a DTV channel.

LOCK MENU

Lock System

You will have to enter your password or the default password is **0000** before you can change any of the settings in the lock menu.

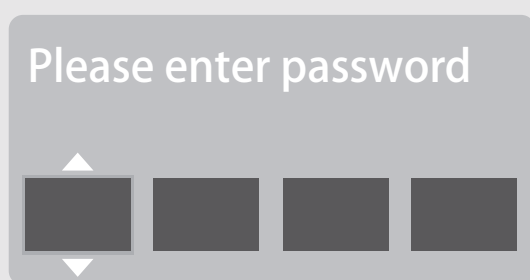

1. Press the **MENU** button on the remote control.
2. Press the ▲▼◀▶ buttons to select the **LOCK** menu.
3. Use the ▲▼ buttons to navigate through the menu and press the **OK** button to select the item you wish to change.

4. The main **SETUP** menu may close and the selected items sub menu may appear. Use the ▲▼◀▶ and **OK** buttons to change the settings.
5. Press the **MENU** button on the remote control to return to the **LOCK** menu.
6. After you have made all of the changes, press the **EXIT** button on the remote control to close the **LOCK** menu.

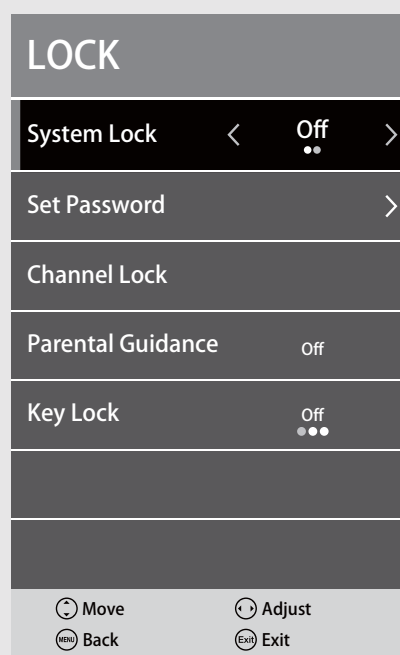

Set Password

Use the ▼ button to select Set Password then press the **OK** button. Use the **0** to **9** buttons on the remote control to enter your password or the default **0000** password.

Press the ▼ button and enter your new password using the **0** to **9** buttons. Press the ▼ button and enter your new password again using the **0** to **9** buttons.

Your new password has now been saved and the submenu will close.

TV systems management

Note: 0000 is the master password and can always be used.

Block Program

Use the ▼ button to select Block Program then press the **OK** button. Scroll through the list of available channels using the ▲▼ buttons.

When you have highlighted the channel you wish to lock press the **GREEN** button on the top of the remote control.

Note: The locked channels will no longer appear in the EPG menu.

Parental Guidance

Use the ▼ button to select Parental Guidance then press the **OK** button. Parental guidance is used to set an age rating for programmes on the TV before the password is required to watch the program.

Scroll through the list of available ages using the ▲▼ buttons.

Choose the age rating you want and press the **OK** button to confirm.

Key lock

Use to lock the remote control, you must enter the password before the remote control will function.

Turn key lock on and off by pressing the **OK** button.

TIME MENU

1. Press the **MENU** button on the remote control.
2. Press the ► button to select the **TIME** menu.
3. Use the ▲▼ buttons to navigate through the menu and press the **OK** button to select or change the item.
4. The main **TIME** menu may close and the selected items sub menu may appear. Use the ▲▼◀▶ and **NOK** buttons to change the settings.

5. Press the **MENU** button on the remote control to return to the **TIME** menu.
6. After you have made all of the changes, press the **EXIT** button on the remote control to close the **TIME** menu.

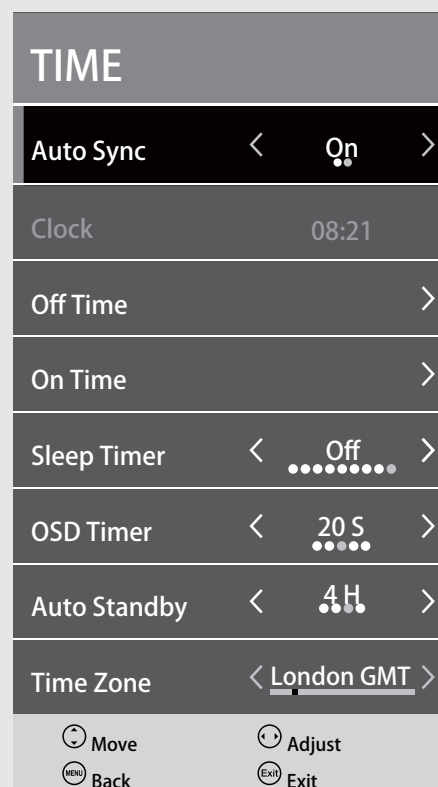

Auto Sync

When Auto Sync is switched on the TV will take the time from signals received by the TV through the broadcast signals.

Use the ◀▶ buttons to switch the Auto Sync On or Off.

Clock

You can only use the clock feature if Auto Sync is set to Off.

Highlight Clock using the ▲▼ buttons then press the **OK** button. You will now enter the Clock submenu.

Use the ▲▼ buttons to navigate through the menu.

TV systems management

Set the Year / Month / Day / Minute using the ◀▶ buttons then press the

OK button confirm and return to the main menu.

Off Time

This feature will automatically turn then the TV off at a specified time and on specified days.

Use the ▼ button to select Off Time then press the **OK** button, the sub menu will now open.

Use the ◀▶ buttons to choose between Off / Once / Everyday / Mon.~Fri. / Mon.~Sat. / Sat.~Sun./ Sun.

Press ▼ the button and set the hour using the ◀▶ buttons.

Press ▼ the button and set the minutes using the ◀▶ buttons.

After you have finished setting the Off Time,press the **MENU** button to return to the **TIME** menu.

On Time

This feature will automatically turn the TV on at a specified time.

Use the ▼ button to select On Time then press the **OK** button, the sub menu will now open.

Use the ◀▶ buttons to choose between Off / Once / Everyday / Mon.~Fri. / Mon.~Sat. / Sat.~Sun. / Sun.

Press ▼ the button and set the hour using the ◀▶ buttons.

Press ▼ the button and set the minutes using the ◀▶ buttons.

Press ▼ the button and select the input source using the ◀▶ buttons. Choose between DTV / Analogue TV / Radio / Data / SCART / Component / YPbPr / HDMI 1 / HDMI 2 / HDMI 3 / HDMI4 / Composite /AV.Press ▼ the button and select a channel for TV or Radio using the▼ buttons. Press ▼ the button and

set the volume using the ◀▶ buttons.

After you have finished setting the On Time press the **MENU** button to return to the main **TIME** menu.

Sleep Timer

This feature will automatically turn the TV into sleep mode after a set time if no control buttons are pressed.

Use the ▲▼ buttons to choose between Off /10/20/30/60/90/120/180/240 minues.

After you have finished setting the sleep timer, press the **MENU** button to return to the main **TIME** menu.

OSD Timer

This feature how long the On Screen Display will be shown for.

Use the ▲▼ buttons to choose between off / 5 / 15 / 30 / 60 seconds.

After you have nished setting the sleep timer, press the **MENU** button to return to the main **TIME** menu.

Auto Standby

This feature will automatically turn the TV off and into standby mode if no control or button is pressed. Choose from Off / 3 Hours / 4 Hours / 5 Hours using the ▲▼ buttons.

After you have finished setting the Auto Standby, press the **MENU** button to return to the main **TIME** menu.

Time zone

This feature can only be used if Auto Sync is set to On. Use to set the time zone the TV is being used in.

Use the ▼ button to select Time Zone then press the **OK** button.

The Time zone submenu will now open. Use the ▲▼◀▶ buttons to select the local time zone then press the **OK** button.

TV systems management

Network

Use the ▼ button to select Network then press the OK button.

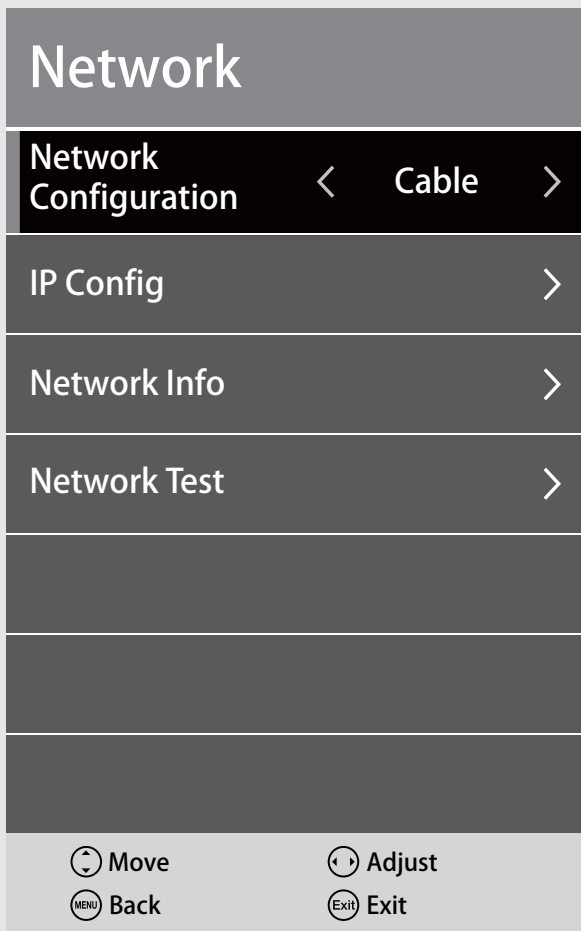

Network Configuration

This is preset to cable and cannot be changed.

IP Config

Press ▲ or OK button to enter the sub menu and select either Auto or manual setup using the ◀▶ buttons.

Network Info

Press either the ► button or the **OK** button to view all the relevant information concerning your network setup.

Network test

Press either the ► button or the **OK** button to open the submenu. Once the menu is open you can check if your network is working.

SETTING MENU

Note: The menu shown in the diagram has been extended to show all available options. You will need to use the ▲▼ buttons to scroll through the menu to view all of the options.

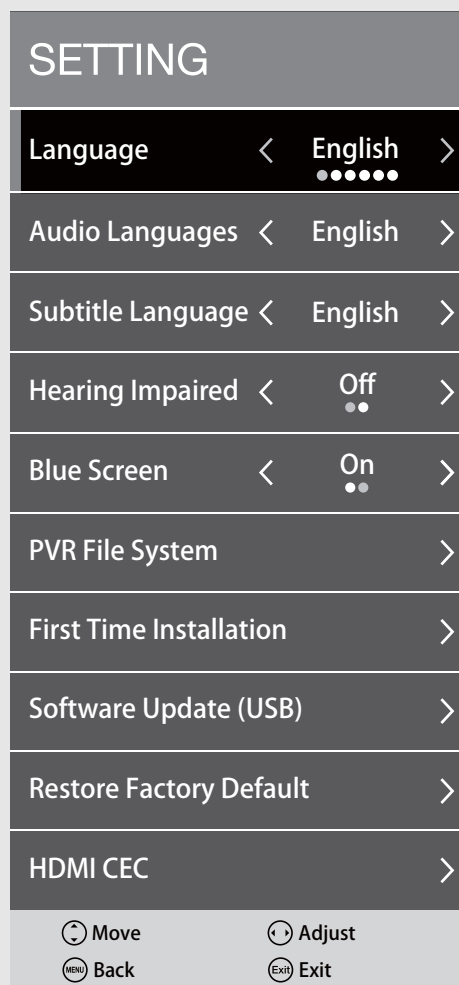

TV systems management

1. Press the **MENU** button on the remote control.
2. Press the **▲▼◀▶** buttons to select the **SETTING** menu then press the **OK** button.
3. Use the **▲▼** buttons to navigate through the menu and press the **OK** button to select the item you wish to change.
4. The main **SETUP** menu may close and the selected items sub menu may appear. Use the **▲▼◀▶** and **OK** buttons to change the settings.
5. Press the **MENU** button on the remote control to return to the **SETTING** menu.
6. After you have made all of the changes, press the **EXIT** button on the remote control to close the **SETTING** menu.

Language

The on screen display language is set to English and can be changed.

Audio Language

Audio Language is the language certain items are played in, depending on availability.

Press the **▼** button to select the Audio Language. Press the **OK** button to the sub menu, then use the **◀▶** buttons to select either Primary or Secondary then press the **◀▶** button.

Select your preferred language from the selection using the **▲▼◀▶** buttons, press the **OK** button to confirm. Press the **MENU** button to return to the **SETTING** menu.

Subtitle Language

Subtitle Language is the language certain items are played in, depending on availability.

Press the **▼** button to select the Audio Language. Use the **◀▶** buttons to select either Primary or Secondary then press the **▼** button.

Select your preferred language from the selection using the **▲▼◀▶** buttons, press the **OK** button to confirm. Press the **MENU** button to return to the **SETTING** menu.

Hearing Impaired

Shows additional information for people with impaired hearing when switched on (*if supported by the broadcaster*). Use the **▼** button to select Hearing Impaired then use the **OK** button to switch On or Off.

Blue Screen

Blue screen is used when there is no signal or during a weak signal.

Use the **▼** button to select Blue Screen then use the **OK** button to switch On or Off.

PVR File System

Use the **▼** button to select PVR File System then press the **OK** button to open the PVR File System submenu.

Select Disk: Lets you select the USB drive you wish to check using the **◀▶** buttons. You can then select which disk to check using the **◀▶** buttons.

Timeshift Size: This lets you choose the amount of memory the Timeshift function can use on a connected USB device. Choose between 512MB / 1GB / 2GB / 4GB using the **◀▶** buttons.

TV systems management

Format Start: Use this to reformat the USB drive, press the OK button to start.

IMPORTANT: If you reformat the USB drive you will lose all of the data on it. Always backup the drive before reformatting it.

Speed Check: Use this feature to check the speed of your USB drive by pressing the OK button.

First Time Installation

Use the ▼ button to select First Time Installation then press the **OK** button.

This will now re scan all available TV and radio channels, see pages 17 and 18 for more information.

Software Update (USB)

Insert the USB drive with the update on it into one of the USB ports on your TV then turn your TV on by pressing the power button. Follow the on screen information to update your TV.

Restore Factory Default

Use the ▼ button to select Restore Factory Default then press the OK button.

A warning window will open asking 'Are you sure', if you wish to reset the TV to the factory settings press the ◀ button. If you do not want to reset the TV press the ▶ button.





HDMI CEC

Turn on Consumer Electronics Control (CEC) so that you can control up-to 15 CEC-enabled devices that are connected through HDMI directly from one remote control.

Please note: CEC also allows for individual CEC-enabled devices to command and control each other without your intervention.

Entertainment Features

USING THE USB FEATURES

1. Always switch the TV off before attaching a USB storage device to your TV.
2. Connect the USB storage device to one of the USB ports on your TV.
3. Press the  button on the remote control or TV to turn the TV on.
4. Press the **Menu** button on your remote control. Use the     buttons to select **MultiMedia** from menu then press the **OK** button to open.

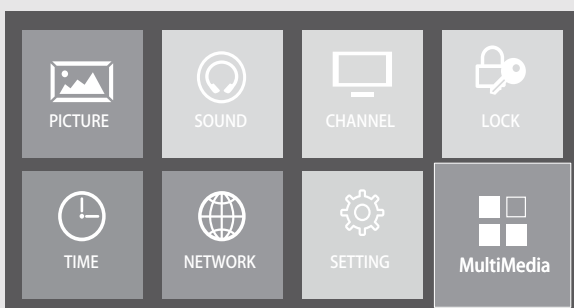

IMPORTANT: Some portable USB hard disks may require more power than the TV's USB port can supply. To ensure the correct operation of the USB hard disk please use an appropriate power adapter with the hard disk.

If you are using a USB Hub, please ensure its mains adapter is connected to the mains supply as the total current consumption may exceed 500mA, the maximum the TV can supply.

The maximum supported storage space the TV can read is 1TB.

The file system only supports FAT32 format.

If you want to keep recorded DTV programmes the transfer rate of the storage device must not be less than 5MB/s, otherwise the picture and sound of the programme will be affected and a warning statement will be shown on the TV's screen. If this happens please upgrade your USB storage device.

Your TV screen will go temporarily blank when you start recording as it takes a few seconds to stabilize the connection to the USB storage device.

Always disconnect the USB storage device if it is not going to be used for extended periods.

Entertainment Features

Viewing Movies:

Use the ◀▶ buttons to select **Movie** folder then press the **OK** button.

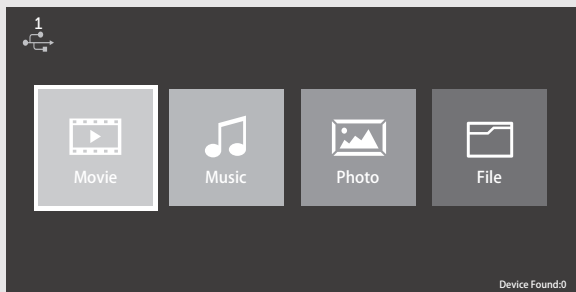

Use the ◀▶ buttons to select the USB device you want to look in (if more than one device is connected to your TV) then press the **OK** button.

Use the ▲▼◀▶ buttons to navigate to the **Folder or file** and press the **OK** button to open.

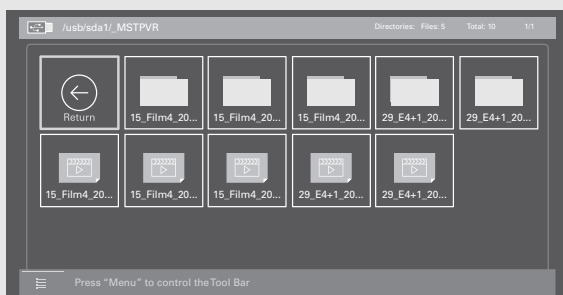

Use the ▲▼◀▶ buttons find the movie you watch press the **OK** or ▶|| button to begin watch it in full screen.

Note: If you want to delete the movie press the **RED** button on the remote control.

If you want to copy the movie press the **BLUE** button on the remote control once to copy and again to paste.

If you press the menu button on the remote control when the movie is playing the Movie Function Bar will be displayed.

Use the ◀▶ buttons to select the different functions available on the function bar, press the **OK** button to select the function.

List of functions



Play: Press to play the programme.

Previous: Press to watch the previous programme in the playlist.

Next: Press to watch the next programme in the play list.

Pause: Press to pause the programme.

Stop: Press to play back of the programme.

FB: Press repeatedly to rewind at x2 / x4 / x8 / x16 / x32 speeds.

FF: Press repeatedly to fast forwards at x2 / x4 / x8 / x16 / x32 speeds.

Repeat: Press to select the repeat function you want. Choose form NONE / ONE / ALL / RANDOM.

TimePlay: Allows you to select a time to start watching the programme from.

Enlarge: Allows you to enlarge the screen image programme.

Shrink: Allows you to shrink the screen image of the programme.

Playlist: Shows you a full list of films you can watch. Press the **EXIT** button to mclose the submenu.

Info: Shows information about the programme you are watching. Press the **EXIT** button to close the submenu.

Entertainment Features

Listening to music:

Use the ◀▶ buttons to select **Movie** folder then press the **OK** button.

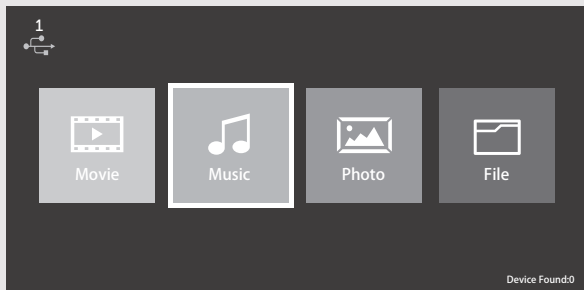

Use the ◀▶ buttons to select the USB device you want to look in (if more than one device is connected to your TV) then press the **OK** button.

Use the ▲▼◀▶ buttons to navigate through the folders and press the **OK** button to open the folder.

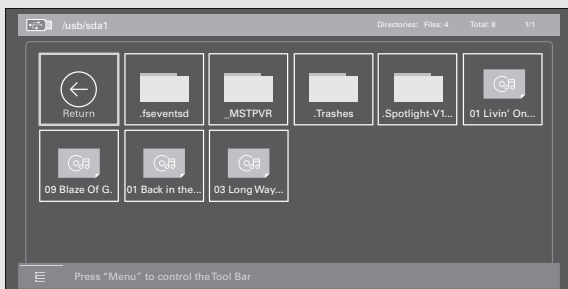

When you find the music track you want to listen to press the **OK** or ▶|| button to begin listening to it.

Note: If you want to delete the track press the **RED** button on the remote control.

If you want to copy the track press the **BLUE** button on the remote control once to copy and again to paste.

If you press the menu button on the remote control when the movie is playing the Movie Function Bar will be displayed.

Use the ◀▶ buttons to select the different functions available on the function bar, press the **OK** button to select the function.

List of functions

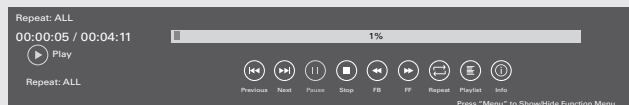

Play: Press to play the track.

Previous: Press to skip to previous track.

Next: Press to move to next track.

Pause: Press to pause the track.

Stop: Press to stop the track.

FB: Press to rewind the track.

FF: Use to fast forward the track.

Repeat: Press to select the repeat function you want. Choose from NONE / ONE / ALL / RANDOM.

Playlist: Shows you a full play list. Press **EXIT** button to close.

Info: Shows information about the track. Press **EXIT** button to close.

Press the **MENU** button to hide and show the function bar.

Press the **EXIT** button to go back to the main USB menu.

Entertainment Features

Viewing photos

Use the ◀▶ buttons to select **Photo** folder then press the **OK** button.

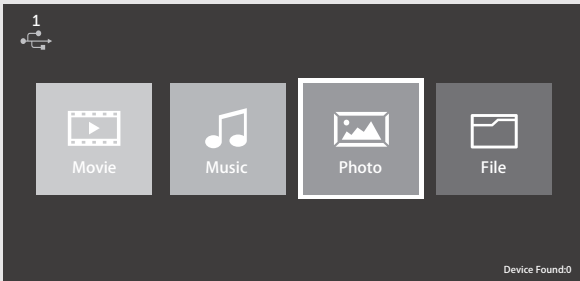

Use the ◀▶ buttons to select the USB device you want to look in (if more than one device is connected to your TV) then press the **OK** button.

Use the ▲▼◀▶ buttons to navigate through the folders and press the **OK** button to open the folder.

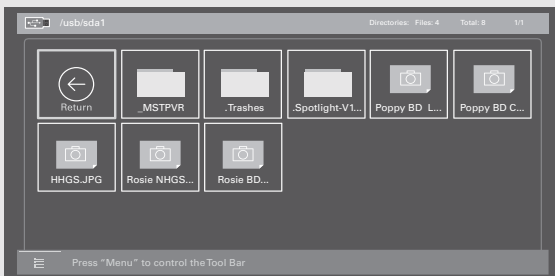

When you find the photo you want to see to press the **OK** or ▶|| button to view it.

Note: If you want to delete the photo press the **RED** button on the remote control.

If you want to copy the track press the **BLUE** button on the remote control once to copy and again to paste.

If you press the menu button on the remote control when the movie is playing the Movie Function Bar will be displayed.

Use the ◀▶ buttons to select the different functions available on the function bar, press the **OK** button to select the function.

List of functions



Play: Press to view the image.

Previous: Press to view the previous photo.

Next: Press to view the next photo.

Pause: Press to pause the photo.

Stop: Press to go back to the menu.

Rotate -: Press to rotate clockwise.

Rotate +: Press to rotate anti clockwise.

Enlarge: Press to shrink the image.

Move: Use the ▲▼◀▶ buttons to move around the image. Press the **EXIT** button to close

Repeat: Press to select the repeat function you want. Choose from NONE / ONE / ALL / RANDOM.

Music: If you have music on the USB drive it will be played when viewing the photos.

Play List: Shows a list of all available photos. Press **EXIT** to close the sub menu.

Info.: Press to view information about the photo you are viewing. Press **EXIT** to close the sub menu.

Press the **MENU** button to hide and show the function bar.

Press the **EXIT** button to go back to the main USB menu.

Entertainment Features

Viewing photos

Use the ◀▶ buttons to select **File** folder then press the **OK** button.

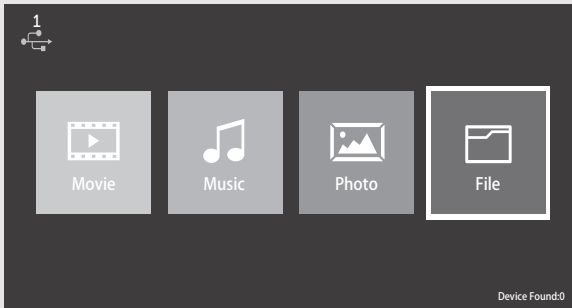

Use the ◀▶ buttons to select the USB device you want to look in (if more than one device is connected to your TV) then press the **OK** button.

Use the ▲▼◀▶ buttons to navigate through the folders and press the **OK** button to open the folder.

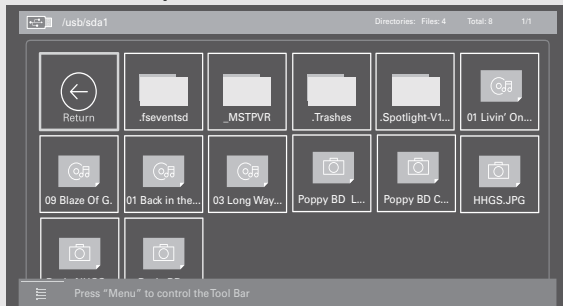

When you find the music or photo file you want to see to press the **OK** button.

Note: If you want to delete the photo press the **RED** button on the remote control.

You will now be taken automatically to the photo or music browser.

See the instructions for using the music and photo browsers on pages 40 and 41 in these instructions for more information.

Press the **EXIT** button to go back to the main USB menu.

Other Information

Specifications

TV Broadcasting	PAL, B/G, D/K, I, SECAM, L/L'
Receiving Channels	VHF (BAND I/III) - UHF (BAND U) - HYPERBAND
Number of Preset Channels	100
Channel Indicator	On Screen Display
RF Aerial Input	75 Ohm (unbalanced)
Operating Voltage	AC 100-240V~ 50/60Hz
Audio	Nicam
Audio Output Power (WRMS.) (10% THD)	2 x 6 W
Panel Dimensions DxLxH (with foot)	270 x 1134 x 720 mm
Weight (with foot)	11.8kg
Panel Dimensions DxLxH (without foot)	103 x 1134 x 669 mm
Weight (without foot)	11.6kg
Energy Consumption Data	EEI A
On Mode Power Consumption (W)	92W
Standby Mode (W)	0.5W
Maximum Power (W)	150W
Standby Mode	After 4 Hours

Digital reception

MHEG-5 ENGINE compliant with ISO/IEC 13522-5 UK engine Profile 1 - for UK
Object carousel support compliant with ISO/IEC 135818-6 and UK DTT profile - for UK
Frequency range: 474-850 MHz for UK models
170-862 MHz for EU models
Transmission standard: DVB-T. MPEG-2
Demodulation: COFDM with 2K/8K FFT mode
FEC: all DVB modes
Video: MP@ML, PAL, 4:3/16:9
Audio: MPEG Layer I&II 32/44.148kHz.

We apologise for any inconvenience caused by any minor inconsistencies in these instructions, which may occur as a result of product improvements and development.

Other Information

Plug replacement - UK and Ireland only

Should you need to replace the plug; the wires in the power cable are coloured in the following way:

Blue – Neutral 'N'

Brown – Live 'L'

As the colours of the wires in the power cable may not correspond with the coloured markings identifying the terminals in your plug, and proceed as follows:

The blue wire must be connected to the terminal that is marked with the letter N.

The brown wire must be connected to the terminal that is marked with the letter L.

If the power lead is damaged, it must be replaced by a qualified electrician.

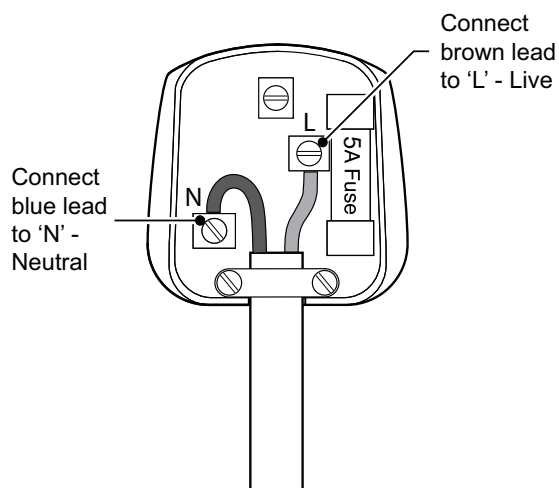

Energy label

This is called the product Fiche – the information needs to be presented in the following order, also this maybe in the form of a copy of the label, in colour or black and white – the label however must display all the information below:

- Supplier's name or trade mark
- Supplier's model product model no.
- The energy efficiency class of the model
- The visible screen diagonal in centimetres and in inches
- The on-mode power consumption
- The annual energy consumption
- The screen resolution in physical horizontal and vertical pixel count

Product Support

Trouble shooting

Image persistence - ghosting

Please note that ghosting may occur while displaying a persistent image (still or paused image). LCD TVs' image persistence may disappear after a short time. Try turning off the TV for a while. To avoid this, do not leave the screen in still picture mode for extended periods.

No power

If your TV has no power, please check the power cord plug is connect to the mains power socket.

Poor picture

1. Have you selected the correct TV system?
2. Is your TV or house aerial located too close to a non-earthed audio equipment or neon lights, etc.?
3. Mountains or high buildings can cause double pictures or ghost images. Sometimes you can improve the picture quality by changing the direction of the aerial. Is the picture or teletext unrecognisable?
4. Check if you have entered the correct frequency.
5. Please retune the channels.
6. The picture quality may degrade when two devices are connected to the TV at the same time. In such a case, disconnect one of the devices.

No picture

1. No Picture means that your TV is not receiving a transmission. Have you selected the correct button on the remote control? Try once more. Also make sure the correct input source has been selected.
2. Is the aerial connected properly?
3. Are the plugs connected tightly to the aerial socket?
4. Is the aerial cable damaged?
5. Are suitable plugs used to connect the aerial?
6. If you are in doubt, consult your dealer.

No sound

1. Has the TV been set to mute? To cancel mute, press the "⏸" button, or increase the volume level.
2. Sound is coming from only one speaker. Is the balance set to one extreme?

Remote control - does not operate

Your TV no longer responds to the remote control. The batteries may be exhausted, if so you can still use the control buttons on the left side of the TV.

Input sources - can not be selected

1. If you cannot select an input source, it is possible that no device is connected.
2. Check the AV cables and connections if you have tried to connect a device.

Wrong OSD language

1. Select the language in the setup menu.
2. The language for the sound or subtitles on a DVD disc cannot be changed.
3. Multilingual sound and/or subtitles are not recorded on the DVD disc.
4. Try to change the sound or subtitles using DVD's title menu. Some DVD's do not allow the user to change these settings without using the disc's menu.

Product Support

Supported file formats

Media	File Extension	Format		Supported (Maximum resolution/Bit rate etc.)
		Video	Audio	
Movie	.mpg/.dat/.vob	MPEG1	MPEG Layer 1/2/3	
		MPEG2	MPEG2	
		MPEG2	MPEG2	
Music	-	-	PMC	Sample Rate: 8K ~ 48KHz
	.mp3	-	MPEG 1/2 Layer 1/2/3 MP3)	Sample Rate: 8K ~ 48KHz, Bit Rate: 64K ~ 320Kbps
Photo	.jpg	Baseline JPEG		W x H = 8192 x 8192 up to 77 Mega-pixel Support format: 444/ 440/ 422/ 420/ Grayscale
		Progressive JPEG		Up to 4 Mega-pixel Support format: 444/ 440/ 422/ 420/ Grayscale

Disposal information

Instructions for waste disposal:

Packaging and packaging aids are recyclable and should principally be recycled. Packaging materials, such as foil bag, must be kept away from children.

The cold cathode fluorescent lamp in LCD PANEL contains a small amount of mercury; please follow the local laws or regulations for disposal.

Information for Users on Disposal of old Equipment and Batteries (European Union only)

These symbols indicate that equipment with these symbols should not be disposed of as general household waste. If you want to dispose of the product or battery, please consider the collection systems or facilities for appropriate recycling.

Notice: The sign Pb below the symbol for batteries indicates that this battery contains lead.



Products



Battery

Information for Users in European Union Countries

This symbol on the product or on its packaging means that your electrical and electronic device should be disposed of at the end of its service life separately from your household wastes. There are separate collection systems for recycling in EU.

For more information, please contact the local authority or the dealer where you purchased the product.



BUSH

PRODUCT GUARANTEE

This product is guaranteed against manufacturing defects for a period of



Year

This product is guaranteed for twelve months from the date of original purchase. Any defect that arises due to faulty materials or workmanship will either be replaced, refunded or repaired free of charge where possible during this period by the dealer from whom you purchased the unit.

The guarantee is subject to the following provisions:

- The guarantee does not cover accidental damage, misuse, cabinet parts, knobs or consumable items.
- The product must be correctly installed and operated in accordance with the instructions contained in this manual.
- It must be used solely for domestic purpose.
- The guarantee will be rendered invalid if the product is re-sold or has been damaged by inexperienced repair.
- Specifications are subject to change without notice.
- The manufacturer disclaims any liability for the incidental or consequential damages.
- The guarantee is in addition to, and does not diminish your statutory or legal rights.

Guarantor: Argos Ltd
489 - 499 Avebury Boulevard
Central Milton Keynes
MK9 2NW

