

Panasonic®

Operating Instructions Home Theater Audio System

Model No. SC-HTB8

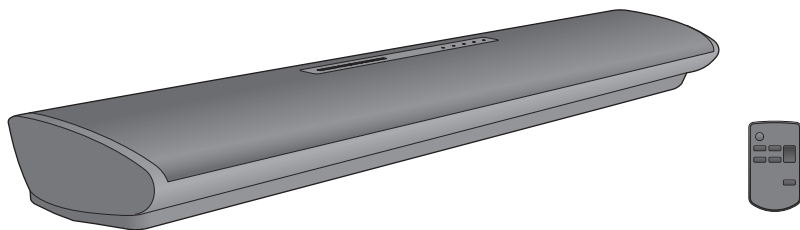

Thank you for purchasing this product.
Please read these instructions carefully before using this product,
and save this manual for future use.

Included Installation Instructions

The installation work should be done by a qualified installation specialist. (⇒ 10 to 14)
Before commencing work, carefully read these installation instructions and the operating instructions
to ensure that installation is performed correctly.
(Please keep these instructions. You may need them when maintaining or moving this unit.)

Model number suffix "EB" denotes UK model.

EG EB GN

VQT5J42

Safety precautions

WARNING

Unit

- To reduce the risk of fire, electric shock or product damage,
 - Do not expose this unit to rain, moisture, dripping or splashing.
 - Do not place objects filled with liquids, such as vases, on this unit.
 - Use only the recommended accessories.
 - Do not remove covers.
 - Do not repair this unit by yourself. Refer servicing to qualified service personnel.
- To prevent injury, this apparatus must be securely attached to the wall in accordance with the installation instructions.

AC mains lead

- To reduce the risk of fire, electric shock or product damage,
 - Ensure that the power supply voltage corresponds to the voltage printed on this unit.
 - Insert the mains plug fully into the socket outlet.
 - Do not pull, bend, or place heavy items on the lead.
 - Do not handle the plug with wet hands.
 - Hold onto the mains plug body when disconnecting the plug.
 - Do not use a damaged mains plug or socket outlet.
- The mains plug is the disconnecting device. Install this unit so that the mains plug can be unplugged from the socket outlet immediately.

Button-type battery (Lithium battery)

- Risk of fire, explosion and burns. Do not recharge, disassemble, heat above 60 °C or incinerate.
- Keep the Button-Type battery out of the reach of children. Never put Button-Type battery in mouth. If swallowed call your doctor.

Small object

- Keep the button-type battery out of reach of children to prevent swallowing.

CAUTION

Unit

- Do not place sources of naked flames, such as lighted candles, on this unit.
- This unit may receive radio interference caused by mobile telephones during use. If such interference occurs, please increase separation between this unit and the mobile telephone.
- This unit is intended for use in moderate climates.
- Product Identification Marking is located on the bottom of the unit.

Placement

- Place this unit on an even surface.
- To reduce the risk of fire, electric shock or product damage,
 - Do not install or place this unit in a bookcase, built-in cabinet or in another confined space. Ensure this unit is well ventilated.
 - Do not obstruct this unit's ventilation openings with newspapers, tablecloths, curtains, and similar items.
 - Do not expose this unit to direct sunlight, high temperatures, high humidity, and excessive vibration.

Button-type battery (Lithium battery)

- Danger of explosion if battery is incorrectly replaced. Replace only with the type recommended by the manufacturer.
- Insert with poles aligned.
- Mishandling of batteries can cause electrolyte leakage and may cause a fire.
 - Remove the battery if you do not intend to use the remote control for a long period of time. Store in a cool, dark place.
 - Do not heat or expose to flame.
 - Do not leave the battery(ies) in a car exposed to direct sunlight for a long period of time with doors and windows closed.
- When disposing of the batteries, please contact your local authorities or dealer and ask for the correct method of disposal.

Caution for AC Mains Lead

(For the AC mains plug of three pins)

For your safety, please read the following text carefully.

This appliance is supplied with a moulded three pin mains plug for your safety and convenience. A 5-ampere fuse is fitted in this plug.

Should the fuse need to be replaced please ensure that the replacement fuse has a rating of 5-ampere and that it is approved by ASTA or BSI to BS1362.

Check for the ASTA mark  or the BSI mark  on the body of the fuse.

If the plug contains a removable fuse cover you must ensure that it is refitted when the fuse is replaced.

If you lose the fuse cover the plug must not be used until a replacement cover is obtained.

A replacement fuse cover can be purchased from your local dealer.

Before use

Remove the connector cover.

How to replace the fuse

The location of the fuse differ according to the type of AC mains plug (figures A and B). Confirm the AC mains plug fitted and follow the instructions below. Illustrations may differ from actual AC mains plug.

1. Open the fuse cover with a screwdriver.

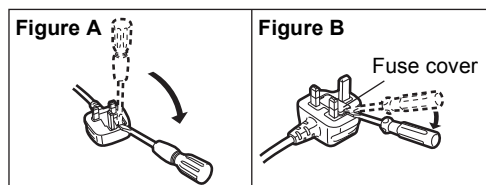

2. Replace the fuse and close or attach the fuse cover.

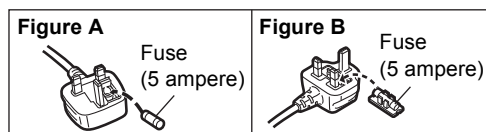

About Bluetooth®

Panasonic bears no responsibility for data and/or information that is compromised during a wireless transmission.

■ Frequency band used

This system uses the 2.4 GHz frequency band.

■ Certification of this device

- This system conforms to frequency restrictions and has received certification based on frequency laws. Thus, a wireless permit is not necessary.
- The action below are punishable by law in some countries:
 - Taking apart or modifying the unit.
 - Removing specification indications.

■ Restrictions of use

- Wireless transmission and/or usage with all Bluetooth® equipped devices is not guaranteed.
- All devices must conform to standards set by Bluetooth SIG, Inc.
- Depending on the specifications and settings of a device, it can fail to connect or some operations can be different.
- This system supports Bluetooth® security features. But depending on the operating environment and/or settings, this security is possibly not sufficient. Transmit data wirelessly to this system with caution.
- This system cannot transmit data to a Bluetooth® device.

■ Range of use

Use this device at a maximum range of 10 m.

The range can decrease depending on the environment, obstacles or interference.

■ Interference from other devices

- This system may not function properly and troubles such as noise and sound jumps may arise due to radio wave interference if the main unit is located too close to other Bluetooth® devices or the devices that use the 2.4 GHz band.
- This system may not function properly if radio waves from a nearby broadcasting station, etc. are too strong.

■ Intended usage

- This system is for normal, general use only.
- Do not use this system near equipment or in an environment that is sensitive to radio frequency interference (example: airports, hospitals, laboratories, etc).

Table of contents

Safety precautions.....	2
Caution for AC Mains Lead.....	3
About Bluetooth®.....	3

Before use

Supplied items	5
This system	5
Accessory	5
Control reference guide	6
This system (Front).....	6
This system (Rear).....	6
Remote control	7

Getting started

Step 1 Connections	8
Connection with the TV	8
Connection with other devices.....	8
AC mains lead connection.....	8
Bluetooth® connection.....	9
Step 2 Placement	10
Safety Precautions	10
Wireless interference.....	10
Selecting the placement method	11
When placing the main unit on a rack or on a table	12
When attaching the main unit to a wall.....	13

Operations

Using this system	15
Advanced operations	16

Reference

Troubleshooting	17
Unit care	18
License	18
Indicator illumination	18
Specifications	19
Limited Warranty (ONLY FOR AUSTRALIA).....	23

- The illustrations shown may differ from your unit.
- These operation instructions are applicable to model SC-HTB8 for variety of regions. Unless otherwise indicated, illustrations in these operating instructions are of the model for the United Kingdom and Ireland.
- Operations in this operating instructions are described mainly with the remote control, but you can perform the operations on the main unit if the controls are the same.

Supplied items

This system

- 1 Main unit (Speaker)**
(SC-HTB8)

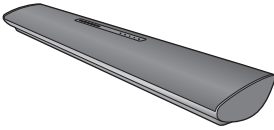

Accessory

Check the supplied accessory before using this system.

- 1 Remote control
(with a battery)**
(N2QAYC000102)



- Product numbers are correct as of March 2014. These may be subject to change.

Control reference guide

This system (Front)

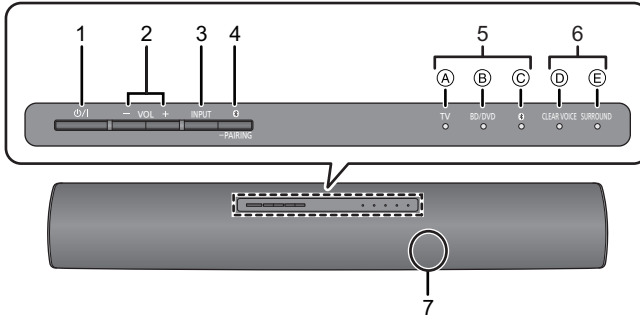

- 1 Standby/on switch (⏻/⏻)**
Press to switch the unit from on to standby mode or vice versa. In standby mode, the unit is still consuming a small amount of power.
- 2 Adjust the volume of this system (⇒ 15)**
- 3 Select the input source (⇒ 15)**
“TV” → “BD/DVD” → “Ⓜ” (Bluetooth®)
↑
↑
- 4 Select the Bluetooth® device as the source (⇒ 15)**
- 5 Input selector indicators*1**
 - A TV indicator**
Lights green when the TV is the audio source
 - B BD/DVD indicator**
Lights amber when the device connected to the BD/DVD terminal is the audio source
 - C Bluetooth® indicator**
Lights amber when the Bluetooth® device is the audio source
- 6 Sound mode indicators*1**
 - D CLEAR VOICE indicator**
Lights amber when clear voice is the current sound mode
 - E SURROUND indicator**
Lights amber when surround is the current sound mode
- 7 Remote control signal sensor (⇒ 7)**

This system (Rear)

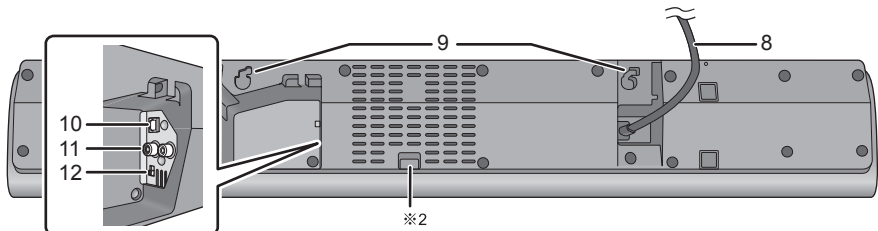

- 8 AC mains lead (⇒ 8)**
- 9 Wall mounting hole**
- 10 OPTICAL DIGITAL AUDIO IN terminal (⇒ 8)**
- 11 AUDIO IN terminal (⇒ 8)**
- 12 MULTI ANGLE switch (⇒ 12, 13)**
Switch the audio quality according to the placement method of the main unit.

※1 The indicators will also blink in various conditions. (⇒ 18)

※2 For service use only

Remote control

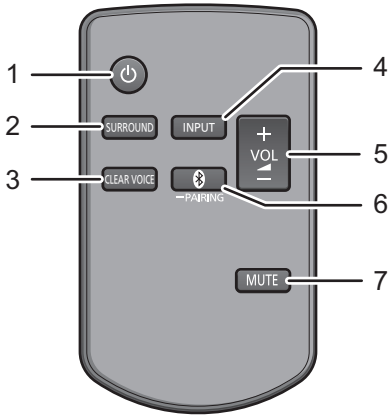

- 1 Turn the main unit on or off (⇒ 15)
- 2 Turn the surround effect on or off (⇒ 15)
- 3 Turn the clear voice effect on or off (⇒ 15)
- 4 Select the input source (⇒ 15)
 “TV” → “BD/DVD” → “Bluetooth®”
- 5 Adjust the volume of this system (⇒ 15)
- 6 Select the Bluetooth® device as the source (⇒ 15)
- 7 Mute the sound (⇒ 15)

■ Before using for the first time

Remove the insulation sheet **A**.

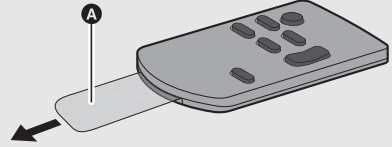

■ To replace a button-type battery

Battery type: CR2025 (Lithium battery)

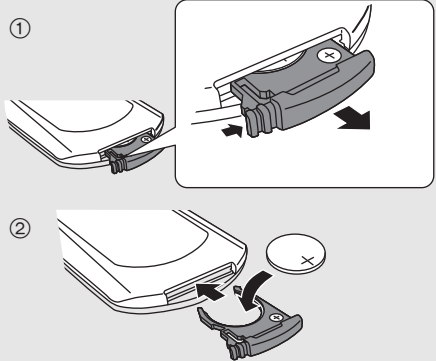

- Set the button-type battery with its (+) mark facing upward.

■ About remote control signal sensor

The remote control signal sensor is located on the main unit.

- Use the remote control within the correct operation range.
 Distance: Within approx. 7 m directly in front
 Angle: Approx. 30° left and right

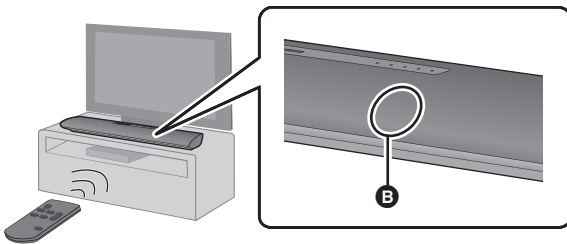

- B** Remote control signal sensor

Step 1 Connections

- Turn off all equipment before connection and read the appropriate operating instructions.
- Do not connect the AC mains lead until all other connections are completed.

Connection with the TV

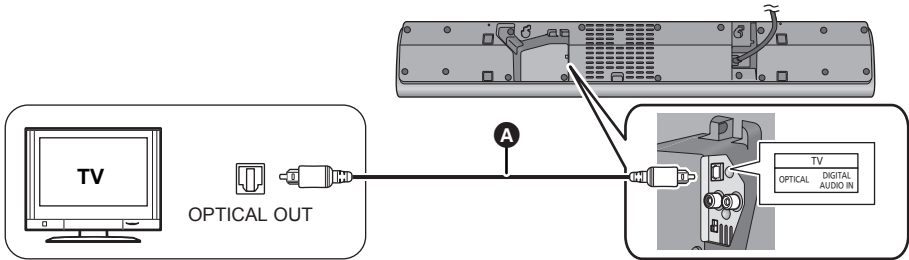

A Optical digital audio cable

- When you use the optical digital audio cable, insert the tip correctly into the terminal.
- Do not bend the optical digital audio cable.
- The optical input supports PCM only.

Connection with other devices

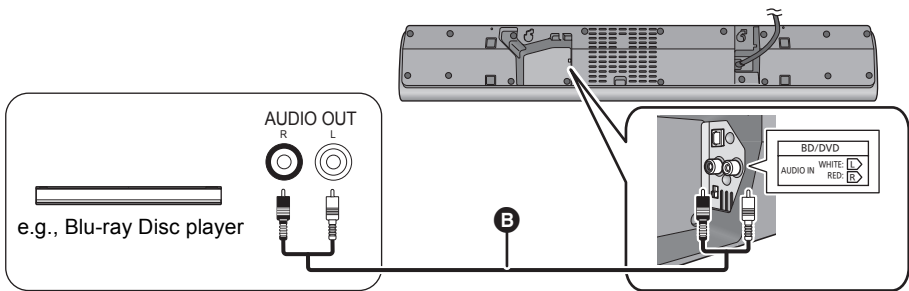

B Audio cable

AC mains lead connection

- Connect only after all other connections are completed.

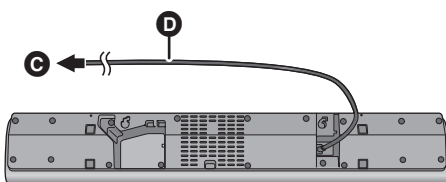

C To a household mains socket

D AC mains lead

- This system consumes a small amount of AC power (⇒ 19) even when it is turned off. In the interest of power conservation, if you will not be using this system for a long time, unplug it from the household mains socket.

Saving energy

The main unit is designed to conserve its power consumption and save energy.

- The main unit will automatically switch to standby mode when no signal is input and no operation is performed for approx. 2 hours. Refer to page 16, "Auto Power Down" to turn this function off.

Bluetooth® connection

By using the Bluetooth® connection, you can listen to the sound from the Bluetooth® audio device from this system wirelessly.

- Refer to the operating instructions of the Bluetooth® device for further instruction on how to connect a Bluetooth® device.

Preparation

- Turn on the Bluetooth® feature of the device and place the device near the main unit.

Bluetooth® pairing

1 Press [] to select “”.

- If the “” indicator flashes quickly, go to step 3.

2 Press and hold [] until the “” indicator flashes quickly.

- If the “” indicator flashes slowly, repeat step 2.

3 Select “SC-HTB8” from the Bluetooth® device’s Bluetooth® menu.

- If prompted for the passkey on the Bluetooth® device, enter “0000”.
- Once the Bluetooth® device is connected, the “” indicator stops flashing and lights up.



You can register up to 8 devices with this system. If a 9th device is paired, the device that has not been used for the longest time will be replaced.



Connecting a paired Bluetooth® device

1 Press [] to select “”.

- If the “” indicator lights, a Bluetooth® device is already connected with this system. Disconnect it. (⇒ below)

2 Select “SC-HTB8” from the Bluetooth® device’s Bluetooth® menu.

■ Disconnecting a Bluetooth® device

Press and hold [] until the “” indicator flashes slowly.



- When “” is selected as the source, this system will automatically try and connect to the last connected Bluetooth® device. If the connection attempt fails, try to establish a connection again.
- The Bluetooth® device will be disconnected if a different audio source (e.g. “TV”) is selected.
- This system can only be connected to one device at a time.

Step 2 Placement

Safety Precautions

Professional installation is required.

The installation should never be done by any other than a qualified installation specialist. PANASONIC DISCLAIMS ANY PROPERTY DAMAGE AND/OR SERIOUS INJURY, INCLUDING DEATH RESULTING FROM IMPROPER INSTALLATION OR INCORRECT HANDLING.

- Be sure to install the main unit as indicated within this operating Instructions.
- Attach using techniques suited to the structure and materials of the installation location.

Caution

- This system is to be used only as indicated in these instructions. Failure to do so may lead to damage to the amplifier and/or the speaker, and may result in the risk of fire. Consult a qualified service person if damage has occurred or if you experience a sudden change in performance.
- Do not attempt to attach the main unit to a wall using methods other than those described in this manual.



- Do not hold the main unit in one hand to avoid injury, you may drop the main unit when carrying it.
- To prevent damage or scratches, lay down a soft cloth and perform the assembly on it.

Wireless interference

To avoid interference, maintain the following distances between the main unit and other electronic devices that use the same radio frequency (2.4 GHz band).

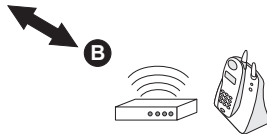

- A** Main unit
- B** Wireless router, cordless phone and other electronic devices: approx. 2 m

Selecting the placement method

Choose a placement method that suits you best.

When placing the main unit on a rack or on a table

- Place the main unit on a flat and horizontal surface.
- Place the main unit in front of the TV pedestal.



➔
Page 12

When attaching the main unit to a wall

- Place the main unit on a flat and vertical surface.



➔
Page 13

■ When placing the main unit in front of the TV

The main unit may block or interfere with the TV's various sensors (C.A.T.S. (Contrast Automatic Tracking System) sensor, remote control sensor, etc.) and the 3D Eyewear transmitters on a 3D compatible TV.

- If interference occurs, move the main unit further away from the TV. If the TV still does not function correctly, try using it in a rack or in the wall mount position.

■ If the TV's remote control sensor is blocked by the main unit

Try using the TV's remote control from a different angle.



- Do not use the main unit in a metal cabinet.
- If irregular colouring occurs on your TV, turn the TV off for about 30 minutes. If it persists, move the main unit further away from the TV.
- Keep magnetised items away. Magnetised cards, watches, etc., can be damaged if placed too close to the main unit.
- Keep the main unit approximately 150 mm away from the TV.

When placing the main unit on a rack or on a table

Additionally required accessories (commercially available)

- Fall prevention cord × 1
- Screw eye (to attach the fall prevention cord)..... × 1



- Use commercially available screws that are capable of supporting over 33 kg.
- Use a cord that is capable of supporting over 10 kg (with a diameter of about 2 mm).

1 Slide the MULTI ANGLE switch to "RACK/TABLE TOP".

- Press the AC mains lead into the holder.

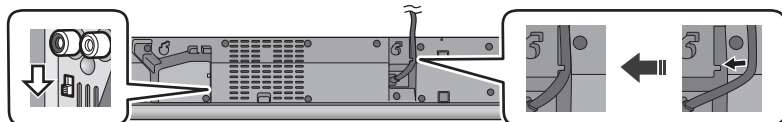

2 Attach the cord to the main unit.

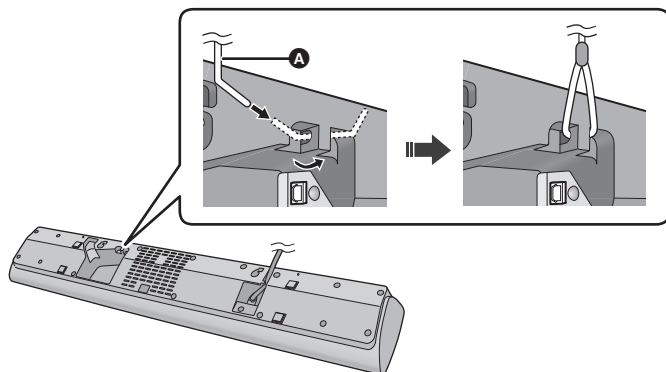

A Cord*

- ※ If the cord cannot be threaded through the holes, try bending the cord in 2 locations, about 5 mm apart from the tip, at an angle of 45° (as illustrated above).

3 Place the main unit in the desired position and attach the cord onto the rack or table.

- Make sure that the slack of the cord is minimal.
- Do not lean the main unit against the TV or wall.
- Do not place the main unit over the AC mains lead.
- Ensure that the main unit is stable.

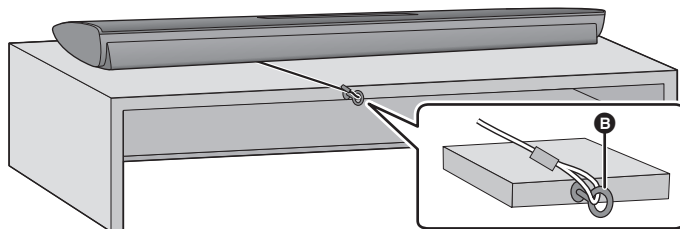

B Screw eye

- Attach at a position capable of supporting over 10 kg.
- Depending on the placement of the main unit, the screwing position of the screw eye may differ.

When attaching the main unit to a wall

Make sure that the screw used and the wall are strong enough to support the weight of at least 33 kg. The screws and other items are not supplied as the type and size will vary with each installation.

- Refer to step 3 for details about the required screws.
- Be sure to attach the fall prevention cord as a secondary safety measure.

Additionally required accessories (commercially available)

- | | |
|--|-----|
| • Screws for wall mounting | × 2 |
| • Fall prevention cord | × 1 |
| • Screw eye (to attach the fall prevention cord) | × 1 |



- Use a cord that is capable of supporting over 10 kg (with a diameter of about 2 mm).

1 Slide the MULTI ANGLE switch to “WALL MOUNT”.

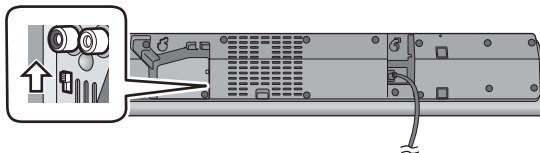

2 Attach the cord to the main unit.

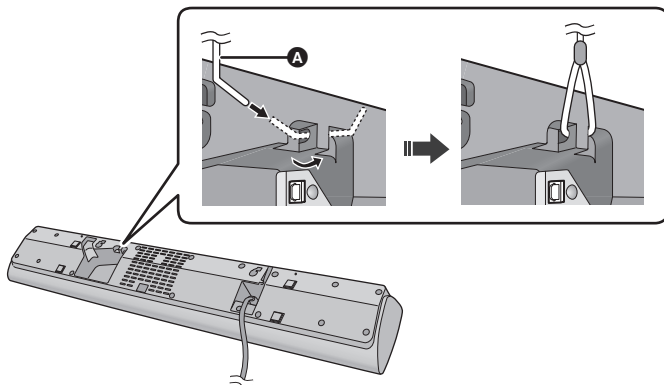

A Cord*

- ※ If the cord cannot be threaded through the holes, try bending the cord in 2 locations, about 5 mm apart from the tip, at an angle of 45° (as illustrated above).

3 Drive a screw into the wall.

- Use the measurements indicated below to identify the screwing positions on the wall.
- Leave at least 20 mm of space above of the main unit to allow enough space for fitting the main unit.
- Leave at least 10 mm of space on both sides of the main unit. Without sufficient space, it is not possible to mount the main unit successfully.
- Be sure to use a level to insure that both mounting holes are level to each other.

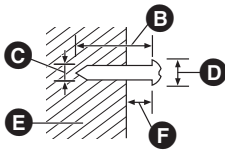

- B** At least 30 mm
- C** $\varnothing 4.0$ mm
- D** $\varnothing 7.5$ mm to $\varnothing 9.4$ mm
- E** Wall or pillar
- F** 7.5 mm to 8.5 mm

Front view (semi-transparent image)

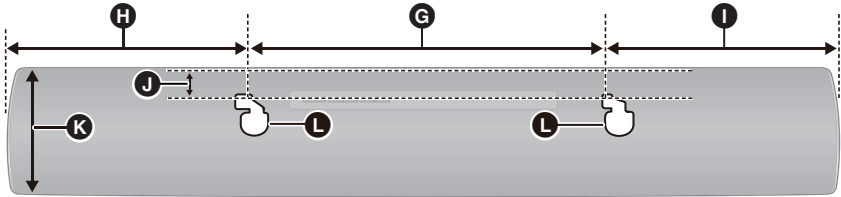

- G** 320 mm
- H** 215 mm
- I** 215 mm
- J** 15 mm
- K** 115 mm
- L** Wall mounting hole

4 Fit the main unit securely onto the screw(s).

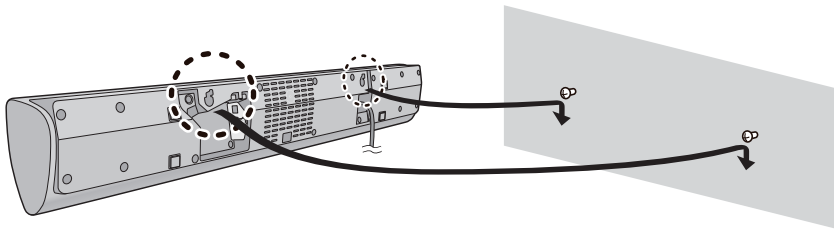

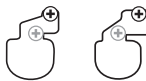
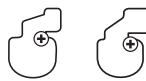
DO	DO NOT
 <ul style="list-style-type: none"> • Move the speaker so that the screw is in this position. 	 <ul style="list-style-type: none"> • In this position, the speaker will likely fall if moved to the left or right.

5 Secure the cord to the wall.

- Make sure that the slack of the cord is minimal.

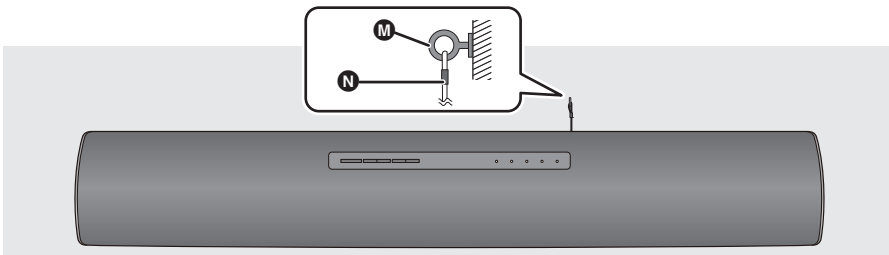

- M** Screw eye
- N** Cord

Using this system

Preparation

- Turn on the TV and/or connected device.

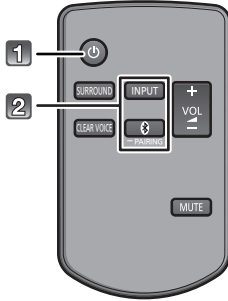

1 Press [⏻] to turn on the main unit.

2 Select the source.

Press	To select
[INPUT]	“TV” → “BD/DVD” ↑ “Ⓛ” (Bluetooth®) ↓
[Ⓛ]	“Ⓛ” (Bluetooth®)

- This remote control cannot be used to control the operations of the connected devices.

■ When “Ⓛ” is selected as the source

On the Bluetooth® device:

Select this system as the output source of the connected Bluetooth® device and start the playback.

■ When “BD/DVD” is selected as the source

On the TV and the connected device:

Select the TV’s input for this system and start the playback on the connected device.



If this system does not operate as expected or sound is unusual, returning the settings to the factory preset may solve the problem. (⇒ 17)

- ※ BD/DVD indicator, Bluetooth® indicator and sound mode indicators blink from left to right (+) or from right to left (–) while adjusting. The indicators will not blink when it has reached the maximum or minimum.
- If there is sound coming out of the TV’s speakers, reduce the volume of the TV to its minimum.
- If the main unit is turned off with the volume setting in the greater half (above 50), the main unit will automatically lower the volume to the middle (50) when the main unit is turned on (Volume limitation). To turn this function off, refer to page 16.

■ To adjust the volume of this system

Press [+ VOL –].

- Volume range: 0 to 100*

■ To set the surround mode

You can enable/disable the surround effect.

Press [SURROUND].

- To cancel, press the button again.

■ To set the clear voice mode

With the clear voice mode you can hear dialogs clearer.

Press [CLEAR VOICE].

- To cancel, press the button again.

■ To mute the sound

Press [MUTE].

- While muting, all the indicators blink simultaneously.
- To cancel, press the button again or adjust the volume.
- Muting is cancelled if the main unit is turned off.

Advanced operations

Auto Power Down

The main unit is automatically turned off if there is no audio input and when you do not use it for approx. 2 hours.

- 1 While pressing and holding [CLEAR VOICE] on the remote control, press and hold [INPUT] on the main unit for more than 4 sec to display the current setting.**



"BD/DVD" indicator blinks:
Auto Power Down is on.



"CLEAR VOICE" indicator blinks:
Auto Power Down is off.

- 2 While the setting is displayed, press [CLEAR VOICE] to select the setting.**

- The setting changes each time [CLEAR VOICE] is pressed.
- The indicator for the selected setting blinks for 20 sec and then exits the setting mode.
- The setting is maintained until it is changed again.
- Default setting of this function is on.

Bluetooth® Stand-by

This function allows you to connect a paired Bluetooth® device when the main unit is in standby mode.

- 1 While pressing and holding [SURROUND] on the remote control, press and hold [Ⓜ] on the main unit for more than 4 sec to display the current mode.**



"BD/DVD" indicator blinks:
Bluetooth® Stand-by is on.



"CLEAR VOICE" indicator blinks:
Bluetooth® Stand-by is off.

- 2 While the mode is displayed, press [SURROUND] to select the mode.**

- The setting changes each time [SURROUND] is pressed.
- The indicator for the selected setting blinks for 20 sec and then exits the setting mode.
- The setting is maintained until it is changed again.
- Default setting of this function is off.

Dimmer mode

You can turn off dimmer mode and keep the LED indicators bright.

While pressing and holding [INPUT] on the remote control, press and hold [- VOL] on the main unit for more than 4 sec to turn off Dimmer mode.

- The indicator for the current condition will turn brighter.
- The setting is maintained until it is changed again.
- Default setting of this function is on.



To turn on dimmer mode, repeat the operation above. After performing the operation, the indicator for the current condition will be dim.

Others

Remote control code

When other Panasonic devices respond to this system's remote control, change the remote control code on this system and the remote control.

Preparation

- Turn off all other Panasonic products.
- Turn on the main unit.

Change the remote control code to code 2:

- 1 Aim the remote control at the main unit's remote control sensor.
- 2 Press and hold [MUTE] and [Ⓜ] on the remote control for more than 4 sec.

- All the indicators will blink for 10 sec when the code of this system is changed.



- The setting is maintained until it is changed again.



- If the main unit does not operate after changing the code, repeat steps 1 and 2.
- To change the remote control code to code 1, repeat the steps above, but replace [Ⓜ] with [INPUT].

To turn off the volume limitation

If a state of the lowered volume disturbs you every time the main unit turns on, for example, it is possible to turn off this function as follows:

While pressing and holding [MUTE] on the remote control, press and hold [VOL +] on the main unit for more than 4 sec.

- All the indicators will blink once when the volume limitation is turned off.



To reset the setting, return to the factory preset. (⇒ 17)

Troubleshooting

Before requesting service, make the following checks. If you are in doubt about some of the check points, or if the solutions indicated in the following guide do not solve the problem, consult your dealer for instructions.

To return to the factory defaults.

While the main unit is on, press and hold [⏻/⏪] on the main unit for more than 4 sec.

(All the indicators will blink twice when this system is reset.)

If this system does not operate as expected, returning the settings to the factory defaults may solve the problem.

- The remote control code will return to “1” when this system is returned to the factory preset. To change the remote control code, refer to page 16.

General operation

No power.

- Insert the AC mains lead securely. (⇒ 8)
- If the indicators blink and the main unit turns off immediately after you have turned it on, unplug the AC mains lead and consult your dealer.

The remote control does not work properly.

- The battery is depleted. Replace it with a new one. (⇒ 7)
- It is possible that the insulation sheet has not been removed. Remove the insulation sheet. (⇒ 7)
- It may be necessary to set the code of the remote control again after changing the battery of the remote control. (⇒ 16)
- Use the remote control within the correct operation range. (⇒ 7)

The “TV” indicator blinks.

Unplug the AC mains lead and consult your dealer. If other indicators are also blinking, be sure to inform your dealer of these indicators.

The main unit is automatically switched to standby mode.

“Auto Power Down” function is on.

The main unit will automatically switch to standby mode when no signal is input and no operation is performed for approx. 2 hours. Refer to page 16 to turn this function off.

Bluetooth®

Pairing cannot be done.

Check the Bluetooth® device condition.

The device cannot be connected.

- The pairing of the device was unsuccessful or the registration has been replaced. Try pairing the device again. (⇒ 9)
- This system might be connected to a different device. Disconnect the other device and try pairing the device again.

The device is connected but audio cannot be heard through this system.

For some built-in Bluetooth® devices, you have to set the audio output to “SC-HTB8” manually. Read the operating instructions for the device for details.

The sound is interrupted.

- The device is out of the 10 m communication range. Bring the Bluetooth® device closer to the main unit.
- Remove any obstacle between the main unit and the device.
- Other devices that use the 2.4 GHz frequency band (wireless router, microwaves, cordless phones, etc.) are interfering. Bring the Bluetooth® device closer to the main unit and distance it from the other devices.

Sound

No sound.

- Turn muting off. (⇒ 15)
- Check the connections to the other device. (⇒ 8)
- Make sure that the received audio signal is compatible with this system. (⇒ 19)
- Turn this system off and then on again.
- If the connections are correct, there might be a problem with the cables. Redo the connections with different cables.
- Check the audio output settings on the connected device.

The volume is lowered when the main unit is turned on.

If the main unit is turned off with the volume setting in the greater half (above 50), the main unit will automatically lower the volume to the middle (50) when the main unit is turned on. (⇒ 16)

The dialog is too persistent or the dialog does not sound natural.

This system has a function to make the dialog stand out when the volume is low. (⇒ 15)

There is no audio.

The power of the main unit turns off automatically.

(When the main unit detects a problem, a safety measure is activated and the main unit automatically switches to standby mode.)

- There is a problem with the amplifier.
 - Is the volume extremely high?
If so, lower the volume.
 - Is this system placed in an extremely hot place?
If so, move this system to a cooler place and wait a few moments and then try to turn it on again.
- If the problem persists, check if the TV indicator and the BD/DVD indicator are blinking first. After checking the indicators, turn off this system, unplug the AC mains lead, and consult your dealer. Make sure to remember which indicators were blinking and inform the dealer of them.

Unit care

■ Clean this system with a soft, dry cloth

- When dirt is heavy, wring a cloth moistened in water tightly to wipe the dirt, and then wipe it with a dry cloth.
- Never use alcohol, paint thinner or benzine to clean this system.
- Before using chemically-treated cloth, carefully read the instructions that came with the cloth.

■ To dispose or transfer this system

This system may keep the user settings information in the main unit. If you discard the main unit either by disposal or transfer, then follow the procedure to return all the settings to the factory presets to delete the user settings. (⇒ 17, "To return to the factory defaults.")





- The operation history may be recorded in the memory of the main unit.

License

The Bluetooth® word mark and logos are owned by the Bluetooth SIG, Inc. and any use of such marks by Panasonic Corporation is under license. Other trademarks and trade names are those of their respective owners.

Indicator illumination

The indicators display the condition of this system by flashing. The indicator patterns illustrated below are displayed during normal operational conditions. They do not refer to the indications of a problem.

Indicator	Description
	The indicator blinks for 20 sec. <ul style="list-style-type: none">• When the setting is on ("Auto Power Down" and "Bluetooth® Stand-by") (⇒ 16)
	The indicator blinks for 20 sec. <ul style="list-style-type: none">• When the setting is off ("Auto Power Down" and "Bluetooth® Stand-by") (⇒ 16)
	The indicators blink for 10 sec. <ul style="list-style-type: none">• When the remote control code is changed (⇒ 16) The indicators blink once. <ul style="list-style-type: none">• When changing the setting ("To turn off the volume limitation") (⇒ 16)
	The indicators blink twice. <ul style="list-style-type: none">• When the main unit is reset (⇒ 17) Bluetooth® indicator blinks quickly. <ul style="list-style-type: none">• When the main unit is ready for pairing (⇒ 9) Bluetooth® indicator blinks slowly. <ul style="list-style-type: none">• When the main unit is waiting to connect (⇒ 9) Bluetooth® indicator turns on. <ul style="list-style-type: none">• When the main unit is connected with a Bluetooth® device (⇒ 9)

Specifications

AMPLIFIER SECTION

RMS output power : Stereo mode
Front ch (non-simultaneous drive)
40 W per channel (1 kHz, 10 % THD, 8 Ω)
Total RMS Stereo mode power
80 W

SPEAKER SECTION

FRONT SPEAKER (L/R)
Type
1 way, 1 speaker system (passive radiator type)
Unit(s)
8 cm ×2 (Cone type)
Impedance
8 Ω
Passive Radiator
Unit(s)
8 cm ×2

Bluetooth® SECTION

Bluetooth® system specification
Bluetooth® Version 3.0
Wireless equipment classification
Class 2 (2.5 mW)
Supported profiles
A2DP (with SCMS-T)
Supported codec
SBC
Frequency band
2.4 GHz band FH-SS
Operating distance
approx. 10 m Line of sight

TERMINALS SECTION

Digital Audio Input (TV)
Optical digital input
Optical terminal
Sampling Frequency
32 kHz, 44.1 kHz, 48 kHz, 88.2 kHz, 96 kHz
Audio Format
LPCM
Analog Audio Input (BD/DVD)
Audio input
Pin jack

GENERAL

Power consumption
20 W
Power consumption in standby mode
Approx. 0.5 W

Power supply AC 220 V to 240 V, 50 Hz
For table top layout
Dimensions (W×H×D)
750 ×65.5 ×118 mm
For wall mounting layout
Dimensions (W×H×D)
750 ×115 ×65 mm
Mass
Approx. 2.3 kg
Operating temperature range
0 °C to +40 °C
Operating humidity range
20 % to 80 % RH (no condensation)



- Specifications are subject to change without notice.
- Mass and dimensions are approximate.
- Total harmonic distortion is measured by a digital spectrum analyzer.

Disposal of Old Equipment and Batteries

Only for European Union and countries with recycling systems



These symbols on the products, packaging, and/or accompanying documents mean that used electrical and electronic products and batteries must not be mixed with general household waste.

For proper treatment, recovery and recycling of old products and used batteries, please take them to applicable collection points in accordance with your national legislation.

By disposing of them correctly, you will help to save valuable resources and prevent any potential negative effects on human health and the environment.

For more information about collection and recycling, please contact your local municipality.

Penalties may be applicable for incorrect disposal of this waste, in accordance with national legislation.



Note for the battery symbol (bottom symbol):

This symbol might be used in combination with a chemical symbol. In this case it complies with the requirement set by the Directive for the chemical involved.

Safety information for customers in Norway

NORSK

ADVARSEL

Produkt

- For å redusere faren for brann, elektrisk støt eller skade på apparatet:
 - Utsett ikke produktet for regn, fukt, drypping eller sprut.
 - Ikke plasser objekter som er fylt med væske, som vaser, på apparatet.
 - Bruk kun anbefalt tilbehør.
 - Fjern ikke deksler.
 - Reparer ikke denne enheten selv, overlat service til kvalifisert servicepersonell.

Vekselstrømnett

- Nettstøpselet er trukket ut fra denne enheten. Installer denne enheten slik at nettstøpselet umiddelbart kan trekkes fra stikkkontakten.

FORSIKTIG

Produkt

- Plasser ikke åpen ild, slik som levende lys, oppå apparatet.
- Dette apparatet er beregnet for bruk under moderate klimaforhold.

Plassering

- For å redusere faren for brann, elektrisk støt eller skade på apparatet:
 - Ikke plasser apparatet i en bokhylle, et innebygget kabinett eller et annet lukket sted. Pass på at produktet er godt ventilert.
 - Apparatets ventilasjonsåpninger må ikke dekkes til med aviser, duker, gardiner eller lignende.

C € 0560

Declaration of Conformity (DoC)

Hereby, "*Panasonic Corporation*" declares that this product is in compliance with the essential requirements and other relevant provisions of Directive 1999/5/EC.
Customers can download a copy of the original DoC to our R&TTE products from our DoC server:
<http://www.doc.panasonic.de>
Contact to Authorised Representative: Panasonic Marketing Europe GmbH,
Panasonic Testing Centre, Winsbergring 15, 22525 Hamburg, Germany

This product is intended for general consumer. (Category 3)

Ελληνικά**Δήλωση συμμόρφωσης (DoC)**

Με την παρούσα, η "*Panasonic Corporation*" δηλώνει ότι το προϊόν αυτό είναι σύμφωνο με τις βασικές απαιτήσεις και άλλες σχετικές διατάξεις της οδηγίας 1999/5/EC.
Οι πελάτες μπορούν να κατεβάσουν ένα αντίγραφο του πρωτοτύπου DoC για τα R&TTE προϊόντα μας από τον DoC server μας:
<http://www.doc.panasonic.de>
Στοιχεία επικοινωνίας Εξουσιοδοτημένου Αντιπροσώπου:
Panasonic Marketing Europe GmbH,
Panasonic Testing Centre, Winsbergring 15, 22525 Hamburg, Γερμανία

Αυτό το προϊόν προορίζεται για καταναλωτές. (Κατηγορία 3)

Português**Declaração de Conformidade (DoC)**

Com o presente documento, a "*Panasonic Corporation*" declara que este produto é conforme os requisitos específicos e demais especificações referentes à Diretriz 1999/5/EC.
Os clientes podem baixar uma cópia da declaração de conformidade (DoC) para nossos produtos R&TTE do Server DoC:
<http://www.doc.panasonic.de>
Contacte o representante autorizado: Panasonic Marketing Europe GmbH,
Panasonic Testing Centre, Winsbergring 15, 22525 Hamburg, Alemanha

Este produto destina-se ao consumidor geral. (Categoria 3)

Lietuviškai**Atitikties deklaracija (AD)**

Bendrovė "*Panasonic Corporation*" patvirtina, kad šis gaminys tenkina direktyvos 1999/5/EB esminius reikalavimus ir kitas taikytinas nuostatas.
Mūsų R&TTE gaminių originalios atitikties deklaracijos kopija klientai gali atsisiųsti iš mūsų AD serverio:
<http://www.doc.panasonic.de>
Įgaliotojo atstovo adresas: "Panasonic Marketing Europe GmbH",
Panasonic Testing Centre, Winsbergring 15, 22525 Hamburg, Vokietija.

Šis gaminys skirtas bendrajam vartojimui. (3 kategorija.)

Slovensko**Izjava o skladnosti (DoC)**

S pričujočo izjavo podjetje "*Panasonic Corporation*" izjavlja, da so svoji izdelki skladni s poglavitnimi zahtevami in drugimi odgovarjajočimi predpisi direktive 1999/5/ES.
Stranka lahko naloži izvod izvirnega DoC o naših izdelkih R&TTE s strežnika DoC:
<http://www.doc.panasonic.de>
Pooblaščen zastopnik: Panasonic Marketing Europe GmbH,
Panasonic Testing Centre, Winsbergring 15, 22525 Hamburg, Nemčija

Izdelek je namenjen splošni uporabi. (Razred 3)

Slovensky**Vyhlasenie o zhode (DoC)**

"*Panasonic Corporation*" týmto prehlasuje, že tento výrobok je v zhode so základnými požiadavkami a ďalšími príslušnými ustanoveniami smernice 1999/5/ES.
Zákazníci si môžu stiahnuť kópiu pôvodného DoC na naše R&TTE výrobky z nášho servera DoC:
<http://www.doc.panasonic.de>
Kontakt na splnomocneného zástupcu: Panasonic Marketing Europe GmbH,
Panasonic Testing Centre, Winsbergring 15, 22525 Hamburg, Nemecko

Tento produkt je určený pre všeobecného spotrebiteľa. (Kategória 3)

Norsk

Samsvarserklæring (DoC)

"Panasonic Corporation" erklærer at utstyret er i samsvar med de grunnleggende krav og øvrige relevante krav i direktiv 1999/5/EF. Kundene kan laste ned en kopi av den originale samsvarserklæringen (DoC) for vårt R&TTE utstyr fra vår DoC server:

<http://www.doc.panasonic.de>

Kontakt vår autoriserte representant: Panasonic Marketing Europe GmbH, Panasonic Testing Centre, Winsbergring 15, 22525 Hamburg, Tyskland

Utstyret er beregnet på den vanlige forbruker (klasse 3).

Eesti keel

Vastavusdeklaratsioon (DoC)

"Panasonic Corporation" kinnitab käesolevaga, et see toode on vastavuses põhiliste nõuete ja muude direktiivi 1999/5/EÜ asjakohaste sätetega.

Kliendid saavad koopia meie R&TTE toodetele kehtiva originaalvastavusdeklaratsiooni koopia alla laadida meie DoC-serverist:

<http://www.doc.panasonic.de>

Võtke ühendust volitatud esindajaga: Panasonic Marketing Europe GmbH, Panasonic Testing Centre, Winsbergring 15, 22525 Hamburg, Germany

See toode on mõeldud tavakasutajale. (III kategooria)

Latviski

Atbilstības deklarācija (DoC)

Kompānija "Panasonic Corporation" ar šo paziņo, ka šis izstrādājums atbilst būtiskām prasībām un citām saistošām Direktīvas 1999/5/EK prasībām.

Pircēji var lejupielādēt oriģinālo DoC kopiju mūsu R&TTE izstrādājuma no mūsu DoC servera:

<http://www.doc.panasonic.de>

Lūdzam sazināties ar pilnvaroto parstāvi Panasonic Marketing Europe GmbH, Panasonic Testing Centre, Winsbergring 15, 22525 Hamburg, Germany

Šis izstrādājums ir paredzēts parastam patērētājam. (3. kategorija)

Türkçe

Uygunluk Beyannamesi (DoC)

"Panasonic Corporation" işbu ürünün başlıca standartlara ve 1999/5/EC Yönetmeliği tarafından öngörülen ilişkin hükümlere uygun olduğunu beyan etmektedir.

Müşterilerimiz R&TTE ürünlerimizin orijinal DoC belgesinin bir suretini aşağıda belirtilen DoC server'imizden indirebilirler:

<http://www.doc.panasonic.de>

Avrupa Birliği için temas adresi: Panasonic Services Europe, Panasonic Marketing Europe GmbH grubu şirketi, Panasonic Testing Centre, Winsbergring 15, 22525 Hamburg, Almanya

İşbu ürün genel tüketicilere yöneliktir. (Kategori 3)

Български

Декларация за съответствие (DoC)

"Panasonic Corporation" декларира, че този продукт съответства на съществените изисквания и другите приложими разпоредби на Директива 1999/5/EC.

Потребителите могат да свалят копие от оригиналните DoC към нашите продукти от типа R&TTE от сървъра, на който се съхраняват DoC:

<http://www.doc.panasonic.de>

За контакт с оторизиран представител: Panasonic Marketing Europe GmbH, Panasonic Testing Centre, Winsbergring 15, 22525 Hamburg, Германия

Този продукт е предназначен за обща употреба. (Категория 3)

Român

Declarație de Conformitate (DoC)

Prin prezenta, societatea "Panasonic Corporation" declară că produsul este conform cu cerințele esențiale și cu alte norme corespunzătoare Directivei 1999/5/EC.

Clienții pot descărca o copie a DoC-ului original al produselor noastre R&TTE de la adresa noastră DoC din Internet:

<http://www.doc.panasonic.de>

Contact la Reprezentanța autorizată: Panasonic Marketing Europe GmbH, Panasonic Testing Centre, Winsbergring 15, 22525 Hamburg, Germania

Acest produs a fost proiectat pentru clientela generală. (Categorie 3)

Magyar

Megfelelőségi Nyilatkozat (DoC)

Ezennel a "Panasonic Corporation" kijelenti, hogy a jelen termék kielégíti az 1999/5/EK Irányelv létfontosságú követelményeit és más vonatkozó rendelkezéseit.

A vásárlók letölthetik az R&TTE termékek eredeti DoC másolatát a DoC szerverünkről:

<http://www.doc.panasonic.de>

Forduljon a hivatalos márkaképviselethez: Panasonic Marketing Europe GmbH, Panasonic Testing Centre, Winsbergring 15, 22525 Hamburg, Németország

A termékét általános fogyasztóknak szánták. (3-as kategória)

Hrvatski

Deklaracija o podobnosti (DoC)

Ovime, "Panasonic Corporation" izjavljuje da je ovaj proizvod udovoljava osnovnim zahtjevima i ostalim relevantnim uvjetima Smjernice 1999/5/EC.

Kupci mogu preuzeti kopiju originalne DoC za naše R&TTE proizvode s našeg DoC poslužitelja:

<http://www.doc.panasonic.de>

Adresa ovlaštenog predstavništva: Panasonic Marketing Europe GmbH, Panasonic Testing Centre, Winsbergring 15, 22525 Hamburg, Njemačka

Ovaj proizvod je namijenjen za opću potrošnju. (kategorija 3)

Limited Warranty (ONLY FOR AUSTRALIA)

Panasonic Warranty

1. The product is warranted for 12 months from the date of purchase. Subject to the conditions of this warranty Panasonic or its Authorised Service Centre will perform necessary service on the product without charge for parts or labour, if in the opinion of Panasonic, the product is found to be faulty within the warranty period.
2. This warranty only applies to Panasonic products purchased in Australia and sold by Panasonic Australia or its Authorised Distributors or Dealers and only where the products are used and serviced within Australia or its territories. Warranty cover only applies to service carried out by a Panasonic Authorised Service Centre and only if valid proof of purchase is presented when warranty service is requested.
3. This warranty only applies if the product has been installed and used in accordance with the manufacturer's recommendations (as noted in the operating instructions) under normal use and reasonable care (in the opinion of Panasonic). The warranty covers normal domestic use only and does not cover damage, malfunction or failure resulting from use of incorrect voltages, incorrect installation, accident, misuse, neglect, build-up of dirt or dust, abuse, maladjustment of customer controls, mains supply problems, thunderstorm activity, infestation by insects or vermin, tampering or repair by unauthorised persons (including unauthorised alterations), introduction of sand, humidity or liquids, commercial use such as hotel, office, restaurant, or other business or rental use of the product, exposure to abnormally corrosive conditions or any foreign object or matter having entered the product.
4. This warranty does not cover the following items unless the fault or defect existed at the time of purchase:
 - (a) Cabinet Part(s)
 - (b) Video or Audio Tapes
 - (c) SD cards or USB devices
 - (d) User replaceable Batteries
 - (e) DVD, Blu-ray or Recordable Discs
 - (f) Video / Audio Heads from wear and tear in normal use
 - (g) Information stored on Hard Disk Drive, USB stick or SD card
 - (h) DTV reception issues caused by TV Aerial / Cabling / Wall socket(s)etc
5. Some products may be supplied with Ethernet connection hardware. The warranty is limited on such products and will not cover
 - (a) Internet and or DLNA connection / setup related problems
 - (b) Access fees and or charges incurred for internet connection
 - (c) The use of incompatible software or software not specifically stipulated in the product operations manual;and
 - (d) Any indirect or consequential costs associated with the incorrect use or misuse of the hardware, its connection to the internet or any other device.
6. To claim warranty service, when required, you should:
 - Telephone Panasonic's Customer Care Centre on 132600 or visit our website referred to below and use the Service Centre Locator for the name/address of the nearest Authorised Service Centre.
 - Send or take the product to a Panasonic Authorised Service Centre together with your proof of purchase receipt as a proof of purchase date. Please note that freight and insurance to and / or from your nearest Authorised Service Centre must be arranged by you.
 - Note that home or pick-up/delivery service is available for the following products in the major metropolitan areas of Australia or the normal operating areas of the nearest Authorised Service Centres:
 - Plasma/LCD televisions / displays (screen size greater than 103 cm)
7. The warranties hereby conferred do not extend to, and exclude, any costs associated with the installation, de-installation or re-installation of a product, including costs related to the mounting, de-mounting or remounting of any screen, (and any other ancillary activities), delivery, handling, freighting, transportation or insurance of the product or any part thereof or replacement of and do not extend to, and exclude, any damage or loss occurring by reason of, during, associated with, or related to such installation, de-installation, re-installation or transit.

Panasonic Authorised Service Centres are located in major metropolitan areas and most regional centres of Australia, however, coverage will vary dependant on product. For advice on exact Authorised Service Centre locations for your product, please telephone our Customer Care Centre on 132600 or visit our website and use the Service Centre Locator.

In addition to your rights under this warranty, Panasonic products come with consumer guarantees that cannot be excluded under the Australian Consumer Law. If there is a major failure with the product, you can reject the product and elect to have a refund or to have the product replaced or if you wish you may elect to keep the goods and be compensated for the drop in value of the goods. You are also entitled to have the product repaired or replaced if the product fails to be of acceptable quality and the failure does not amount to a major failure.

If there is a major failure in regard to the product which cannot be remedied then you must notify us within a reasonable period by contacting the Panasonic Customer Care Centre. If the failure in the product is not a major failure then Panasonic may choose to repair or replace the product and will do so in a reasonable period of time from receiving notice from you.

**THIS WARRANTY CARD AND THE PURCHASE DOCKET (OR SIMILAR PROOF OF PURCHASE)
SHOULD BE RETAINED BY THE CUSTOMER AT ALL TIMES**

If you require assistance regarding warranty conditions or any other enquiries, please visit the **Panasonic Australia** website www.panasonic.com.au or contact by phone on **132 600**
If working in, please ensure you have your operating instructions available.

Panasonic Australia Pty. Limited

ACN 001 592 187 ABN 83 001 592 187

1 Innovation Road, Macquarie Park NSW 2113

PRO-031-F11 Issue: 4.0

01-01-2011

For the United Kingdom and Ireland customers

Sales and Support Information

Customer Communications Centre

- For customers within the UK: 0844 844 3899
- For customers within Ireland: 01 289 8333
- Monday–Friday 9:00 am – 5:00 pm (Excluding public holidays).
- For further support on your product, please visit our website:
www.panasonic.co.uk

Direct Sales at Panasonic UK

- Order accessory and consumable items for your product with ease and confidence by phoning our Customer Communications Centre Monday–Friday 9:00 am – 5:00 pm (Excluding public holidays).
- Or go on line through our Internet Accessory ordering application at www.pas-europe.com.
- Most major credit and debit cards accepted.
- All enquiries transactions and distribution facilities are provided directly by Panasonic UK.
- It couldn't be simpler!
- Also available through our Internet is direct shopping for a wide range of finished products. Take a browse on our website for further details.

Manufactured by: Panasonic Corporation
Kadoma, Osaka, Japan

Importer for Europe: Panasonic Marketing Europe GmbH
Panasonic Testing Centre
Winsbergring 15, 22525 Hamburg, Germany



Panasonic Corporation
Web Site: <http://panasonic.net>

En

© Panasonic Corporation 2014



YOM2001630002

VQT5J42
F0314KE0