

# Shenley Extendable Table

Assembly Instructions - Please keep for future reference

392/2628

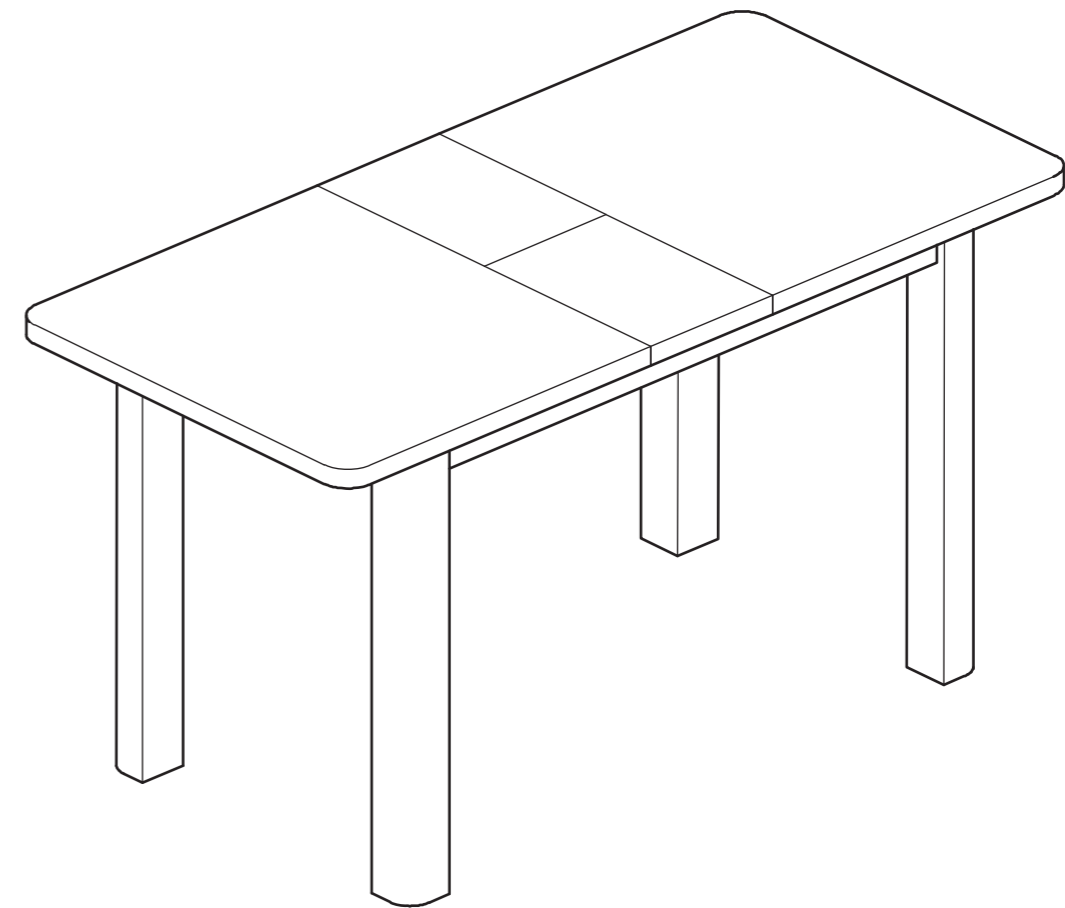

## Dimensions

Width - 150 (180)cm  
Depth - 90cm  
Height - 75cm

**Important** – Please read these instructions fully before starting assembly

If you need help or have damaged or missing parts, call the **Customer Helpline: 0345 640 0800**

# ! Safety and Care Advice

## Important – Please read these instructions fully before starting assembly

- Check you have all the components and tools listed on page 2 and 3.

- Remove all fittings from the plastic bags and separate them into their groups.

- Keep children and animals away from the work area, small parts could choke if swallowed.

- Make sure you have enough space to layout the parts before starting.

- During assembly do not stand or put weight on the product, this could cause damage.

- Assemble the item as close to its final position (in the same room) as possible.

- Assemble on a soft level surface to avoid damaging the unit or your floor.

- Parts of the assembly will be easier with 2 people.



- To reduce the likelihood of damaging your product please ensure that your

power drill is set on a low torque setting.

- Dispose of all packaging carefully and responsibly.

## Care and maintenance

- Only clean using a damp cloth and mild detergent, do not use bleach or abrasive cleaners.

- From time to time check that there are no loose screws on this unit.

- This product should not be discarded with household waste. Take to your local authority waste disposal centre.

## Handy Hints

- Assemble all parts and bolts loosely during assembly, only once the product is complete should you fully tighten the bolts.

- Regularly check and ensure that all bolts and fittings are tightened properly.

# Assembly Instructions

## Close table

**a:** Release safety locks (see safety lock instruction below) Hold the top of table to lift the table up and pull the table tops out as shown by the arrows.

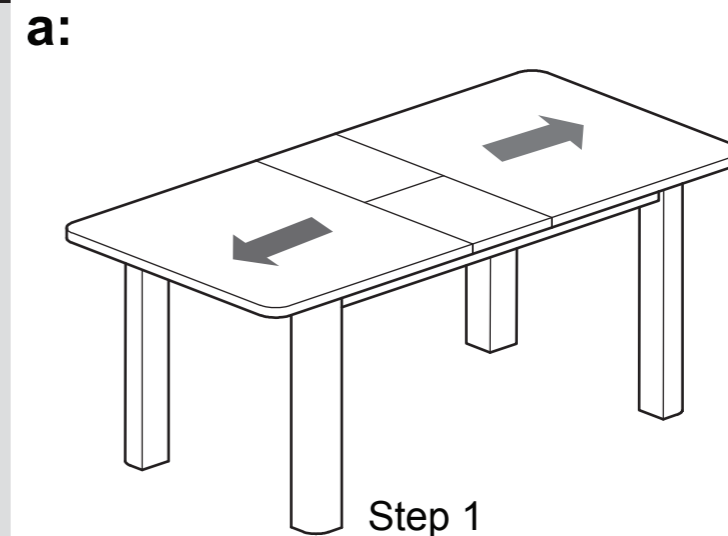

**b:** Close the extension leaves.

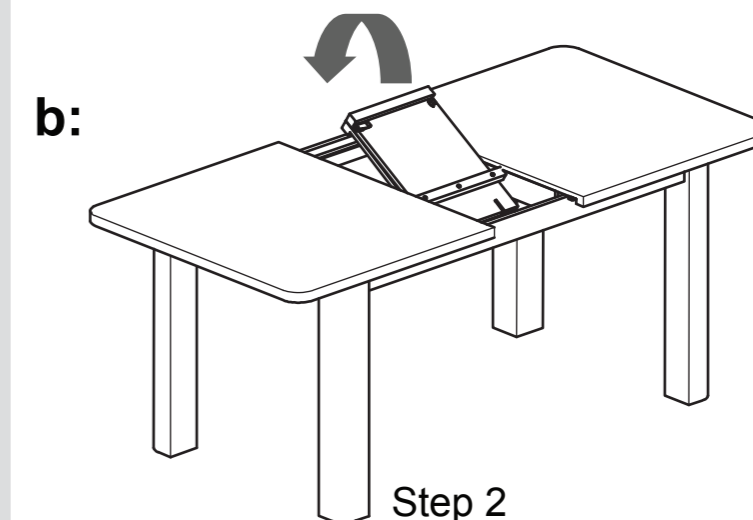

**c:** Hold the table top to push on both sides of tables as shown by the arrows. Use safety locks to ensure table tops will not move while using. (see safety lock instruction below)

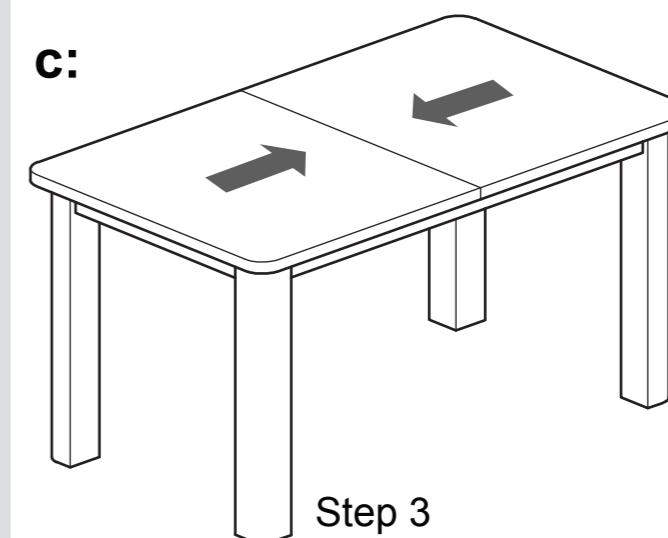

### SAFETY LOCK INSTRUCTION.

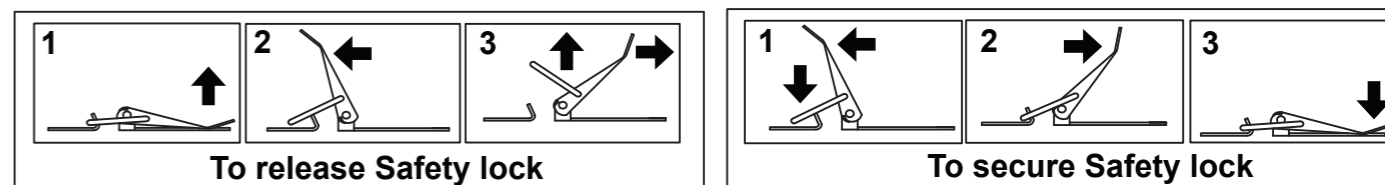

# Assembly Instructions

## Open table

**a:** Release safety locks (see safety lock instruction below) Hold the top of table to lift the table up and pull the table tops out as shown by the arrows.

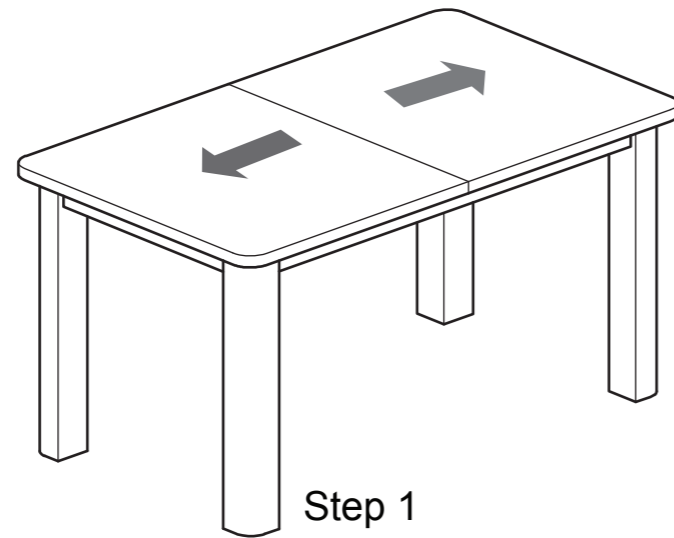

Step 1

**b:** Close the extension leaves.

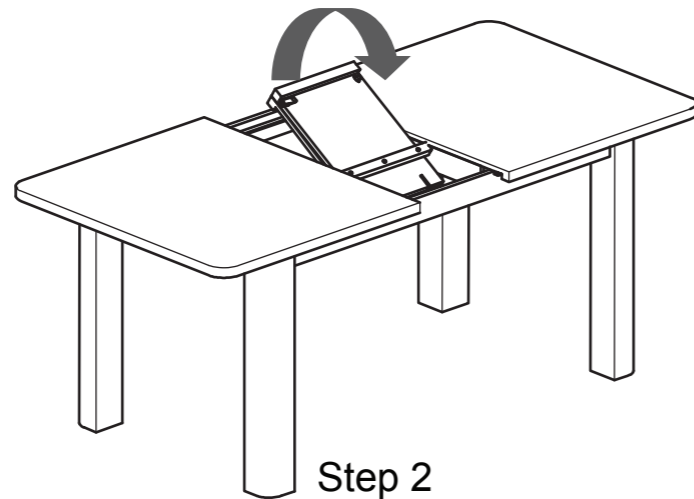

Step 2

**c:** Hold the top of table to push on both sides of tables as shown by the arrows. Use safety locks to ensure table tops will not move while using. (see safety lock instruction below)

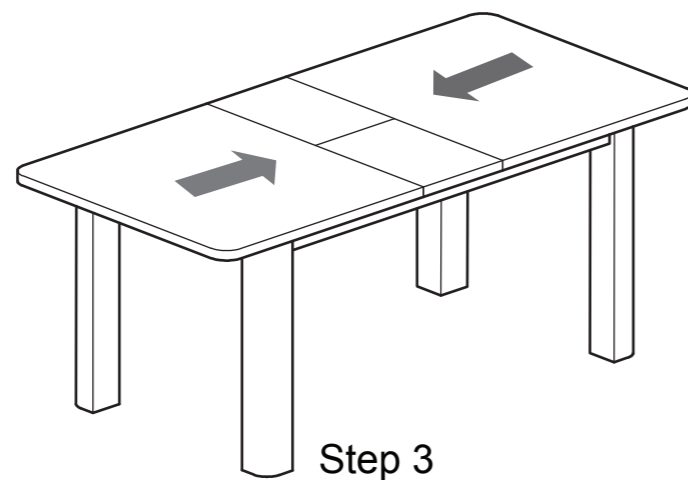

Step 3

# Components - Parts

If you have damaged or missing components, call the **Customer Helpline: 0345 640 0800**

Please check you have all the parts listed below

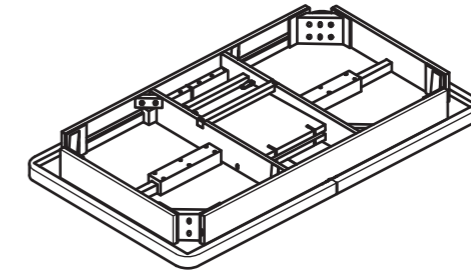

1 Table top x 1

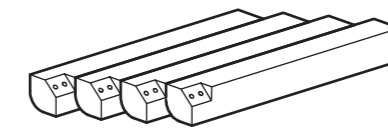

2 Leg x 4



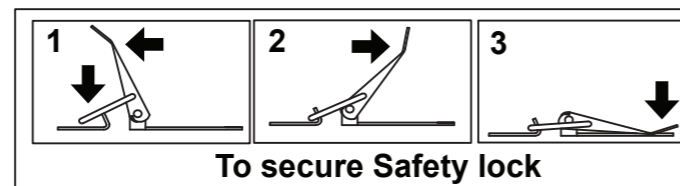

### SAFETY LOCK INSTRUCTION.

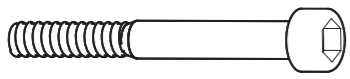

# Components - Fittings

Please check you have all the fittings listed below

**Note:** The quantities below are the correct amount to complete the assembly. In some cases more fittings may be supplied than are required.

<b>A</b>  Bolt x 8	<b>B</b>  Spring washer x 8	<b>C</b>  Washer x 8
<b>D</b>  Allen key x 1		

# Assembly Instructions

## Step 1

Place table top upside down being careful not to scratch the table top (lift the product within its cardboard packaging will assist you being able to do this)

**a:** Attach the legs **2** (x4) to each of the corners, by first step insert spring washers **B** and washers **C** into all the bolts **A**. Then screw the bolts **A** through the corner blocks and into the holes in the legs **2**. Tighten bolts by using the allen key **D**.

**Fully tighten all bolts.**

**b:** 2 people are required for this next stage.

Turn the table upright and place on desired location.

**Assembly is complete.**

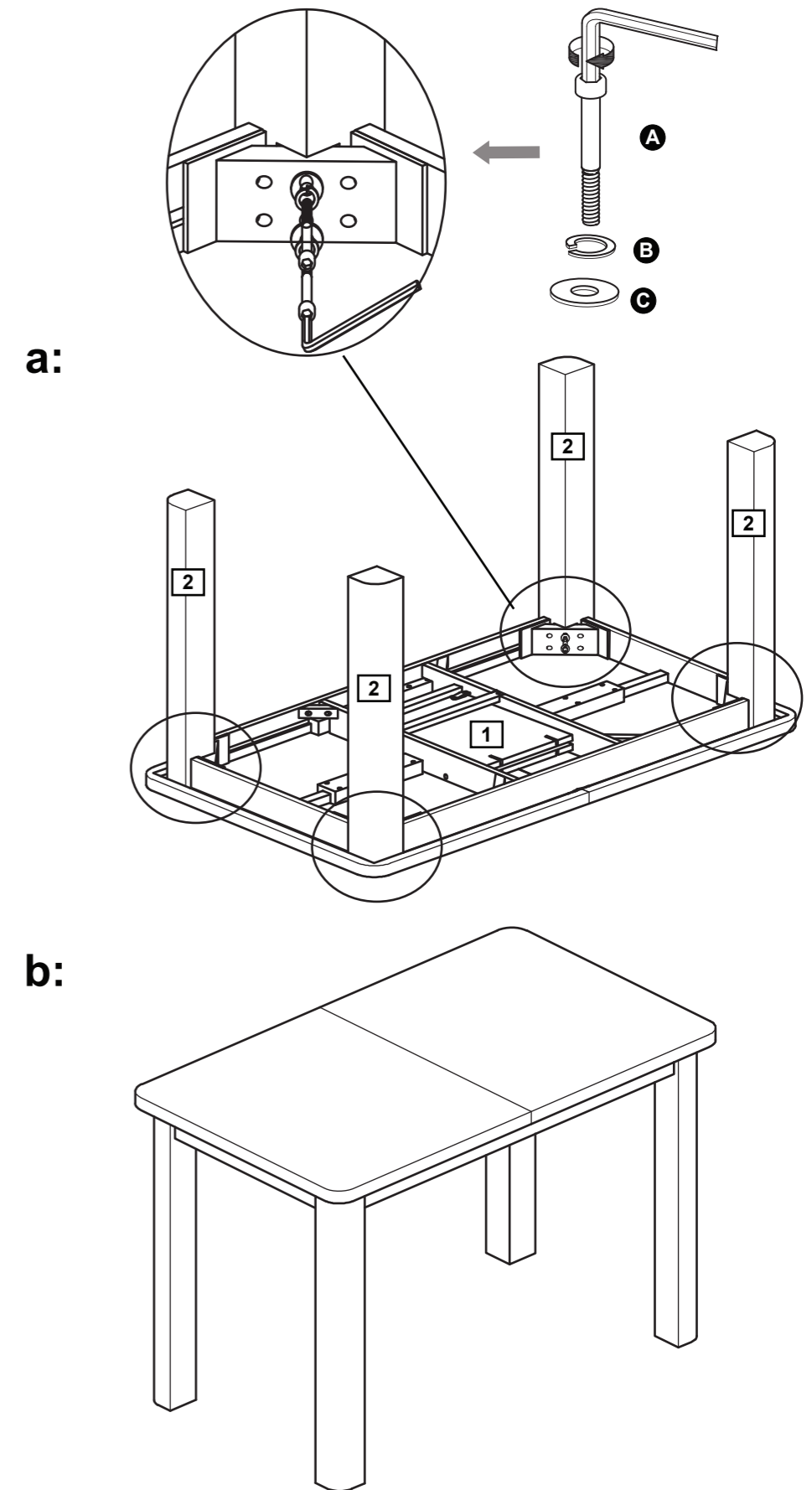

If you need help or have damaged or missing parts, call the **Customer Helpline: 0345 640 0800**

# Dining Chair

Assembly Instructions - Please keep for future reference

603/4135

603/2333

603/2900

133/6948

602/9834

603/2364

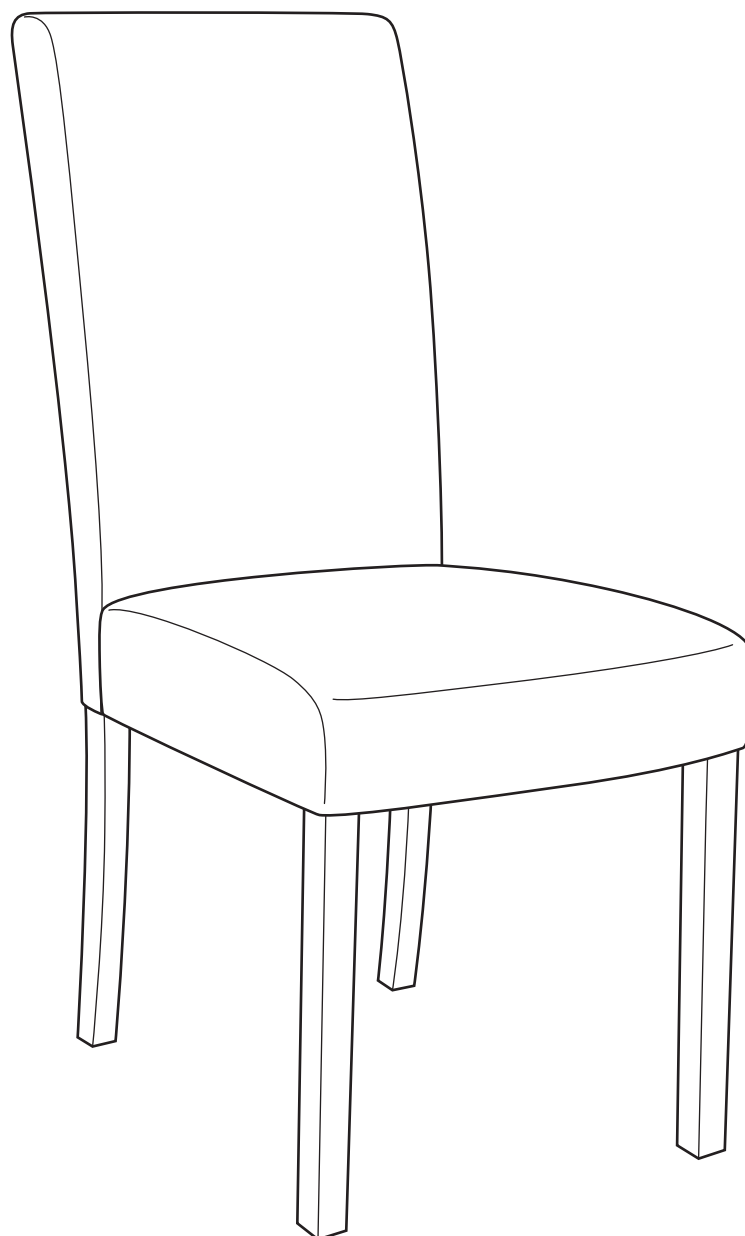

## Dimensions

Width - 44cm

Depth - 54cm

Height - 92cm

**Important - Please read these instructions fully before starting assembly**

If you need help or have damaged or missing parts, call the **Customer Helpline: 08456 400800**



# Safety and Care Advice

## Important - Please read these instructions fully before starting assembly

- Assemble this product on a flat surface.
- Assemble all parts loosely before tightening any bolts.
- Do not discard any of the packaging until you have checked that you have all the parts and the pack of fittings.

- Discard all extra fittings and keep fittings out of reach of children.
- Unit weight: 4.9kgs.
- Maximum safe weight of user: 110kgs.
- Retain Assembly Instructions for future reference.



- We do not recommend the use of power drill/drivers **for inserting screws**, as this could damage the unit. Only use hand screwdrivers.
- Dispose of all packaging carefully and responsibly.

## Warnings

- This product should only be used on firm, level ground.
- Make sure the legs remain in contact with the ground.
- Do not stand on the product.

## Care and maintenance

- Please clean the product using either damp (not wet) cloth and a mild domestic soap solution or by using an appropriate polish.
- Do not use any abrasive materials when cleaning.
- From time to time check that there are no loose bolts on this unit.

# Components - Parts

If you have damaged or missing components, call the **Customer Helpline: 08456 400800**

Please check you have all the parts listed below

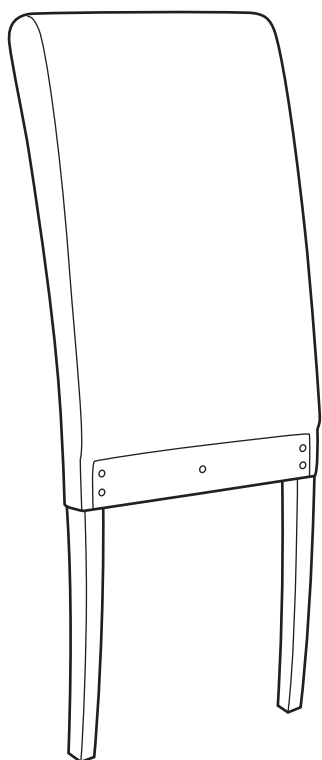

**1** Backrest  
(36 x 10 x 92cm)

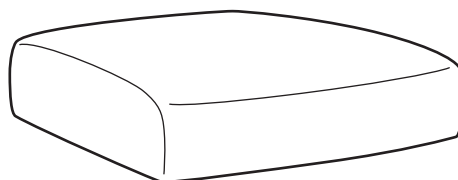

**2** Seat  
(43.5 x 41 x 9.5cm)

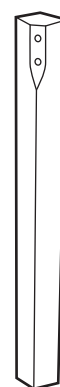

**3** Leg x 2  
(3 x 3 x 43cm)

# Components - Fittings

Please check you have all the fittings listed below

**Note:** The quantities below are the correct amount to complete the assembly. In some cases more fittings may be supplied than are required.

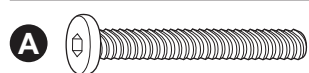

M6 x 50mm Bolt x 9



Spring washer x 9



Flat washer x 9



Allen key x 1

**Ruler** - Use this ruler to help correctly identify the screws

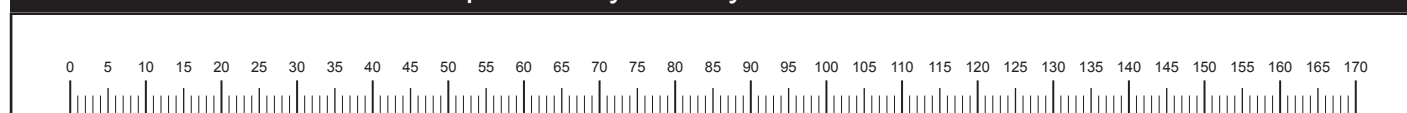

# Assembly Instructions

## Step 1

### Attaching legs

Place the seat **2** upside down on a flat protected surface.

Insert the legs **3** into the holes of the seat as shown and fix using bolts **A**, spring washers **B** and washers **C**.



**Important:**

Fasten bolts using allen key **D** but do not fully tighten at this stage.

**Note:**

Use oval head of allen key **D** on tight angles.

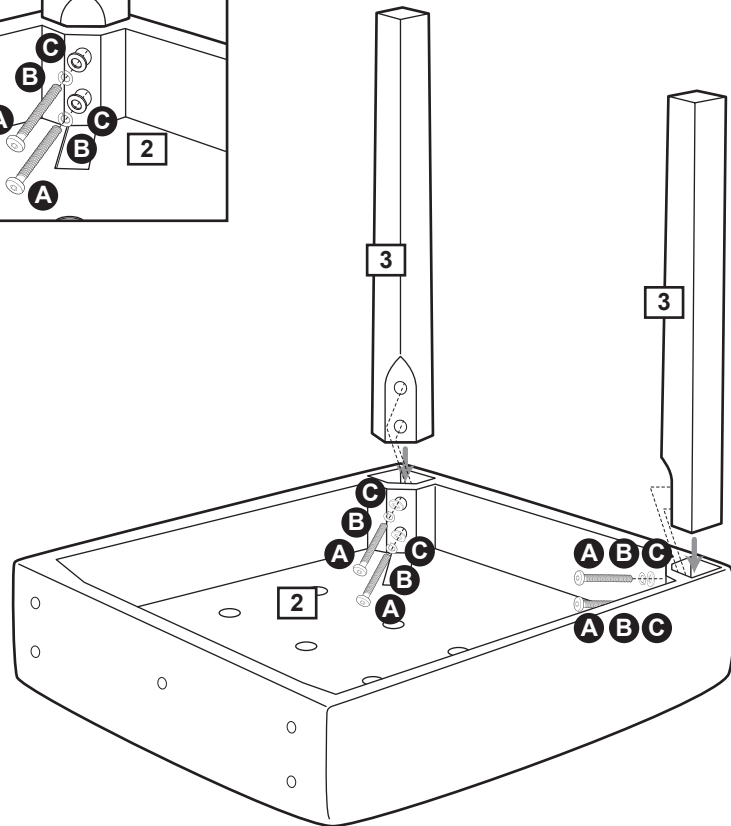
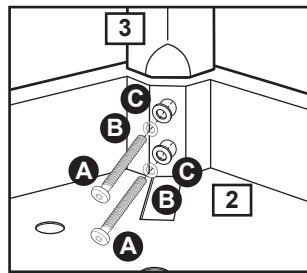

## Step 2

### Attaching backrest

Place the backrest on a flat protected surface.

Position the seat **2** on the backrest **1** as shown and fix using bolts **A**, spring washers **B** and washers **C**.



**Important:**

Fasten bolts using allen key **D** but do not fully tighten at this stage.

**Note:**

Use oval head of allen key **D** on tight angles.

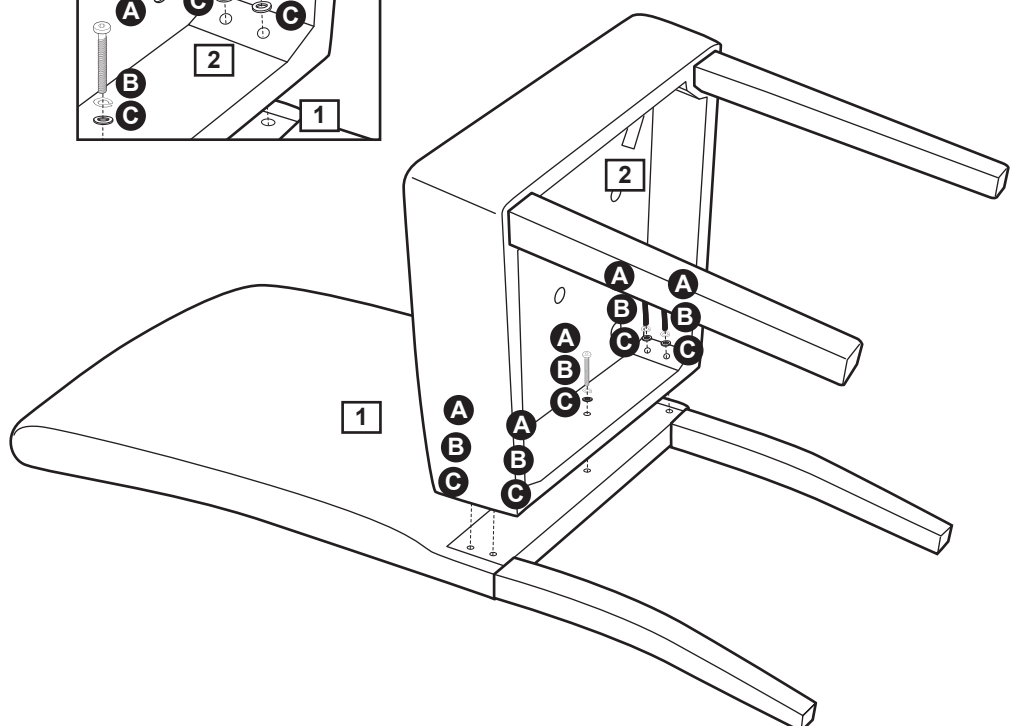
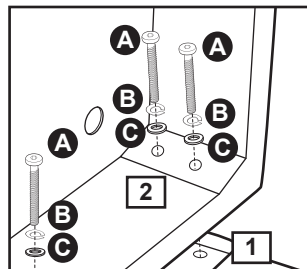



# Assembly Instructions

## Step 3

### Aligning & securing the legs

Carefully turn the chair upright and place on a flat surface.

**a:** Tighten all bolts using allen key **D**.

**Note:**

Use oval head of allen key **D** on tight angles.

**Note:** This step is essential to prevent the chair from wobbling due to uneven legs.

**b:** Carefully sit on the chair and make adjustments to ensure the legs are flat even on the floor.

**c:** After the sitting test, re-tighten bolts again if any adjustment is needed.

**Note:** It is highly recommended to re-tighten all bolts after using the chair for 7 days.

**Note:** Keep allen key to re-tighten bolts when required.

**Assembly is complete.**

**a:**

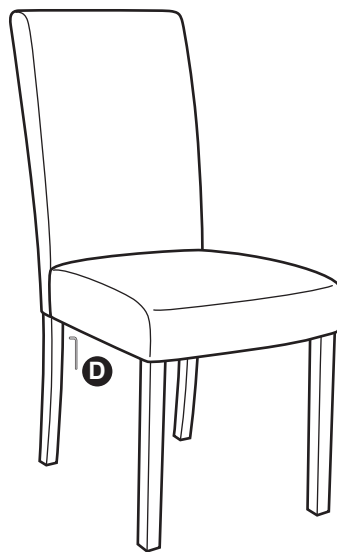

**b:**

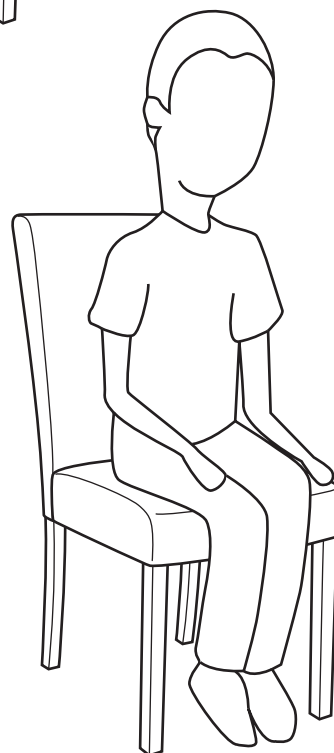

**c:**

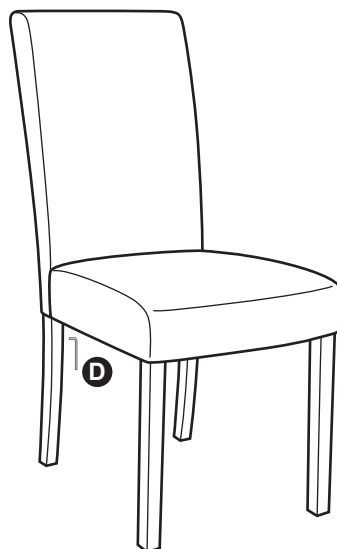

If you need help or have damaged or missing parts, call the **Customer Helpline: 08456 400800**