

Shark®

Rocket®

POWERHEAD

Model

AH450UK

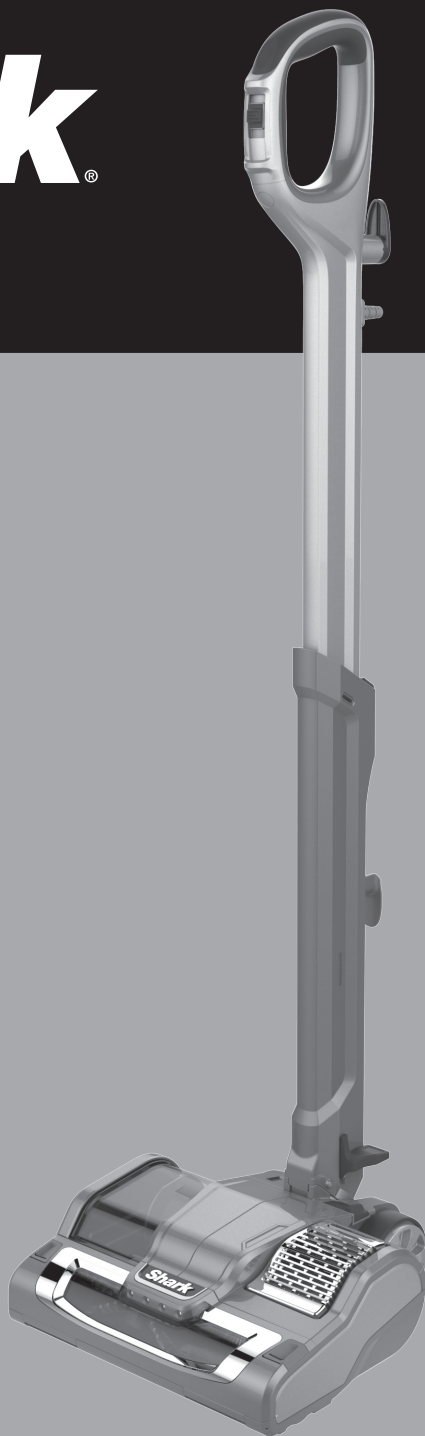

www.sharkclean.eu



0800 862 0453

Contents

Getting to Know Your Shark® Rocket® Powerhead Vacuum	3
Assembly	4
Selecting the Correct Brushroll	4
Usage	5
Suction Release	5
Vacuuming	6
Storage	6
Maintenance	7
Emptying the Dust Cup	7
Cleaning the Filters	7
Cleaning the Powerhead	8
Troubleshooting Guide	9
Warranty	10

Thank you for
purchasing the
Shark® Rocket®
Powerhead.
AH450UK

TECHNICAL SPECIFICATIONS:

Voltage: 220-240V, 50/60Hz
Watts: 600W

This appliance complies with the WEEE-Directive 2012/19/EU on the disposal of electrical and electronic equipment (WEEE).



This marking indicates that this product should not be disposed with other household wastes throughout the EU. To prevent possible harm to the environment or human health from uncontrolled waste disposal, recycle it responsibly to promote the sustainable reuse of material sources. To return your used device, please use the return and collection systems or contact the retailer where this product was purchased. They can take this product for environmental safe recycling.

This appliance complies with the European directives for electromagnetic compatibility (EMC) 2004/108/EC and its revisions, as well as Low Voltage Directive (LVD) 2006/95/EC and its revisions.



IMPORTANT SAFEGUARDS

When using an electrical appliance, basic safety precautions should always be observed, including the following:

WARNING

This appliance is not intended for use by persons with reduced physical, sensory or mental capabilities, or lack of experience and knowledge, unless they have been given supervision or instruction concerning use of the appliance by a person responsible for their safety.

Children shall not use or play with this appliance. Close supervision is necessary to keep appliance out of reach of children during use.

CAUTION

THE MOTORISED POWER NOZZLE, AND HANDLE CONTAIN ELECTRICAL CONNECTIONS:

- These are not serviceable parts.
- Do not use to vacuum any liquids.
- Do not immerse in water when cleaning.
- Prior to use, inspect for damage. Discontinue using if damaged.

WARNING

TO REDUCE THE RISK OF FIRE, ELECTRIC SHOCK OR INJURY:

- 1 DO NOT use outdoors or on wet surfaces.
- 2 Unplug from plug socket when not in use and before servicing.
- 3 Inspect power cord or plug for any damage before use. DO NOT use vacuum cleaner with a damaged cord or plug.
- 4 DO NOT use if the appliance is not working, has been dropped, dropped into water, damaged or left outdoors.
- 5 NO SERVICEABLE PARTS. Incorrect re-assembly or repair can cause a risk of electrical shock or injury to persons when the appliance is used. Contact Customer Service.
- 5 DO NOT pull or carry vacuum cleaner by the cord or use the cord as a handle.
- 6 DO NOT unplug by pulling on cord; to unplug, grasp the plug, not the cord.
- 7 DO NOT handle plug or vacuum cleaner with wet hands.
- 8 DO NOT run the vacuum cleaner over the power cord, close a door on the cord or pull cord around sharp corners.
- 9 The use of an extension cord is not recommended.
- 10 DO NOT leave vacuum cleaner when plugged in.
- 11 Keep cord away from heated surfaces.
- 12 Turn off all controls before plugging or unplugging the vacuum cleaner.
- 13 Store your vacuum cleaner with the power cord secured around the two cord holders as shown in the STORAGE section.
- 14 DO NOT attempt to defeat the interlocks.

GENERAL USE

- 15 Use only as described in this manual.
- 16 DO NOT put any objects into openings. DO NOT use with any opening blocked; keep free of dust, lint, hair, and anything that may reduce airflow.
- 17 Keep your work area well lit.
- 18 Keep the vacuum cleaner moving over the carpet surface at all times to avoid damaging the carpet fibers.
- 19 DO NOT place vacuum cleaner on unstable surfaces such as chairs or tables.
- 20 DO NOT allow young children to operate the vacuum cleaner or use as a toy. Close attention is necessary when used near children.
- 21 DO NOT use without Dust Cup and/or filters in place.
- 22 DO NOT use if airflow is restricted; if the air paths or the Motorised Floor Nozzle become blocked, turn the vacuum cleaner off. Remove all obstructions before you turn on the unit again.
- 23 Keep Motorised Floor Nozzle away from hair, face, fingers, uncovered feet, and loose clothing.
- 24 Only use manufacturer's recommended attachments.

DUST CUP/FILTERS

Before turning on the vacuum:

- 25 Make sure that all filters are thoroughly dry after routine cleaning.
- 26 Make sure that Dust Cup and all filters are in place after routine maintenance. Refer to MAINTENANCE section for filter cleaning instructions.
- 27 Make sure Motorised Floor Nozzle is free of blockages.
- 28 Only use filters and accessories provided by EURO-PRO Operating LLC. [Failure to do so will void the warranty.]

GENERAL CLEANING

- 29 DO NOT pick up large-sized objects.
- 30 DO NOT pick up hard or sharp objects such as glass, nails, screws, or coins that could damage the vacuum cleaner.
- 31 DO NOT use to pick up drywall dust.
- 32 DO NOT pick up smoking or burning objects such as hot coals, cigarette butts, fireplace ash, or matches.
- 33 DO NOT pick up flammable or combustible materials such as lighter fluid, gasoline, or kerosene or use vacuum in areas where they may be present.
- 34 DO NOT pick up toxic solutions such as chlorine bleach, ammonia, or drain cleaner.
- 35 DO NOT use in an enclosed space where vapors are present from paint, paint thinner, moth-proofing substances, flammable dust, or other explosive or toxic materials.
- 36 DO NOT vacuum up any liquids.
- 37 DO NOT immerse vacuum cleaner in water or other liquids.
- 38 DO NOT use outdoors or on wet surfaces; use only on dry surfaces.
- 39 Use extra care when cleaning on stairs.
- 40 Remove brushroll from unit before rinsing.

SAVE THESE INSTRUCTIONS

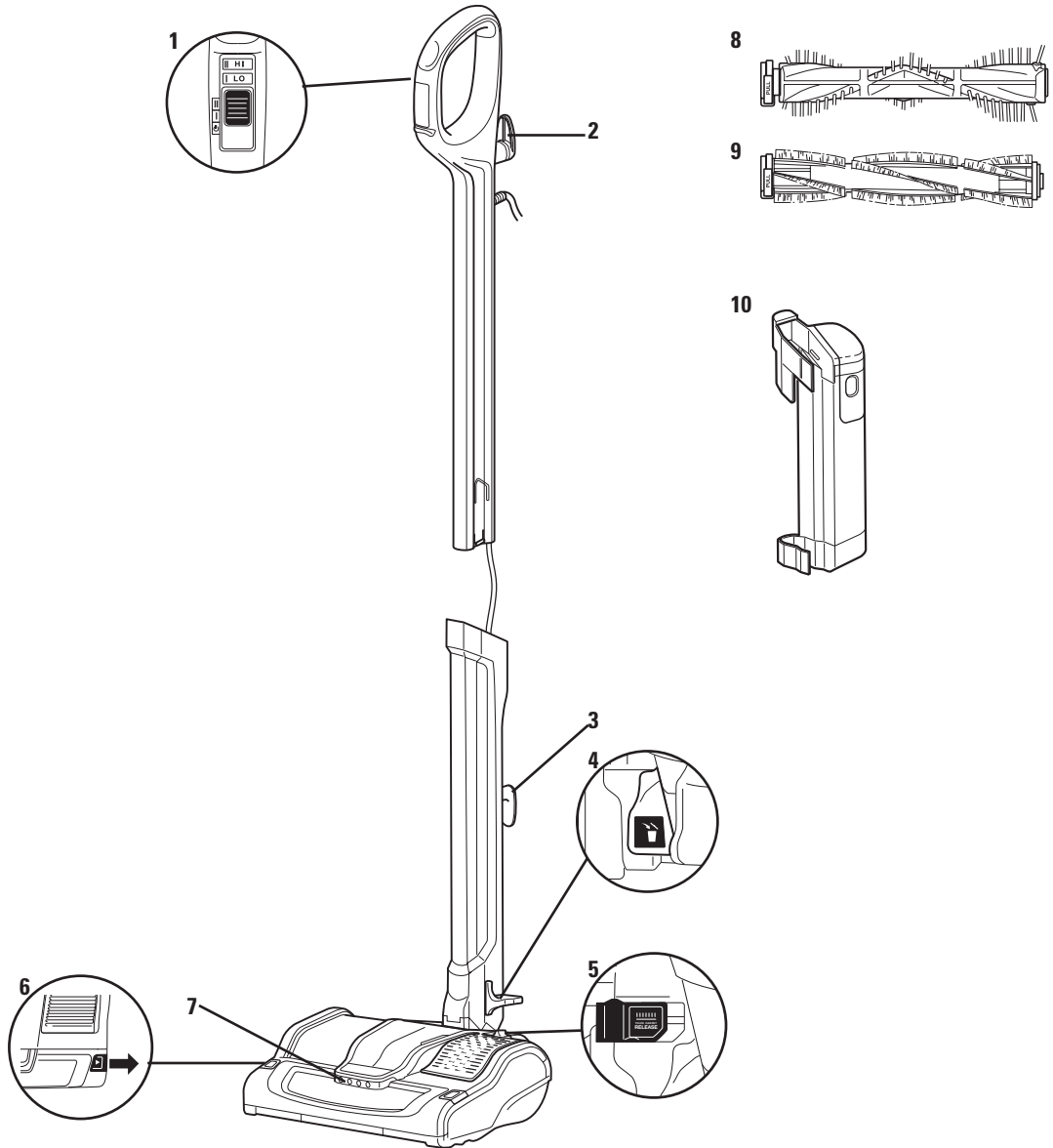

MAIN UNIT

- 1 Power/LO/HI Switch
- 2 Upper Cord Hook
- 3 Lower Cord Hook

- 4 Dust Cup Release Foot Pedal
- 5 Suction Release
- 6 Brushroll Cover Release
- 7 Headlights

ACCESSORIES

- 8 Deep Clean Carpet Brushroll
- 9 Gentle Touch Hard Floor Brushroll
- 10 Brushroll Holster



ASSEMBLY

STEP 1

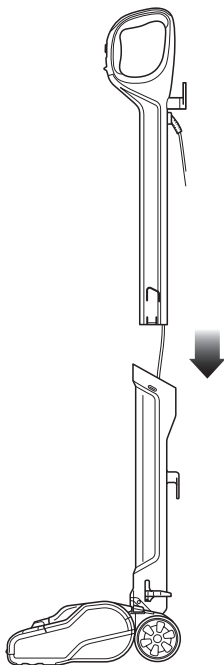

STEP 2

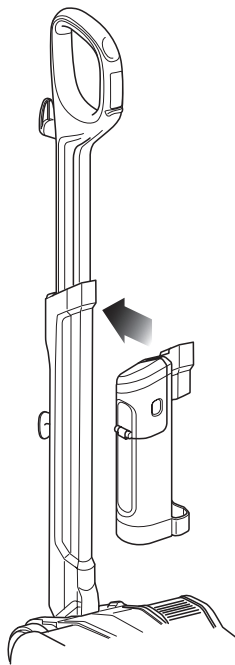

STEP 3

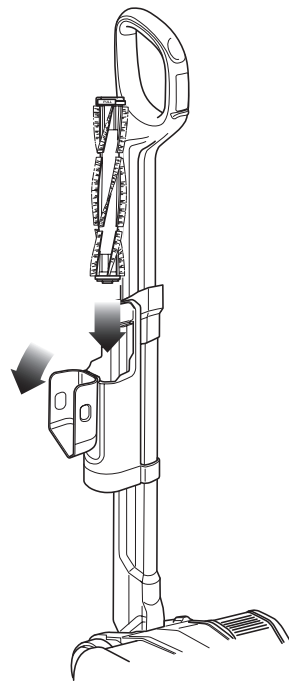

IMPORTANT: Always inspect wires for damage before assembly.

- 1** Insert the upper part of the Wand into the lower portion. Make sure not to pinch the wires.
Push the two parts together until you hear them click in place.
- 2** Push the Brushroll Holster onto the lower part of the wand until you hear it click into place.
- 3** Open the top of the Brushroll Holster and insert the spare Brushroll. Close before using vacuum.

SELECTING THE CORRECT BRUSHROLL

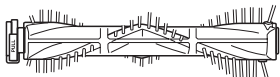

Deep Clean Carpet Brushroll

3171FFJ450UK

The Deep Clean Carpet Brushroll can be used on all floor types. It is optimised for deep carpet cleaning.

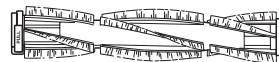

Gentle Touch Hard Floor Brushroll

3173FFJ450K

Use this Brushroll for enhanced hard-floor cleaning.

USAGE

The Shark® Rocket® Powerhead has a 2-speed POWER slider switch on the handle.

The Motorised Floor Nozzle is equipped with headlights that illuminate the floor surface being cleaned. The lights turn on in either speed setting.

LO

Brushroll spins slowly

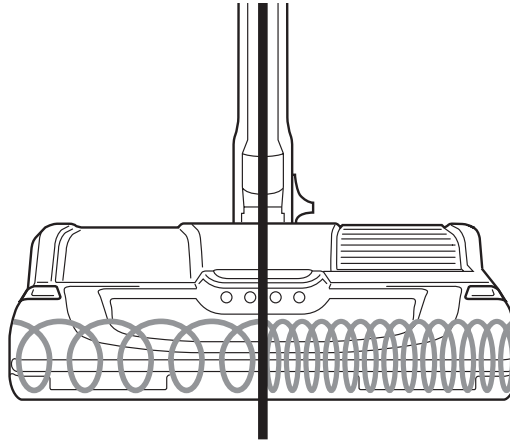
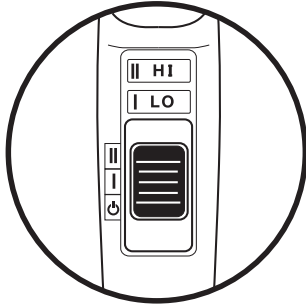

HI

Brushroll spins quickly

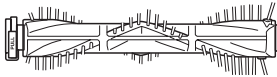
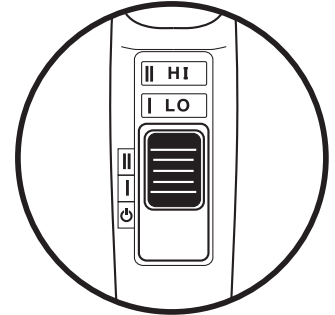

Deep Clean Carpet Brushroll

- **LO** - Gentle on hard floors and area rugs
- **HI** - Cleans carpets by removing embedded dirt

- 1 Plug the unit into a plug socket.
- 2 Slide the POWER switch to the LO position to gently clean hard floors and area rugs. The Brushroll will spin slowly.
- 3 Slide the POWER switch to the HI position to deep-clean carpets by removing embedded dirt. The Brushroll will spin quickly.

NOTE: Before vacuuming your delicate area rugs or carpets, refer to the manufacturer's recommended cleaning instructions.



Gentle Touch Hard Floor Brushroll

- **LO** - For large and heavy debris pickup
- **HI** - For loose and stuck-on dust and debris

- 1 Plug the unit into a plug socket.
- 2 Slide the POWER switch to the LO position to clean large and heavy debris. The Brushroll will spin slowly.
- 3 Slide the POWER switch to the HI position to clean loose and stuck-on dust and debris. The Brushroll will spin quickly.

NOTE: The brushroll will not spin unless the Wand is reclined.

SUCTION RELEASE

This unit has a Suction Control Button to help with push and pull on high-pile carpets and to release suction when vacuuming area rugs. Open to minimise suction. Be sure to close again for maximum suction.

Less Suction

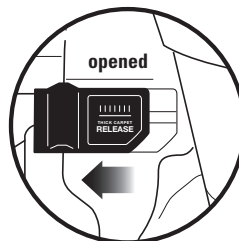

More Suction

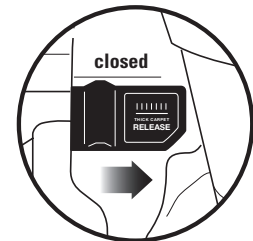

VACUUMING

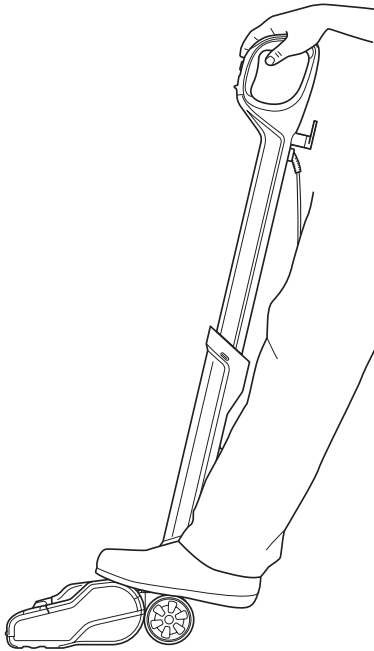

- 1 Stand the vacuum upright. Step on the Motorised Floor Nozzle and pull the Wand back to start vacuuming.

STORAGE

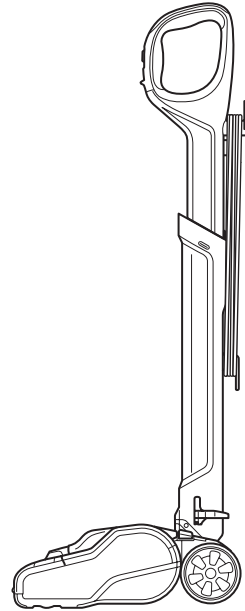

- 1 Wrap the power cord around the cord hooks.

MAINTENANCE

To keep your vacuum's suction power optimal, follow these instructions.

IMPORTANT: Allow ALL filters to dry completely before replacing in the vacuum.

Make sure unit is off and cord is unplugged.

STEP 1

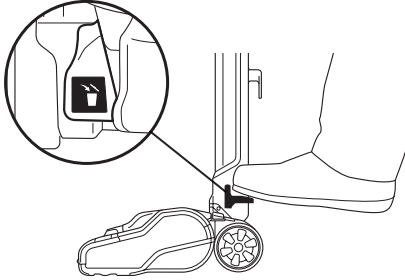

STEP 2

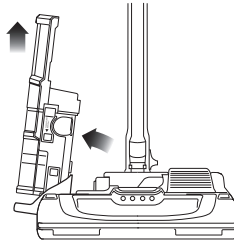

STEP 3

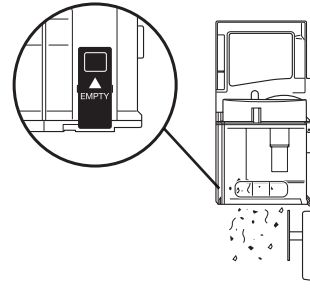

EMPTYING THE DUST CUP

- 1 Detach the removable Dust Cup from the Motorised Floor Nozzle by pressing the Dust Cup Release Foot Pedal located on the left side near the nozzle.
- 2 Holding the Dust Cup by the handle, lift it up to remove it from the Motorised Floor Nozzle.
- 3 Hold the Dust Cup over a rubbish bin, then press the Empty button on the side of the Dust Cup. The bottom lid will open, allowing the debris to fall out.
- 4 Clean the dust screen inside the Dust Cup as required.

Pre-Motor Filters

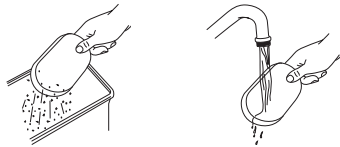
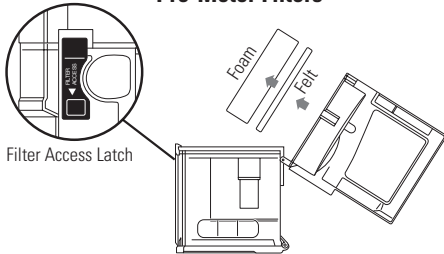

Post-Motor Filter

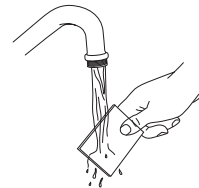
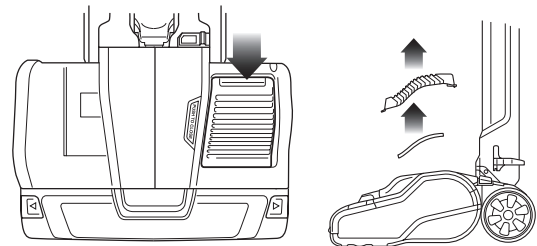

CLEANING THE FILTERS

Pre-Motor Filters

- 5 Access the Pre-Motor Filters by pressing the FILTER ACCESS latch on the top of the Dust Cup. Remove and rinse the foam and felt filters **every month**. Let air-dry **COMPLETELY** before replacing in the vacuum. Hand wash only. Tap loose dirt off filters between washes as needed. Insert the felt filter first, and then place the foam filter on top of it.

Post-Motor Filter

- 6 Access the Post-Motor Filter on the top of the Motorised Floor Nozzle. Remove and rinse **once a year**. Let air-dry completely before replacing. Hand wash only.

RECOMMENDED FILTER CLEANING SCHEDULE:

Pre-Motor Filter Kit (Foam & Felt):	XFFH400	Every month
Post-Motor Filter:	XEXFH400	Every year



IMPORTANT: Remove Brushroll from unit before rinsing.

IMPORTANT: Make sure Brushrolls are completely dry before replacing in the vacuum.

Make sure unit is off and cord is unplugged.

STEP 1

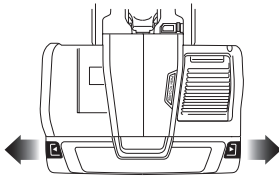

STEP 2

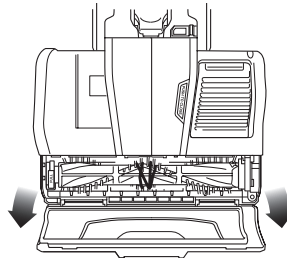

STEP 3

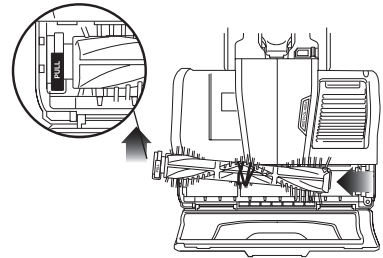

STEP 4

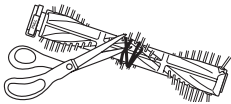

STEP 5

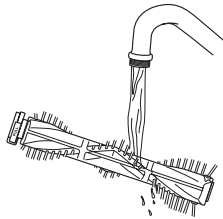

STEP 6

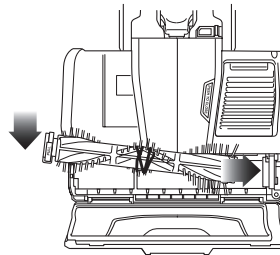

STEP 7

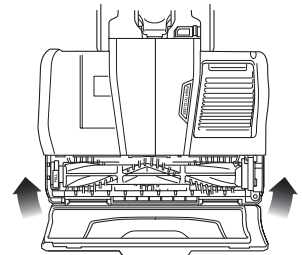

CLEANING THE POWERHEAD

TO ACCESS THE BRUSHROLL

- 1 Slide the Brushroll Cover Release Buttons out.
- 2 Pull up to open the hood of the Motorised Floor Nozzle.
- 3 Lift the tab on the Brushroll up to remove it from the Motorised Floor Nozzle.
- 4 Remove any string, carpet fibers, or hair that is wrapped around the Brushroll. The groove on the Brushroll allows a pair of scissors to cut the debris without damaging the bristles.

- 5 The Brushroll can be removed and rinsed under running water. Let the Brushroll air-dry completely before replacing in the Motorised Floor Nozzle.
- 6 To reassemble, hold the Brushroll by the tab and align the other end with the gear. Then with the tab facing up, place the Brushroll in the Motorised Floor Nozzle.
- 7 Close the Brushroll cover. Listen for a click and make sure the release buttons are fully closed.

IMPORTANT: DO NOT place the Brushroll in the dishwasher to wash or the dryer to dry. DO NOT submerge the Brushroll in water.

IMPORTANT: Using a wet Brushroll in the Motorised Floor Nozzle **will void your warranty.**

TROUBLESHOOTING GUIDE

Customer Service: 0800 862 0453

Vacuum is not picking up dirt. No suction or light suction.

- Check filters to see if they need cleaning. Follow instructions for rinsing and completely air-drying the filters before re-inserting into the vacuum.
- Dust Cup may be full; empty Dust Cup.
- Check Motorised Floor Nozzle for blockages; clear blockages if required.
- Remove any string, carpet fibers, or hair that may be wrapped around the Brushroll.

Vacuum lifts area rugs.

- Suction is powerful. Take care when vacuuming area rugs or rugs with delicately sewn edges.
- Turn off the unit to disengage the Brushroll and restart with the POWER slider switch.
- Open the Suction Control Button on the Motorised Floor Nozzle to decrease suction power.

What does the brushroll indicator light mean?

- Solid Green: The brushroll is on and working as it should.
- Solid Red: There is a jam in the brushroll area. Turn your vacuum off and remove the blockage.
- Flashing Red: The motorised floor nozzle is overheating. Turn your vacuum off and wait for it to cool down.

Brushroll does not spin.

- If Brushroll Indicator Light on the Motorised Floor Nozzle turns red, the Brushroll has stopped spinning. Immediately turn off, unplug vacuum and remove blockage. Replace the power plug into the plug socket and turn the vacuum on.
- If Brushroll Indicator Light on the Motorised Floor Nozzle is green, the blockage has been successfully cleared. If the light is still red, please contact customer service at 0800 862 0453.
- Check to make sure the Brushroll was replaced correctly if it had been removed.
- Make sure that the 2-speed POWER slider switch on the handle is properly set to the desired floor setting.
- Ensure hood of the Motorised Floor Nozzle is closed completely.

Brushroll access hood will not close.

- Make sure that the Brushroll was reinserted correctly with the pull tab facing up.

Dust Cup will not latch back onto Motorised Floor Nozzle.

- Make sure both the bottom door and filter access are fully closed. Press firmly in the center of the Dust Cup on the Motorised Floor Nozzle until you hear a click.

Vacuum turns off on its own or the indicator light flashes red.

- This vacuum is equipped with a motor protective thermostat so the vacuum will shut off if it overheats. Should this occur, perform the following steps to restart the motor thermostat:
 1. Turn the unit off.
 2. Unplug the vacuum.
 3. Empty the Dust Cup and clean filters.
 4. Check for blockages in tube, accessories and inlet openings.
 5. Allow the unit to cool for a minimum of 45 minutes.
 6. Plug in the vacuum.
 7. Restart the unit by turning the POWER slider switch on.



WARRANTY TERMS AND CONDITIONS

When a consumer buys a product in the UK, they get the benefit of legal rights relating to the quality of the product (your “statutory rights”). You can enforce these rights against your retailer. However, at Shark we are so confident about the quality of our products that we give you an additional manufacturer’s warranty of up to five years. These terms and conditions relate to our manufacturer’s warranty only – your statutory rights are unaffected.

The conditions below describe the prerequisites and scope of our warranty. They do not affect your statutory rights or the obligations of your retailer and your contract with them.

Shark® Guarantees

A household appliance like a vacuum cleaner constitutes a sizeable investment. Your new machine needs to work properly for as long as possible. The guarantee it comes with is an important consideration - and reflects how much confidence the manufacturer has in its product and manufacturing quality.

Every Shark® machine comes with a free parts and labour guarantee. Our customer service helpline (**0800 862 0453**) is open from 9.00am to 6.00pm Monday - Friday. It's free to call, and you'll be put straight through to a Shark representative. You'll also find online support at www.sharkclean.eu/uk.

How do I register my extended Shark® guarantee?

You can register your guarantee online within 28 days of purchase. To save time, you'll need the following information about your machine:

- Serial number (on the machine rating label)
- Date you purchased the machine (receipt or delivery note)
- To register online, please visit www.sharkclean.eu/uk/register-guarantee

IMPORTANT

- Both the 12 months and the extended 2 years guarantee will only cover your product from the date of purchase.
- Please keep your receipt at all times. Should you need to use your extended guarantee we will need your receipt to verify the information you have supplied to us is correct. The inability to produce a valid receipt may invalidate your guarantee.

What are the benefits of registering my free Shark® guarantee?

When you register your guarantee we'll have your details to hand if we ever need to get in touch. You can also receive tips and advice on how to get the best out of your Shark® vacuum and hear the latest news about new Shark® technology and launches.

If you register your guarantee online, you'll get instant confirmation that we've received your details.

How long are new Shark® machines guaranteed for?

Our confidence in our design and quality control means that your new Shark® vacuum cleaner is guaranteed for a total of three years. (12 months plus an extended warranty of 2 years).

What is covered by the free Shark® guarantee?

Repair or replacement of your Shark® machine (at Shark®'s discretion), including all parts and labour. A Shark® guarantee is in addition to your legal rights as a consumer.

What is not covered by the free Shark® guarantee?

- Blockages – For details of how to unblock your vacuum cleaner, please refer to the Operating Manual.
- Normal wear and tear such as brush bar, fuse, belt, batteries etc.
- Accidental damage, faults caused by negligent use or care, misuse, neglect, careless operation or handling of the vacuum cleaner which is not in accordance with the Shark® Operating Manual supplied with your machine.
- Use of the vacuum cleaner for anything other than normal domestic household purposes.
- Use of parts not assembled or installed in accordance with the operating instructions.
- Use of parts and accessories which are not Shark® Genuine Components.
- Faulty installation (except where installed by Shark®).
- Repairs or alterations carried out by parties other than Shark or its agents.

What happens when my guarantee runs out?

Shark® does not design products to last for a limited time. We do appreciate that there may be a desire for our customers to want to repair their vacuum cleaners after the warranty has elapsed. In this case please contact our free phone customer service help line and ask about our out warranty program, on **0800 862 0453**.

Where can I buy genuine Shark® spares and accessories?

Shark® spares and accessories are developed by the same engineers who developed your Shark® vacuum. You'll find a full range of Shark® spares and replacement parts for all Shark® machines at www.sharkclean.eu/uk/parts. Accessories are at www.sharkclean.eu/uk/accessories.

Please remember that using non-Shark® spares invalidates your guarantee.

Euro-Pro, Rocket and Shark are registered trademarks of Euro-Pro Operating LLC.

Shark®

Euro-Pro Europe Limited
15 Mariner Court
Calder Park
Wakefield
WF4 3FL
Freephone 0800 862 0453
www.sharkclean.eu



AH450UK_26_IB_150715_1

© 2015 Euro-Pro Operating LLC

Illustrations may differ from actual product. We are constantly striving to improve our products, therefore the specifications contained herein are subject to change without notice.

Printed in China



www.sharkclean.eu



0800 862 0453