

For
PS4™ | PS3™ | Mobile Gaming

EAR FORCE™
S T E A L T H
S C O P

TURTLE
BEACH



STEALTH
SCOP

7.1 SURROUND SOUND GAMING HEADSET

USER GUIDE



dts
HEADPHONE



**7.1 SURROUND
SOUND GAMING HEADSET**



Congratulations on your purchase of the Ear Force® Stealth 500P headset from Turtle Beach. Designed for PS3™, PS4™ and PS Vita™ gaming, the STEALTH 500P also supports music, movies, and chat. Turtle Beach brings over 35 years of expertise to transforming your listening experience.

In the Box

For our Knowledgebase and Technical Support please visit turtlebeach.com/support

A



Stealth 500P Headset

B

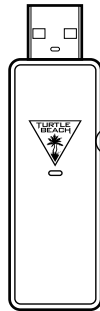

Stealth 500P Wireless Transmitter

C

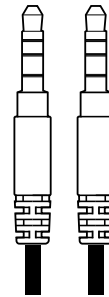

Mobile Cable

D

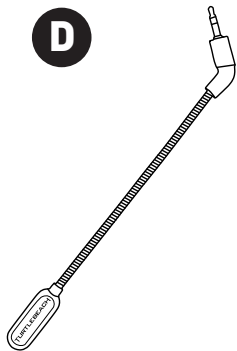

Removable Mic Boom

E

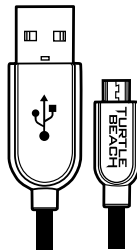

USB Charging Cable

F

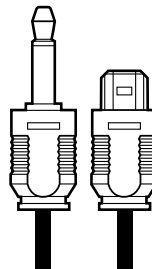

Digital Optical Cable

G



Turtle Beach Sticker



Table of Contents

About the STEALTH 500P	P5
Overview	P6
Parts and Controls	P7
Headset Charging	P8
PS4™ Setup	P9
PS3™ Setup	P12
Mobile Setup	P15
Pairing the Headset and Transmitter	P16
Adjusting sound (PS3/PS4)	P17
Specifications	P18
Troubleshooting tips	P19
Important safety information	P21

About the STEALTH 500P

The STEALTH 500P is an advanced gaming headset optimized for PS3™ and PS4™ consoles. It also unlocks the audio potential of music, movies and more. To get the most from your STEALTH 500P, please take a few moments to review this introduction.

Overview

The Ear Force® Stealth 500P is armed with completely wireless DTS Headphone:X 7.1 Channel Surround Sound and massive 50mm speakers for PS4 or PS3. Plus the comfortable, all-new headset design allows for quick access to vital audio customization and controls and its rechargeable battery delivers over 15 hours of gaming bliss per charge.



Crystal Clear Wireless

Intelligent channel-hopping for an interference-free wireless experience.



Never Miss a Text or Call

Hook up your mobile phone to hear text notifications or take calls while gaming.



Mobile Gaming Versatility

Connect the included Mobile Cable with In-line Mic for wired gaming on PS Vita™ or any mobile device.



Separate Volume Controls

Set your mix of Game and Chat volume levels right on the headset.

Overview



Comfortable & Quiet

Breathable, around-the-ear mesh cushions for hours of comfort and noise isolation.



Stop Shouting!

Mic Monitoring lets you hear your own voice in the headset to avoid shouting.



Awesome Turtle Beach Audio

Four EQ Presets and large 50 mm speakers combine to deliver butt-kicking audio.



Rechargeable Battery

Ditch the batteries with a built-in rechargeable battery that delivers up to 15 hours of wireless gaming.

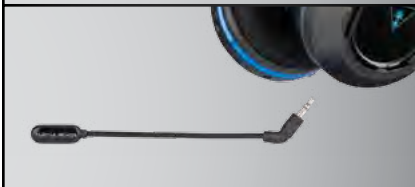

Removable Mic Boom

Be heard clearly through an adjustable high-sensitivity mic you can remove.



For All Your Audio Needs

Use the STEALTH 500P for movies and TV from Netflix™ and Hulu Plus™ or Blu-ray Disc. Crank up your tunes on music services like Pandora™ and then chat with friends or make mobile calls!



Step up to STEALTH

Ear Force® STEALTH headsets connect cutting edge wireless tech with advanced audio features so you win more, jump up the leaderboards and flat out hear your favorite games like never before.

Parts and Controls

Headset Controls: Right Earcup

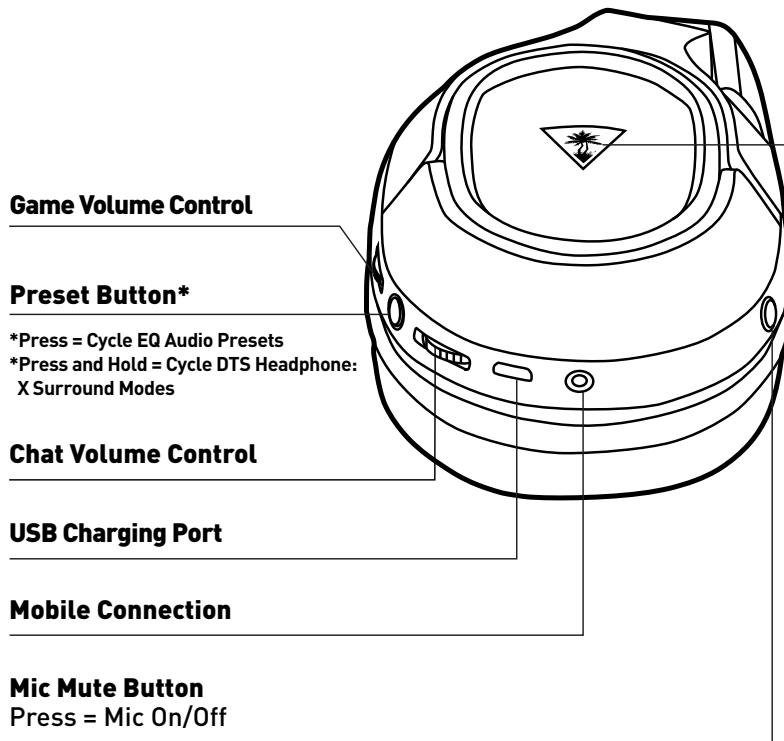

Game Volume Control

Preset Button*

*Press = Cycle EQ Audio Presets
*Press and Hold = Cycle DTS Headphone:
X Surround Modes

Chat Volume Control

USB Charging Port

Mobile Connection

Mic Mute Button

Press = Mic On/Off

Power Button

Hold (1s) = Power On / Power Off

Power LED

(Battery Status)

Red = Charging

Blue = Charged / In Use

(Pairing Status)

Single Blink = Transmitter Connected

Double Blink = Transmitter not Connected

Transmitter

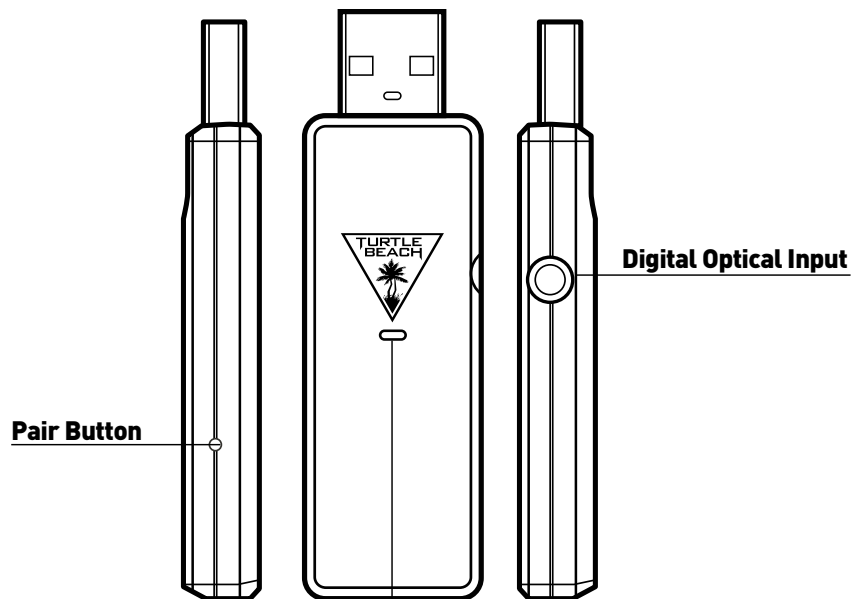

Pair Button

Digital Optical Input

*EQ Audio Presets and DTS Headphone:X Surround Modes are only available over the Wireless Game Audio Path.

(All Audio passed over the Digital Optical Audio Cable to the Stealth 500P Transmitter)

Connection Status LED

On (Continuously) = Headset Connected

Pulsing = Headset not connecting

Headset Charging

Even though the STEALTH 500P supports wired connection to mobile devices, it uses an internal amplifier and so requires power from its rechargeable battery.

NOTE: Make sure to charge your Headset regularly.

NOTE: Always charge your Headset before storing it for more than three months. Never store the headset in temperatures above 113°F/45°.

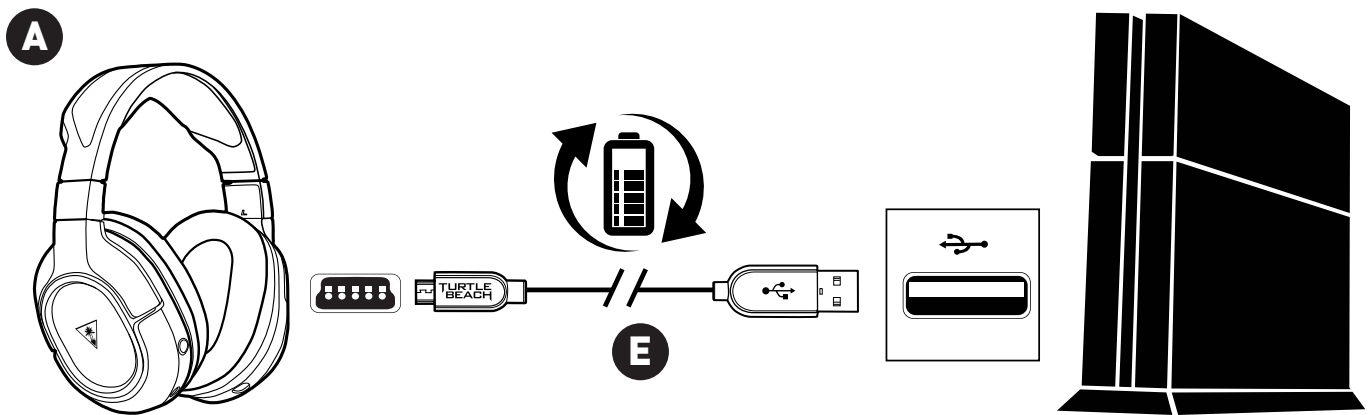

1. Connect the USB plug of the USB Charging Cable to a USB port.
2. Connect the micro USB plug of the USB Charging Cable to the USB Charging Port on the right earcup of the Headset.
3. Charging is complete when the Charge/Pairing Status LED on the Headset changes from Red to Blue.

PS4™ Setup

The Ear Force STEALTH 500P headset is designed for use with PS4™ consoles.

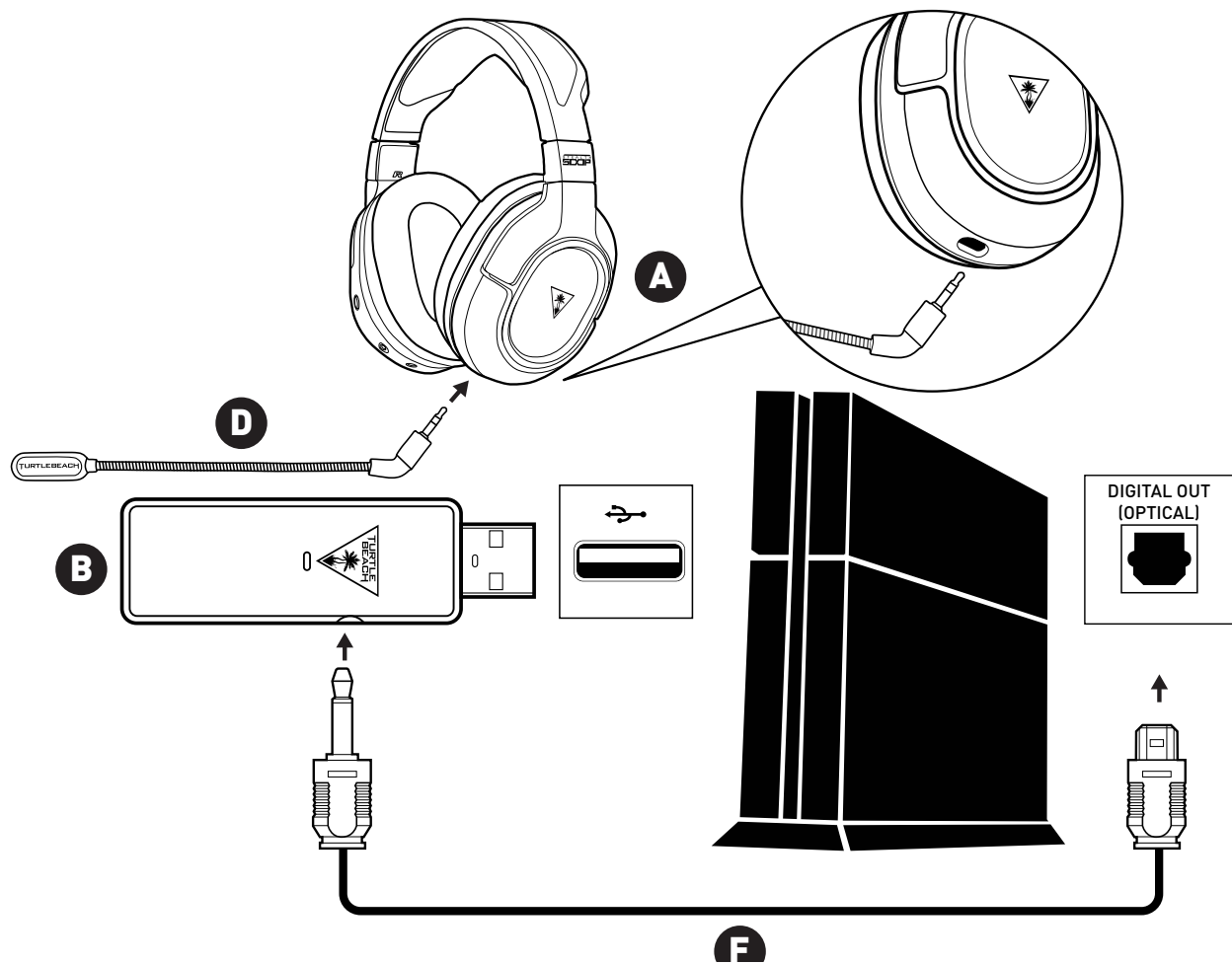

1. Plug the Removable Mic Boom into the jack on the left earcup of the Headset.
2. Connect the square optical plug of the Digital Optical Cable to the Digital Out (Optical) port of the PS4™ console.
3. Insert the small plug of the Digital Optical Cable into the Digital Optical Input on the side of the Wireless Transmitter.
4. Insert the Wireless Transmitter into a USB port on the PS4 console.

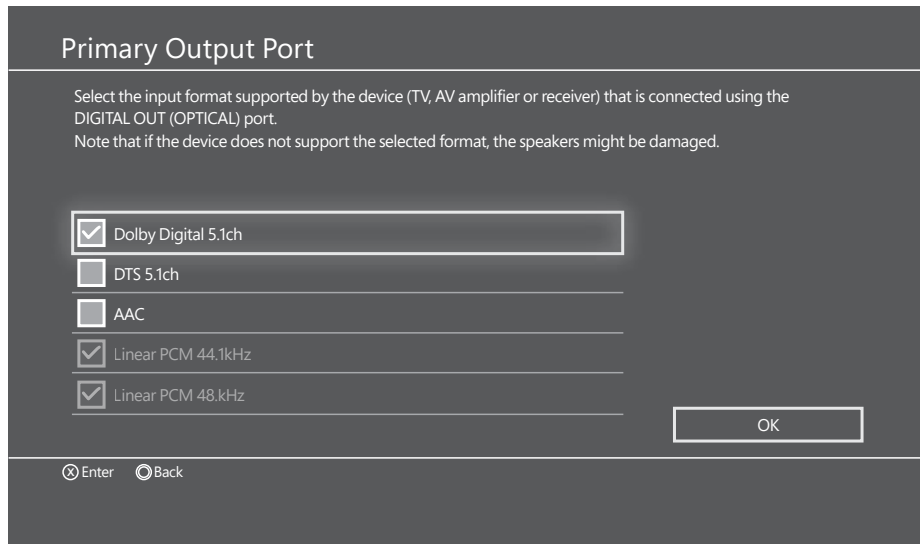

1. Go to Settings » Sound and Screen » Audio Output Settings » Primary Output Port » Digital Out” (OPTICAL).

2. Select Only Dolby Digital 5.1ch.

Note: Do NOT select DTS 5.1ch.

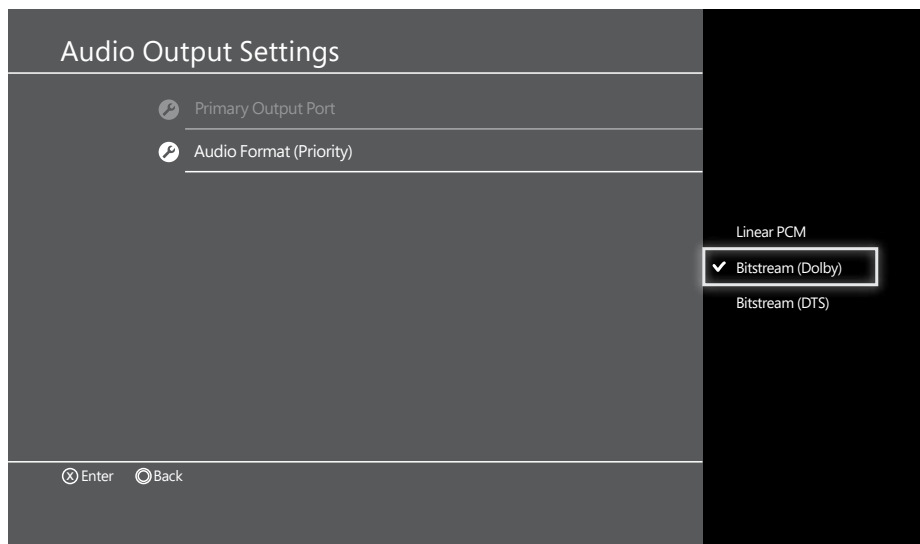

3. Go to Settings >> Sound and Screen >> Audio Output Settings >> Audio Format (Priority)

4. Select Bitstream (Dolby)

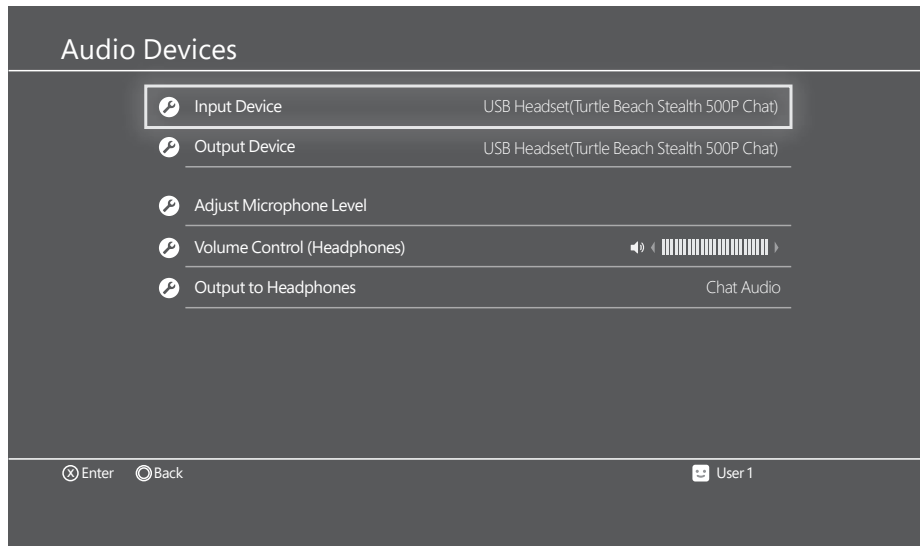

5. Go to Settings >> Devices >> Audio Devices

6. Select USB Headset(Turtle Beach Stealth 500P Chat) for Input & Output Device

7. Set Output to Headphones to **Chat Audio**

8. Set Volume Control (Headphones) level to maximum

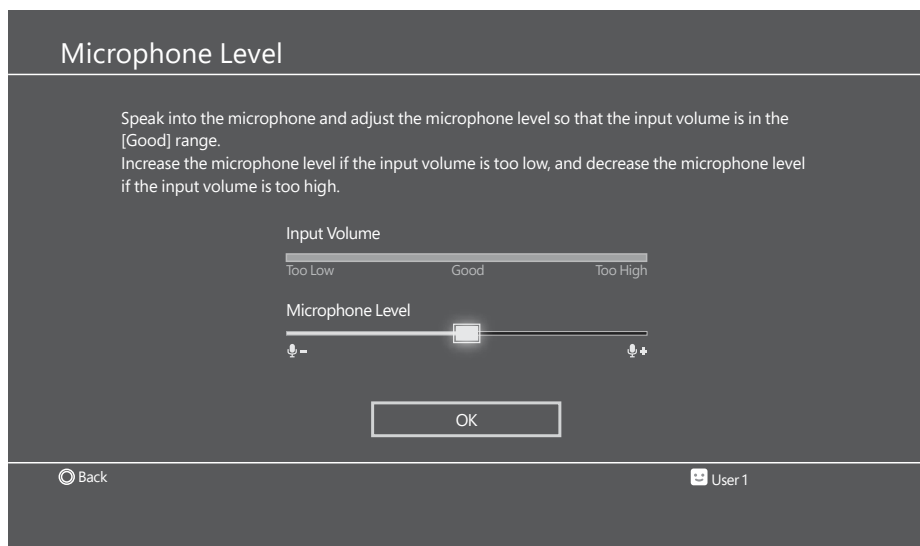

9. Select Adjust Microphone Level and follow the on-screen instructions to calibrate your microphone.

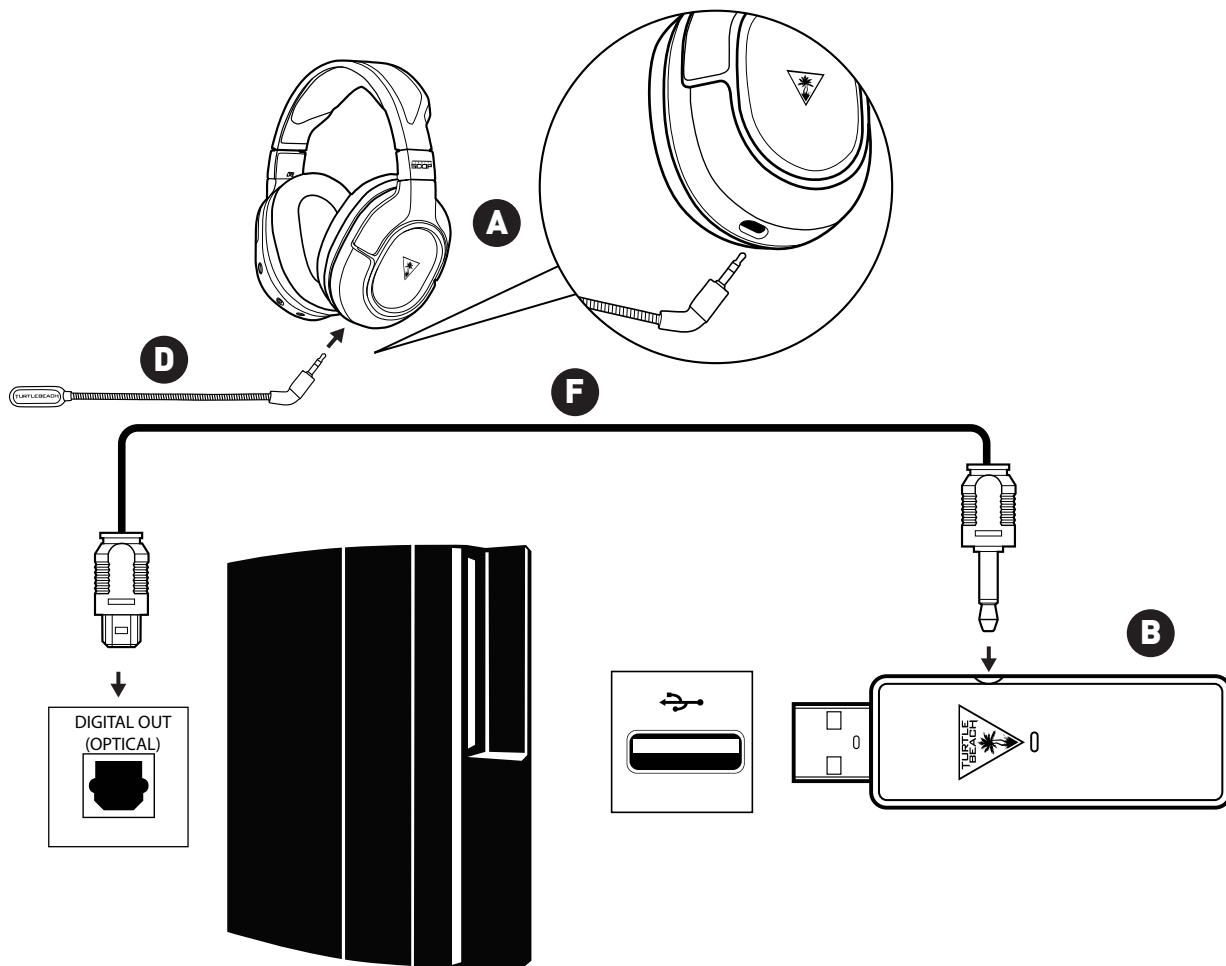

1. Plug the Removable Mic Boom into the jack on the left earcup of the Headset.
2. Connect the square optical connector of the Digital Optical Cable to the Digital Out (Optical) port of the PS3™ console.
3. Insert the small plug of the Digital Optical Cable into the Digital Optical Input on the side of the Wireless Transmitter.
4. Insert the Wireless Transmitter into a USB port on the PS3 console.

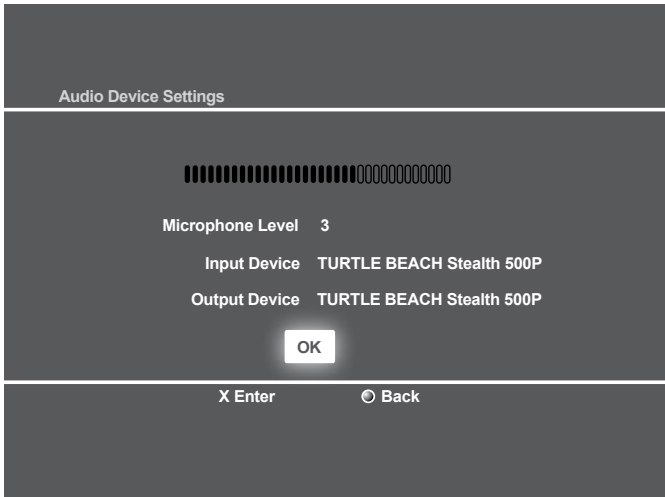

1. Go to Settings » Accessory Settings » Audio Device Settings

2. Set the Input Device and Output Device fields to Turtle Beach Stealth 500P.

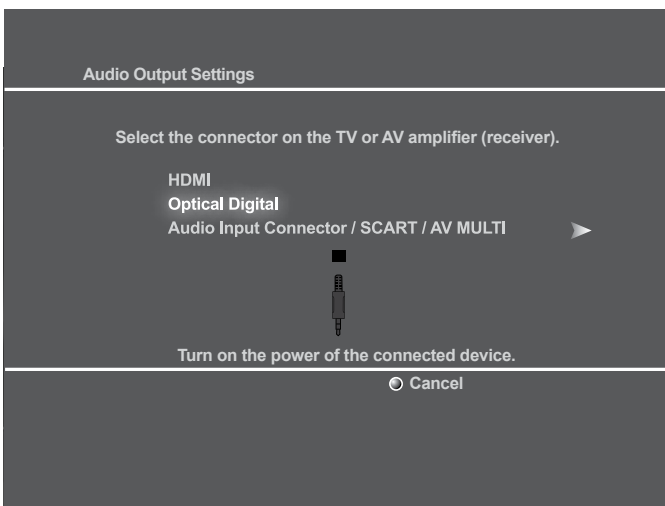

3. Go to Settings » Sound Settings » Audio Output Settings » Optical Digital

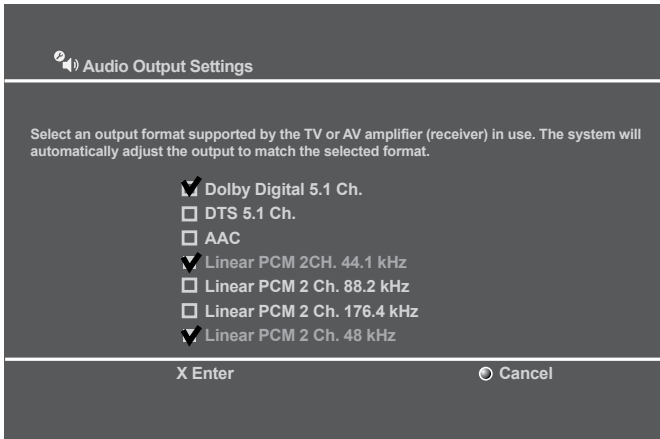

4. Check ONLY Dolby Digital 5.1 Ch.

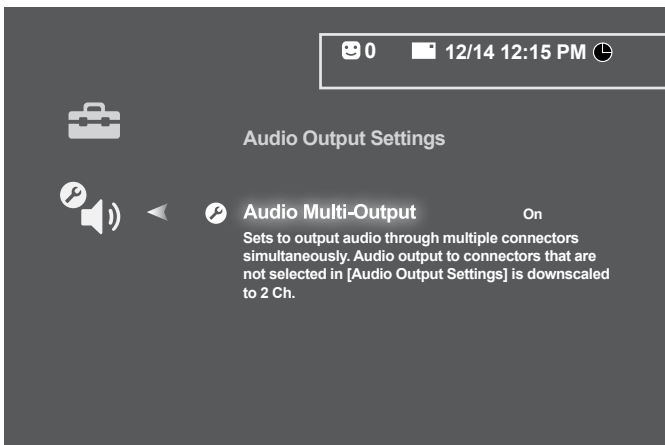

5. Go to Settings » Sound Settings » Audio Multi-Output

6. Set to On.

Mobile Setup

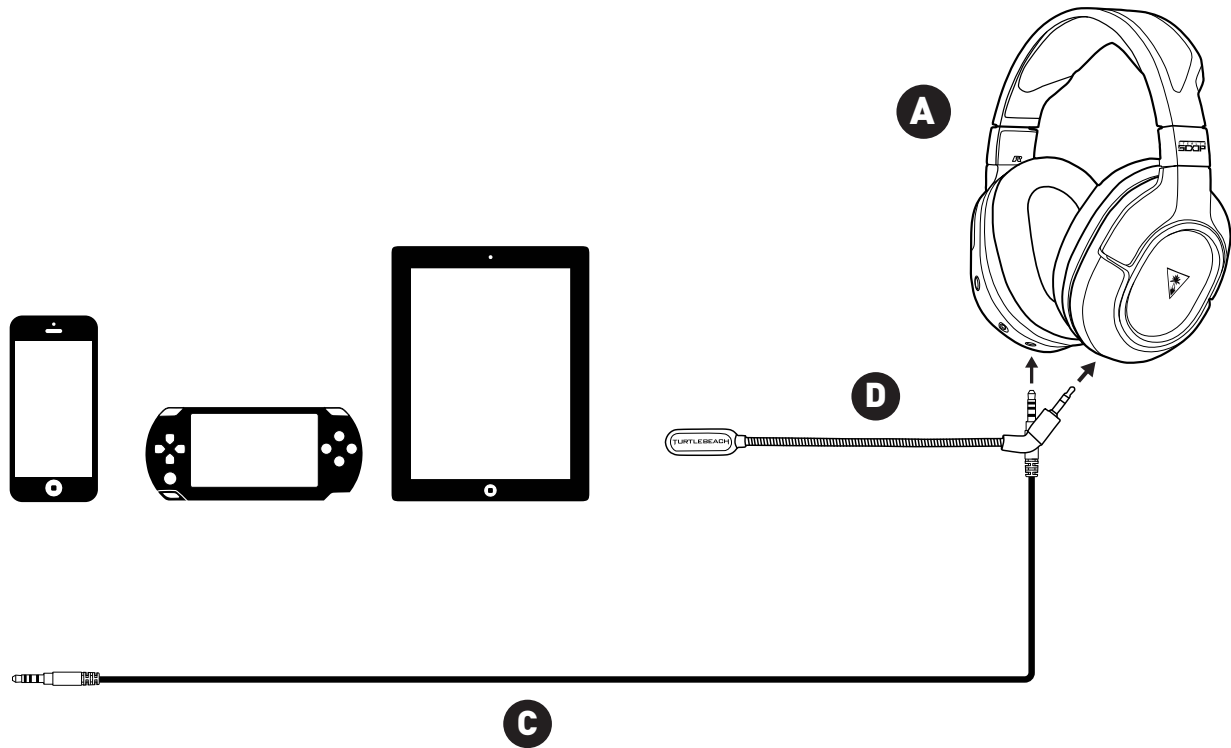

1. Insert one end of the Mobile Cable into the Mobile Connection on the right earcup of the Headset.
2. Insert the other end into the headset jack of your mobile phone, mobile game console, tablet or computer.

NOTE: The Volume controls on the headset do not affect your Mobile Audio. Make sure to control the audio level from your Mobile device. Mobile audio is not processed in DTS Headphone: X Surround Sound.

When using the Stealth 500P away from your console (Mobile Connection Only) after 15 minutes you may hear a prompt indicating that you must press the Power Button in order to continue use. This is built in for battery conservation, just press the power button to continue listening to music without interruption.

Pairing the Headset and Transmitter

NOTE: Your STEALTH 500P Headset ships from the factory already paired for communication with your Wireless Transmitter. In normal operation, it should not be necessary for you to pair the two again. You should only need to perform pairing yourself in the event that wireless communication fails. First check that the headset is powered on and is within range. If the Connection Status LED on the Wireless Transmitter is still pulsing, the Wireless Transmitter can't communicate with the Headset. Perform the following pairing procedure.

1. Start this process with the headset powered OFF. Press and hold the Pairing Button on the Transmitter until the Transmitter's Pairing LED flashes rapidly (5 seconds), then release. (Use a paper clip or something similar to press the Pinhole button)

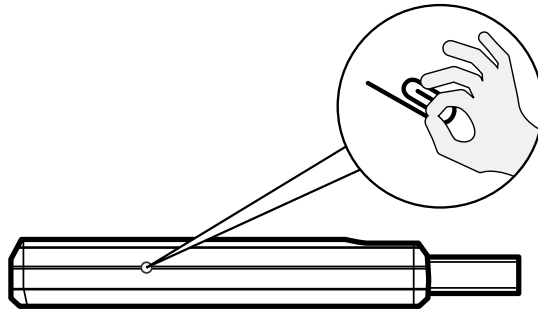

2. Press and hold the Power Button on the Headset until the Headset's Power LED flashes rapidly (5 seconds), then release.

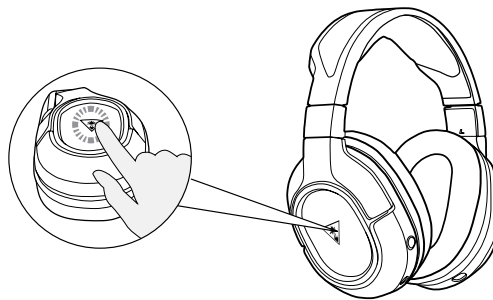

3. Within 10 seconds, the Transmitter's LED will remain on solid, and the Headset's Power LED will blink steadily once per second, indicating that pairing has been successful.

Adjusting sound (PS3/PS4)

NOTE: The following control functions are inactive when the Headset is connected to the Mobile Cable with In-Line Microphone.

If you want to...	Then...
Adjust game/media volume.	Use the Game Volume Control on the Headset.
Adjust chat volume.	Use the Chat Volume Control on the Headset.
Turn the microphone on or off.	Press the Mic Button on the Headset.
Adjust equalization (EQ)	<p>You can optimize the sound for your specific game or entertainment content. Press the Preset Button on the Headset to cycle through the following equalization preset modes:</p> <p>Natural Sound - Turtle Beach tuned Natural Sound, hear your media just as the creators intended.</p> <p>Bass Boost - Turn up the Bass, feel the deep sound effects in your games and the punch of bass heavy music tracks.</p> <p>Bass & Treble Boost - Turn everything up, increased lows and highs give you more of everything for a more powerful audio experience.</p> <p>Vocal Boost - Tune in to the vocals on music tracks and dialog in games and movies, makes your team-mates, characters and stories come alive as you've never heard before.</p>
<p>Adjust DTS Headphone: X 7.1 Surround Sound Mode</p> <p>Note: DTS Headphone:X Surround Modes are only available over the Wireless Game Audio Path.(All Audio passed over the Digital Optical Audio Cable to the Stealth 500P Transmitter)</p>	<p>The Stealth 500P takes advantage of DTS® Headphone:X Surround Sound, which uses sophisticated processing to create surround sound using just two speakers. The system reproduces the sonic characteristics of specific rooms, optimized for specific types of content. Hold down the Preset Button on the Headset to cycle through the Surround Modes.</p> <p>Surround 1 Game Mode Surround 2 Movie Mode Surround 3 Music Mode Surround 4 Surround Off</p>

Specifications

Headset

- **Speakers** 50mm with Neodymium Magnets
- **Frequency Response** 20Hz - 20kHz
- **Earpad Material** Perforated Leather (Black) with Foam Cushion
- **Earcup Design** Over-Ear (Closed)
- **Microphone Design** Removable Omni-Directional Microphone

Transmitter

- **Game Input** Digital Optical (Mini-Toslink)
- **Chat/Mic Input/Output** USB
- **Surround Sound Processing** DTS Headphone:X 7.1
- **Wireless Connection** RF with Intelligent Channel Hopping
- **Wireless Range** Up to 30ft
- **Power** USB



Troubleshooting Tips

No Sound

Possible cause	Solution
Power is off	Confirm that the Headset is on. The Charge/Pairing Status LED should be illuminated blue. NOTE: The Headset must be powered on for use, even when you're connected via the Mobile Cable.
Dead/low battery	Confirm that the Headset battery is charged.
Loose connection	<p>In game console use, confirm that Wireless Transmitter is properly seated in the USB port and that the Digital Optical Cable is firmly connected at both ends.</p> <p>In mobile use, confirm that the Mobile Cable plugs are firmly seated in the Headset and the mobile device.</p>
Lost pairing	Confirm that the Connection Status LED on the Wireless Transmitter stays on. If the LED is slowly pulsing on and off, it indicates that the Wireless Transmitter isn't communicating with the Headset. See Pairing the Headset and the Transmitter (page 16).

Audio Drops, Popping or Clicking Sounds

Possible cause	Solution
Poor Wi-Fi transmission	<p>For best performance, stand within 20 feet from the Wireless Transmitter.</p> <p>Confirm that there is no wall or other large object between the Headset and Wireless Transmitter.</p> <p>Confirm that the location of the Wireless Transmitter is clear of obstructions and isolated from Wi-Fi base stations or other potential sources of interference.</p>

Troubleshooting Tips

Voice Chat Drops

Most in-game voice chat drops are caused by network congestion or “lag.” They usually subside after a few moments so please be patient. In extreme cases, you may need to leave the game and return to reset the chat function.

If you use a wireless internet connection, low signal strength from your modem/router can make the voice chat malfunction. For best results, we recommend a wired connection from your modem/router to your game console.

Possible cause	Solution
Incorrect console setup	Confirm that the game console is properly configured for the STEALTH 500P. See PS4™ Setup (page 9) or PS3™ Setup (page 12).
Mic muted	Press the Mic Button on the Headset to toggle the microphone between on and off (muted).
Mic disconnected	Confirm that the Removable Mic Boom is firmly inserted into the Headset.

If your issue is not resolved by these steps, please visit turtlebeach.com/support

Important Safety Information

To avoid potential damage to the device, always disconnect all cables before transporting it.

WARNING: Permanent hearing damage can occur if a headset is used at high volumes for extended periods of time, so it is important to keep the volume at a safe level. Over time, your ears adapt to loud volume levels, so a level that may not cause initial discomfort can still damage your hearing. If you experience ringing in your ears after listening with the headset, it means the volume is set too loud. The louder the volume is set, the less time it takes to affect your hearing. So, please take care to listen at moderate levels.

- Before placing a headset on your ears, turn the volume down completely, then slowly increase it to a comfortable level.
- Turn down the volume if you can't hear people speaking near you.
- Avoid turning up the volume to block out noisy surroundings.

Regulatory Compliance Statements for the EAR FORCE Stealth 500P RX & TX Model

Federal Communications Commission (FCC) Compliance Notices

This section includes the following FCC statements for the EAR FORCE Stealth 500P RX & TX Models:

- FCC ID: XGB-TB3270(Headset)
- FCC ID: XGB-TB3271(Transmitter)
- Class B Interference Statement
- RF Radiation Exposure & Hazard Warning
- Non-Modification Statement
- Deployment Statement

Class B Interference Statement

This equipment has been tested and found to comply with the limits for a Class B digital device, pursuant to Part 15 of the FCC Rules. These limits are designed to provide reasonable protection against harmful interference in a residential installation. This equipment generates, uses, and can radiate radio frequency energy and, if not installed and used in accordance with the instructions, may cause harmful interference to radio communications. However, there is no guarantee that interference will not occur in a particular installation. If this equipment does cause harmful interference to radio or television reception, which can be determined by turning the equipment off and on, the user is encouraged to try to correct the interference by one or more of the following measures:

- Reorient or relocate the receiving antenna.
- Increase the separation between the equipment and receiver.
- Connect the equipment into an outlet on a circuit different from that to which the receiver is connected.
- Consult the dealer or an experienced radio/TV technician for help.

FCC Caution:

This device complies with Part 15 of the FCC Rules. Operation is subject to the following two conditions: (1) This device may not cause harmful interference, and (2) this device must accept any interference received, including interference that may cause undesired operation.

RF Radiation Exposure & Hazard Statement

To ensure compliance with FCC RF exposure requirements, this device must be installed in a location such that the antenna of the device will be greater than 2 cm (0.8 in.) from all persons. Using higher gain antennas and types of antennas not covered under the FCC certification of this product is not allowed. Installers of the radio and end users of the product must adhere to the installation instructions provided in this manual. This transmitter must not be co-located or operated in conjunction with any other antenna or transmitter.

Non-Modification Statement

Use only the supplied internal antenna. Unauthorized antennas, modifications, or attachments could damage the EAR FORCE Stealth 500P RX & TX Models and violate FCC regulations. Any changes or modifications not expressly approved by the party responsible for compliance could void the user's authority to operate this equipment. Please contact Turtle Beach for a list of approved 2.4 GHz antennas.

European Union and European Fair Trade Association (EFTA) Regulatory Compliance

This equipment may be operated in the countries that comprise the member countries of the European Union and the European Fair Trade Association. These countries, listed below, are referred to as The European Community throughout this document:

AUSTRIA, BELGIUM, BULGARIA, CYPRUS, CZECH REPUBLIC, DENMARK, ESTONIA, FINLAND, FRANCE, GERMANY, GREECE, HUNGARY, IRELAND, ITALY, LATVIA, LITHUANIA, LUXEMBOURG, MALTA, NETHERLANDS, POLAND, PORTUGAL, ROMANIA, SLOVAKIA, SLOVENIA, SPAIN, SWEDEN, UNITED KINGDOM, ICELAND, LICHTENSTEIN, NORWAY, SWITZERLAND

Declaration of Conformity

Marking by this symbol: 

indicates compliance with the Essential Requirements of the R&TTE Directive of the European Union (1999/5/EC). This equipment meets the following conformance standards:

Safety: EN 60950-1: 2006 + A11: 2009 + A1: 2010 + A12: 2011 (T-Mark License).
IEC 60950-1: 2005 (2nd Edition) + Am 1: 2009 (CB Scheme Report/Certificate),
EN 50332-1: 2000, EN50332-2: 2003

EMC: EN 55022: 2010, EN 301 489-1 v1.9.2 (2011-09), EN 301 489-17 v2.2.1 (2012-09),
EN 61000-4-2: 2008-05, EN 61000-4-3: 2010-04, EN 61000-4-8 (2008-10)

Radio: EN 300 328 v.1.7.1 (2006-10)

SAR: EN 62311: 2008

Environmental : Low Voltage Directive 2006/95/EC, RoHS 2011/65/EU,
WEEE 2002/96/EC, REACH 2006/1907/EC, Packaging 94/62/EC,
Battery 2006/66/EC

Warning!

This is a Class B product. In a domestic environment, this product may cause radio interference, in which case, the user may be required to take appropriate measures.

Achtung!

Dieses ist ein Gerät der Funkstörgrenzwertklasse B. In Wohnbereichen können bei Betrieb dieses Gerätes Rundfunkstörungen auftreten, in welchen Fällen der Benutzer für entsprechende Gegenmaßnahmen verantwortlich ist.

Attention!

Ceci est un produit de Classe B. Dans un environnement domestique, ce produit risque de créer des interférences radioélectriques, il appartiendra alors à l'utilisateur de prendre les mesures spécifiques appropriées.



This symbol on the product or its packaging indicates that this product must not be disposed of with your other household waste. Instead, it is your responsibility to dispose of your waste equipment by handing it over to a designated collection point for the recycling of waste electrical and electronic equipment. The separate collection and recycling of your waste equipment at the time of disposal will help conserve natural resources and ensure that it is recycled in a manner that protects human health and the environment. For more information about where you can drop off your waste for recycling, please contact your local authority, or where you purchased your product.

LIMITED ONE YEAR WARRANTY FOR TURTLE BEACH PRODUCTS:

Voyetra Turtle Beach, Inc. ("VTB") warrants to the original end-user purchaser ("Purchaser") that the retail Turtle Beach hardware product herein ("Product") will be free of defects in materials and workmanship for a period of one year from the date of purchase by the Purchaser ("Warranty Period"). Any Extended Warranty or Service Plans purchased through a Retail store are not honored by VTB. The Warranty refers to the repair/replacement of a defective product during this period and not a refund.

This limited warranty is extended only to the original Purchaser of a new product, which was not sold "AS IS". It is not transferable or assignable to any subsequent purchaser. This limited warranty is applicable only in the country or territory where the Product was purchased from an authorized VTB retailer and does not apply to a Product that has been purchased as used or refurbished or was included as part of a non-VTB product.

WARRANTY SERVICE:

In the USA and CANADA Warranty Service is provided by our Turtle Beach USA offices and in all other Countries it is provided by our local International Distributors when available. Refurbished/Recertified products are sold on an AS IS basis with a 90-day Warranty or less in accordance with each vendor's policy.

VTB does not warrant uninterrupted or error-free operation of the Product and is under no obligation to support the Product for all computer operating systems or future versions of such operating systems.

If a defect should occur during the Warranty Period, Purchaser must contact VTB to obtain a Return Merchandise Authorization ("RMA") number on the basis of the dated purchase receipt. Purchaser will be responsible for shipping costs incurred in returning the defective Product to an authorized VTB service center, or to the repair facility located at VTB's corporate headquarters. VTB will not be responsible for other products or accessories included with the defective Product sent to VTB. The RMA number must be clearly indicated on the outside of the package. Packages without an RMA number will be refused by VTB or its representatives and returned to sender at the sender's expense.

In the event of a defect, Purchaser's sole and exclusive remedy, and VTB's sole liability, is expressly limited to the correction of the defect by adjustment, repair, or replacement of the Product at VTB's sole option and expense. VTB owns all Products it has replaced and all parts removed from repaired Products. VTB uses new and reconditioned parts made by various manufacturers in performing warranty repairs and building replacement products. If VTB repairs or replaces a product, the original Warranty Period is not extended, however, VTB warrants that repaired or replacement parts will be free from defects in material and workmanship for a period of thirty (30) days from the date of repair or replacement, or for the remainder of the Warranty Period, whichever is greater.

This warranty does not apply to any Product that has had its serial number altered, removed or defaced, or any Product damage caused by shipping, improper storage, accident, problems with electrical power, abuse, misuse, neglect, ordinary wear, acts of God (e.g. flood), failure to follow directions, improper maintenance, use not in accordance with product instructions, unauthorized modification or service of the Product or damage resulting from the use of the Product with hardware, software or other products not provided by or specifically recommended by VTB.

NOTES:

- Replacement Parts and accessories that are subject to "wear and tear" such as earpads, mic foam covers, talkback cables, etc. have a three (3) month Warranty.
- Replacement Parts for Discontinued Products are sold on an AS IS basis, they are not supported and come with a 30 day Warranty.

THIS LIMITED WARRANTY IS PURCHASER'S SOLE AND EXCLUSIVE REMEDY AND IS IN LIEU OF ALL OTHER WARRANTIES, EXPRESS OR IMPLIED. TO THE EXTENT PERMITTED BY APPLICABLE LAW, VTB HEREBY DISCLAIMS THE APPLICABILITY OF ANY IMPLIED WARRANTY OF MERCHANTABILITY, FITNESS FOR A PARTICULAR PURPOSE OR USE FOR THE PRODUCT. IF SUCH A DISCLAIMER IS PROHIBITED BY APPLICABLE LAW, THE IMPLIED WARRANTY IS LIMITED TO THE DURATION OF THE FOREGOING LIMITED WRITTEN WARRANTY.

IN NO EVENT SHALL VTB BE LIABLE FOR ANY INDIRECT, INCIDENTAL, SPECIAL, PUNITIVE OR CONSEQUENTIAL DAMAGES, OR DAMAGES, INCLUDING BUT NOT LIMITED TO ANY LOST PROFITS, DATA, OR LOSS OF USE, ANY THIRD PARTY CLAIMS, AND ANY INJURY TO PROPERTY OR BODILY INJURY (INCLUDING DEATH) TO ANY PERSON, ARISING FROM OR RELATING TO THE USE OF THIS PRODUCT OR ARISING FROM BREACH OF THE WARRANTY, BREACH OF CONTRACT, NEGLIGENCE, TORT, OR STRICT LIABILITY, EVEN IF VTB HAS BEEN ADVISED OF THE POSSIBILITY OF SUCH DAMAGES.

This warranty supersedes all prior agreements or understandings, oral or written, relating to the Product, and no representation, promise or condition not contained herein will modify these terms. Some states do not allow the exclusion or limitation of incidental or consequential damages, so the above exclusion or limitation may not apply to you. This warranty gives you specific legal rights. You may also have other rights, which vary from state to state. Any action or lawsuit for breach of warranty must be commenced within eighteen (18) months following the purchase of the Product.

EXCLUSIONS FROM LIMITED WARRANTY:

This Limited Warranty shall not apply and VTB has no liability under this Limited Warranty if the Turtle Beach Product:

- is used for commercial purposes such as "LAN, Call Centers" (including rental or lease);
- is modified or tampered with;
- is damaged by Acts of God, power surge, misuse, abuse, negligence, accident, wear and tear, mishandling, misapplication, or other causes unrelated to defective materials or workmanship;
- serial number is defaced, altered or removed;
- is not used in accordance with the documentation and use instructions; or
- is repaired, modified or altered by other than authorized repair centers.
- is no longer available because it was discarded.

For
PS4™ | PS3™ | Mobile Gaming



Watch Turtle Beach product training videos at:
youtube.com/TurtleBeachVideos



Product support and warranty information:
TurtleBeach.com/support

© 2014 Voyetra Turtle Beach, Inc. Turtle Beach, the Palm Tree Logo, Voyetra, Ear Force, and Audio Advantage are trademarks of Voyetra Turtle Beach, Inc. For DTS patents, see <http://patents.dts.com>. Manufactured under license from DTS Licensing Limited. DTS, the Symbol, & DTS and the Symbol together are registered trademarks, and DTS Headphone:X is a trademark of DTS, Inc. © DTS, Inc. All Rights Reserved. PlayStation, PS4, PS3 and PS Vita are trademarks of Sony Computer Entertainment, Inc. Actual product appearance may differ from package imagery.

This product is compliant with the Consumer Product Safety Improvement Act of 2008, Public Law 110-314 (CPSIA)