



CARPET WASHER

Model #'s DDW02-E01
DDW02-R01



1·2·3...

USER GUIDE



LET'S GO.™

WARNING

BASIC SAFETY PRECAUTIONS

- This carpet washer is intended for household use only and NOT for commercial or industrial use.
- Only use the carpet washer indoors and keep the area you're cleaning well lit.
- Keep fingers, hair and loose clothing from moving parts and openings whilst using the carpet washer.
- This carpet washer is NOT to be used by children under eight years or persons with reduced physical, sensory or mental capabilities, unless they have been given instructions on how to use the machine or are supervised during use.
- Any cleaning or maintenance of your carpet washer should not be made by children without supervision and ensure they don't play with the carpet washer.
- Before using your carpet washer test your carpets/rugs/upholstery for colourfastness and pile distortion.
- Only Dirt Devil recommended tools and solutions should be used with this carpet washer. Using other solutions may invalidate the guarantee.

DON'TS

- Don't leave the carpet washer plugged in when unattended.
- Don't use this carpet washer if it has been dropped, damaged or left outdoors.
- Don't run over the power cord or use carpet washer if the power cord or plug is damaged. Please contact our Customer Care Line on: 0330 026 2626 (Mon-Fri 09:00-5:00).
- Don't use your carpet washer to pick up any flammable or combustible materials (lighter fluid, petrol, kerosene etc.) or use the carpet washer in an area with explosive vapours or liquid.
- Don't handle the plug or use the carpet washer with wet hands.
- Don't carry the carpet washer while it's switched on.
- Don't pull or carry this carpet washer by the power cord.
- Don't use the power cord as a handle, pull the power cord around corners, sharp edges or close a door over the power cord.
- Don't unplug carpet washer by pulling on the power cord.
- Don't attempt to remove blockages with sharp objects as this may cause damage to your carpet washer.





WARNING



DON'TS CONTINUED...

- Don't use your carpet washer to pick up hot coals, cigarette butts, matches or smoking hot burning items or use in an area where there may be harmful fluids (chlorine, bleach, and ammonia drain cleaner).
- Don't over saturate your carpet.
- Don't use the carpet washer with incorrect voltage as this may result in damage or injury to the user. The correct voltage is listed on the ratings label.

DO'S

- Check with the manufacturer of your flooring prior to using the carpet washer.
- The clean water tank should only be filled with warm water (max 40°C). Filling the clean water tank with hot or boiling water may damage your machine and invalidate your guarantee.
- Store your carpet washer in a cool, dry area. Before storing your carpet washer please ensure all water solutions tanks and filters are thoroughly clean and dry.
- Always vacuum your carpets thoroughly before using your carpet washer.
- Always unplug the carpet washer before carrying out any maintenance and before connecting or disconnecting the hose/accessories.
- Turn off all controls on the carpet washer before disconnecting or connecting the power cord, after use always wrap the power cord around the cord clips provided.
- Always replace the fuse in the plug with a British 13amp fuse.
- Always protect the power cable from heated surfaces or open flames.
- Always keep the power cord away from the brushes whilst using your carpet washer.
- Use only CE approved 13amp extension cords, non-approved extension cords may overheat. Care should be taken to arrange the extension cord as it can be a trip hazard.
- Take extra care when cleaning on the stairs.
- Always use the carpet washer with all water/solution tanks and filters in place.
- Keep all openings clear and free from debris as this may affect the airflow/suction.
- Always use the carpet washer in an upright position. To prevent motor damage from dirty water, never hold the carpet washer upside down or lay on its side.

PLEASE KEEP INSTRUCTIONS FOR FURTHER USE AND USE ONLY AS INSTRUCTED IN THIS GUIDE



HI. WELCOME.

Congrats on purchasing your new Dirt Devil® Carpet Washer. Inside, you'll find everything you want to know from the quick start guide to how to.

So what are you waiting for? LET'S GO.™



PRODUCT REGISTRATION

Warranty Registration

Be sure to register your product online at www.dirtdevil.co.uk.

Hint: Attach your sales receipt to this User Guide. Verification of date of purchase may be required for warranty service of your Dirt Devil® product.

For quick reference, please record your product information below.

Model #: _____

Serial number: _____

(Serial number located on the machine's rating label on back or bottom of product)

TABLE OF CONTENTS



Preparing the Carpet



1·2·3...

Quick Start Assembly

How to

Fill the Clean Water Tank

Operate the Carpet Washer

Use the Hose Attachment

Use the Wash Tool

Empty the Dirty Water Tank

Clean the Dirty Water Tank

Replace the Dirty Water Tank

Remove and Replace Belt or Brushbar

Clean the Filter



Trouble Shooting



Limited Guarantee

PREPARING THE CARPET

CAUTION

To reduce the risk of fire, electric shock due to internal component damage, use only Dirt Devil brand cleaning solution intended for use with this appliance.

1. Vacuum carpet thoroughly with a Dirt Devil® cleaner.
 2. Place plastic or foil under and around the legs of furniture before using the carpet washer and leave until the carpet has completely dried.
-

HELPFUL HINTS FOR CLEANING CARPET

- Plan your route so you don't walk over previously cleaned areas.
- Additional applications may be needed for heavily soiled areas.
- Do not oversaturate your carpet with cleaning solution.
- Be sure to rinse carpet thoroughly with water.
- Wipe cleaning solution from wood to prevent damage.



CAUTION

Do not use the carpet cleaner as a dry vacuum.



CAUTION

Do not store the carpet cleaner in garage or area where unit could freeze.

AFTER CLEANING

- Allow carpet to dry completely. Try not to walk on the carpet until it is dry.
- If you need to walk on the carpet, place white towels on the areas you want to walk.
- If the carpet is not dry and the furniture must be placed back in the room, use plastic or foil under the furniture to prevent staining the carpet.
- Thoroughly clean the dirty water tank with warm water (max 40°C).



NOTE: Do not transport the carpet cleaner with either the Clean Water Solution Tank or Dirty Water Tank full.

QUICK START

CAUTION

To reduce the risk of fire, electric shock, or injury: ensure the power cord is out of the way before attaching the upper handle.

CHECK FOR COLOUR FASTNESS

Before cleaning carpet/upholstery, test for colour fastness. Dampen a white cloth with solution. Test in an inconspicuous area. Gently rub the cloth over the area. Check each colour for colour bleeding. If the cloth remains clean, it should be safe to clean the carpet/upholstery.

ASSEMBLY

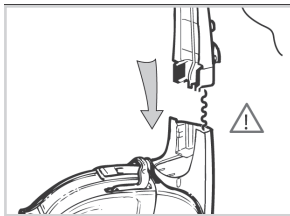

1

ATTACH UPPER HANDLE
To attach the upper handle stand the base in the upright position. Assemble the mid section onto the base, taking care not to trap internal mains wire.

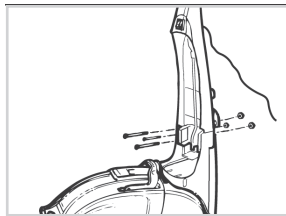

2

Insert the two nuts into the recesses located on the left and right sides of the base. While holding the nuts in place, insert the two medium length screws through the front of the mid section and tighten.

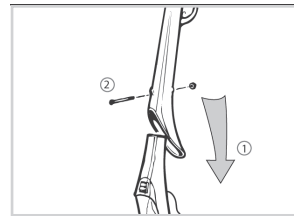

3

Fit the handle into the main body of the unit. Hold the nut in place, insert the long screw through the front of the upper handle and tighten.

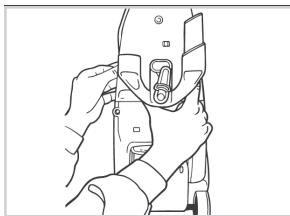

4

To assemble the hose/tool caddy (some models only) align the tabs on the hose/tool caddy with slots on the mid section and snap into place.

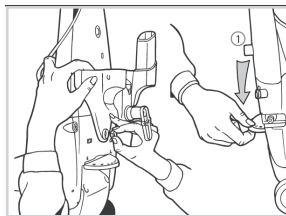

5

Place nut into recess on hose/tool caddy and hold into place. Press handle release with your other hand to tilt the midsection backwards.

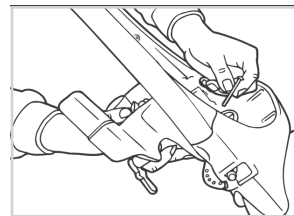

6

Place screw through centre of lower midsection and tighten.

⚠ CAUTION

To reduce the risk of damage: Do not use this extractor on hard floors. Using this machine on hard floors may scratch or damage your floors.

⚠ CAUTION

To avoid damage to your flooring switch the brush bar off whilst in a stationary position or when using the hose and accessories.

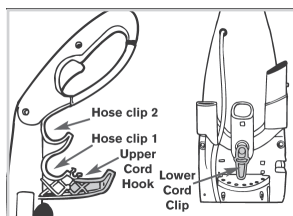

7

Wrap the cord around the hook and cord release clips.

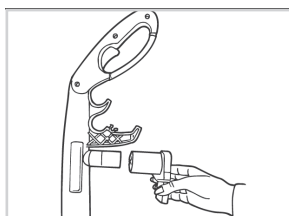

8

Detach the hose adaptor from the end of the hose and slide it onto the adaptor post.

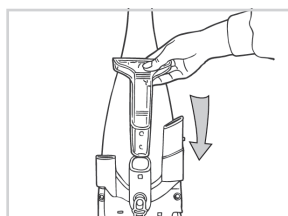

9

Fit the wash tool into the middle slot of the hose/tool caddy.

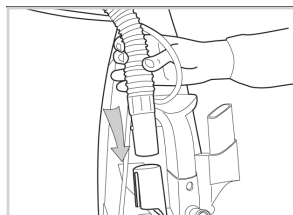

10

Clip the adaptor end of the hose into the left slot on the hose/tool caddy. Be sure to line the push-pin with the slot and slide down until secured.

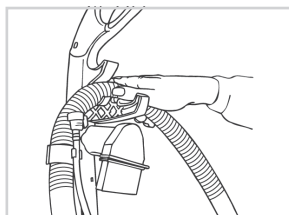

11

Wrap hose round the upper hose wrap, anti-clockwise, twice, ensuring the hose is secured in the hose clips.

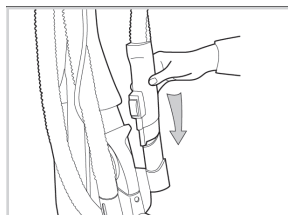

12

Lock the attachment end of the hose into place by clipping into the right slot on the lower tool caddy.

LET'S GO.™

HOW TO

FILL THE CLEAN WATER TANK

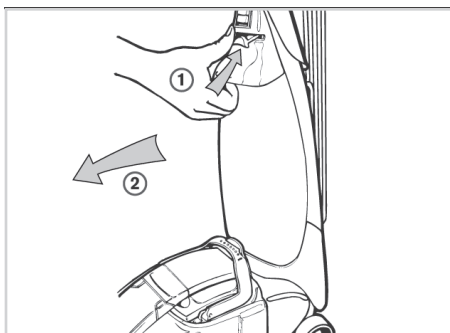

1. Remove clean water tank from the carpet washer

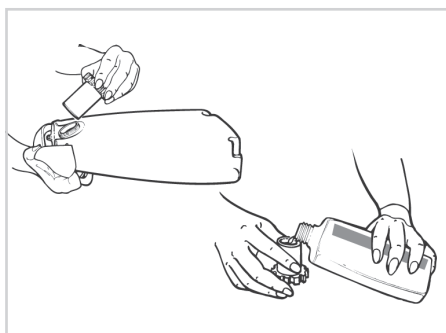

2. Unscrew the filler/measure cap from the rear of the clean water tank. Fill the bottle cap or measure cap 3 times with Dirt Devil carpet cleaning solution and pour into the tank.

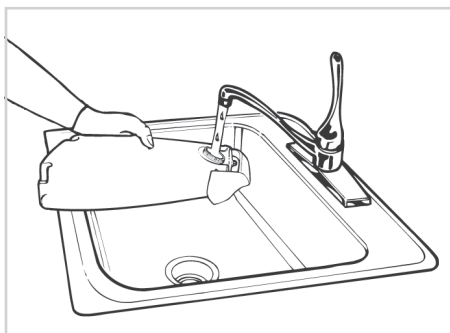

3. Fill the remainder of the clean water tank with warm (max 40°C) tap water. Replace the cap.

⚠ CAUTION

Don't over saturate your carpet.

⚠ CAUTION

To reduce the risk of fire and electric shock due to internal component damage, use only Dirt Devil brand cleaning solution intended for use with this appliance.

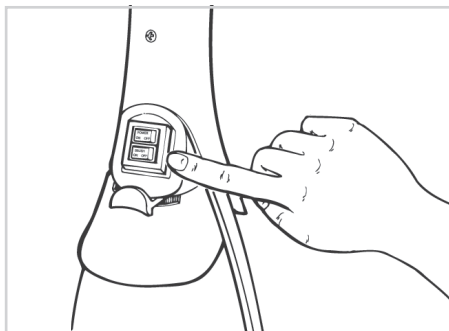
OPERATE THE CARPET WASHER

1. Plug into a mains. Turn the power and brushbar switches on. The switches are located on the front of the carpet washer, above the clean water tank. The power switch controls the motor and pump, the brush switch only turns the rotating brushbar on and off when the power switch is on.

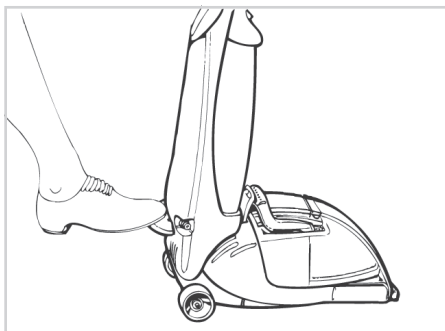

2. Press on the handle release pedal and pull the cleaner back into a reclined position.



3. While pressing the solution release trigger, push the cleaner in a forward motion. Release the trigger and pull the cleaner backwards over the same path to remove the dirty water and solution from the carpet. Repeat if necessary.

HOW TO

USE THE HOSE ATTACHMENTS (SOME MODELS ONLY)

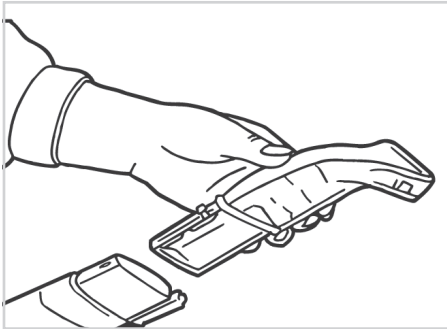

1. Stand carpet washer in the upright position. Remove tools from storage caddy. Connect the upholstery attachment to the trigger adapter.

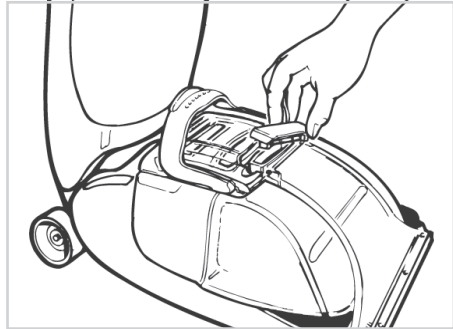

2. Remove the tank door from the top of the dirty water tank.



3. Insert the hose adapter into the top of the dirty water tank.

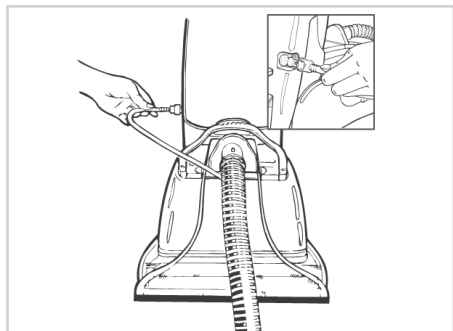

4. Connect the hose water supply plug into the socket on the lower left side of the cleaner.

! IMPORTANT

If you hear a noticeable change in the pitch of the cleaner. This indicates a need to empty the dirty water tank.

! CAUTION

Don't over saturate your upholstery.

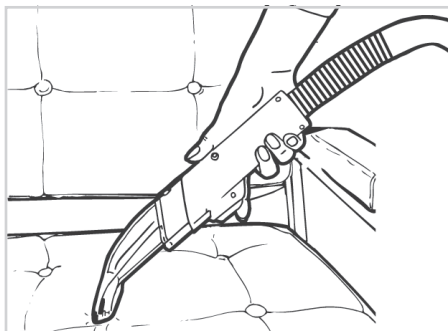
USE THE WASH TOOL (SOME MODELS ONLY)

1. Turn power switch on and brush switch off. While depressing the solution spray trigger, push attachment in forward motion. Release trigger and pull attachment backwards over the same path to remove dirty water and solution from upholstery. (For heavily soiled areas, repeat if necessary).

EMPTY THE DIRTY WATER TANK

1. Grasp the top of the dirty water tank handle and press the release latch.

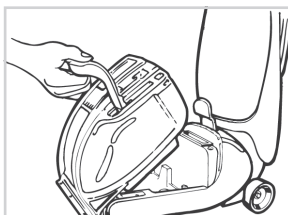

2. Pull the dirty water tank up out of the base, taking care to ensure that no dirty water leaks from the front.

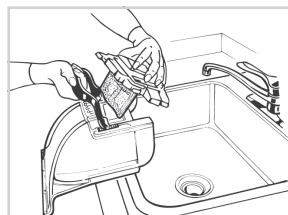

3. Remove dirty water tank lid.



4. To empty the water tank grasp the handle with one hand and the nozzle with the other and empty into the sink.

! IMPORTANT: Empty and rinse out clean and dirty water tank and leave to air dry before replacing. Do not leave solution stored in tank between uses.

! IMPORTANT: The float in your carpet washer will shut off suction when the dirty tank is full. For best results, use a smooth steady motion, keeping the nozzle flat against the carpet. Once the float is activated, empty the dirty water tank. If the tank does not appear full, turn off the power switch and wait for the float to settle.

HOW TO

CLEAN THE DIRTY WATER TANK



1. Rinse the dirty water tank and filter thoroughly with warm water. You should allow them to dry fully before replacing them on your cleaner to prevent mildew.

REPLACE THE DIRTY WATER TANK

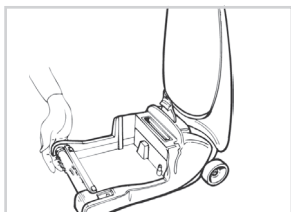

1. Tilt the front of the carpet cleaner base off the carpet with one hand.

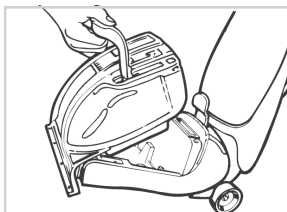

2. Grasp the handle and hook the front of the dirty water tank into the base, making sure that the front of the dirty water tank is resting on the base. The dirty water tank has three tabs on the underside which **MUST** latch on to the underside of the base of the cleaner. The base must be lifted so that the nozzle is flush with the base of the cleaner.



3. While making sure the dirty water tank is resting on the base, place the rear of the tank into the base of the cleaner, push down on the handle until it clicks into place. Empty and rinse clean the water tank after use.

NOTE: Failure to install the dirty water tank correctly will result in poor dirty water pick up.

HOW TO

! **CAUTION**
Don't over saturate your upholstery.

REMOVE AND REPLACE THE BELT OR BRUSHBAR

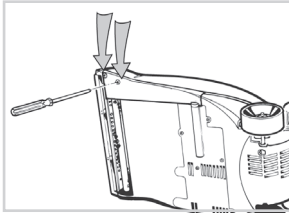

1. Remove the dirty water and clean water tank. Switch off and unplug the carpet washer. Flip the cleaner on it's side to expose the nozzle base. To remove the belt cover, use a phillips screwdriver to remove the two screws.

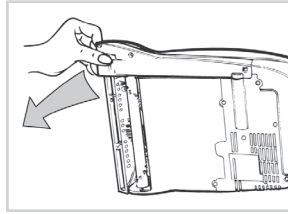

2. Hold the belt cover near the belt roll and lift out.

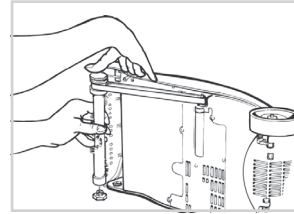

3. Grasp the brushbar with one hand, using the other hand to keep tension on the the belt while removing.

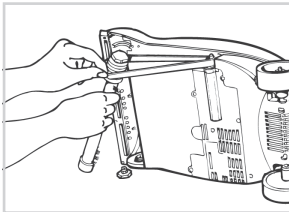

4. Lift brushbar while pulling it out.

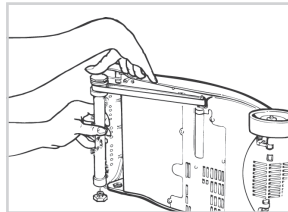

5. Slide the belt off the the motor shaft and dispose. When replacing the belt, first slide it onto the motor shaft. Then slip the brushbar through the belt. Place the belt in the area of the brush without bristles.

Slide the brushbar into the nozzle, ensuring that the brushbar end caps line up correctly.

Manually turn the brushbar to check that it is fitted properly.

Replace the belt cover by inserting the end furthest from the brush first. Then replace the front of the belt cover before securing in place with the two screws.

CLEAN THE FILTER

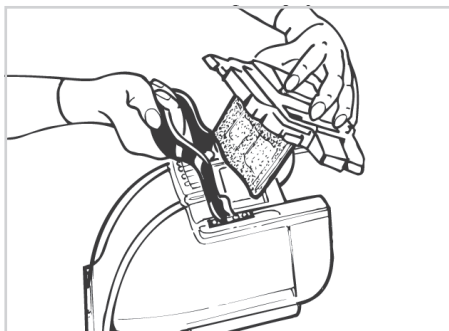

1. Remove dirty water tank lid.

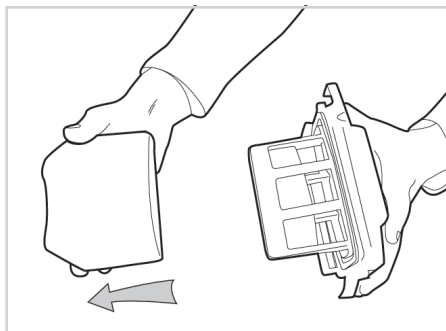

2. Separate the foam filter from the float.



3. Rinse the filter in water (40°C max).

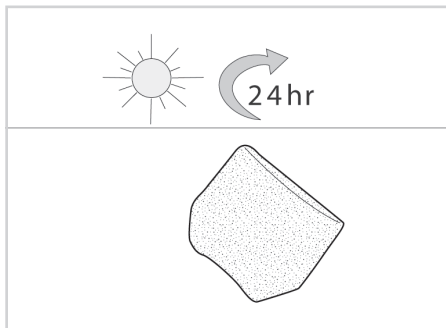

4. Allow the filter to air dry completely before storing your machine.

TROUBLESHOOTING

If a minor problem occurs, it usually can be solved quite easily when the cause is found by using the checklist below. If not please call the Customer Care Line on **0330 026 2626**.

⚠ CAUTION ⚠
**TO REDUCE THE RISK OF PERSONAL INJURY - UNPLUG BEFORE
 CLEANING OR SERVICING.**

PROBLEM	POSSIBLE SOLUTION
Why won't the carpet washer turn on?	It may not be plugged into the electrical socket correctly: ensure that the plug is pushed in securely and switched on.
	The power button on the carpet washer may not be fully depressed.
	Check the fuse in the plug and if this needs replacing always replace with a 13 amp fuse.
Why won't the carpet washer pick up solution/spills?	The float in the dirty water tank may have been activated. Empty the dirty water tank if full. If the dirty water tank is not full switch the carpet washer off and wait for the float to settle before re-starting.
	Ensure the dirty water tank is fitted correctly and nozzle cleaning door is closed.
	Check the nozzle for blockages.
	Check the brushbar for blockages.
Why won't the solution/clean water dispense?	Ensure the clean water tank is fitted securely.
	The solution/clean water tank may be empty.
Why won't the brushes rotate?	The brushes may not have been activated, switch the brushbar button to 'on'.
	Belt may have broken, check and replace.
	Check the brushbar for blockages.

GUARANTEE



LIMITED GUARANTEE

It's quick and easy to register for your free 1 year guarantee online at www.dirtdevil.co.uk.

Please retain your original receipt for proof of purchase.

Please make a note of the serial number and model number of the product before calling.



**Call our Customer
Service Department at**

0330 026 2626

Monday-Friday 9:00am to 5:00pm.

www.DirtDevil.co.uk

Dirt Devil, 2 Colmore Square, 38 Colmore Circus, Queensway, Birmingham, B4 6BN.



EEC Statement of Compliance: Manufacturer/EEC importer: Vax Limited trading as Dirt Devil, hereby on our own responsibility, declare that the DDW02-E01/R01 series is manufactured in compliance with the following Directives:
Safety: 2006/95/EC Low Voltage Directive. **EMC:** 2004/108/EC Electromagnetic Compatibility Directive.



Waste electrical products should not be disposed of with household waste. Please recycle where facilities exist. Check with your Local Authority or retailer for recycling advice.