

SONY[®]

User guide

SmartBand Talk
SWR30

Contents

| | |
|---|-----------|
| Basics..... | 3 |
| Introduction..... | 3 |
| Hardware overview..... | 3 |
| Understanding the display..... | 4 |
| Interacting with the SmartBand Talk..... | 4 |
| Charging your SmartBand Talk..... | 4 |
| Assembly..... | 5 |
| Turning on and off..... | 6 |
| Still mode..... | 6 |
| Setting up your SmartBand Talk..... | 7 |
| Preparing to use your SmartBand Talk..... | 7 |
| Reconnecting your SmartBand Talk..... | 8 |
| Resetting your SmartBand Talk..... | 8 |
| Settings for your SmartBand Talk..... | 9 |
| Using the SmartBand Talk application..... | 9 |
| Controlling applications with your SmartBand Talk..... | 9 |
| SmartBand Talk alarm..... | 10 |
| Notifications..... | 11 |
| Handling calls..... | 13 |
| Do not disturb..... | 13 |
| Power management..... | 14 |
| Wearing style..... | 14 |
| Display colour..... | 15 |
| Sleep tracking..... | 15 |
| Google Fit..... | 15 |
| Voice search..... | 16 |
| Locating your SmartBand Talk..... | 16 |
| Selecting a watch face for your SmartBand Talk..... | 16 |
| Logging your activities using the Lifelog application..... | 18 |
| Using the Lifelog application..... | 18 |
| Setting goals..... | 20 |
| Logging sleep with your SmartBand Talk..... | 20 |
| Creating life bookmarks..... | 20 |
| Synchronising data with the Lifelog application..... | 21 |
| Important information..... | 22 |
| Using your SmartBand Talk in wet and dusty conditions..... | 22 |
| Legal information..... | 23 |

Basics

Introduction

The SmartBand Talk is both a standalone device as well as a companion product that connects wirelessly via Bluetooth® with Android™ smartphones and tablets. Worn on your dominant wrist, it can monitor your body movements and interact with your Android™ device to generate data about your daily life and habits. For example, the SmartBand Talk counts your steps and records data about your physical state while you sleep, walk or run. Together with the Lifelog application, you can set personal goals and then track your progress in a comprehensive and easily viewable format.

The accessory also helps you to stay organised and manage common day-to-day tasks. For example, you can use it to handle alarms, phone calls and text messages, and to record voice notes. And with dozens of applications available for your SmartBand Talk on Google Play™, you can add new features regularly.

Before you can get started using your SmartBand Talk, you must download the SmartBand Talk application and set up the accessory to work with your phone or tablet. Refer to the relevant setup information for more details. Also, remember that your Android™ device must run the Android™ software version 4.4 or higher and support the Bluetooth® version 3.0 profile.

Hardware overview

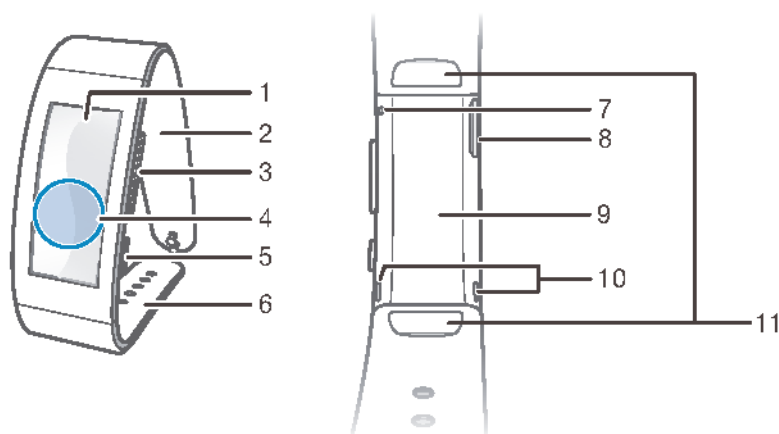

| | |
|----|------------------------|
| 1 | Screen |
| 2 | Wristband strap 1 |
| 3 | Volume key |
| 4 | NFC detection area |
| 5 | Power key/Function key |
| 6 | Wristband strap 2 |
| 7 | Microphone |
| 8 | Micro USB port |
| 9 | Core unit |
| 10 | Speakers |
| 11 | Attachment clips |

Understanding the display

Your SmartBand Talk features an E Ink® display that uses electronic ink technology to reproduce the appearance of ordinary ink on paper. In an E Ink® display, no backlight is used. Instead, ambient light from the environment is reflected from the surface of the display, making it more comfortable to read. The image on your E Ink® screen is retained even when power to the screen is turned off. Also note that when the content displayed on the screen changes, there is a brief transition time. This is normal E Ink® display behavior.

Interacting with the SmartBand Talk

You can control applications by firmly tapping the SmartBand Talk and you can navigate from screen to screen by pressing the function key. If the screen is idle for 30 seconds, the idle mode screen becomes active.

Tapping

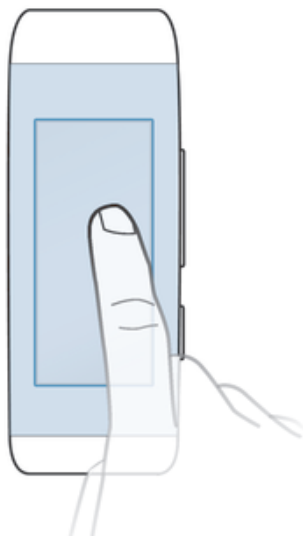

- Handle installed applications, for example, add bookmarks.
- ! The display of the SmartBand Talk is not touch sensitive. Remember to firmly tap the SmartBand Talk in order for the device to register a command. Also note that the screen does not recognise swiping movements.

Function key

You can use the function key to navigate between different screens and applications.

To navigate from one screen to another

- Short press the function key.

To exit an application

- Long press the function key. After the application closes, the idle mode screen becomes active.

Charging your SmartBand Talk

Before using your SmartBand Talk for the first time, you need to charge it for approximately 30 minutes. Sony chargers are recommended.

If your SmartBand Talk is not used during charging, it takes 45 to 70 minutes to fully charge it depending on the type of charger used.

To charge your SmartBand Talk

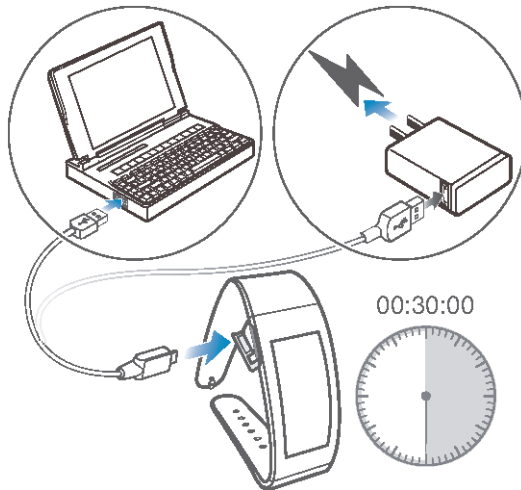

- 1 Plug one end of the USB cable into the charger or into the USB port of a computer.
 - 2 Plug the other end of the cable into the Micro USB port of your SmartBand Talk.
- 💡 If you are charging the device for the first time, make sure you charge it for at least 30 minutes.

To check the battery level of your SmartBand Talk

- From the main application screen of your Android™ device, find and tap **SmartBand™ Talk > STATUS**.

Low battery level notification

When your SmartBand Talk is on and the battery level goes below 15 percent, it emits one short vibration and a warning notification appears on the screen to indicate that the battery is low. The warning gets repeated when the battery reaches charge levels of 10 and 5 percent, respectively. 🔋 displays permanently on your SmartBand Talk when the battery runs out of power, indicating that you need to charge it.

To dismiss a battery warning notification

- Short press the function key.

Assembly

To personalise your SmartBand Talk, you can replace the wristband with bands of different colour and length, which can be purchased separately.

- ! When you change the wristband, you may also have to replace the attachment clips with clips of a suitable size or type.

To remove the wristband

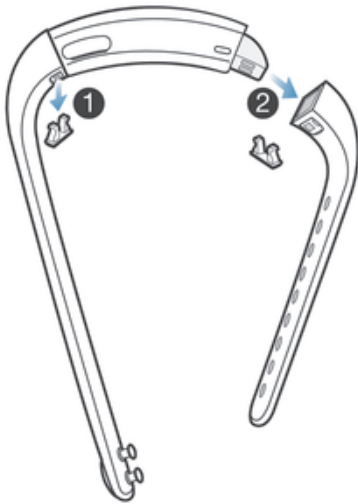

- 1 Insert a fingernail, or a similar object, into the gap near each attachment clip, then drag out and fully remove the clips.
- 2 Remove the wristband straps from the core unit of the accessory.

Turning on and off

To turn on your SmartBand Talk

- Press and hold down the power key until the device vibrates.

To turn off your SmartBand Talk

- Press and hold down the power key until your SmartBand Talk vibrates and the screen goes blank.

Still mode

Your SmartBand Talk has a feature called Still mode. When your SmartBand Talk is absolutely still and does not receive any notifications or calls for 20 minutes, it enters Still mode and the screen goes blank. As soon as your SmartBand Talk is moved or receives an incoming call or notification, it exits Still mode automatically.

- ! Still mode is enabled on your SmartBand Talk by default and cannot be set or turned off.

Setting up your SmartBand Talk

Preparing to use your SmartBand Talk

For your SmartBand Talk to work properly, you must install the latest version of the SmartBand Talk application on the Android™ device, and then pair and connect it with your Android™ device. You also need to install the Lifelog application, which adds extra features and functions that allow you to, for example, see more detailed information about your daily activities.

You can set up your SmartBand Talk using NFC, which launches the pairing, connection and setup procedures automatically, or you can use the manual Bluetooth® option which requires some extra steps, for example, to download and install some necessary applications.

A setup wizard in the SmartBand Talk application guides you through the process of setting up your SmartBand Talk for the first time.

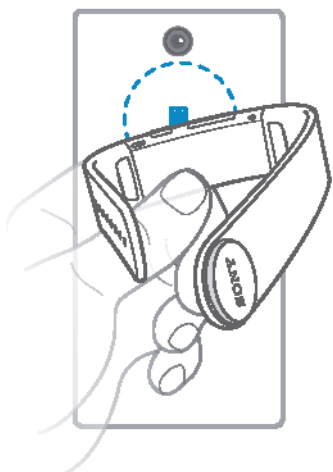

- ! All applications required for the SmartBand Talk to work are available on Google Play™.

To set up your SmartBand Talk using NFC



- 1 Make sure that your SmartBand Talk has been charged for at least 30 minutes.
 - 2 Android™ device: Make sure that the NFC function is turned on and that the screen is active and unlocked.
 - 3 Place the Android™ device over your SmartBand Talk so that the NFC area of each device touches the other.  appears briefly in the status bar and permanently in the Notification panel when a connection with the SmartBand Talk is active.
- ! You can set up your SmartBand Talk using NFC even when the SmartBand Talk is turned off.
 - 💡 You can drag down the status bar to open the Notification panel and get quick access to the SmartBand application and the Lifelog application.

To set up your SmartBand Talk using Bluetooth®

- 1 Make sure that your SmartBand Talk has been charged for at least 30 minutes.
 - 2 Android™ device: Make sure that you have installed or updated the SmartBand Talk application to the latest version.
 - 3 Turn on your SmartBand Talk.
 - 4 Android™ device: Turn on the Bluetooth® function, then scan for Bluetooth® devices and select **SWR30** in the list of available devices.
 - 5 Android™ device: Follow the instructions that appear on the screen.  appears briefly in the status bar and permanently in the Notification panel when a connection with the SmartBand Talk is active.
-  You can drag down the status bar to open the Notification panel and get quick access to the SmartBand application and the Lifelog application.

To install the SmartBand Talk application

- 1 From the main application screen of your Android™ device, find and tap **Play Store** to open the **Google Play™** application.
 - 2 Tap the search icon, then search for “SmartBand Talk”.
 - 3 After the search results appear, tap **SmartBand™ Talk**, then follow the relevant instructions to download and install the application.
-  You can only install the **SmartBand™ Talk** application on an Android™ device, for example, an Android™ smartphone or tablet.

Reconnecting your SmartBand Talk

In cases where a connection gets lost, for example, when the connected Android™ device goes out of range, your SmartBand Talk automatically performs a series of reconnection attempts. When this happens, you can use the function key to force the accessory to try reconnecting, or you can use NFC to reconnect the two devices.

To force the SmartBand Talk to try reconnecting

- Press the function key.

To reconnect your SmartBand Talk using NFC

- 1 Android™ device: Make sure that the NFC function is turned on and that the screen is active and unlocked.
- 2 Place the Android™ device over your SmartBand Talk so that the NFC detection area of each device touches the other.

Resetting your SmartBand Talk

Reset your SmartBand Talk if it behaves unexpectedly or if you want to connect it to a new device.

To perform a factory data reset

- 1 Turn off your SmartBand Talk.
- 2 Press and hold down the power key, volume up and down keys simultaneously until you feel three short vibrations followed by one longer vibration, then release the keys.

-  You need to pair the SmartBand Talk with your Android™ device again.

To force your SmartBand Talk to shut down

- Long press the power key.

Settings for your SmartBand Talk

Using the SmartBand Talk application

You can view and change settings for your SmartBand Talk by using the SmartBand Talk application on your Android™ device.

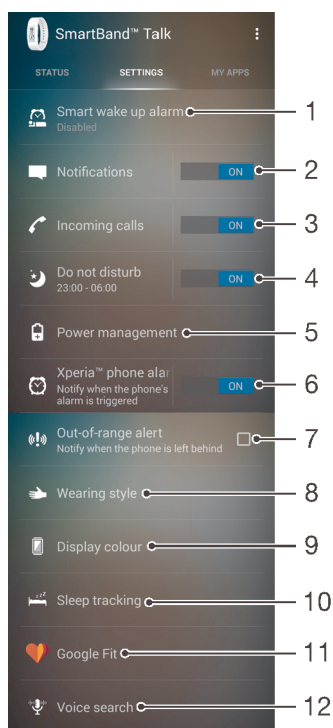

- 1 Turn smart wake up alarms on or off as well as add, edit or delete them.
- 2 Turn the notifications function on or off.
Select which notifications to forward to your SmartBand Talk.
- 3 Select whether you want to handle incoming calls using your SmartBand Talk.
- 4 Turn the “do not disturb” function on or off, or change the interval time.
- 5 Turn STAMINA mode on or off.
- 6 Enable Xperia™ phone alarm notifications.
- 7 Select to get notified when you leave your device behind.
- 8 Set the text orientation.
- 9 Select the display background colour.
- 10 Select the sleep tracking type.
- 11 Synchronise your SmartBand Talk with the Google Fit application.
- 12 Open the Android™ voice input settings to change the language and other options.

💡 You can tap or drag the relevant slider to the on or off position depending on whether you want to receive notifications and incoming calls or activate the “do not disturb” and other functions. You can also tap on the name of each function to view more information about how to adjust related settings.

Controlling applications with your SmartBand Talk

You can add up to nine applications at a time for use with your SmartBand Talk. You can then use your SmartBand Talk to control how the selected applications function on the connected Android™ device. For example, if you add the relevant media

player application, you can use the SmartBand Talk to control the playback of media files on the connected Android™ device. For each added application, you can edit the settings at any time.

To select an application for use with your SmartBand Talk

- 1 From the main application screen of your Android™ device, find and tap **SmartBand™ Talk > MY APPS > ADD APPS**.
- 2 Touch and hold the application that you want to select, then drag it to position under “Add apps” and follow the on-screen instructions.
- 3 To download more applications, tap **GET MORE APPS**, then follow the download instructions.

To rearrange the list of selected applications

- 1 From the main application screen of your Android™ device, find and tap **SmartBand™ Talk > MY APPS**.
- 2 Touch and hold the application that you want to move, then drag it to the desired position.

To edit settings for a selected application

- 1 From the main application screen of your Android™ device, find and tap **SmartBand™ Talk > MY APPS**.
- 2 Select an application, then edit the settings as desired.

To remove a selected application

- 1 From the main application screen of your Android™ device, find and tap **SmartBand™ Talk > MY APPS**.
- 2 Touch and hold the application that you want to delete, then drag it to **X**.

SmartBand Talk alarm

Your SmartBand Talk has two different alarm functions. One is the Xperia™ phone alarm function, which only works when your SmartBand Talk is connected to an Xperia™ device. The other is the smart wake up function, which wakes you up within a selected time frame after you have reached a state of light sleep so that you wake up feeling refreshed. The smart wake up function works whether an Android™ device is connected or not.

Alarm notifications from an Xperia™ device

Your SmartBand Talk vibrates when pre-set alarms go off on a connected Xperia™ device.

To enable alarm notifications from an Xperia™ device

- 1 From the main application screen of your Xperia™ device, find and tap **SmartBand™ Talk > SETTINGS**.
- 2 Drag the slider beside **Xperia™ phone alarm** to the right.
- 3 Tap **Xperia™ phone alarm > Alarm sound and vibration** and select an option.

To snooze an alarm on your Xperia™ device when your SmartBand Talk vibrates

- Short press the function key.

To turn off an alarm when your SmartBand Talk vibrates

- Long press the function key.

Smart wake up alarms

You can set one or several smart wake up alarms in the SmartBand Talk SWR30 application. The smart wake up alarm wakes you up at the best time based on your sleep cycle. The alarm notifies you with a continuous vibration. After you set a time frame for when you would like to be awoken by the alarm, your SmartBand Talk

registers when you have reached a state of light sleep (after a period of deep sleep) and then wakes you up.

For example, if you set a smart wake up alarm for between 06:30 and 07:00 AM, the alarm wakes you up sometime between 06:30 and 07:00 AM when you reach a state of light sleep. If you do not reach a state of light sleep during this period, the smart wake up alarm wakes you up at 07:00 AM.

- ! If you want to add, remove or change a smart wake up alarm, your SmartBand Talk must be connected to the Android™ device.

To add a smart wake up alarm

- 1 From the main application screen of your Android™ device, find and tap **SmartBand™ Talk > SETTINGS**.
 - 2 Tap **Smart wake up alarm**, then tap **+**.
 - 3 Tap **Time**, then scroll up or down to adjust the time and tap **Set**.
 - 4 Tap **Repeat**, then mark the days on which you want the alarm to recur and tap **OK**.
 - 5 Tap **Alarm window** and select an option.
 - 6 Mark the **Alarm sound** checkbox if you want a sound alert.
 - 7 When you're finished, tap **Done**.
- 💡 If the **Alarm sound** checkbox is checked, the volume of the alarm sound on your SmartBand Talk starts low and then increases gradually.

To edit an existing smart wake up alarm

- 1 From the main application screen of your Android™ device, find and tap **SmartBand™ Talk > SETTINGS**.
- 2 Tap **Smart wake up alarm**, then tap the alarm that you want to edit.
- 3 Edit the options as desired.
- 4 When you're finished, tap **Done**.

To delete a smart wake up alarm

- 1 From the main application screen of your Android™ device, find and tap **SmartBand™ Talk > SETTINGS**.
- 2 Tap **Smart wake up alarm**, then touch and hold the alarm that you want to delete.
- 3 Tap **X**, then tap **Yes**.

To turn on a smart wake up alarm

- 1 From the main application screen of your Android™ device, find and tap **SmartBand™ Talk > SETTINGS**.
- 2 Tap **Smart wake up alarm**.
- 3 Scroll to the alarm that you want to turn on, then drag the relevant slider switch to the right.

Notifications

All notifications that appear in the status bar on a connected Android™ device can be forwarded to your SmartBand Talk. You can use the SmartBand Talk application to select which notifications to forward.

Depending on the message type, you can read a message preview or the full message by firmly tapping your SmartBand Talk. You can also perform actions such as “Open in phone”, “Mark as read”, “Block”, “Dismiss” and so on.

To turn on the notification function

- 1 From the main application screen of your Android™ device, find and tap **SmartBand™ Talk > SETTINGS**.
- 2 Drag the slider beside **Notifications** to the right.
- 3 If you are turning on the notifications function for the first time, follow the instructions that appear on the screen to give the SmartBand Talk application access to your notifications.

To select which notifications to forward to your SmartBand Talk

- 1 From the main application screen of your Android™ device, find and tap **SmartBand™ Talk > SETTINGS > Notifications**.
- 2 Tap **Get notification from**.
- 3 In the list that appears, mark or unmark the desired options.

To hide sender's name from notification message on your SmartBand Talk

- 1 From the main application screen of your Android™ device, find and tap **SmartBand™ Talk > SETTINGS > Notifications**.
- 2 Mark the **Privacy** checkbox.

To select the notification text size on your SmartBand Talk

- 1 From the main application screen of your Android™ device, find and tap **SmartBand™ Talk > SETTINGS > Notifications**.
- 2 Tap **Notification text size**, then select an option.

To read a notification displayed on the screen of your SmartBand Talk

- 1 Firmly tap the notification or short press the volume down key to open it.
- 2 Short press the volume up or down key to scroll through the notification.

To read a notification from the Notification extension of your SmartBand Talk

- 1 Short press the function key to navigate to the Notification extension.
- 2 Short press the volume up or down key to highlight the notification that you want to read.
- 3 Firmly tap the highlighted notification to open it.
- 4 Short press the volume up or down key to scroll through the notification.

To close or exit a notification on your SmartBand Talk

- Short press the function key.

To dismiss all notifications from the Notification extension

- 1 Short press the function key to navigate to the Notification extension.
- 2 Short press the volume down key to highlight the item "Dismiss all notifications".
- 3 Firmly tap the highlighted "Dismiss all notifications".

Notification actions on your SmartBand Talk

You can perform specific actions after receiving notifications forwarded to your SmartBand Talk. The actions available after receiving a notification depends on the type of application that sends the notification. The following lists the most common actions that you can perform:

- **Mark as read:** Mark a notification as read in the notifying application, and then remove it from the notification list in your SmartBand Talk and the status bar in the connected Android™ device.
- **Reply:** Reply to a message with a short voice to text reply (about 5 seconds) or with the pre-defined quick replies using your SmartBand Talk.
- **Open in phone:** Open a notification and the related application in the connected Android™ device.
- **Block:** Block the related application from forwarding the notifications to your SmartBand Talk.

- Dismiss: Clear a notification from the notification list in your SmartBand Talk and the status bar in the connected Android™ device.

To perform an action to an open notification using your SmartBand Talk

- 1 Short press the volume up or down key to highlight the action that you want to perform.
- 2 Firmly tap the highlighted action, and follow the on-screen instructions if there are any.

Handling calls

Your SmartBand Talk notifies you with continuous vibrations when a call comes in. You can choose to answer the call on your Android™ device or to answer and handle it directly on your SmartBand Talk by speaking into the microphone of the device. You can also use your SmartBand Talk to reject an incoming call and hang up on an ongoing call. To handle calls and receive call notifications directly on your SmartBand Talk, you must first enable the relevant settings in the SmartBand Talk application.

To enable your SmartBand Talk to receive incoming call

- 1 From the main application screen of your Android™ device, find and tap **SmartBand™ Talk > SETTINGS**.
- 2 Drag the slider beside **Incoming calls** to the right.

To answer an incoming call using your SmartBand Talk

- 1 When the call comes in, short press the function key. The voice of the caller can be heard through the speakers on your SmartBand Talk.
- 2 To talk to the caller, hold the accessory with a 20 cm range of your mouth and speak into the microphone.

- If you want to answer the incoming call using your handset, you can select the option on the ongoing call screen of your Android™ device, then the call is in the device you chose to answer with.

To reject an incoming call using your SmartBand Talk

- Long press the function key.

To silence an incoming call using your SmartBand Talk

- Long press the volume key up or down.

To hang up on an ongoing call using your SmartBand Talk

- Short press the function key.

To mute or unmute an ongoing call using your SmartBand Talk

- During the call, long press the function key.

Do not disturb

You can turn off the notifications and events sounds or vibrations by turning on the “do not disturb” function. But when this function is on, the alerting functions, such as the smart wake up alarm, the Xperia™ phone alarm and locating SmartBand Talk function, remain activated.

To turn on the “do not disturb” function

- 1 From the main application screen of your Android™ device, find and tap **SmartBand™ Talk > SETTINGS**.
- 2 Drag the slider beside **Do not disturb** to the right.

To set the “do not disturb” interval

- 1 From the main application screen of your Android™ device, find and tap **SmartBand™ Talk > SETTINGS > Do not disturb.**
- 2 Drag the slider beside **Do not disturb** to the right.
- 3 Tap **Repeat.**
- 4 Tap the start time, then scroll up or down to edit accordingly and tap **Set.**
- 5 Tap the end time, then scroll up or down to edit accordingly and tap **Set.**
- 6 Tap **Done.**

Power management

To extend the battery life of your SmartBand Talk, you can activate STAMINA mode from the settings. When this mode is activated, diagonal lines overlap the screen and the STAMINA mode icon  appears in the top right corner of your SmartBand Talk. In STAMINA mode, several functions are disabled and you can't perform the following:

- Receive calls on your SmartBand Talk.
- Forward notifications to your SmartBand Talk.
- Get notified when your SmartBand Talk and your Android™ device are out of the connection range.

However, the activity logging and the smart wake up functions still work as normal.

To activate STAMINA mode

- 1 From the main application screen of your Android™ device, find and tap **SmartBand™ Talk > SETTINGS.**
- 2 Tap **Power management.**
- 3 Drag the slider beside **STAMINA mode** to the right.

To deactivate STAMINA mode

- 1 From the main application screen of your Android™ device, find and tap **SmartBand™ Talk > SETTINGS.**
- 2 Tap **Power management.**
- 3 Drag the slider beside **STAMINA mode** to the left.
- 4 Short press the function key of your SmartBand Talk.

To temporarily deactivate STAMINA mode

- Short press the function key.

- ! When you temporarily disable STAMINA mode on your SmartBand Talk, all functions are available as normal. If no activity is performed on your SmartBand Talk for 20 seconds, it reverts to an idle screen and returns to STAMINA mode.

To activate low battery mode

- 1 From the main application screen of your Android™ device, find and tap **SmartBand™ Talk > SETTINGS.**
- 2 Tap **Power management.**
- 3 Drag the slider beside **Low battery mode** to the right.

- 💡 When low battery mode is on, your SmartBand Talk enters STAMINA mode automatically when its battery is low.

Wearing style

You can set the display orientation of your SmartBand Talk according to which arm you wear it on.

To select the display orientation

- 1 From the main application screen of your Android™ device, find and tap **SmartBand™ Talk > SETTINGS**.
- 2 Tap **Wearing style**, then select an option.
- 3 Tap **OK**.

Display colour

You can change the display colour for your SmartBand Talk from black to white, or vice versa.

To change the display colour

- 1 From the main application screen of your Android™ device, find and tap **SmartBand™ Talk > SETTINGS**.
- 2 Tap **Display colour**, then select an option.
- 3 Tap **OK**.

Sleep tracking

Your SmartBand Talk tracks your sleep status based on a certain type of inactivity. To improve the sleep tracking accuracy, you can choose the sleep tracking type, in case that your SmartBand Talk mistakenly records all your inactivity status as sleep period. For example, if you keep still when you watch TV or read books before going to sleep.

To activate the automatic sleep tracking

- 1 From the main application screen of your Android™ device, find and tap **SmartBand™ Talk > SETTINGS**.
 - 2 Tap **Sleep tracking > Automatic sleep tracking**.
- ! Automatic sleep tracking is the default mode of the sleep tracking function.

To customise the sleep tracking period

- 1 From the main application screen of your Android™ device, find and tap **SmartBand™ Talk > SETTINGS**.
- 2 Tap **Sleep tracking > Custom sleep tracking > Only track sleep between**.
- 3 Tap the start time, then scroll up or down to edit accordingly and tap **Set**.
- 4 Tap the end time, then scroll up or down to edit accordingly and tap **Set**.
- 5 Tap **Done**.

Google Fit

Google Fit is a health-tracking platform developed by Google. By synchronising your SmartBand Talk with Google Fit, you can easily integrate data about your fitness activities from various sources to help you better understand your progress.

When you activate Google Fit on your SmartBand Talk, the data logged by your SmartBand Talk can be viewed in the Google Fit application, which can be downloaded from Google Play™.

- ! Your SmartBand Talk is optimised for use with the Lifelog application so that both interfaces display the same data about your fitness activities. However, due to different programming and different synchronisation intervals, the data displayed in the Google Fit application may differ from the data shown on your SmartBand Talk and in the Lifelog application. It's recommended to use the application that best suits your needs.

To synchronise your SmartBand Talk with the Google Fit application

- 1 From the main application screen of your Android™ device, find and tap **SmartBand™ Talk > SETTINGS > Google Fit**.
- 2 Drag the slider beside **Connect to Google Fit** to the right.

Voice search

You can use voice commands to reply to a message, determine your location, check the weather report, confirm your schedule and so on. Voice search forwards the search commands to the default voice search application of the connected Android™ device. Voice search availability and its supported languages depend on the voice search application installed on the connected Android™ device. To use the voice search function in your SmartBand Talk, you must install a voice search application, such as Google Now, on your Android™ device first.

To set the voice input options

- 1 From the main application screen of your Android™ device, find and tap **SmartBand™ Talk > SETTINGS > Voice search**.
 - 2 Tap **Settings**, and follow the on-screen instructions and options.
- ! You should restart your Android™ device if the voice search language is changed.

To trigger voice search

- 1 Navigate to the home screen.
 - 2 Hold and press the volume up key for about 2 seconds until the speaker image appears on the screen.
 - 3 Speak a command after you hear the “beep” sound.
- ! Your SmartBand Talk reverts to the home screen after the voice command has been accepted or when an error occurs.

Locating your SmartBand Talk

In case you forget where you left it, you can locate your SmartBand Talk by activating the ringer remotely.

To use the remote ring function

- 1 From the main application screen of your Android™ device, find and tap **SmartBand™ Talk > STATUS**.
- 2 Tap **LOCATE SMARTBAND™**. Your SmartBand Talk starts to ring loudly.
- 3 To stop the ringing, press any key on your SmartBand Talk or tap **Stop sound alert** on your Android™ device.

Selecting a watch face for your SmartBand Talk

You can select from several different types of watch faces for your SmartBand Talk and customise them. You can select what types of information are displayed for each watch face you set. You can choose information such as the date, temperature or weather. In addition, you can select the background image of the watch face from the album of the Android™ device connected to your SmartBand Talk.

To select a watch face for your SmartBand Talk

- 1 From the main application screen of your Android™ device, find and tap **SmartBand™ Talk > MY APPS**.
- 2 Tap **SELECT WATCH FACE**, then select a watch face.
- 3 If you want to change the display format for the watch face, tap **X** and select an option.

To select an image for the watch face

- 1 From the main application screen of your Android™ device, find and tap **SmartBand™ Talk > MY APPS**.
 - 2 Tap **SELECT WATCH FACE > Custom image > ✂**.
 - 3 Tap **SELECT IMAGE**, and then select an image.
 - 4 Adjust the position and the size of the marquee to crop the image, and then tap **Crop**.
- ! The SmartBand Talk application uses the default image picker installed in your Android™ device to crop images, so the user interface for editing or selecting an image may differ between devices.

Logging your activities using the Lifelog application

Using the Lifelog application

The Lifelog application records your physical, social and entertainment activities. For example, you can see if you've been walking or running and how you communicate with your friends. You can also see what pictures you took and what music you listened to. To start using the Lifelog application, you need to download it from Google Play™ and then set up an account.

- ! The statistics that the Lifelog application generates from your physical activities, for example, walking distance and calorie count, are based on the height and weight data you provide. Results may vary from user to user. Also, remember that you need an active Internet connection to synchronise data to the Lifelog application on your Android™ device.

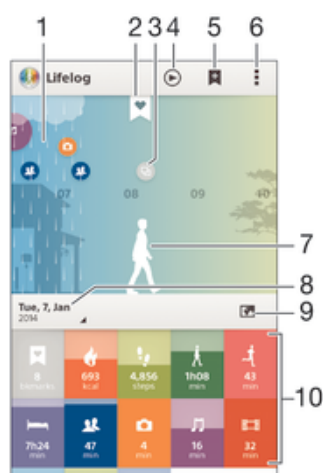

- 1 Show all logged activities and life bookmarks
- 2 View detailed information about a life bookmark
- 3 View information about application usage
- 4 View all logged activities since the start of the day
- 5 Add a life bookmark
- 6 View menu options
- 7 Physical activities log
- 8 View all logged activities for the selected day
- 9 Switch between dashboard and map view
- 10 Activities dashboard

To set up an account for the Lifelog application

- 1 From the **Home screen** of your Android™ device, tap , then find and tap **Lifelog**.
- 2 Follow the instructions that appear on the screen and accept the terms and conditions.
- 3 Create a new account or select to use an existing one. Sony PlayStation® Network accounts can also be used.
- 4 Follow the instructions that appear on the screen to create a Lifelog account.



To log in to the Lifelog application

- 1 From the **Home screen** of your Android™ device, tap , then find and tap **Lifelog**.
- 2 Follow the instructions that appear on the screen and accept the terms and conditions.



Adjusting the stride length for walking and running

The Lifelog application uses the number of steps you have taken and your stride length to calculate the distance you have walked or run. The automatic stride length used by default is based on your gender and height. If you feel that the distances measured by the Lifelog application are not accurate enough, you can adjust your stride length.

To adjust the stride length for walking

- 1 From the **Home screen** of your Android™ device, tap , then find and tap **Lifelog**.
- 2 Tap  > **Settings** > **Profile**.
- 3 Find and tap **Stride length**.
- 4 Unmark the **Automatic** checkbox if it is marked, then scroll up or down to adjust the setting and tap **Set**.

To adjust the stride length for running

- 1 From the **Home screen** of your Android™ device, tap , then find and tap **Lifelog**.
- 2 Tap  > **Settings** > **Profile**.
- 3 Find and tap **Running stride length**.
- 4 Unmark the **Automatic** checkbox if it is marked, then scroll up or down to adjust the setting and tap **Set**.

Activity box overview

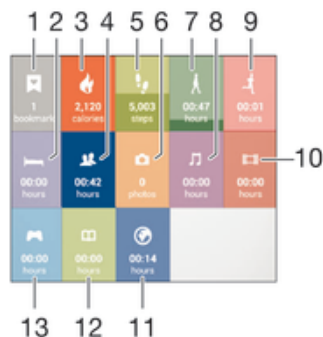

- 1 View all logged life bookmarks
- 2 View your sleep hours and check the quality of your sleep based on the information collected
- 3 View the amount of active calories that you have burned while exercising and the passive calories that you have burned while not exercising
- 4 View the time you have spent using communication applications from Google Play™ and some other applications such as the Phone and the Messaging applications from Sony
- 5 View the number of steps you have taken and logged in the Lifelog application
- 6 View how many photos you have taken
- 7 View the total time you have spent walking for longer than just a few steps
- 8 View the time you have spent listening to music using applications from Google Play™ and some other applications such as the "WALKMAN" application
- 9 View the total time you have spent running with a high steps-per-minute ratio for longer than just a few steps

- 10 View your total time spent watching movies, TV shows and other video content using applications from Google Play™ and some other applications
- 11 View your total time spent browsing while using applications from Google Play™ and some other web browsers
- 12 View your total time spent reading books or comics using applications from Google Play™ and some other applications
- 13 View your total time spent playing games using applications from Google Play™ and PlayStation® Store

Activity overview

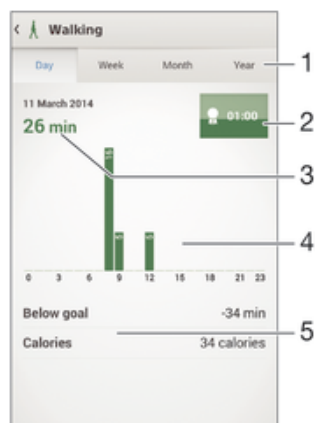

- 1 Show data in a day, week, month or year view
- 2 Show your current goal status
- 3 Show the current activity in different units
- 4 Show the amount of activity using the chosen unit type
- 5 Details about your activity

Setting goals

Set goals for activities in your daily life, for example, the number of steps to take, the distance you want to walk, or the amount of calories you want to burn.

To set a goal

- 1 In the Lifelog application, tap the activity that you want to set a goal for.
- 2 Tap **Day**, then tap the goal dashboard.
- 3 Scroll up or down to adjust the value for your goal, then tap **Set**.

Logging sleep with your SmartBand Talk

Your SmartBand Talk can log the hours you sleep, as well as the status for light sleep, deep sleep and your awake time during sleep hours, to help you understand your sleep quality. The data that your SmartBand Talk tracks is logged in the Lifelog application.

To view your sleep data

- In the Lifelog application, tap **Sleep** from the Activities dashboard.

Creating life bookmarks

Use your SmartBand Talk to create life bookmarks. Life bookmarks save information about time, location and audio notes, and help you remember special occasions. For location data to be gathered, you must have an active Internet connection.

To use the audio note feature, you must select the Life bookmark application for use with your accessory.

To create a life bookmark on an Android™ device using the Lifelog application

- 1 Android™ device: In the Lifelog application, tap .
- 2 Follow the on-screen instructions.
- 3 If necessary, add text notes, then tap **OK**.

To select the Life bookmark application for use with your SmartBand Talk

- 1 From the main application screen of your Android™ device, find and tap **SmartBand™ Talk > MY APPS**.
- 2 Tap **ADD APPS** and select **Life Bookmark**.

To create a life bookmark using your SmartBand Talk

- 1 Make sure that your SmartBand Talk is turned on and the Life bookmark application is enabled in the SmartBand Talk application on your Android™ device.
- 2 Using the function key, navigate to the Life bookmark screen.
- 3 To log the place and time, and to record an audio note, firmly tap  on the SmartBand Talk and speak into the SmartBand Talk. You can record 10 seconds of audio.

Synchronising data with the Lifelog application

When your SmartBand Talk is connected to your Android™ device, data gets synchronised automatically to the Lifelog application. When the SmartBand Talk gets disconnected from the Android™ device, it can continue to collect data until the memory becomes full. It's therefore recommended to synchronise data between the two devices regularly to free up memory on your SmartBand Talk.

Important information

Using your SmartBand Talk in wet and dusty conditions

Your SmartBand Talk is waterproof and dust tight in compliance with the Ingress Protection (IP) ratings IP65 and IP68, as explained in the table below.

These specific IP ratings mean that your SmartBand Talk is dust resistant and is protected against low pressure water stream as well as against the effects of immersion for 30 minutes in fresh (non-saline) water up to 1.5 metres deep.

You can use your SmartBand Talk:

- in dusty environments, for example, on a windy beach.
- when your fingers are wet.
- in some extreme weather conditions, for example, when it's snowing or raining.
- in fresh (non-saline) water depths of 1.5 metres or less, for example, in a fresh water lake or river.
- in a chlorinated swimming pool.

The unit should be rinsed with fresh water after use in chlorinated water.

After exposure to water, the acoustic performance of the device may be reduced until the sound output ports have dried out.

Even if your SmartBand Talk is resistant to dust and water, you should avoid exposing it unnecessarily to environments with excessive dust, sand and mud or to moist environments with extreme high or low temperatures. The waterproof ability of the micro USB port cannot be guaranteed in all environments or conditions.

Never immerse your SmartBand Talk in salt water or let the micro USB port come in contact with salt water. For example, if you're at the beach, remember to keep your SmartBand Talk away from the sea water. Also, never expose the SmartBand Talk to any liquid chemicals. For example, if you're washing dishes by hand using liquid detergent, avoid bringing your SmartBand Talk in contact with the detergent. After exposure to non-fresh water, rinse your SmartBand Talk using fresh water.

Normal wear and tear along with damage to your SmartBand Talk can reduce its ability to resist dust or moisture. After using the SmartBand Talk in water, dry off the areas around the micro USB port.

All compatible accessories, including batteries, chargers and micro USB cables, are not waterproof and dust resistant on their own.

Your warranty does not cover damage or defects caused by abuse or improper use of your SmartBand Talk (including use in environments where the relevant IP rating limitations are exceeded). If you have any further questions about the use of your accessory, refer to our Customer support service for help. To view more specific information about water resistance, go to support.sonymobile.com.

Ingress Protection Rating

Your SmartBand Talk has an IP rating, which means it has undergone certified tests to measure its resistance levels to both dust and water. The first digit in the two-digit IP rating indicates the level of protection against solid objects, including dust. The second digit indicates how resistant the device is to water.

| Resistance to solid objects and dust | Resistance to water |
|---|--|
| IP0X: No special protection | IPX0: No special protection |
| IP1X: Protected against solid objects > 50 mm in diameter | IPX1: Protected against dripping water |
| IP2X: Protected against solid objects > 12.5 mm in diameter | IPX2: Protected against dripping water when tilted up to 15 degrees from normal position |
| IP3X: Protected against solid objects > 2.5 mm in diameter | IPX3: Protected against spraying water |

| | |
|--|--|
| IP4X. Protected against solid objects > 1 mm in diameter | IPX4. Protected against splashing water |
| IP5X. Protected against dust; limited ingress (no harmful deposit) | IPX5. Protected against water jet spray for at least 3 minutes |
| IP6X. Dust tight | IPX6. Protected against heavy jet spray for at least 3 minutes |
| | IPX7. Protected against the effects of immersion in up to 1 metre of water for 30 minutes |
| | IPX8. Protected against the effects of continued immersion in water depths greater than 1 metre. The exact conditions are specified for each device by the manufacturer. |

Legal information

Sony SWR30



Prior to use, please read the *Important information* leaflet separately provided.

This User guide is published by Sony Mobile Communications Inc. or its local affiliated company, without any warranty. Improvements and changes to this User guide necessitated by typographical errors, inaccuracies of current information, or improvements to programs and/or equipment, may be made by Sony Mobile Communications Inc. at any time and without notice. Such changes will, however, be incorporated into new editions of this User guide.

All rights reserved.

©2015 Sony Mobile Communications Inc.

Interoperability and compatibility among Bluetooth® devices varies. Device generally supports products utilizing Bluetooth spec. 1.2 or higher, and Headset or Handsfree profile.

Sony is the trademark or registered trademark of Sony Corporation. Bluetooth is the trademark of the Bluetooth (SIG) Inc. and is used under license. All other marks are the property of their respective owners. All rights reserved.

All product and company names mentioned herein are the trademarks or registered trademarks of their respective owners. Any rights not expressly granted herein are reserved. All other trademarks are property of their respective owners.

Visit www.sonymobile.com for more information.

All illustrations are for illustration only and may not accurately depict the actual accessory.

Declaration of Conformity

We, Sony Mobile Communications AB of

Nya Vattentorget

SE-221 88 Lund, Sweden

declare under our sole responsibility that our product

Sony type **RD-0140**

and in combination with our accessories, to which this declaration relates is in conformity with the appropriate standards **EN 300 328:V1.8.1, EN 301 489-17:V2.2.1, EN 301 489-3:V1.6.1 and EN 60 950-1:2006 +A11:2009 +A1:2010+A12:2011+A12:2011** following the provisions of, Radio Equipment and Telecommunication Terminal Equipment directive 1999/5/EC.

Lund, July 2014

CE 0682



Pär Thuresson,
Quality Officer, SVP, Quality & Customer Services

FCC Statement

This device complies with Part 15 of the FCC rules. Operation is subject to the following two conditions: (1) This device may not cause harmful interference, and (2) This device must accept any interference received, including interference that may cause undesired operation.



Any change or modification not expressly approved by Sony may void the user's authority to operate the equipment.

This equipment has been tested and found to comply with the limits for a Class B digital device, pursuant to Part 15 of the FCC Rules. These limits are designed to provide reasonable protection against harmful interference in a residential installation. This equipment generates, uses and can radiate radio frequency energy and, if not installed and used in accordance with the instructions, may cause harmful interference to radio communications. However, there is no guarantee that interference will not occur in a particular installation.

If this equipment does cause harmful interference to radio or television reception, which can be determined by turning the equipment off and on, the user is encouraged to try to correct the interference by one or more of the following measures:

- Reorient or relocate the receiving antenna.
- Increase the separation between the equipment and receiver.
- Connect the equipment into an outlet on a circuit different from that to which the receiver is connected.
- Consult the dealer or an experienced radio/TV technician for help.

AVISO IMPORTANTE PARA MÉXICO

La operación de este equipo está sujeta a las siguientes dos condiciones: (1) es posible que este equipo o dispositivo no cause interferencia perjudicial y (2) este equipo o dispositivo debe aceptar cualquier interferencia, incluyendo la que pueda causar su operación no deseada.

Para consultar la información relacionada al número del certificado, refiérase a la etiqueta del empaque y/o del producto.

Alimentación: 5,0 Vcc

Industry Canada Statement

This device complies with RSS-210 of Industry Canada.

Operation is subject to the following two conditions: (1) this device may not cause interference, and (2) this device must accept any interference, including interference that may cause undesired operation of the device.

This Class B digital apparatus complies with Canadian ICES-003.

Cet appareil numérique de la classe B est conforme à la norme NMB-003 du Canada.

Avis d'industrie Canada

Le présent appareil est conforme aux CNR d'Industrie Canada applicables aux appareils radio exempts de licence.

L'exploitation est autorisée aux deux conditions suivantes: (1) l'appareil ne doit pas produire de brouillage, et, and (2) l'utilisateur de l'appareil doit accepter tout brouillage radioélectrique subi, même si le brouillage est susceptible d'en compromettre le fonctionnement.