

Bergen SHELF PACK

180 x 200 x 53cm

Assembly Instructions Please keep for future reference

238/6777

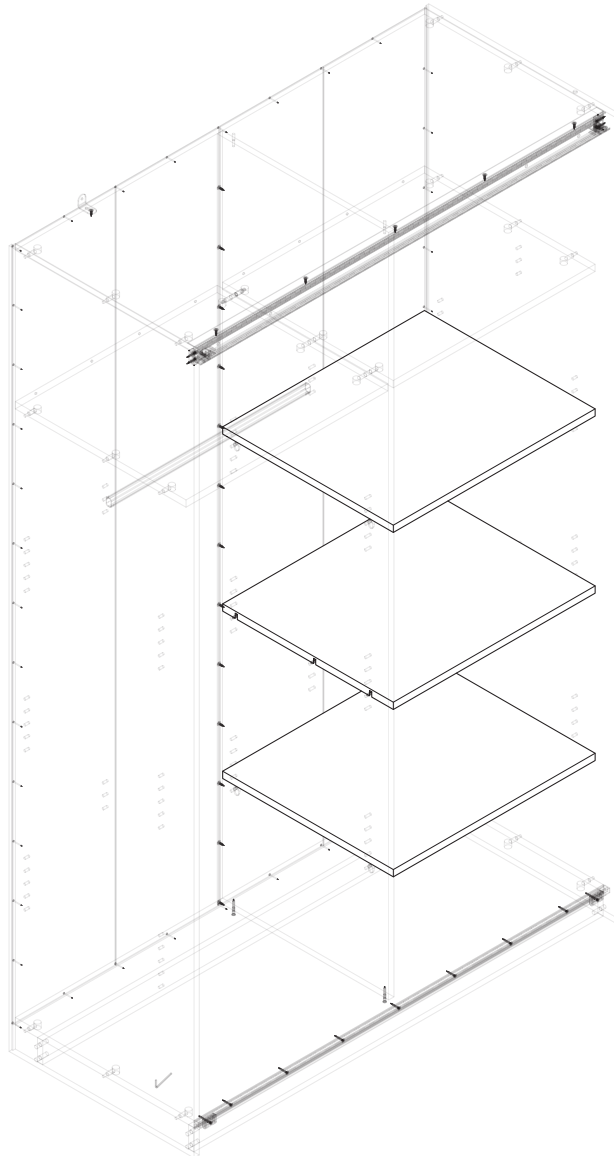

Dimensions

Width - 87.7cm

Depth - 48.8cm

Height - 1.8cm

Important – Please read these instructions fully before starting assembly

If you need help or have damaged or missing parts, please visit: www.argos-support.co.uk or email: Help@ClickSpares.co.uk (quoting your original order number)

Alternatively, call the Spares Helpline on: **0370 112 1928**

For any other queries please contact the Customer Helpline on: **0345 640 2020**





Safety and Care Advice

Important – Please read these instructions fully before starting assembly

- Check you have all the components and tools listed on the following pages.
- Remove all fittings from the plastic bags and separate them into their groups.
- Keep children and animals away from the work area, small parts could choke if swallowed.
- Make sure you have enough space to layout the parts before starting.

- During assembly do not stand or put weight on the product, this could cause damage.
- Assemble the item as close to its final position (in the same room) as possible.
- Assemble on a soft level surface to avoid damaging the unit or your floor.
- Parts of the assembly will be easier with 2 people.



- To reduce the likelihood of damaging your product please ensure that your power drill is set on a low torque setting.

Care and maintenance

- Only clean using a damp cloth and mild detergent, do not use bleach or abrasive cleaners.
- From time to time check that there are no loose screws on this unit.
- This product should not be discarded with household waste. Take to your local authority waste disposal centre.

Handy Hints

- Assemble all parts and bolts loosely during assembly, only once the product is complete should you fully tighten the bolts
- Regularly check and ensure that all bolts and fittings are tightened properly.

Note: if required the next page can be cut out and used as reference throughout the assembly. Keep this page with these instructions for future reference.

Components - Panels

For damaged or missing parts, please visit: www.argos-support.co.uk or email: Help@ClickSpares.co.uk

Please check you have all the panels listed below

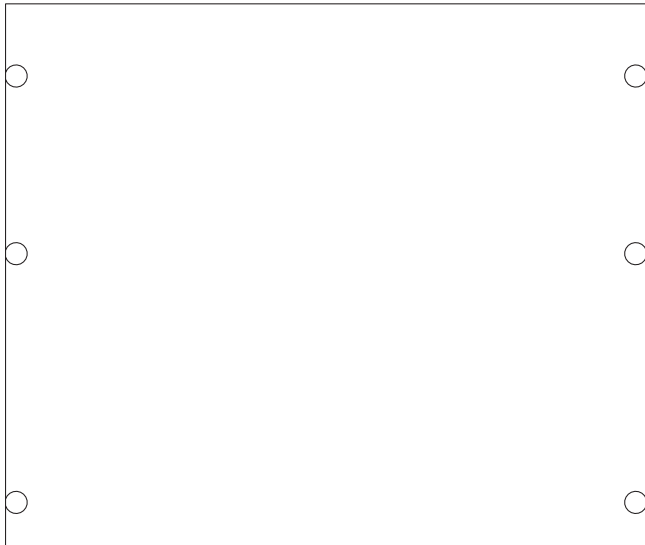

1 Horizontal
(87.7 x 48.8cm)
P1902

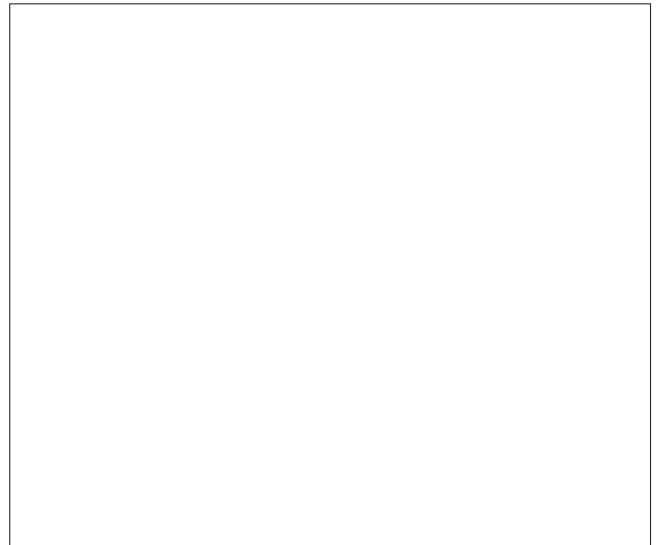





2 Shelf x 2
(87.7 x 48.8cm)
P1900

Components - Fittings

Please check you have all the fittings listed below

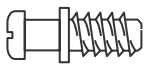
Note: The quantities below are the correct amount to complete the assembly. In some cases more fittings may be supplied than are required.

1/1

<p>A FK1056</p>  <p>Small locking screw x 6</p>	<p>B FK1051</p>  <p>Cam 20x12mm Expando housing x 6</p>	<p>C FK1207</p>  <p>Shelf support with fixinghole x 8</p>
<p>D FK1309</p>  <p>12,5mm Screw x 8</p>		

Tools required

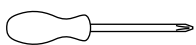

Phillips screwdriver
(medium & large)

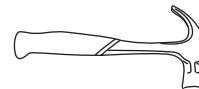

Small hammer

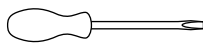

Flatblade screwdriver
(medium)

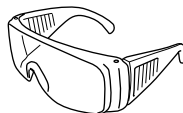

Eye protection
(when using a hammer or drill)

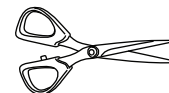

Scissors

Ruler - Use this ruler to help correctly identify the screws



The screws length is measured from the head to the point (30mm screw shown).

Assembly Instructions

Step 1

Insert the fittings

a:
change the place of one
hanging-rail as shown.

a:

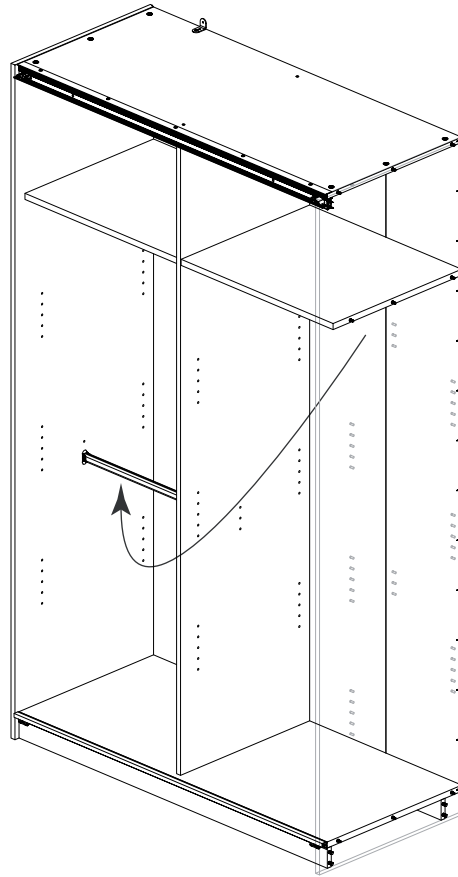

b:
Insert 6 small locking
screws **A** as shown.

b:

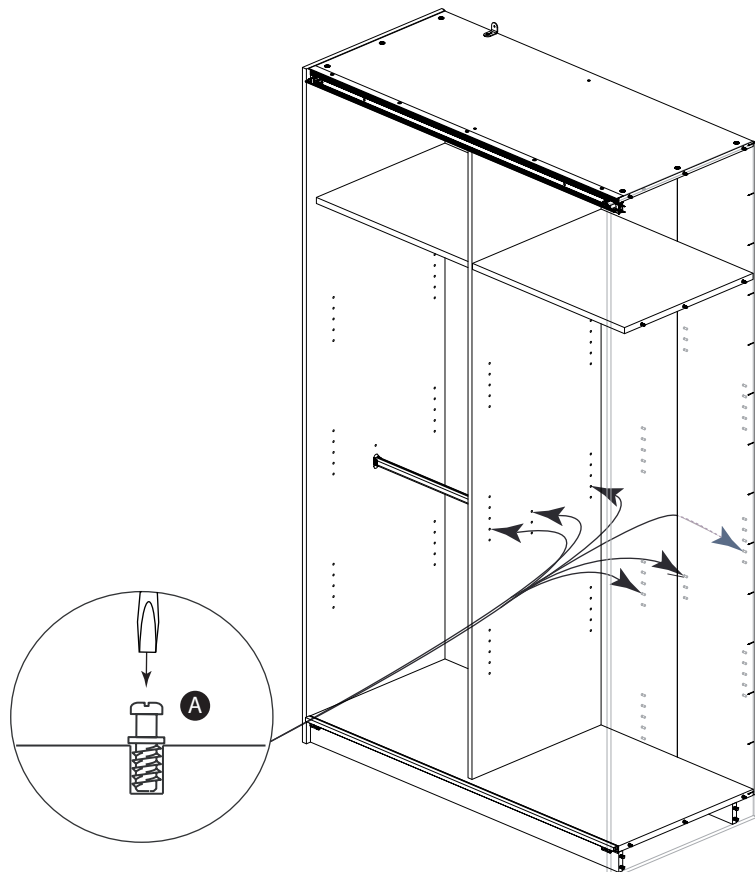

Assembly Instructions

Step 2

Inserting Horizontal

a: Push Cam Expando housing **B** into the hole of the Horizontal **1**.

b: Turn Horizontal **1** and lower it onto the small locking screws **A**.

c: Tighten the Cams **B** with a Philips screwdriver.

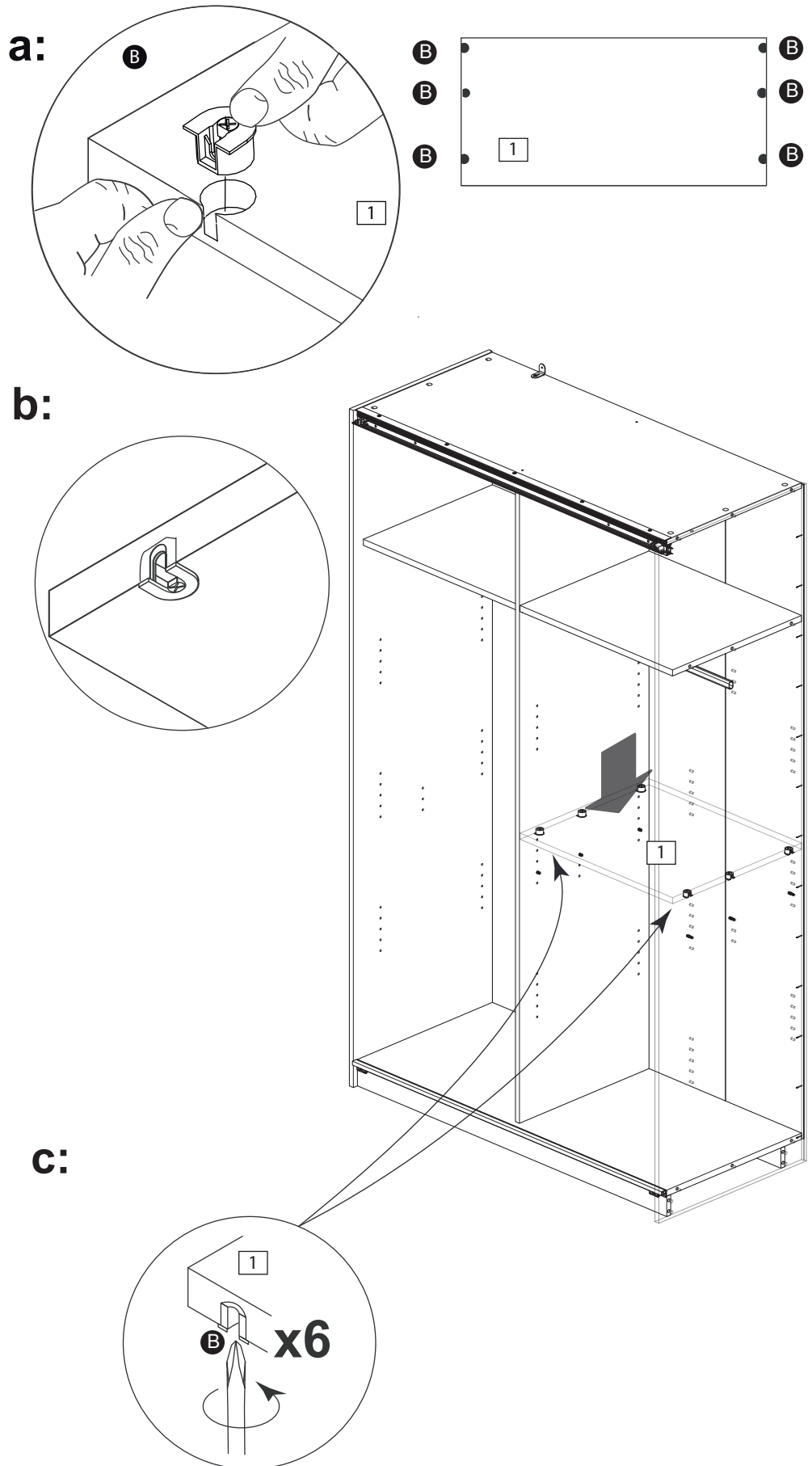

Assembly Instructions

Step 3

inserting shelves

a: Push shelf supports **C** in hole as shown.

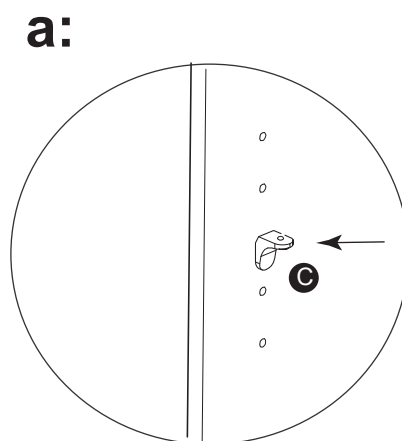

b:

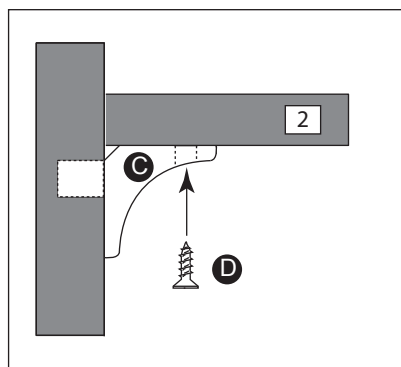

b: Position shelves **2** onto shelf supports **C** and fix by screwing eight chipboardscrews **D** through shelf supports **C** into shelves **2**.

