

Argos

# Bagged Cylinder Vacuum Cleaner

Value Range

Instruction Manual - Please keep for future reference

## VCB32A13S

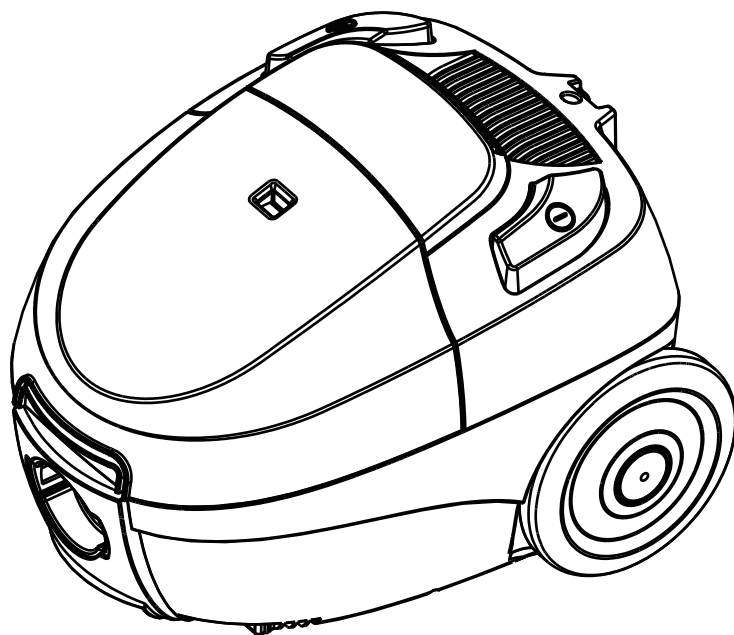

**Important - Please read these instructions fully before installing or using**

These instructions contain important information which will help you get the best from your appliance and ensure safe and correct use and maintenance.

# Contents

<b>Safety Information</b>	<b>2-3</b>
<b>Parts</b>	<b>4</b>
<b>Assembly</b>	<b>5</b>
<b>Operation</b>	<b>6-7</b>
Operating the appliance	6
Using the Cleaning Accessories	7
<b>Maintenance</b>	<b>8-10</b>
Disposable dust bags and filters	8
Replacing the dust bag	8-9
Cleaning and replacing the filters	9-10
Care and Cleaning	10
Storage	10
<b>Troubleshooting</b>	<b>11</b>
<b>Technical Specifications</b>	<b>12</b>
<b>Guarantee</b>	<b>13</b>

# Safety Information

**Important - Please read all instructions before use and keep for future reference**

**FOR HOUSEHOLD USE ONLY.**  
When using the vacuum cleaner, basic safety precautions should always be observed, including the following:

1. Only use the vacuum cleaner indoors on dry surfaces. Do not handle the plug or vacuum cleaner with wet hands. Do not use outdoors or on wet surfaces.
2. Turn off the vacuum cleaner controls before disconnecting or connecting from the mains supply.
3. Always unplug the vacuum cleaner before connecting or disconnecting the vacuum hose and accessories.
4. Children should be supervised to ensure that they do not play with the appliance.
5. This appliance can be used by children aged from 8 years and above and persons with reduced physical, sensory or mental capabilities or lack of experience and knowledge if they have been given supervision or instruction concerning use of the appliance in a safe way and understand the hazards involved.
6. Only use as described in this manual. Only use recommended attachments.
7. Do not use the vacuum cleaner if it has been dropped, damaged, left outdoors or dropped into water.
8. Do not use the vacuum cleaner with a damaged cord or plug. If the supply cord is damaged, please consult qualified technician.
9. Do not pull or carry by cord. Do not use the cord as a handle, close a door on the cord or pull cord around sharp edges or corners. Do not run the vacuum cleaner over the cord. Keep the cord away from heated surfaces.
10. Do not put any objects into openings. Do not use with any openings blocked and do not restrict air-flow. Keep all openings free of dust, lint, hair or anything that might reduce airflow.
11. Keep hair, loose clothing, fingers and all parts of the body away from openings and moving parts.
12. Do not pick up hot coals, cigarette butts, matches or any hot, smoking or burning objects.
13. Do not pick up flammable or combustible materials (lighter fluid, petrol, kerosene etc.) or use in the presence of explosive liquids or vapours.

# Safety Information

**Important - Please read all instructions before use and keep for future reference**

14. Do not vacuum up harmful or toxic material (chlorine, bleach, ammonia, drain cleaner etc.).
15. Do not vacuum up hard or sharp objects such as glass, nails, screws, coins, etc.
- 16 Do not use without ALL of the filters in place.
17. Take extra care when vacuuming on stairs.
18. Keep vacuuming area well lit.
19. Store the vacuum cleaner in a cool, dry area.
20. Turn off the on/off switch before unplugging the vacuum cleaner.
21. Only use CE-approved 13 amp extension cords. Non-approved cords may overheat. Care should be taken to arrange the cord so that the cord cannot be tripped over.

 **WARNING:** Always switch off and unplug the vacuum cleaner from the electrical outlet before assembling, opening or emptying the dirt container, connecting/disconnecting the attachments, or carrying out maintenance or troubleshooting checks.

 **CAUTION:** The vacuum cleaner is a very powerful unit. Before plugging the cord into the electrical outlet, make sure the switch is in the 'off' position. Hold the vacuum cleaner firmly when starting and in use.

 **IMPORTANT:** If the inlet, hose or extension tube is blocked, switch off the vacuum cleaner and remove the blockage(s) before re-starting the vacuum cleaner.

 **IMPORTANT:** We recommend that filters should be checked and cleaned periodically. For washable filters, ensure they are completely dry before inserting back into the vacuum cleaner. Do not wash with detergents. Only use warm water, max 40°C.

 **IMPORTANT:** The motor is equipped with a thermal cut-out. If for any reason the unit should overheat, the thermostat will automatically turn the unit off. Should this occur, unplug the vacuum cleaner from the electrical outlet and turn off the switch. Remove dirt container and empty. Clean filters. Allow the unit to cool for approximately one (1) hour. To re-start, plug into an electrical outlet and switch back on. This vacuum cleaner is intended for household use only and NOT for commercial or industrial use.

**PLEASE KEEP INSTRUCTIONS FOR FURTHER USE**

# Parts

Please familiarise yourself with parts and accessories listed below

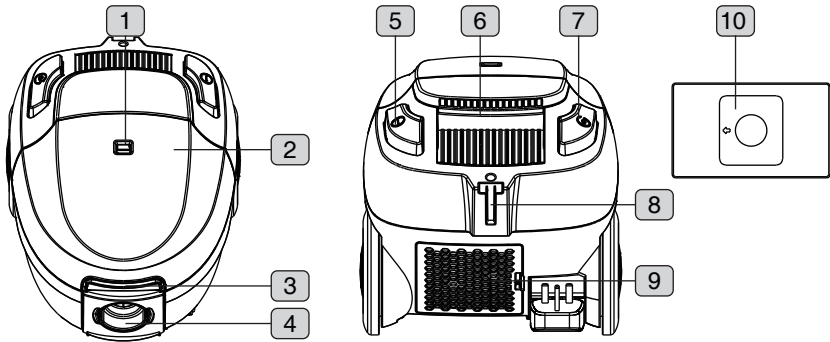

1 Bag full indicator

2 Cover

3 Cover release

4 Hose Inlet

5 ON/OFF pedal

6 Carry handle

7 Cord rewind pedal

8 Storage slot

9 Air outlet filter cover

10 Spare dust bag

## Tools required for assembly

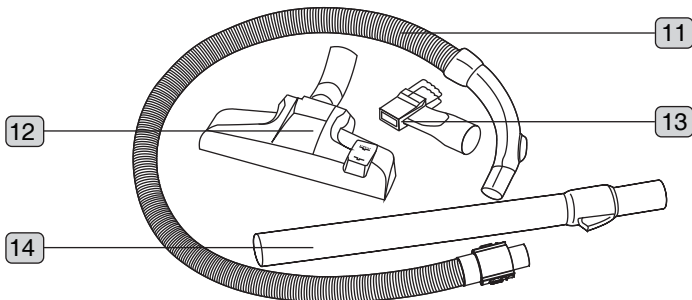

11 Hose and handle

12 Combination floor head

13 Crevice tool

14 Telescopic metal tube

# Assembly

## Hose

Press the tabs on the collar.  
Insert the hose collar in the hose inlet, push it firmly in and release the tabs to lock the collar.  
To remove the collar: Press the tabs on the collar in and then pull the collar out.

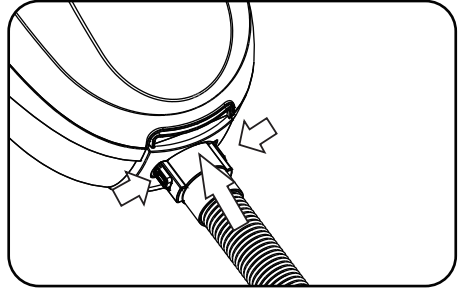

## Connecting tube and accessories

1. Put the handle of the hose into the telescopic tube.

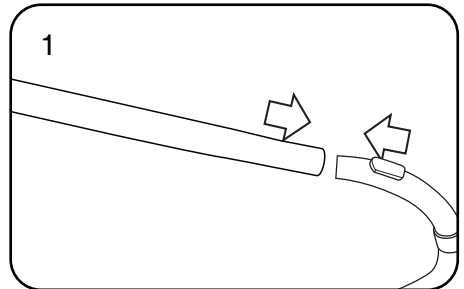

2. Set the telescopic tube to the desired length. To do this ①, push the slide button forward and ② pull out the bottom part of the tube to make it longer. Release the slide button and let the tube snap into place.

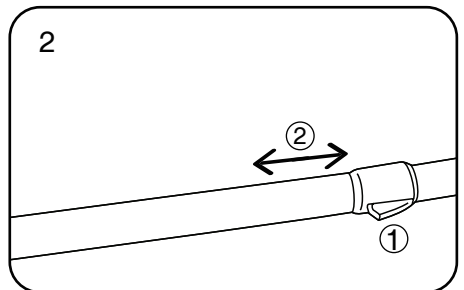

3. Attach the floor nozzle to the telescopic tube by firmly sliding the tube into the nozzle.

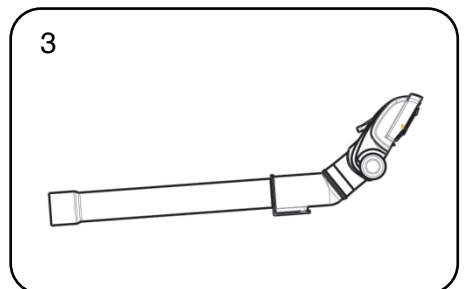

Always remove the plug from the mains socket before assembling or disassembling accessories.

# Operation

## Operating the appliance

**1.** Pull the power cord out of the appliance and insert the mains plug into the mains socket.

A **YELLOW** mark on the power cord indicates the ideal cable length. Do not extend the power cord beyond the **RED** mark.

**Warning:** To avoid over heating always extend to ideal cable length **BEFORE** use.

**2.** Press the power button on top of the appliance to switch on the appliance.

**3.** You can quickly reduce the suction power by pushing the air flow regulator on the hose handle. Push it forward, suction power will increase; push it backward, suction power will reduce.

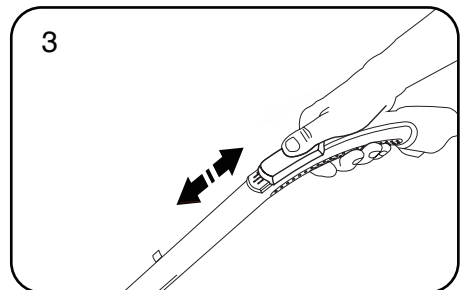
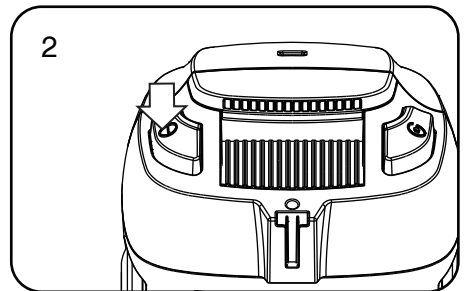
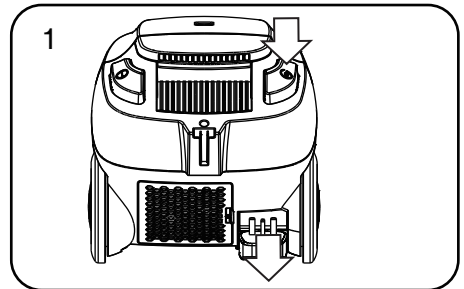

# Operation

## Using the Cleaning Accessories

- Dual position carpet / floor brush

(Drawings for reference only)

Position 1: Bristles extended

- For hard floors 

Position 2: Bristles retracted

- For carpets 

Position 1  
Hard floor

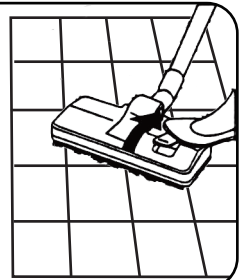

Position 2  
Carpet

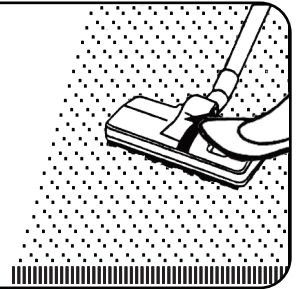

- Combination tool (dusting brush and crevice tool)

For corners, edges or small spaces

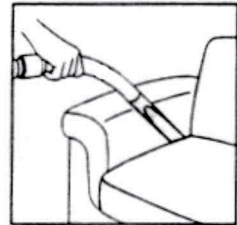



# Maintenance

## Disposable dust bags and filters

The dust bag and the motor filter play a very important roll in the efficiency of the vacuum cleaner. The purpose of the dust bag is to capture dirt, but at the same time the filter needs to be porous enough to allow air to pass through. If the bag or motor filter get clogged, no air can pass through the cleaner and no cleaning can take place regardless of how powerful the unit is.

To keep the cleaner operating at maximum efficiency, change the dust bag frequently and clean the filter when needed. Some fine particles can restrict the air flow very quickly and will decrease the performance even before the bag appears to be full. For that reason, the bag and filter may need to be changed more often when vacuuming carpet fresheners or cleaners, powder, plaster dust or similar fine substances.

When the 'Dust Bag Full' indicator goes red the dust bag must be emptied to avoid damage to the cleaner.

Empty the dust bag at regular intervals to prevent clogging, which carries a risk of loss of suction power and poor cleaning performance.

## Replacing the dust bag

Be sure to turn off and unplug the vacuum cleaner before replacing the dust bag or cleaning the filter. Never vacuum without the dust bag or filter in place.

1. Turn off and unplug the vacuum cleaner.
2. Remove the hose from the hose connection and open the dust bag compartment by pushing the handle upwards and lifting the lid.
3. Slide the dust bag out of the frame and remove the dust bag from the dust bag compartment.

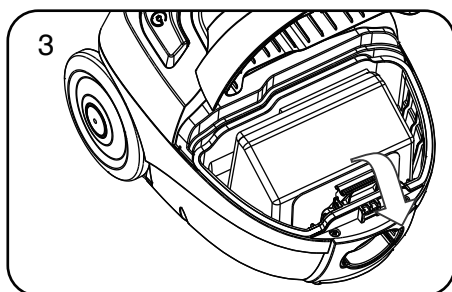
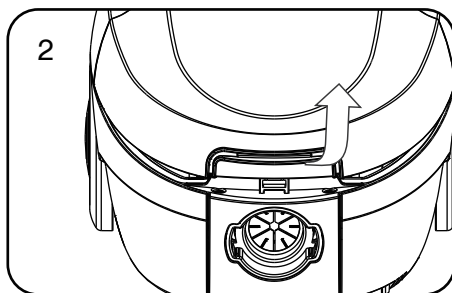

# Maintenance

## Replacing the dust bag

4. Fit a new bag into the cavity. The edge marked with a black arrow fits into a slot in the base of the cavity.

5. Holding the retaining catch bring the top edge of the bag forward then release the catch to secure the bag as shown.

6. Close the lid.

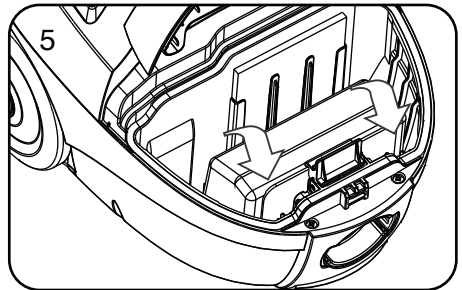
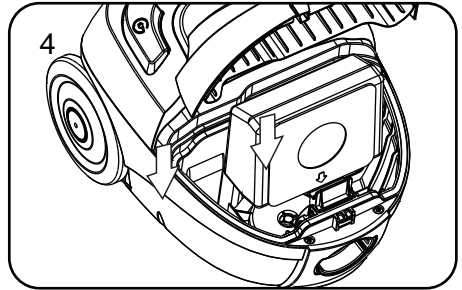

## Cleaning and Replacing the Filters

1. The Inlet Filter is at the rear of the inside compartment. Open the lid and pull the filter out of its cradle.

2. Brush the inlet cavity out. This will help keep the airways clean and maintain performance.

Wash the filter under running water. Allow to dry fully. When the filter is dry, replace the filter.  
**NEVER** replace a filter if it is wet.

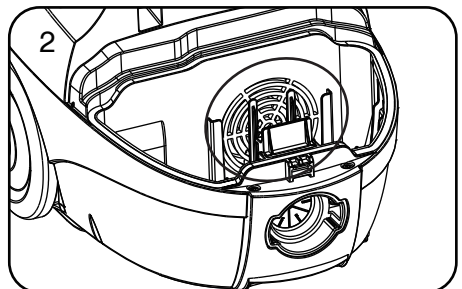
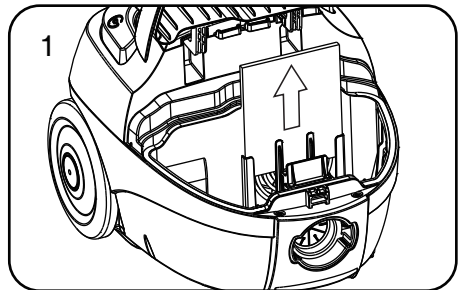

# Maintenance

## Cleaning and Replacing the Filters

3. The Motor Filter is at the rear of the cleaner.

A: Remove the filter cage.

B: Brush out the cavity in the rear of the cleaner. This will maintain the performance of the cleaner.

4. Remove the filter from the cage. Wash the filter under running water. Allow to dry. When it is dry, replace the filter in the cage and then replace the cage. NEVER replace a filter if it is wet.

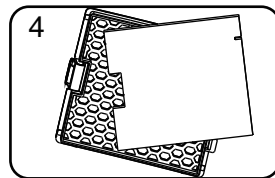
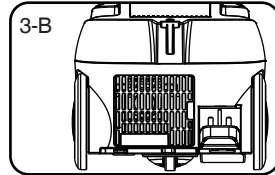
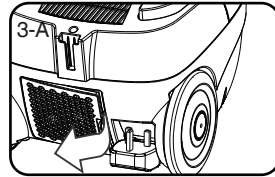

## Care and Cleaning

Switch the cleaner off and unplug from the mains.

Empty the dust bag and clean the filters.

Wipe the cleaner body with a damp cloth and dry thoroughly. Do NOT allow water or liquids to penetrate the vacuum cleaner. This could be dangerous.

Store the cleaner safely out of the reach of children and pets.

## Storage

The cleaner can be stored upright on its base with the hose and accessories disconnected and separately stored. Alternatively, it may be stored in the normal position with the tube and floor brush parked on the hook as shown.

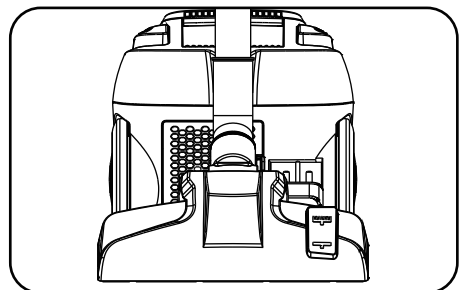

# Troubleshooting

<b>Problem</b>	<b>Possible causes</b>	<b>Solutions</b>
There is an accessory missing	1. A part(s) is missing from box	1. Check the 'PARTS' page of your instructions
The vacuum cleaner does not switch on	<ol style="list-style-type: none"> <li>1. The unit is not plugged into a mains socket</li> <li>2. The power button on the unit has not been depressed</li> <li>3. The thermal motor cut out has been activated</li> <li>4. There is no electricity to the power socket</li> </ol>	<ol style="list-style-type: none"> <li>1. Ensure the plug is firmly in the socket and switched on</li> <li>2. Depress the power switch on the unit</li> <li>3. If the unit has cut out during use, disconnect the unit from the wall socket, allow to cool for one hour, clean the filters, empty bin and check the hose/accessories for blockages</li> <li>4. Seek expert help from a qualified electrician</li> </ol>
The vacuum cleaner won't pick up	<ol style="list-style-type: none"> <li>1. The accessories are not correctly fitted</li> <li>2. There are blockages in the hose/accessory</li> <li>3. The dust bag is full</li> <li>4. The filters are blocked/clogged</li> </ol>	<ol style="list-style-type: none"> <li>1. Check hose/tools are correctly attached to the machine/hose/tube; refer to 'ASSEMBLY/ OPERATION' section</li> <li>2. Check the air paths of the hose/accessory are not obstructed by blockages</li> <li>3. Check dust bag and if necessary empty</li> <li>4. Frequently cleaning filters will maintain performance; see 'MAINTENANCE' section</li> </ol>
Dust is escaping from the vacuum cleaner	<ol style="list-style-type: none"> <li>1. The filters/dust bag are not fitted correctly</li> <li>2. The filters are damaged</li> </ol>	<ol style="list-style-type: none"> <li>1. See 'PARTS' and 'MAINTENANCE' sections</li> <li>2. If the filters are damaged these will need to be replaced</li> </ol>
Accessories won't pick up dust/debris	<ol style="list-style-type: none"> <li>1. The wrong tool is fitted for the task</li> <li>2. The tools are blocked</li> <li>3. The filters are blocked</li> <li>4. The dust bag is full</li> <li>5. The hose/tubes are blocked</li> </ol>	<ol style="list-style-type: none"> <li>1. See 'PARTS' section</li> <li>2. Check the air paths of the tools are not obstructed by blockages</li> <li>3. Frequently cleaning filters will maintain performance; check 'MAINTENANCE' section</li> <li>4. Check and empty the dust bag</li> <li>5. Check the air paths of the hose/tubes are not obstructed by blockages</li> </ol>
The blockage indicator (if applicable to model) activates	<ol style="list-style-type: none"> <li>1. The filters/dust bag are blocked</li> <li>2. The dust bag is full</li> <li>3. The accessories/hose/tube are blocked</li> </ol>	<ol style="list-style-type: none"> <li>1. Frequently cleaning filters will maintain performance; check 'MAINTENANCE' section</li> <li>2. Check and empty dust bag</li> <li>3. Check the air paths of the accessories/hose/tubes are not obstructed by blockages</li> </ol>

# Technical Specifications

<b>Model Number</b>	VCB32A13S
Voltage	220-240V~ 50HZ
Energy efficiency class	C
Annual energy consumption	37,8 kWh/annum
Carpet cleaning performance class	E
Hard floor cleaning performance class	B
Dust re-emission class	G
Sound power level	89dB(A)
Rated input power	1000W

We apologise for any inconvenience caused by minor inconsistencies in these instructions, which may occur as a result of product improvements and development.



## EEC statement of compliance



Manufacturer/EEC importer: Hereby on our own responsibility, declare that the VCB32A13S is manufactured in compliance with the following Directives:

Safety: 2006/95/EC Low Voltage Directive  
EMC: 2004/108/EC Electromagnetic Compatibility Directive

Waste electrical products should not be disposed of with household waste. Please recycle where facilities exist. Check with your Local Authority or retailer for recycling advice.



## PRODUCT GUARANTEE

This product is guaranteed against manufacturing defects for a period of



Year

This product is guaranteed for twelve months from the date of original purchase.

Any defect that arises due to faulty materials or workmanship will either be replaced, refunded or repaired free of charge where possible during this period by the dealer from whom you purchased the unit.

The guarantee is subject to the following provisions:

- The guarantee does not cover accidental damage, misuse, cabinet parts, knobs or consumable items.
- The product must be correctly installed and operated in accordance with the instructions contained in this manual.
- It must be used solely for domestic purpose.
- The guarantee will be rendered invalidated if the product is re-sold or has been damaged by inexpert repair.
- Specifications are subject to change without notice.
- The manufacturer disclaims any liability for the incidental or consequential damages.
- The guarantee is in addition to, and does not diminish your statutory or legal rights.
- In the event of a problem with the product within the guarantee period call the Customer Helpline on 0345 640 0800.

Guarantor: Argos Ltd  
489 - 499 Avebury Boulevard  
Central Milton Keynes  
MK9 2NW