

Houston chair

Assembly Instructions - Please keep for future reference

429/1437

436/7691

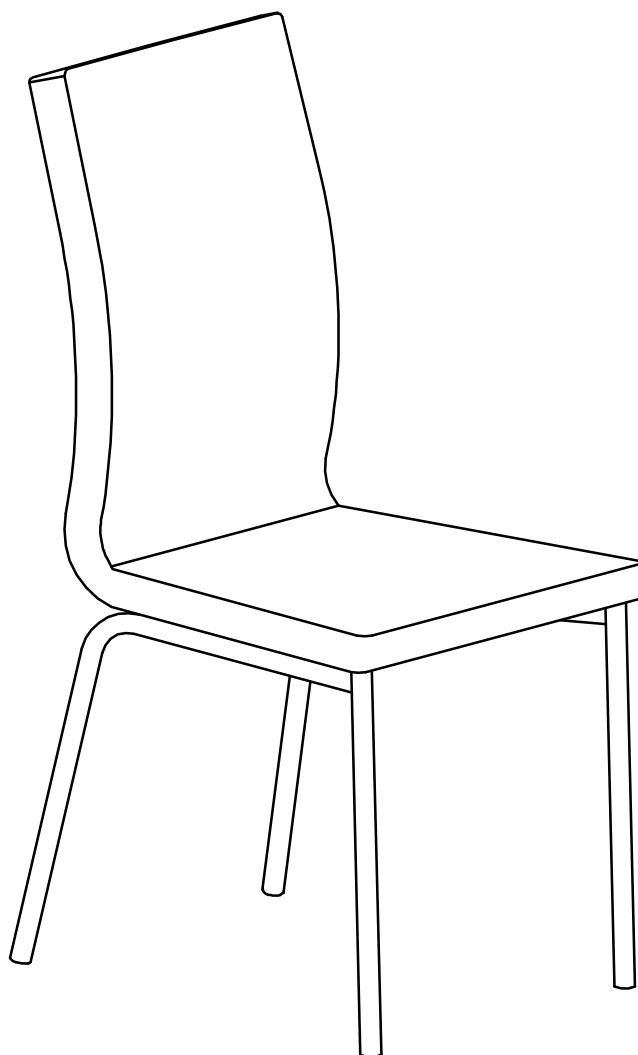

Dimensions

Width - 44cm
Depth - 53.5cm
Height - 97.7cm

Important – Please read these instructions fully before starting assembly

If you need help or have damaged or missing parts, call the **Customer Helpline:**
Argos = 0345 6400800



Safety and Care Advice

Important – Please read these instructions fully before starting assembly

- Check you have all the components and tools listed on the following pages.
- Remove all fittings from the plastic bags and separate them into their groups.
- Keep children and animals away from the work area, small parts could choke if swallowed.
- Make sure you have enough space to layout the parts before starting.

- During assembly do not stand or put weight on the product, this could cause damage.
- Assemble the item as close to its final position (in the same room) as possible.
- Assemble on a soft level surface to avoid damaging the unit or your floor.
- Parts of the assembly will be easier with 2 people.



- To reduce the likelihood of damaging your product please ensure that your power drill is set on a low torque setting.
- Do not stand on the chair.
- Do not use this chair as a step ladder.
- Maximum safe weight of user: 110kgs.

Care and maintenance

- Only clean using a damp cloth and mild detergent, do not use bleach or abrasive cleaners.
- From time to time check that there are no loose screws on this unit.
- This product should not be discarded with household waste. Take to your local authority waste disposal centre.

Handy Hints

- Assemble all parts and bolts loosely during assembly, only once the product is complete should you fully tighten the bolts
- Regularly check and ensure that all bolts and fittings are tightened properly.

Components - Panels

If you have damaged or missing components, call the
Customer Helpline: Argos = 0345 6400800

Please check you have all the panels listed below

The quantities below are for 2 chairs

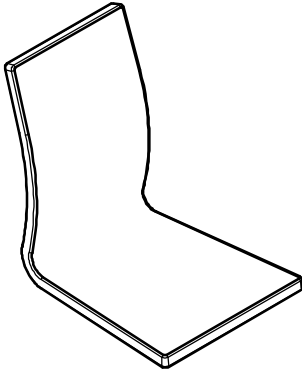

1 Chair seat x 2

(44 x 53.5 x 56.5 cm)

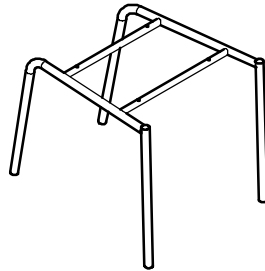





2 Leg frame x 2

(43 x 53 x 42 cm)

Components - Fittings

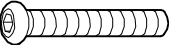
Please check you have all the fittings listed below

Note: The quantities below are the correct amount to complete the assembly of 2 chairs. In some cases more fittings may be supplied than are required.

<p>A </p> <p>38mm Bolt x 8</p>	<p>B </p> <p>Spring washer x 8</p>	<p>C </p> <p>Plain washer x 8</p>
<p>D </p> <p>Hex key x 1</p>		

Ruler - Use this ruler to help correctly identify the screws

0 5 10 15 20 25 30 35 40 45 50 55 60 65 70 75 80 85 90 95 100 105 110 115 120 125 130 135 140 145 150 155 160 165 170

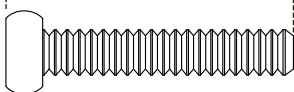

The bolts length is measured from the head to the point (38mm bolt shown).

Assembly Instructions

Step 1

Fix chair seat **1** and leg frame **2** by using bolts **A**, spring washers **B** and plain washers **C**.

Turn the chair upright
Assembly is complete.

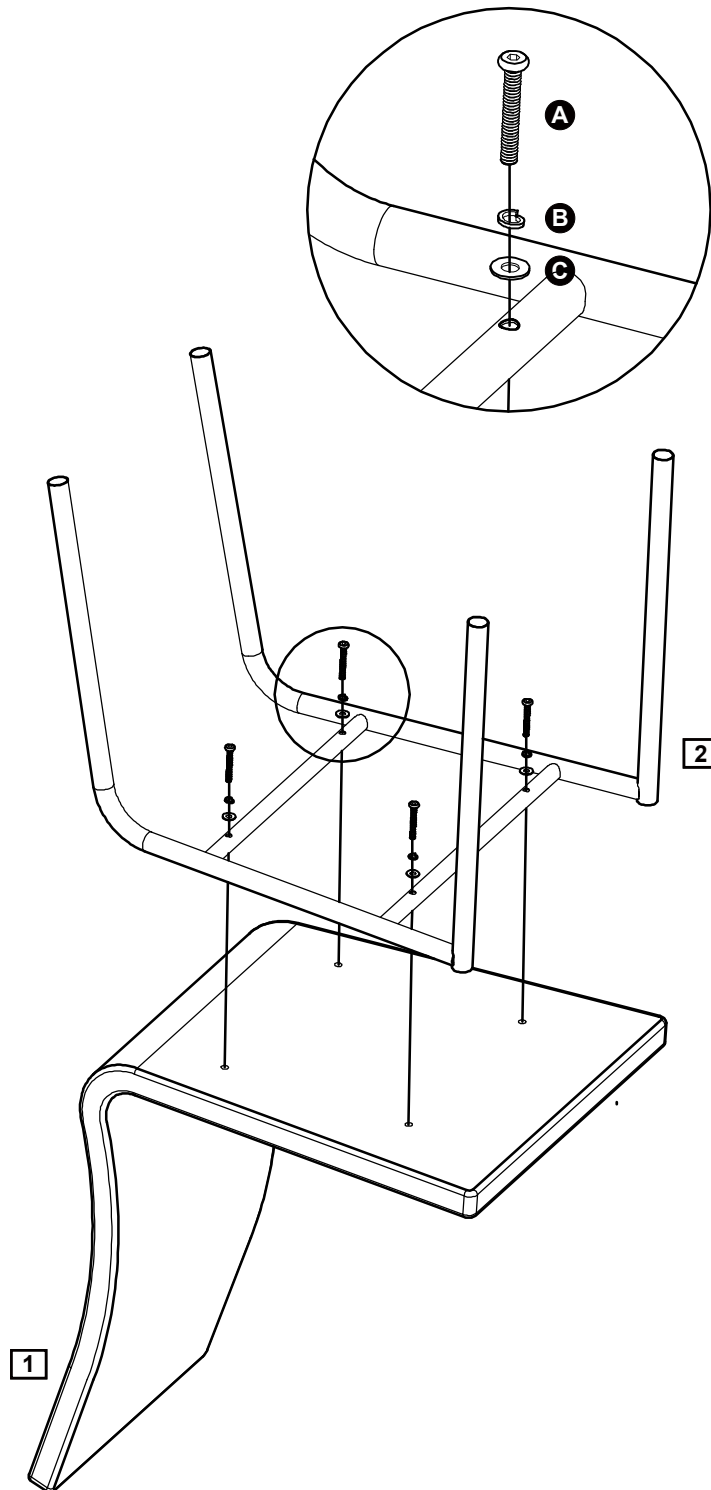

If you need help or have damaged or missing parts, call the **Customer Helpline:**
Argos = 0345 640800