

# Lexie Chair

Assembly Instructions - Please keep for future reference

427/7396

409/9407

412/3316

402/8947

**hygena**

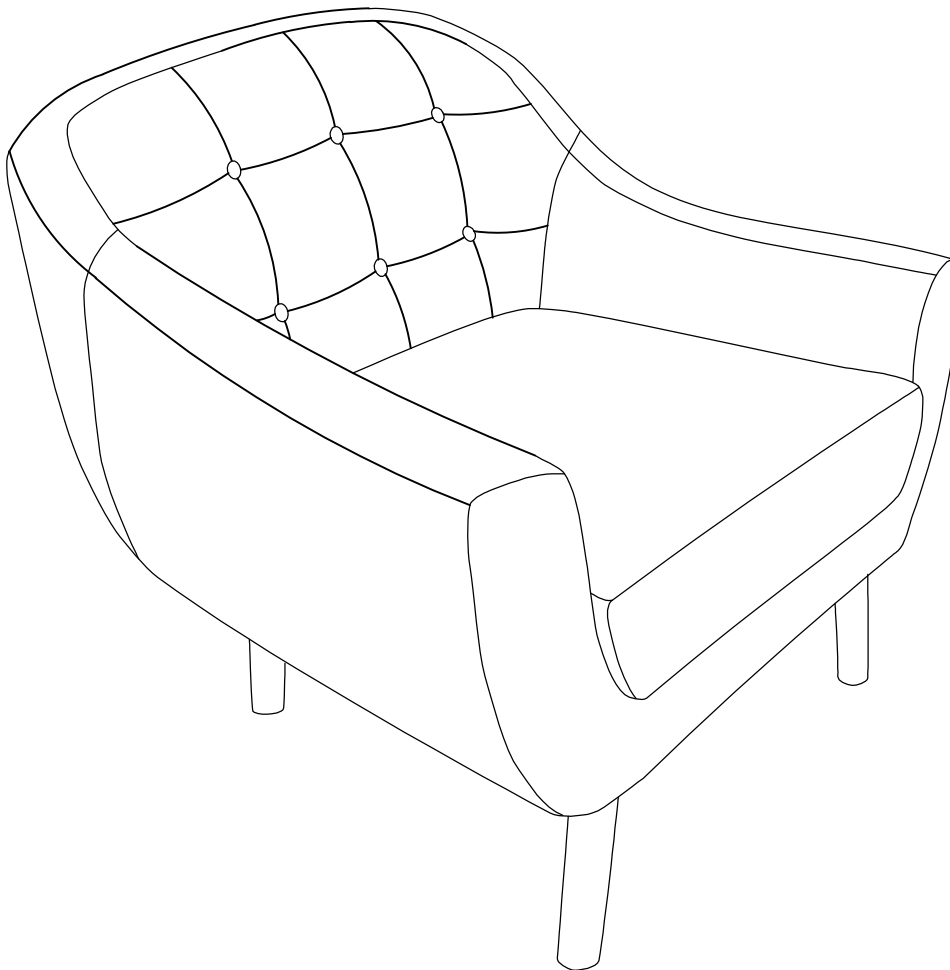

## Dimensions

Depth - 82cm  
Width - 81cm  
Height - 86cm

**Important - Please read these instructions fully before starting assembly**

If you need help or have damaged or missing parts, call the **Customer Helpline: 0345 6400 800**



## Safety and Care Advice

**Important - Please read these instructions fully before starting assembly**

Check you have all the components and tools listed on pages 2.

Remove all fittings from the plastic bags and separate them into their groups.

Keep children and animals away from the work area, small parts could choke if swallowed.

Make sure you have enough space to layout the parts before starting.

Assemble the item as close to its final position (in the same room) as possible.

Assemble on a soft level surface to avoid damaging the unit or your floor.

Assembly requires 2 people.



We do not recommend the use of power drill/drivers **for inserting screws**, as this could damage the unit. Only use hand screwdrivers and Allen keys.

Dispose of all packaging carefully and responsibly.

### Cleaning Guidance

Minor stains and spillages should be removed immediately from cushion fabric, by wiping over lightly with a damp cloth and mild soapy water.

Light marking can also be removed using this method.

To remove more stubborn stains or marking, a good quality proprietary domestic fabric cleaner can be used, although it should first be tested on an inconspicuous area of the fabric.

### Care and maintenance

From time to time check that there are no loose screws on this unit.

This product should not be discarded with household waste. Take to your local authority waste disposal centre.

# Components - Parts

If you have damaged or missing components.  
call the **Customer Helpline**: 0345 6400 800

Please check you have all the parts listed below

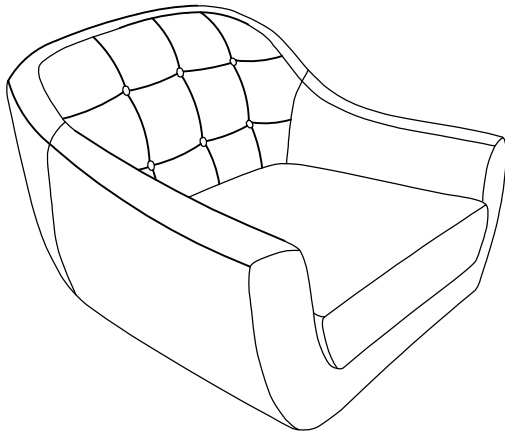

**1** Seat  
(83 x 82 x 65cm)



**2** Front leg x 2  
(50 x 50 x 275cm)



**3** Back leg (right)  
(50 x 50 x 275cm)



**4** Back leg (left)  
(50 x 50 x 275cm)





**Note:** Legs **2**, **3** and **4** are located inside the zipped lining on the underside of seat **1**.

# Components - Fittings

If you have damaged or missing components, call the **Customer Helpline: 0345 6400 800**

Please check you have all the fittings listed below

**Note:** The quantities below are the correct amount to complete the assembly. In some cases more fittings may be supplied than are required.

<b>A</b>  M8x50mm screw x 8	<b>B</b>  Plain washer x 8	<b>C</b>  Spring washer x 8
<b>D</b>  Allen key x 1		

## Tools required

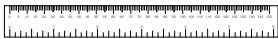

Ruler/tape  
measure

## Ruler - Use this ruler to help correctly identify the screws

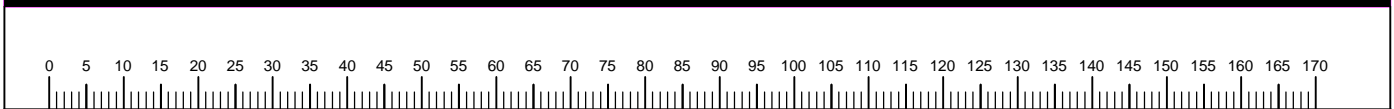

# Assembly Instructions

## Step 1

### Locating legs

With help, carefully turn seat **1** onto its back on a clean flat surface.

**Warning:** The seat is heavy. Lift with care.

Unzip the fabric lining on the underside, to locate a separate package containing the legs **2**, **3** and **4**.

Do not close the zip as access is still required inside, for the following leg assembly.

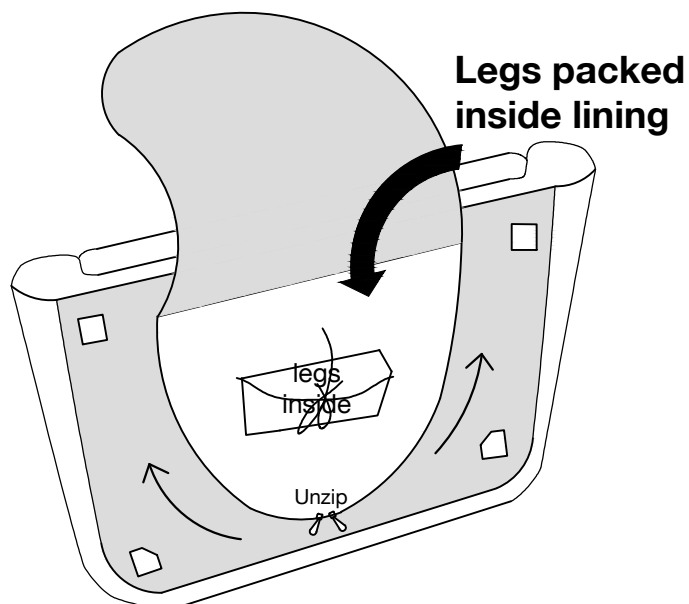

## Step 2

### Attaching legs

**a:** Assemble front legs **2** at the front of seat **1** using fixings **A**, **B** and **C**.

**b:** Carefully locate back legs **3** and **4** to the correct sides (left/ right) of seat **1** as shown. Secure using fixings **A**, **B** and **C**.

**Note:** Legs **2**, **3** and **4** have been labelled for easier identification.

Once all legs are fitted, re-zip the fabric lining closed.

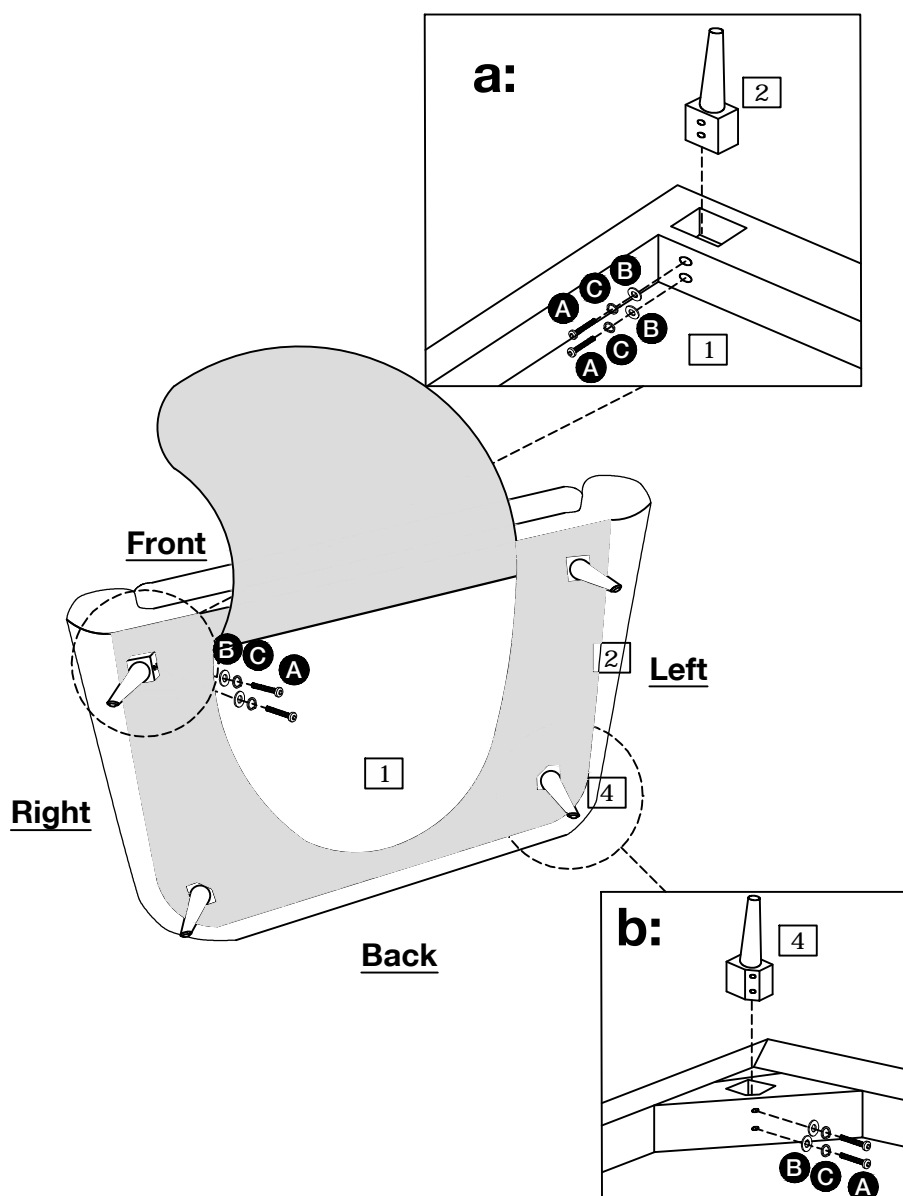

# Assembly Instructions

## Step 3

With help, carefully stand the chair upright.

**⚠ Warning:** The chair is heavy. Lift with care.

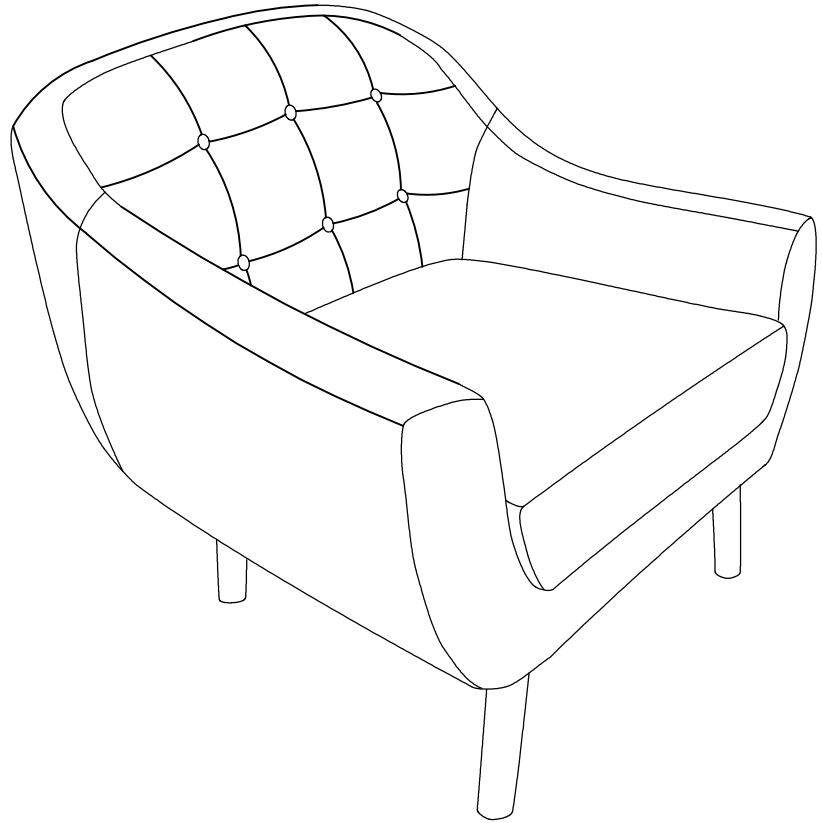

**Assembly is complete.**

If you need help or have damaged or missing parts, call the **Customer Helpline: 0345 6400 800**  
Home Retail Group, 489-499 Avebury Boulevard, Saxon Gate West, Central Milton Keynes, MK9 2NW