

Canon

PowerShot SX410 IS *PowerShot SX412 IS* Camera User Guide

ENGLISH

Before Use

Basic Guide

Advanced Guide

1 Camera Basics

2 Auto Mode

3 Other Shooting Modes

4 P Mode

5 Playback Mode

6 Setting Menu

7 Accessories

8 Appendix

Index

- Make sure you read this guide, including the “Safety Precautions” (11) section, before using the camera.
- Reading this guide will help you learn to use the camera properly.
- Store this guide safely so that you can use it in the future.

- Click the buttons in the lower right to access other pages.

 : Next page

 : Previous page

 : Page before you clicked a link

- To jump to the beginning of a chapter, click the chapter title at right.

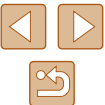

Before Use

Initial Information

Package Contents

Before use, make sure the following items are included in the package. If anything is missing, contact your camera retailer.



Camera



Battery Pack
NB-11LH*



Battery Charger
CB-2LF/CB-2LFE



Wrist Strap



Lens Cap
(with cord)

* Do not peel off the battery pack label.

- Printed matter is also included.
- A memory card is not included (📖2).

Compatible Memory Cards

The following memory cards (sold separately) can be used, regardless of capacity.

- SD memory cards*
- SDHC memory cards*
- SDXC memory cards*



- Eye-Fi cards

* Cards conforming to SD standards. However, not all memory cards have been verified to work with the camera.

About Eye-Fi Cards

This product is not guaranteed to support Eye-Fi card functions (including wireless transfer). In case of an issue with an Eye-Fi card, please check with the card manufacturer.

Also note that an approval is required to use Eye-Fi cards in many countries or regions. Without approval, use of the card is not permitted. If it is unclear whether the card has been approved for use in the area, please check with the card manufacturer.

Before Use

Basic Guide

Advanced Guide

1 Camera Basics

2 Auto Mode

3 Other Shooting Modes

4 P Mode

5 Playback Mode

6 Setting Menu

7 Accessories

8 Appendix

Index



Preliminary Notes and Legal Information

- Take and review some test shots initially to make sure the images were recorded correctly. Please note that Canon Inc., its subsidiaries and affiliates, and its distributors are not liable for any consequential damages arising from any malfunction of a camera or accessory, including memory cards, that result in the failure of an image to be recorded or to be recorded in a way that is machine readable.
- Images recorded by the camera shall be for personal use. Refrain from unauthorized recording that infringes on copyright law, and note that even for personal use, photography may contravene copyright or other legal rights at some performances or exhibitions, or in some commercial settings.
- For information on camera warranty or Canon Customer Support, please refer to the warranty information provided with your camera User Manual Kit.
- Although the LCD monitor is produced under extremely high-precision manufacturing conditions and more than 99.99% of the pixels meet design specifications, in rare cases some pixels may be defective or may appear as red or black dots. This does not indicate camera damage or affect recorded images.
- The LCD monitor may be covered with a thin plastic film for protection against scratches during shipment. If covered, remove the film before using the camera.
- When the camera is used over an extended period, it may become warm. This does not indicate damage.

Part Names and Conventions in This Guide

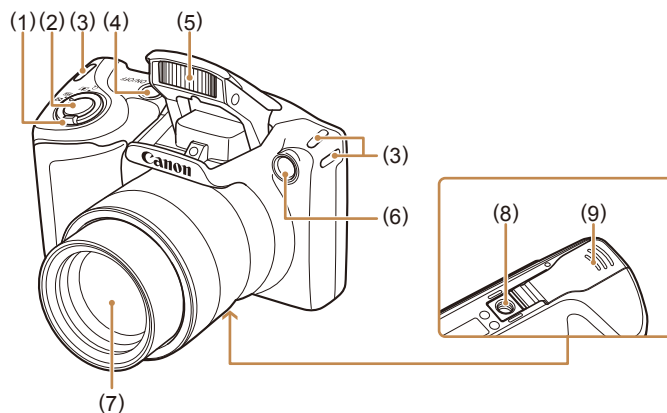

- | | |
|---|-------------------------------|
| (1) Zoom lever
Shooting: [▲] (telephoto) /
[■] (wide angle)
Playback: [Q] (magnify) /
[■] (index) | (4) ON/OFF button |
| (2) Shutter button | (5) Flash |
| (3) Strap mount | (6) Lamp |
| | (7) Lens |
| | (8) Tripod socket |
| | (9) Memory card/battery cover |

Before Use

Basic Guide

Advanced Guide

1 Camera Basics

2 Auto Mode

3 Other Shooting Modes

4 P Mode

5 Playback Mode

6 Setting Menu

7 Accessories

8 Appendix

Index



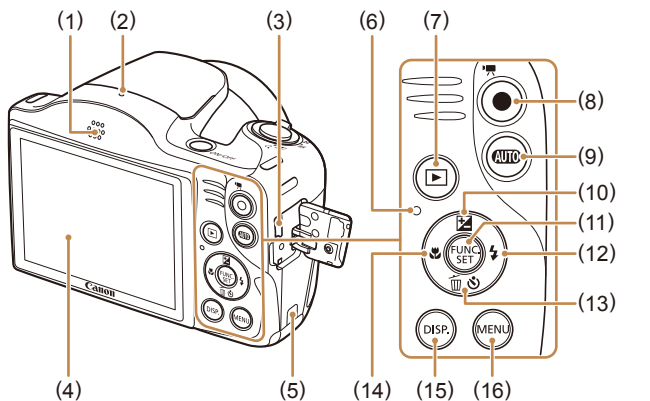

- | | |
|--|--|
| (1) Speaker | (10) (Exposure compensation) / Up button |
| (2) Microphone | (11) FUNC./SET button |
| (3) AV OUT (Audio/video output) / DIGITAL terminal | (12) (Flash) / Right button |
| (4) Screen (LCD monitor) | (13) (Self-timer) / (Single-image erase) / Down button |
| (5) DC coupler cable port | (14) (Focusing range) / Left button |
| (6) Indicator | (15) DISP. (Display) button |
| (7) (Playback) button | (16) MENU button |
| (8) Movie button | |
| (9) AUTO (Auto) button | |

- In this guide, icons are used to represent the corresponding camera buttons on which they appear, or which they resemble.
- The following camera buttons and controls are represented by icons.
 - Up button (10) on back
 - Left button (14) on back
 - Right button (12) on back
 - Down button (13) on back

- Shooting modes and on-screen icons and text are indicated in brackets.
- : Important information you should know
- : Notes and tips for expert camera use
- xx: Pages with related information (in this example, “xx” represents a page number)
- Instructions in this guide apply to the camera under default settings.
- For convenience, all supported memory cards are simply referred to as the “memory card”.
- The symbols “▶ **Still Images**” and “▶ **Movies**” below titles indicate how the function is used—whether for still images or movies.

Before Use
Basic Guide
Advanced Guide
1 Camera Basics
2 Auto Mode
3 Other Shooting Modes
4 P Mode
5 Playback Mode
6 Setting Menu
7 Accessories
8 Appendix
Index



Table of Contents

Before Use

Initial Information	2
Package Contents	2
Compatible Memory Cards.....	2
About Eye-Fi Cards	2
Preliminary Notes and Legal Information	3
Part Names and Conventions in This Guide	3
Common Camera Operations	10
Safety Precautions	11

Basic Guide

Basic Operations	14
Initial Preparations.....	14
Attaching Accessories	14
Holding the Camera.....	15
Charging the Battery Pack.....	15
Inserting the Battery Pack and Memory Card.....	16
Removing the Battery Pack and Memory Card	16
Setting the Date and Time	17
Changing the Date and Time.....	17
Display Language.....	18
Trying the Camera Out.....	19
Shooting (Smart Auto).....	19
Viewing	20
Erasing Images	21

Advanced Guide

1 Camera Basics	22
On/Off.....	22
Power-Saving Features (Auto Power Down).....	23
Power Saving in Shooting Mode	23
Power Saving in Playback Mode.....	23
Shutter Button	23
Shooting Display Options	24
Using the FUNC. Menu	24
Using the Menu Screen.....	25
Indicator Display.....	26
Clock	27
2 Auto Mode	28
Shooting with Camera-Determined Settings	28
Shooting (Smart Auto)	28
Still Images/Movies	30
Still Images.....	30
Movies	30
Scene Icons.....	31
Image Stabilization Icons.....	32
On-Screen Frames.....	32
Common, Convenient Features	33
Zooming In Closer on Subjects (Digital Zoom).....	33
Using the Self-Timer	33
Using the Self-Timer to Avoid Camera Shake	34
Customizing the Self-Timer	34
Adding a Date Stamp	35
Continuous Shooting	35
Image Customization Features	36
Changing the Aspect Ratio.....	36

Before Use
Basic Guide
Advanced Guide
1 Camera Basics
2 Auto Mode
3 Other Shooting Modes
4 P Mode
5 Playback Mode
6 Setting Menu
7 Accessories
8 Appendix
Index



Changing Image Resolution (Size).....	37
Guidelines for Choosing Resolution Based on Paper Size (for 4:3 Images).....	37
Changing Movie Image Quality	37
Helpful Shooting Features.....	38
Displaying Grid Lines.....	38
Magnifying the Area in Focus	38
Checking for Closed Eyes	39
Customizing Camera Operation	39
Deactivating the AF-Assist Beam	39
Deactivating the Red-Eye Reduction Lamp.....	40
Changing the Image Display Style after Shots	40
Changing the Image Display Period after Shots	40
Changing the Screen Displayed after Shots	40
3 Other Shooting Modes	42
Brightness / Color Customization (Live View Control).....	42
Specific Scenes.....	43
Applying Special Effects.....	44
Shooting with a Fish-Eye Lens Effect (Fish-Eye Effect)	44
Shots Resembling Miniature Models (Miniature Effect).....	45
Playback Speed and Estimated Playback Time (for One-Minute Clips)	45
Shooting with a Toy Camera Effect (Toy Camera Effect).....	46
Shooting in Monochrome.....	46
Special Modes for Other Purposes	47
Using the Face Self-Timer	47
Shooting Long Exposures (Long Shutter)	47
4 P Mode.....	49
Shooting in Program AE ([P] Mode).....	49
Image Brightness (Exposure).....	50
Adjusting Image Brightness (Exposure Compensation).....	50

Locking Image Brightness / Exposure (AE Lock)	50
Changing the Metering Method	51
Changing the ISO Speed.....	51
Correcting Image Brightness (i-Contrast)	52
Image Colors	52
Adjusting White Balance.....	52
Custom White Balance.....	53
Changing Image Color Tones (My Colors)	53
Custom Color.....	54
Shooting Range and Focusing	54
Shooting Close-Ups (Macro)	54
Shooting Distant Subjects (Infinity).....	55
Digital Tele-Converter	55
Changing the AF Frame Mode	55
Center.....	55
Face AiAF	56
Choosing Subjects to Focus On (Tracking AF)	56
Shooting with Servo AF	57
Changing the Focus Setting	57
Shooting with the AF Lock	58
Flash.....	58
Changing the Flash Mode	58
Auto	58
On.....	58
Slow Synchro	58
Off.....	59
Shooting with the FE Lock.....	59
Other Settings	59
Changing the Compression Ratio (Image Quality).....	59
Changing the IS Mode Settings.....	60
Shooting Movies with Subjects at the Same Size Shown before Shooting	60

Before Use
Basic Guide
Advanced Guide
1 Camera Basics
2 Auto Mode
3 Other Shooting Modes
4 P Mode
5 Playback Mode
6 Setting Menu
7 Accessories
8 Appendix
Index



5 Playback Mode	61
Viewing.....	61
Switching Display Modes.....	62
Overexposure Warning (for Image Highlights)	62
Histogram	63
Browsing and Filtering Images.....	63
Navigating through Images in an Index.....	63
Finding Images Matching Specified Conditions.....	64
Image Viewing Options	65
Magnifying Images	65
Viewing Slideshows.....	65
Changing Slideshow Settings.....	66
Auto Playback of Related Images (Smart Shuffle).....	66
Protecting Images	67
Using the Menu	67
Choosing Images Individually.....	67
Selecting a Range	68
Protecting All Images at Once	69
Clearing All Protection at Once	69
Erasing Images	69
Erasing Multiple Images at Once.....	69
Choosing a Selection Method	69
Choosing Images Individually.....	70
Selecting a Range	70
Specifying All Images at Once.....	70
Rotating Images	71
Using the Menu	71
Deactivating Auto Rotation	71
Tagging Images as Favorites	72
Using the Menu	72
Editing Still Images.....	73

Resizing Images.....	73
Cropping.....	73
Changing Image Color Tones (My Colors)	74
Correcting Image Brightness (i-Contrast).....	75
Correcting Red-Eye.....	75
Editing Movies.....	76
6 Setting Menu.....	77
Adjusting Basic Camera Functions	77
Silencing Camera Operations.....	77
Adjusting the Volume.....	77
Hiding Hints and Tips.....	78
Date and Time	78
World Clock	78
Lens Retraction Timing.....	79
Using Eco Mode	79
Power-Saving Adjustment	79
Screen Brightness	80
Hiding the Start-Up Screen.....	80
Formatting Memory Cards.....	80
Low-Level Formatting	81
File Numbering	81
Date-Based Image Storage	82
Checking Certification Logos.....	82
Display Language.....	82
Adjusting Other Settings.....	82
Restoring Defaults	83
7 Accessories	84
System Map	84
Optional Accessories.....	85
Power Supplies.....	85
Flash Unit	86

Before Use
Basic Guide
Advanced Guide
1 Camera Basics
2 Auto Mode
3 Other Shooting Modes
4 P Mode
5 Playback Mode
6 Setting Menu
7 Accessories
8 Appendix
Index

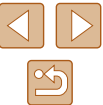

Other Accessories	86
Printer	86
Using Optional Accessories.....	87
Playback on a TV	87
Powering the Camera with Household Power	87
Using the Software	89
Checking Your Computer Environment	89
Installing the Software	89
Saving Images to a Computer	90
Printing Images	91
Easy Print	91
Configuring Print Settings.....	92
Cropping Images before Printing.....	93
Choosing Paper Size and Layout before Printing	93
Available Layout Options.....	94
Printing ID Photos	94
Printing Movie Scenes.....	94
Movie Printing Options	95
Adding Images to the Print List (DPOF)	95
Configuring Print Settings.....	95
Setting Up Printing for Individual Images	96
Setting Up Printing for a Range of Images.....	96
Setting Up Printing for All Images.....	96
Clearing All Images from the Print List	96
Printing Images Added to the Print List (DPOF).....	97
Adding Images to a Photobook	97
Choosing a Selection Method	97
Adding Images Individually.....	97
Adding All Images to a Photobook	98
Removing All Images from a Photobook	98
Using an Eye-Fi Card	98
Checking Connection Information	99

Disabling Eye-Fi Transfer	99
8 Appendix	100
Troubleshooting.....	100
On-Screen Messages.....	103
On-Screen Information.....	104
Shooting (Information Display)	104
Battery Level	105
Playback (Detailed Information Display).....	105
Summary of Movie Control Panel.....	106
Functions and Menu Tables	106
Functions Available in Each Shooting Mode	106
FUNC. Menu.....	107
Shooting Tab.....	109
Set Up Tab.....	111
Playback Tab	111
Print Tab	112
Playback Mode FUNC. Menu	112
Handling Precautions	112
Specifications	113
Camera Specifications.....	113
Digital Zoom Focal Length (35mm film equivalent)	113
Number of Shots/Recording Time, Playback Time	113
Number of Shots per Memory Card	114
Recording Time per Memory Card	114
Flash Range	114
Shooting Range.....	115
Continuous Shooting Speed.....	115
Shutter Speed	115
Aperture.....	115
Battery Pack NB-11LH.....	115
Battery Charger CB-2LF/CB-2LFE.....	115

Before Use
Basic Guide
Advanced Guide
1 Camera Basics
2 Auto Mode
3 Other Shooting Modes
4 P Mode
5 Playback Mode
6 Setting Menu
7 Accessories
8 Appendix
Index



Index..... 116
Trademarks and Licensing 118
Disclaimer..... 118

Before Use
Basic Guide
Advanced Guide
1 Camera Basics
2 Auto Mode
3 Other Shooting Modes
4 P Mode
5 Playback Mode
6 Setting Menu
7 Accessories
8 Appendix
Index

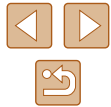

Common Camera Operations

Shoot

- Use camera-determined settings (Auto Mode)
 - 428

Shooting people well



Portraits
(43)



Against Snow
(43)

Matching specific scenes



Low Light
(43)



Fireworks
(43)

Applying special effects



Vivid Colors
(44)



Poster Effect
(44)



Fish-Eye Effect
(44)



Miniature Effect
(45)



Toy Camera Effect
(46)



Monochrome
(46)

- While adjusting image settings (Live View Control)
 - 42
- Focus on faces
 - 28, 43, 56
- Without using the flash (Flash Off)
 - 28
- Include yourself in the shot (Self-Timer)
 - 33, 47
- Add a date stamp
 - 35

View

- View images (Playback Mode)
 - 61
- Automatic playback (Slideshow)
 - 65
- On a TV
 - 87
- On a computer
 - 89
- Browse through images quickly
 - 63
- Erase images
 - 69

Shoot/View Movies

- Shoot movies
 - 28
- View movies (Playback Mode)
 - 61

Before Use

Basic Guide

Advanced Guide

1 Camera Basics

2 Auto Mode

3 Other Shooting Modes

4 P Mode

5 Playback Mode

6 Setting Menu

7 Accessories

8 Appendix

Index



Print

- Print pictures
 - 91

Save

- Save images to a computer
 - 90

Safety Precautions

- Before using the product, ensure that you read the safety precautions described below. Always ensure that the product is used correctly.
- The safety precautions noted here are intended to prevent you and other persons from being injured or incurring property damage.
- Be sure to also check the guides included with any separately sold accessories you use.



Warning

Denotes the possibility of serious injury or death.

- Do not trigger the flash in close proximity to people's eyes. Exposure to the intense light produced by the flash could damage eyesight. In particular, remain at least 1 meter (3.3 feet) away from infants when using the flash.

- Store this equipment out of the reach of children and infants. A strap wound around a child's neck may result in asphyxiation. If your product uses a power cord, mistakenly winding the cord around a child's neck may result in asphyxiation.

- Use only recommended power sources.
- Do not disassemble, alter, or apply heat to the product.
- Do not peel off the label, if the battery pack has one.
- Avoid dropping or subjecting the product to severe impacts.
- Do not touch the interior of the product if it is broken, such as when dropped.
- Stop using the product immediately if it emits smoke or a strange smell, or otherwise behaves abnormally.
- Do not use organic solvents such as alcohol, benzine, or thinner to clean the product.

Before Use

Basic Guide

Advanced Guide

1 Camera Basics

2 Auto Mode

3 Other Shooting Modes

4 P Mode

5 Playback Mode

6 Setting Menu

7 Accessories

8 Appendix

Index



- Avoid contact with liquid, and do not allow liquid or foreign objects inside.

This could result in electrical shock or fire.

If the product gets wet, or if liquid or foreign objects get inside, remove the battery pack/batteries or unplug immediately.

- Do not look through the viewfinder (if your model has one) at intense light sources, such as the sun on a clear day or an intense artificial light source.

This could damage your eyesight.

- Do not touch the product during thunderstorms if it is plugged in. This could result in electrical shock or fire. Immediately stop using the product and distance yourself from it.

- Use only the recommended battery pack/batteries.

- Do not place the battery pack/batteries near or in direct flame.

This may cause the battery pack/batteries to explode or leak, resulting in electrical shock, fire, or injuries. If leaking battery electrolyte comes into contact with eyes, mouth, skin, or clothing, immediately flush with water.

- If the product uses a battery charger, note the following precautions.
 - Remove the plug periodically and, using a dry cloth, wipe away any dust and dirt that has collected on the plug, the exterior of the power outlet, and the surrounding area.
 - Do not insert or remove the plug with wet hands.
 - Do not use the equipment in a manner that exceeds the rated capacity of the electrical outlet or wiring accessories. Do not use if the plug is damaged or not fully inserted in the outlet.
 - Do not allow dust or metal objects (such as pins or keys) to contact the terminals or plug.
 - Do not cut, damage, alter, or place heavy items on the power cord, if your product uses one.

This could result in electrical shock or fire.

- Turn the camera off in places where camera use is prohibited. The electromagnetic waves emitted by the camera may interfere with the operation of electronic instruments and other devices. Exercise adequate caution when using the product in places where use of electronic devices is restricted, such as inside airplanes and medical facilities.

- Do not allow the camera to maintain contact with skin for extended periods.

Even if the camera does not feel hot, this may cause low-temperature burns, manifested in redness of the skin or blistering. Use a tripod in hot places, or if you have poor circulation or insensitive skin.

	Caution	Denotes the possibility of injury.
--	----------------	------------------------------------

- When carrying the product by the strap, be careful not to bang it, subject it to strong impacts or shocks, or let it get caught on other objects.
- Be careful not to bump or push strongly on the lens. This could lead to injury or damage the camera.
- Be careful not to subject the screen to strong impacts. If the screen cracks, injury may result from the broken fragments.

- When using the flash, be careful not to cover it with your fingers or clothing. This could result in burns or damage to the flash.

- Avoid using, placing, or storing the product in the following places:
 - Places subject to direct sunlight
 - Places subject to temperatures above 40 °C (104 °F)
 - Humid or dusty places

These could cause leakage, overheating, or an explosion of the battery pack/batteries, resulting in electrical shock, fire, burns, or other injuries. Overheating and damage may result in electrical shock, fire, burns, or other injuries.

Before Use
Basic Guide
Advanced Guide
1 Camera Basics
2 Auto Mode
3 Other Shooting Modes
4 P Mode
5 Playback Mode
6 Setting Menu
7 Accessories
8 Appendix
Index

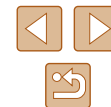

- The slideshow transition effects may cause discomfort when viewed for prolonged periods.

- When using optional lenses, lens filters, or filter adapters (if applicable), be sure to attach these accessories firmly.

If the lens accessory becomes loose and falls off, it may crack, and the shards of glass may lead to cuts.

- On products that raise and lower the flash automatically, make sure to avoid pinching your fingers with the lowering flash.

This could result in injury.

Caution

Denotes the possibility of property damage.

- Do not aim the camera at intense light sources, such as the sun on a clear day or an intense artificial light source.

Doing so may damage the image sensor or other internal components.

- When using the camera on a sandy beach or at a windy location, be careful not to allow dust or sand to enter the camera.
- On products that raise and lower the flash automatically, do not push the flash down or pry it open.

This may cause the product to malfunction.

- Wipe off any dust, grime, or other foreign matter on the flash with a cotton swab or cloth.

The heat emitted from the flash may cause foreign matter to smoke or the product to malfunction.

- Remove and store the battery pack/batteries when you are not using the product.

Any battery leakage that occurs may cause product damage.

- Before you discard the battery pack/batteries, cover the terminals with tape or other insulators.

Contacting other metal materials may lead to fire or explosions.

- Unplug any battery charger used with the product when not in use. Do not cover with a cloth or other objects when in use.

Leaving the unit plugged in for a long period of time may cause it to overheat and distort, resulting in fire.

- Do not leave any dedicated battery packs near pets. Pets biting the battery pack could cause leakage, overheating, or explosion, resulting in product damage or fire.

- If your product uses multiple batteries, do not use batteries that have different levels of charge together, and do not use old and new batteries together. Do not insert the batteries with the + and – terminals reversed.

This may cause the product to malfunction.

- Do not sit down with the camera in your pant pocket. Doing so may cause malfunctions or damage the screen.

- When putting the camera in your bag, ensure that hard objects do not come into contact with the screen. Also close the screen (so that it faces the body), if your product's screen closes.

- Do not attach any hard objects to the product. Doing so may cause malfunctions or damage the screen.

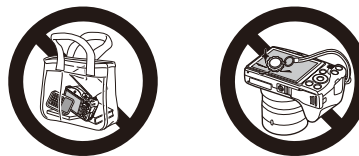

Before Use

Basic Guide

Advanced Guide

1 Camera Basics

2 Auto Mode

3 Other Shooting Modes

4 P Mode

5 Playback Mode

6 Setting Menu

7 Accessories

8 Appendix

Index



Basic Guide

Basic Operations

Basic information and instructions, from initial preparations to shooting and playback

Initial Preparations

Prepare for shooting as follows.

Attaching Accessories

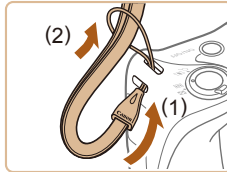

1 Attach the strap.

- Thread the end of the strap through the strap hole (1), and then pull the other end of the strap through the loop on the threaded end (2).

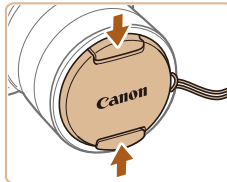

2 Attach the lens cap.

- Remove the lens cap from the lens momentarily, thread the end of the strap through the strap hole (1), and then pull the lens cap through the loop (2).
- Always remove the lens cap before turning the camera on.
- Keep the lens cap on the lens when the camera is not in use.

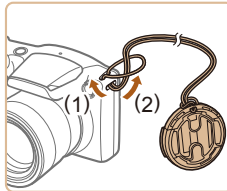

Before Use

Basic Guide

Advanced Guide

1 Camera Basics

2 Auto Mode

3 Other Shooting Modes

4 P Mode

5 Playback Mode

6 Setting Menu

7 Accessories

8 Appendix

Index

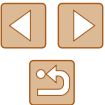

Holding the Camera



- Place the strap around your wrist.
- When shooting, keep your arms close to your body and hold the camera securely to prevent it from moving. If you have raised the flash, do not rest your fingers on it.

Charging the Battery Pack

Before use, charge the battery pack with the included charger. Be sure to charge the battery pack initially, because the camera is not sold with the battery pack charged.

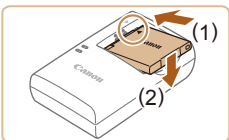

1 Insert the battery pack.

- After aligning the ▲ marks on the battery pack and charger, insert the battery pack by pushing it in (1) and down (2).

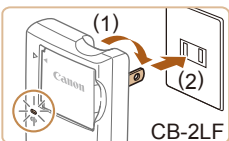

2 Charge the battery pack.

- CB-2LF: Flip out the plug (1) and plug the charger into a power outlet (2).
- CB-2LFE: Plug the power cord into the charger, then plug the other end into a power outlet.
- The charging lamp turns orange, and charging begins.
- When charging is finished, the lamp turns green.

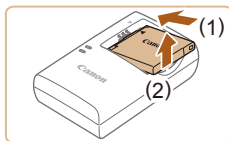
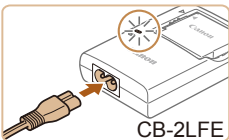

3 Remove the battery pack.

- After unplugging the battery charger, remove the battery pack by pushing it in (1) and up (2).



- To protect the battery pack and keep it in optimal condition, do not charge it continuously for more than 24 hours.
- For battery chargers that use a power cord, do not attach the charger or cord to other objects. Doing so could result in malfunction or damage to the product.



- For details on charging time and the number of shots and recording time possible with a fully charged battery pack, see “Number of Shots/Recording Time, Playback Time” (113).
- Charged battery packs gradually lose their charge, even when they are not used. Charge the battery pack on (or immediately before) the day of use.
- The charger can be used in areas with 100 – 240 V AC power (50/60 Hz). For power outlets in a different format, use a commercially available adapter for the plug. Never use an electrical transformer designed for traveling, which may damage the battery pack.

Before Use

Basic Guide

Advanced Guide

1 Camera Basics

2 Auto Mode

3 Other Shooting Modes

4 P Mode

5 Playback Mode

6 Setting Menu

7 Accessories

8 Appendix

Index



Inserting the Battery Pack and Memory Card

Insert the included battery pack and a memory card (sold separately). Note that before using a new memory card (or a memory card formatted in another device), you should format the memory card with this camera (p.80).

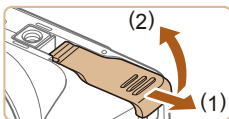

1 Open the cover.

- Slide the cover (1) and open it (2).

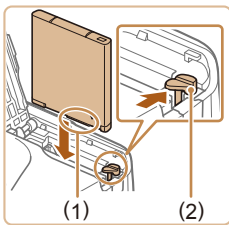

2 Insert the battery pack.

- Holding the battery pack with the terminals (1) facing as shown, press the battery lock (2) in the direction of the arrow and insert the battery pack until the lock clicks shut.
- If you insert the battery pack facing the wrong way, it cannot be locked into the correct position. Always confirm that the battery pack is facing the right way and locks when inserted.

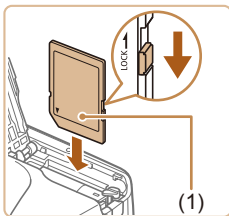

3 Check the card's write-protect tab and insert the memory card.

- Recording is not possible on memory cards with a write-protect tab when the tab is in the locked position. Slide the tab to the unlocked position.
- Insert the memory card with the label (1) facing as shown until it clicks into place.
- Make sure the memory card is facing the right way when you insert it. Inserting memory cards facing the wrong way may damage the camera.

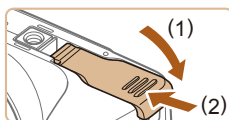

4 Close the cover.

- Lower the cover (1) and hold it down as you slide it, until it clicks into the closed position (2).



- For guidelines on how many shots or hours of recording can be saved on one memory card, see "Number of Shots per Memory Card" (p.114).

Removing the Battery Pack and Memory Card

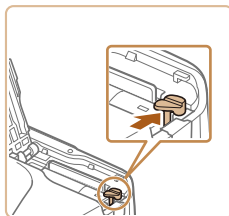

Remove the battery pack.

- Open the cover and press the battery lock in the direction of the arrow.
- The battery pack will pop up.

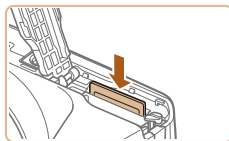

Remove the memory card.

- Push the memory card in until it clicks, and then slowly release it.
- The memory card will pop up.

Before Use

Basic Guide

Advanced Guide

1 Camera Basics

2 Auto Mode

3 Other Shooting Modes

4 P Mode

5 Playback Mode

6 Setting Menu

7 Accessories

8 Appendix

Index



Setting the Date and Time

Set the current date and time correctly as follows if the [Date/Time] screen is displayed when you turn the camera on. Information you specify this way is recorded in image properties when you shoot, and it is used when you manage images by shooting date or print images showing the date. You can also add a date stamp to shots, if you wish (135).

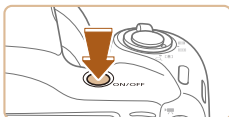

1 Turn the camera on.

- Press the ON/OFF button.
- The [Date/Time] screen is displayed.

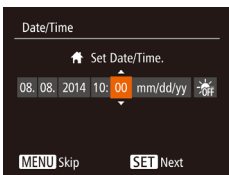

2 Set the date and time.

- Press the [◀][▶] buttons to choose an option.
- Press the [▲][▼] buttons to specify the date and time.
- When finished, press the [OK] button.

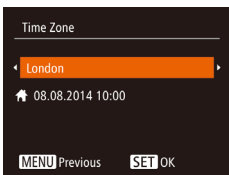

3 Specify your home time zone.

- Press the [◀][▶] buttons to choose your home time zone.

4 Finish the setup process.

- Press the [OK] button when finished. After a confirmation message, the setting screen is no longer displayed.
- To turn off the camera, press the ON/OFF button.



- Unless you set the date, time, and home time zone, the [Date/Time] screen will be displayed each time you turn the camera on. Specify the correct information.



- To set daylight saving time (1 hour ahead), choose [DST Off] in step 2 and then choose [DST On] by pressing the [▲][▼] buttons.

Changing the Date and Time

Adjust the date and time as follows.

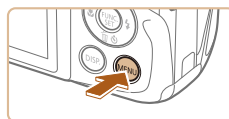

1 Access the menu screen.

- Press the [MENU] button.

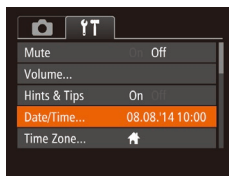

2 Choose [Date/Time].

- Move the zoom lever to choose the [↑] tab.
- Press the [▲][▼] buttons to choose [Date/Time], and then press the [OK] button.

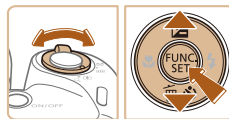

3 Change the date and time.

- Follow step 2 in “Setting the Date and Time” (17) to adjust the settings.
- Press the [MENU] button to close the menu screen.

Before Use

Basic Guide

Advanced Guide

1 Camera Basics

2 Auto Mode

3 Other Shooting Modes

4 P Mode

5 Playback Mode

6 Setting Menu

7 Accessories

8 Appendix

Index

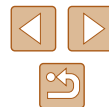



- Date/time settings can be retained for about 3 weeks by the camera's built-in date/time battery (backup battery) after the battery pack is removed.
- The date/time battery will be charged in about 4 hours once you insert a charged battery pack or connect the camera to an AC adapter kit (sold separately, 85), even if the camera is left off.
- Once the date/time battery is depleted, the [Date/Time] screen will be displayed when you turn the camera on. Set the correct date and time as described in "Setting the Date and Time" (17).

Display Language

Change the display language as needed.



1 Enter Playback mode.

- Press the [▶] button.

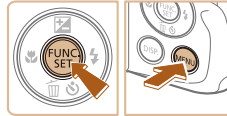

2 Access the setting screen.

- Press and hold the [Ⓜ] button, and then immediately press the [MENU] button.

English	Norsk	Română
Deutsch	Svenska	Türkçe
Français	Español	العربية
Nederlands	Ελληνικό	σπολιση
Dansk	Русский	简体中文
Português	Polski	繁體中文
Suomi	Čeština	한국어

3 Set the display language.

- Press the [▲][▼][◀][▶] buttons to choose a language, and then press the [Ⓜ] button.
- Once the display language has been set, the setting screen is no longer displayed.



- The current time is displayed if you wait too long in step 2 after pressing the [Ⓜ] button before you press the [MENU] button. In this case, press the [Ⓜ] button to dismiss the time display and repeat step 2.
- You can also change the display language by pressing the [MENU] button and choosing [Language] on the [FT] tab.

Before Use

Basic Guide

Advanced Guide

1 Camera Basics

2 Auto Mode

3 Other Shooting Modes

4 P Mode

5 Playback Mode

6 Setting Menu

7 Accessories

8 Appendix

Index



Trying the Camera Out

► Still Images ► Movies

Follow these instructions to turn the camera on, shoot still images or movies, and then view them.

Shooting (Smart Auto)

For fully automatic selection of the optimal settings for specific scenes, simply let the camera determine the subject and shooting conditions.



1 Turn the camera on.

- Press the ON/OFF button.
- The startup screen is displayed.



2 Enter [AUTO] mode.

- Press the [AUTO] button several times until [AUTO] is displayed.
- Aim the camera at the subject. The camera will make a slight clicking noise as it determines the scene.
- Icons representing the scene and image stabilization mode are displayed in the upper right of the screen.
- Frames displayed around any detected subjects indicate that they are in focus.

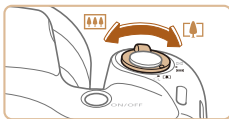

3 Compose the shot.

- To zoom in and enlarge the subject, move the zoom lever toward [T] (telephoto), and to zoom away from the subject, move it toward [W] (wide angle).

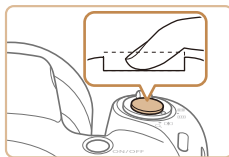
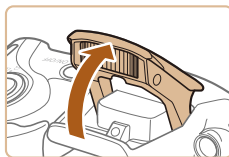
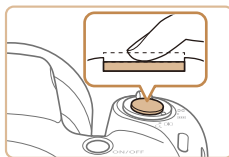

4 Shoot. Shooting Still Images

1) Focus.

- Press the shutter button lightly, halfway down. The camera beeps twice after focusing, and AF frames are displayed to indicate image areas in focus.
- If [Raise the flash] is displayed, lift the flash with your finger to prepare it for use. If you prefer not to use the flash, push it down with your finger, into the camera.

2) Shoot.

- Press the shutter button all the way down.
- As the camera shoots, a shutter sound is played, and in low-light conditions when you have raised the flash, it fires automatically.
- Keep the camera still until the shutter sound ends.
- After displaying your shot, the camera will revert to the shooting screen.

Before Use

Basic Guide

Advanced Guide

1 Camera Basics

2 Auto Mode

3 Other Shooting Modes

4 P Mode

5 Playback Mode

6 Setting Menu

7 Accessories

8 Appendix

Index





(1)

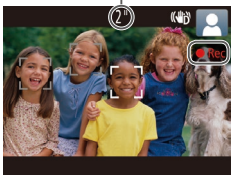

Shooting Movies

1) Start shooting.

- Press the movie button. The camera beeps once as recording begins, and [●Rec] is displayed with the elapsed time (1).
- Black bars are displayed on the top and bottom edges of the screen, and the subject is slightly enlarged. The black bars indicate image areas not recorded.
- Frames displayed around any detected faces indicate that they are in focus.
- Once recording begins, take your finger off the movie button.

2) Finish shooting.

- Press the movie button again to stop shooting. The camera beeps twice as recording stops.

Viewing

After shooting images or movies, you can view them on the screen as follows.



1 Enter Playback mode.

- Press the [▶] button.
- Your last shot is displayed.

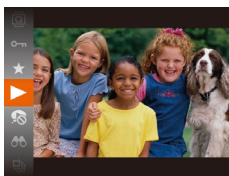
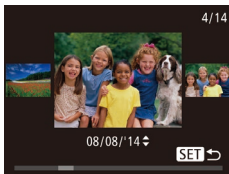

2 Browse through your images.

- To view the previous image, press the [◀] button. To view the next image, press the [▶] button.

- To access this screen (Scroll Display mode), press and hold the [◀][▶] buttons for at least one second. In this mode, press the [◀][▶] buttons to browse through images.
- To return to single-image display, press the [⊙] button.
- Movies are identified by a [SET ▶] icon. To play movies, go to step 3.

3 Play movies.

- Press the [⊙] button, press the [▲][▼] buttons to choose [▶], and then press the [⊙] button again.
- Playback now begins, and after the movie is finished, [SET ▶] is displayed.
- To adjust the volume, press the [▲][▼] buttons.

Before Use

Basic Guide

Advanced Guide

1 Camera Basics

2 Auto Mode

3 Other Shooting Modes

4 P Mode

5 Playback Mode

6 Setting Menu

7 Accessories

8 Appendix

Index





- To switch to Shooting mode from Playback mode, press the shutter button halfway.

Erasing Images

You can choose and erase unneeded images one by one. Be careful when erasing images, because they cannot be recovered.

1 Choose an image to erase.

- Press the [◀][▶] buttons to choose an image.



2 Erase the image.

- Press the [▼] button.
- After [Erase?] is displayed, press the [◀][▶] buttons to choose [Erase], and then press the [FUNC/SET] button.
- The current image is now erased.
- To cancel erasure, press the [◀][▶] buttons to choose [Cancel], and then press the [FUNC/SET] button.



- You can choose multiple images to erase at once (p.69).

Before Use

Basic Guide

Advanced Guide

1 Camera Basics

2 Auto Mode

3 Other Shooting Modes

4 P Mode

5 Playback Mode

6 Setting Menu

7 Accessories

8 Appendix

Index

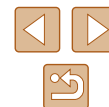

Advanced Guide

1

Camera Basics

Other basic operations and more ways to enjoy your camera, including shooting and playback options

On/Off

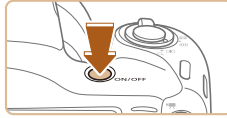

Shooting Mode

- Press the ON/OFF button to turn the camera on and prepare for shooting.
- To turn the camera off, press the ON/OFF button again.

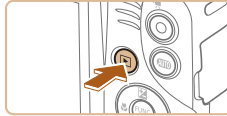

Playback Mode

- Press the [▶] button to turn the camera on and view your shots.
- To turn the camera off, press the [▶] button again.



- To switch to Playback mode from Shooting mode, press the [▶] button.
- To switch to Shooting mode from Playback mode, press the shutter button halfway (p. 23).
- The lens will be retracted after about one minute once the camera is in Playback mode. You can turn the camera off when the lens is retracted by pressing the [▶] button.

Before Use

Basic Guide

Advanced Guide

1 Camera Basics

2 Auto Mode

3 Other Shooting Modes

4 P Mode

5 Playback Mode

6 Setting Menu

7 Accessories

8 Appendix

Index

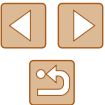

Power-Saving Features (Auto Power Down)

As a way to conserve battery power, the camera automatically deactivates the screen (Display Off) and then turns itself off after a specific period of inactivity.

Power Saving in Shooting Mode

The screen is automatically deactivated after about one minute of inactivity. In about two more minutes, the lens is retracted and the camera turns itself off. To activate the screen and prepare for shooting when the screen is off but the lens is still out, press the shutter button halfway (📖23).

Power Saving in Playback Mode

The camera turns itself off automatically after about five minutes of inactivity.



- You can deactivate Auto Power Down and adjust the timing of Display Off, if you prefer (📖79).
- Power saving is not active while the camera is connected to a computer (📖90).

Shutter Button

To ensure your shots are in focus, always begin by holding the shutter button halfway down, and once the subject is in focus, press the button all the way down to shoot.

In this manual, shutter button operations are described as pressing the button *halfway* or *all the way down*.

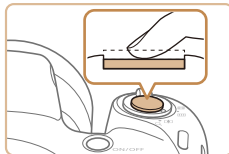

1 Press halfway. (Press lightly to focus.)

- Press the shutter button halfway. The camera beeps twice, and AF frames are displayed around image areas in focus.

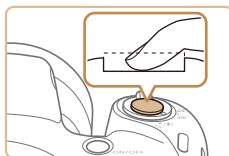

2 Press all the way down. (From the halfway position, press fully to shoot.)

- The camera shoots, as a shutter sound is played.
- Keep the camera still until the shutter sound ends.



- Images may be out of focus if you shoot without initially pressing the shutter button halfway.
- Length of shutter sound playback varies depending on the time required for the shot. It may take longer in some shooting scenes, and images will be blurry if you move the camera (or the subject moves) before the shutter sound ends.

Before Use

Basic Guide

Advanced Guide

1 Camera Basics

2 Auto Mode

3 Other Shooting Modes

4 P Mode

5 Playback Mode

6 Setting Menu

7 Accessories



8 Appendix

Index



Shooting Display Options

Press the [DISP] button to view other information on the screen, or to hide the information. For details on the information displayed, see “On-Screen Information” (104).

	Information is displayed
	No information is displayed



- Screen brightness is automatically increased by the night view function when you are shooting under low light, making it easier to check how shots are composed. However, on-screen image brightness may not match the brightness of your shots. Note that any on-screen image distortion or jerky subject motion will not affect recorded images.
- For playback display options, see “Switching Display Modes” (62).

Using the FUNC. Menu

Configure commonly used functions through the FUNC. menu as follows. Note that menu items and options vary depending on the shooting mode (107) or playback mode (112).



1 Access the FUNC. menu.

- Press the [FUNC.] button.

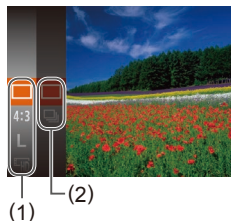

2 Choose a menu item.

- Press the [▲][▼] buttons to choose a menu item (1), and then press the [FUNC.] or [▶] button.
- Available options (2) are listed next to menu items, on the right.
- Depending on the menu item, functions can be specified simply by pressing the [FUNC.] or [▶] button, or another screen is displayed for configuring the function.

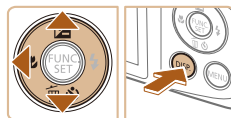

3 Choose an option.

- Press the [▲][▼] buttons to choose an option.
- Options labeled with a [DISP.] icon can be configured by pressing the [DISP.] button.
- To return to the menu items, press the [◀] button.

Before Use

Basic Guide

Advanced Guide

1 Camera Basics

2 Auto Mode

3 Other Shooting Modes

4 P Mode

5 Playback Mode

6 Setting Menu

7 Accessories

8 Appendix

Index

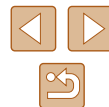



4 Finish the setup process.

- Press the [FUNC/SET] button.
- The screen before you pressed the [FUNC/SET] button in step 1 is displayed again, showing the option you configured.



- To undo any accidental setting changes, you can restore the camera's default settings (83).

Using the Menu Screen

Configure a variety of camera functions through the menu screen as follows. Menu items are grouped by purpose on tabs, such as shooting [CAMERA], playback [PLAY], and so on. Note that available menu items vary depending on the selected shooting or playback mode (109 – 112).



1 Access the menu screen.

- Press the [MENU] button.

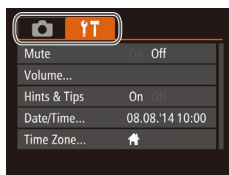

2 Choose a tab.

- Move the zoom lever to choose a tab.
- After you have pressed the [▲][▼] buttons to choose a tab initially, you can switch between tabs by pressing the [◀][▶] buttons.

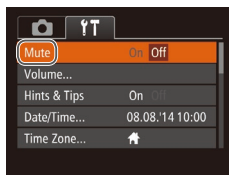
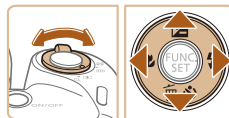

3 Choose a menu item.

- Press the [▲][▼] buttons to choose a menu item.
- For menu items with options not shown, first press the [FUNC/SET] or [▶] button to switch screens, and then press the [▲][▼] buttons to select the menu item.
- To return to the previous screen, press the [MENU] button.

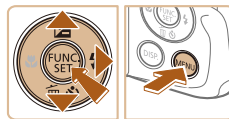

Before Use

Basic Guide

Advanced Guide

1 Camera Basics

2 Auto Mode

3 Other Shooting Modes

4 P Mode

5 Playback Mode

6 Setting Menu

7 Accessories

8 Appendix

Index



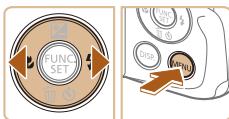
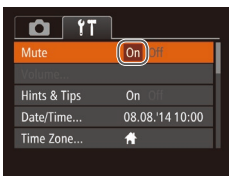

4 Choose an option.

- Press the [◀][▶] buttons to choose an option.

5 Finish the setup process.

- Press the [MENU] button to return to the screen displayed before you pressed the [MENU] button in step 1.



- To undo any accidental setting changes, you can restore the camera's default settings (83).

Indicator Display

The indicator on the back of the camera (3) lights up or blinks depending on the camera status.

Color	Indicator Status	Camera Status
Green	On	Connected to a computer (90), or display off (23, 79)
	Blinking	Starting up, recording/reading/transmitting images, or shooting long exposures (47)



- When the indicator blinks green, never turn the camera off, open the memory card/battery cover, or shake or jolt the camera, which may corrupt images or damage the camera or memory card.

Before Use

Basic Guide

Advanced Guide

1 Camera Basics

2 Auto Mode

3 Other Shooting Modes

4 P Mode

5 Playback Mode

6 Setting Menu

7 Accessories

8 Appendix

Index

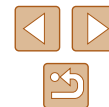

Clock

You can check the current time.



- Press and hold the [⌚] button.
- The current time appears.
- If you hold the camera vertically while using the clock function, it will switch to vertical display. Press the [◀][▶] buttons to change the display color.
- Press the [⌚] button again to cancel the clock display.



- When the camera is off, press and hold the [⌚] button, then press the ON/OFF button to display the clock.

Before Use

Basic Guide

Advanced Guide

1 Camera Basics

2 Auto Mode

3 Other Shooting Modes

4 P Mode

5 Playback Mode

6 Setting Menu

7 Accessories

8 Appendix

Index



2

Auto Mode

Convenient mode for easy shots with greater control over shooting

Shooting with Camera-Determined Settings

For fully automatic selection of the optimal settings for specific scenes, simply let the camera determine the subject and shooting conditions.

Shooting (Smart Auto)

▶ Still Images ▶ Movies



1 Turn the camera on.

- Press the ON/OFF button.
- The startup screen is displayed.



2 Enter [AUTO] mode.

- Press the [AUTO] button several times until [AUTO] is displayed.
- Aim the camera at the subject. The camera will make a slight clicking noise as it determines the scene.
- Icons representing the scene and image stabilization mode are displayed in the upper right of the screen (📖31, 📖32).
- Frames displayed around any detected subjects indicate that they are in focus.



Before Use

Basic Guide

Advanced Guide

1 Camera Basics

2 Auto Mode

3 Other Shooting Modes

4 P Mode

5 Playback Mode

6 Setting Menu

7 Accessories

8 Appendix

Index

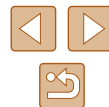

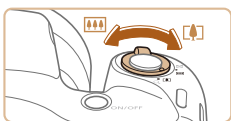

(1)



3 Compose the shot.

- To zoom in and enlarge the subject, move the zoom lever toward [1] (telephoto), and to zoom away from the subject, move it toward [4] (wide angle). (A zoom bar (1) showing the zoom position is displayed.)
- To zoom in or out quickly, move the zoom lever all the way toward [1] (telephoto) or [4] (wide angle), and to zoom in or out slowly, move it just a little in the desired direction.

4 Shoot.

Shooting Still Images

1) Focus.

- Press the shutter button halfway. The camera beeps twice after focusing, and AF frames are displayed to indicate image areas in focus.
- Several AF frames are displayed when multiple areas are in focus.

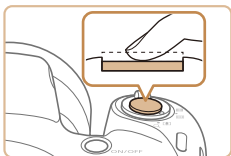

- If [Raise the flash] is displayed, lift the flash with your finger to prepare it for use. If you prefer not to use the flash, push it down with your finger, into the camera.

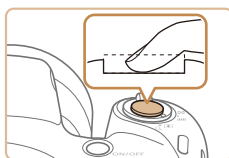
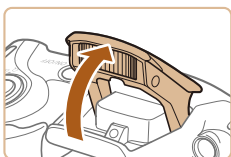

2) Shoot.

- Press the shutter button all the way down.
- As the camera shoots, a shutter sound is played, and in low-light conditions when you have raised the flash, it fires automatically.
- Keep the camera still until the shutter sound ends.
- After displaying your shot, the camera will revert to the shooting screen.



(1)

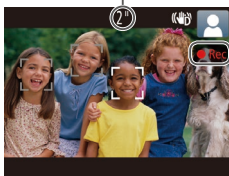

Shooting Movies

1) Start shooting.

- Press the movie button. The camera beeps once as recording begins, and [●Rec] is displayed with the elapsed time (1).
- Black bars are displayed on the top and bottom edges of the screen, and the subject is slightly enlarged. The black bars indicate image areas not recorded.
- Frames displayed around any detected faces indicate that they are in focus.
- Once recording begins, take your finger off the movie button.

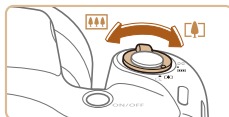

2) Resize the subject and recompose the shot as needed.

- To resize the subject, repeat the operations in step 3. However, note that the sound of camera operations will be recorded. Note that movies shot at zoom factors shown in blue will look grainy.
- When you recompose shots, the focus, brightness, and colors will be automatically adjusted.

Before Use

Basic Guide

Advanced Guide

1 Camera Basics

2 Auto Mode

3 Other Shooting Modes

4 P Mode

5 Playback Mode

6 Setting Menu

7 Accessories

8 Appendix

Index





3) Finish shooting.

- Press the movie button again to stop shooting. The camera beeps twice as recording stops.
- Recording will stop automatically when the memory card becomes full.

Still Images/Movies



- If the camera is turned on while the [DISP] button is held down, the camera will no longer sound. To activate sounds again, press the [MENU] button and choose [Mute] on the [] tab, and then press the [] buttons to choose [Off].

Still Images



- A blinking [] icon warns that images are more likely to be blurred by camera shake. In this case, mount the camera on a tripod or take other measures to keep it still.
- If your shots are dark despite the flash firing, move closer to the subject. For details on the flash range, see "Flash Range" (114).
- The subject may be too close if the camera only beeps once when you press the shutter button halfway. For details on the focusing range (shooting range), see "Shooting Range" (115).
- To reduce red-eye and to assist in focusing, the lamp may be activated when shooting in low-light conditions.
- A blinking [] icon displayed when you attempt to shoot indicates that shooting is not possible until the flash has finished recharging. Shooting can resume as soon as the flash is ready, so either press the shutter button all the way down and wait, or release it and press it again.
- Although you can shoot again before the shooting screen is displayed, your previous shot may determine the focus, brightness, and colors used.



- You can change how long images are displayed after shots (40).

Movies



- Before shooting a movie, lower the flash with your finger. Be careful not to touch the microphone (1) when shooting a movie. Leaving the flash raised, or blocking the microphone may prevent audio from being recorded or may cause the recording to sound muffled.

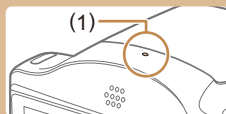

- Avoid touching camera controls other than the movie button when shooting movies, because sounds made by the camera will be recorded.
- Once movie recording begins, the image display area changes and subjects are enlarged to allow for correction of significant camera shake. To shoot subjects at the same size shown before shooting, adjust the image stabilization setting (60).



- Audio recording is monaural.

Before Use

Basic Guide

Advanced Guide

1 Camera Basics

2 Auto Mode

3 Other Shooting Modes

4 P Mode

5 Playback Mode

6 Setting Menu

7 Accessories

8 Appendix

Index



Scene Icons

► Still Images ► Movies

In [AUTO] mode, shooting scenes determined by the camera are indicated by the icon displayed, and corresponding settings are automatically selected for optimal focusing, subject brightness, and color.

Background	When Shooting People			Icon Background Color
	People	In Motion* ¹	Shadows on Face* ¹	
Bright				Gray
Bright and Backlit			–	
With Blue Sky				Light Blue
Blue Sky and Backlit			–	
Spotlights				Dark Blue
Dark				
Dark, Using Tripod		–	–	

Background	When Shooting Other Subjects			Icon Background Color
	Other Subjects	In Motion* ¹	At Close Range	
Bright	AUTO			Gray
Bright and Backlit				
With Blue Sky	AUTO			Light Blue
Blue Sky and Backlit				
Sunsets			–	Orange

Background	When Shooting Other Subjects			Icon Background Color
	Other Subjects	In Motion* ¹	At Close Range	
Spotlights				Dark Blue
Dark	AUTO	AUTO		
Dark, Using Tripod		–	–	

*1 Not displayed for movies.

*2 Displayed in dark scenes when the camera is held still, as when mounted on a tripod.



- Try shooting in [P] mode (p.49) if the scene icon does not match actual shooting conditions, or if it is not possible to shoot with your expected effect, color, or brightness.

Before Use

Basic Guide

Advanced Guide

1 Camera Basics

2 Auto Mode

3 Other Shooting Modes

4 P Mode

5 Playback Mode

6 Setting Menu

7 Accessories

8 Appendix









Index



Image Stabilization Icons

► Still Images ► Movies

Optimal image stabilization for the shooting conditions is automatically applied (Intelligent IS). Additionally, the following icons are displayed in [AUTO] mode.

	Image stabilization for still images (Normal)
	Image stabilization for still images when panning (Panning)*
	Image stabilization for macro shots. During movie recording,  is displayed, and image stabilization for macro movie recording is used (Hybrid IS).
	Image stabilization for movies, reducing strong camera shake, as when shooting while walking (Dynamic)
	Image stabilization for slow camera shake, such as when shooting movies at telephoto (Powered)
	No image stabilization, because the camera is mounted on a tripod or held still by other means. However, during movie recording,  is displayed, and image stabilization to counteract wind or other sources of vibration is used (Tripod IS).

* Displayed when you pan, following moving subjects with the camera. When you follow subjects moving horizontally, image stabilization only counteracts vertical camera shake, and horizontal stabilization stops. Similarly, when you follow subjects moving vertically, image stabilization only counteracts horizontal camera shake.



- To cancel image stabilization, set [IS Mode] to [Off] (📖60). In this case, an IS icon is not displayed.

On-Screen Frames

► Still Images ► Movies

A variety of frames are displayed once the camera detects subjects you are aiming the camera at.

- A white frame is displayed around the subject (or person's face) determined by the camera to be the main subject, and gray frames are displayed around other detected faces. Frames follow moving subjects within a certain range to keep them in focus. However, if the camera detects subject movement, only the white frame will remain on the screen.
- When you are pressing the shutter button halfway and the camera detects subject movement, a blue frame is displayed, and the focus and image brightness are constantly adjusted (Servo AF).



- Try shooting in [P] mode (📖49) if no frames are displayed, if frames are not displayed around desired subjects, or if frames are displayed on the background or similar areas.

Before Use

Basic Guide

Advanced Guide

1 Camera Basics

2 Auto Mode

3 Other Shooting Modes

4 P Mode

5 Playback Mode

6 Setting Menu

7 Accessories

8 Appendix

Index



Common, Convenient Features

► Still Images ► Movies

Zooming In Closer on Subjects (Digital Zoom)

When distant subjects are too far away to enlarge using the optical zoom, use digital zoom for up to about 160x enlargement.

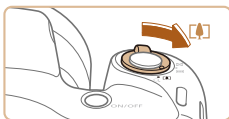

1 Move the zoom lever toward [Z].

- Hold the lever until zooming stops.
- Zooming stops at the largest possible zoom factor (before the image becomes noticeably grainy), which is then indicated on the screen.

2 Move the zoom lever toward [Z] again.

- The camera zooms in even closer on the subject.
- (1) is the current zoom factor.

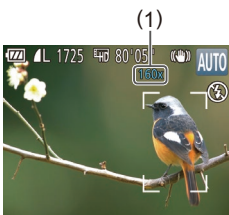

- Moving the zoom lever will display the zoom bar (which indicates the zoom position). The color of the zoom bar will change depending on the zoom range.
 - White range: optical zoom range where the image will not appear grainy.
 - Yellow range: digital zoom range where the image is not noticeably grainy (ZoomPlus).
 - Blue range: digital zoom range where the image will appear grainy.
- Because the blue range will not be available at some resolution settings (p.37), the maximum zoom factor can be achieved by following step 1.



- To deactivate digital zoom, choose MENU (p.25) ► [Camera] tab ► [Digital Zoom] ► [Off].

Using the Self-Timer

► Still Images ► Movies

With the self-timer, you can include yourself in group photos or other timed shots. The camera will shoot about 10 seconds after you press the shutter button.



1 Configure the setting.

- Press the [▼] button, press the [▲][▼] buttons to choose [Fn], and then press the [OK] button.
- Once the setting is complete, [Fn] is displayed.

2 Shoot.

- For Still Images: Press the shutter button halfway to focus on the subject, and then press it all the way down.
- For Movies: Press the movie button.

Before Use

Basic Guide

Advanced Guide

1 Camera Basics

2 Auto Mode

3 Other Shooting Modes

4 P Mode

5 Playback Mode

6 Setting Menu

7 Accessories

8 Appendix

Index



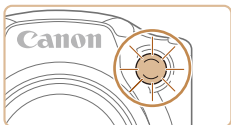

- Once you start the self-timer, the lamp will blink and the camera will play a self-timer sound.
- Two seconds before the shot, the blinking and sound will speed up. (The lamp will remain lit in case the flash fires.)
- To cancel shooting after you have triggered the self-timer, press the **[MENU]** button.
- To restore the original setting, choose **[Fn]** in step 1.

Using the Self-Timer to Avoid Camera Shake

► Still Images ► Movies

This option delays shutter release until about two seconds after you have pressed the shutter button. If the camera is unsteady while you are pressing the shutter button, it will not affect your shot.

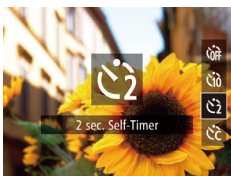

- Follow step 1 in “Using the Self-Timer” (33) and choose **[Fn]**.
- Once the setting is complete, **[Fn]** is displayed.
- Follow step 2 in “Using the Self-Timer” (33) to shoot.

Customizing the Self-Timer

► Still Images ► Movies

You can specify the delay (0 – 30 seconds) and number of shots (1 – 10).

1 Choose **[Fn]**.

- Following step 1 in “Using the Self-Timer” (33), choose **[Fn]** and press the **[MENU]** button immediately.

2 Configure the setting.

- Press the **[▲]**/**[▼]** buttons to choose [Delay] or [Shots].
- Press the **[◀]**/**[▶]** buttons to choose a value, and then press the **[SET]** button.
- Once the setting is complete, **[Fn]** is displayed.
- Follow step 2 in “Using the Self-Timer” (33) to shoot.



- For movies shot using the self-timer, [Delay] represents the delay before recording begins, but the [Shots] setting has no effect.



- When you specify multiple shots, image brightness and white balance are determined by the first shot. More time is required between shots when the flash fires or when you have specified to take many shots. Shooting will stop automatically when the memory card becomes full.
- When a delay longer than two seconds is specified, two seconds before the shot, the lamp blinking and self-timer sound will speed up. (The lamp will remain lit in case the flash fires.)

Before Use

Basic Guide

Advanced Guide

1 Camera Basics

2 Auto Mode

3 Other Shooting Modes

4 P Mode

5 Playback Mode

6 Setting Menu

7 Accessories

8 Appendix

Index



Adding a Date Stamp

► Still Images ► Movies

The camera can add the shooting date to images, in the lower-right corner. However, note that date stamps cannot be edited or removed, so confirm beforehand that the date and time are correct (📖17).

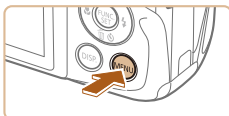

1 Configure the setting.

- Press the [MENU] button, choose [Date Stamp] on the [CAMERA] tab, and then choose the desired option (📖25).
- Once the setting is complete, [DATE] is displayed.

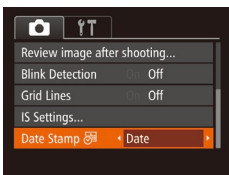

2 Shoot.

- As you take shots, the camera adds the shooting date or time to the lower-right corner of images.
- To restore the original setting, choose [Off] in step 1.



- Date stamps cannot be edited or removed.



- Shots taken without adding a date stamp can be printed with one as follows.
However, adding a date stamp this way to images that already have one may cause it to be printed twice.
 - Print using printer functions (📖91)
 - Use camera DPOF print settings (📖95) to print

Continuous Shooting

► Still Images ► Movies

Hold the shutter button all the way down to shoot continuously. For details on the continuous shooting speed, see “Continuous Shooting Speed” (📖115).



1 Configure the setting.

- Press the [FUNC SET] button, choose [CONT.] in the menu, and then choose [ON] (📖24).
- Once the setting is complete, [CONT.] is displayed.

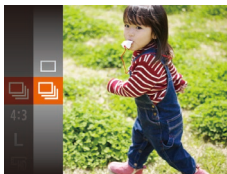

2 Shoot.

- Hold the shutter button all the way down to shoot continuously.

Before Use

Basic Guide

Advanced Guide

1 Camera Basics

2 Auto Mode

3 Other Shooting Modes

4 P Mode

5 Playback Mode

6 Setting Menu

7 Accessories

8 Appendix

Index





- During continuous shooting, focus and exposure are locked at the position/level determined when you pressed the shutter button halfway.
- Cannot be used with the self-timer (33).
- Shooting may stop momentarily or continuous shooting may slow down depending on shooting conditions, camera settings, and the zoom position.
- As more shots are taken, shooting may slow down.
- Shooting may slow down if the flash fires.

Image Customization Features

Changing the Aspect Ratio

► Still Images ► Movies

Change the image aspect ratio (ratio of width to height) as follows.



- Press the button, choose **[4:3]** in the menu, and choose the desired option (24).
- Once the setting is complete, the screen aspect ratio will be updated.
- To restore the original setting, repeat this process but choose **[4:3]**.

16:9	Same aspect ratio as widescreen HDTVs.
3:2	Same aspect ratio as 35mm film, used for printing images at 5 x 7-inch or postcard sizes.
4:3	Native aspect ratio of the camera screen, also used for display on standard-definition televisions or similar display devices, or for printing images at 3.5 x 5-inch or A-series sizes.
1:1	Square aspect ratio.

Before Use

Basic Guide

Advanced Guide

1 Camera Basics

2 Auto Mode

3 Other Shooting Modes

4 P Mode

5 Playback Mode

6 Setting Menu

7 Accessories

8 Appendix

Index



Changing Image Resolution (Size)

► Still Images ► Movies

Choose from 4 levels of image resolution, as follows. For guidelines on how many shots at each resolution setting can fit on a memory card, see “Number of Shots per Memory Card” (114).



- Press the [FUNC SET] button, choose [L] in the menu, and choose the desired option (124).
- The option you configured is now displayed.
- To restore the original setting, repeat this process but choose [L].



Guidelines for Choosing Resolution Based on Paper Size (for 4:3 Images)

L	A2 (16.5 x 23.4 in.)
M1	A3 – A5 (11.7 x 16.5 – 5.8 x 8.3 in.)
M2	3.5 x 5 in., 5 x 7 in., Postcard
S	For e-mailing and similar purposes

Changing Movie Image Quality

► Still Images ► Movies

2 image quality settings are available. For guidelines on the maximum movie length at each level of image quality that will fit on a memory card, see “Recording Time per Memory Card” (114).



- Press the [FUNC SET] button, choose [HD] in the menu, and choose the desired option (124).
- The option you configured is now displayed.
- To restore the original setting, repeat this process but choose [HD].



Image Quality	Resolution	Frame Rate	Details
[HD]	1280 x 720	25 fps	For shooting in HD
[VGA]	640 x 480	30 fps	For shooting in standard definition



- In [HD] mode, black bars displayed on the top and bottom edges of the screen indicate image areas not recorded.

Before Use

Basic Guide

Advanced Guide

1 Camera Basics

2 Auto Mode

3 Other Shooting Modes

4 P Mode

5 Playback Mode

6 Setting Menu

7 Accessories

8 Appendix

Index



Helpful Shooting Features

Displaying Grid Lines

► Still Images ► Movies

Grid lines can be displayed on the screen for vertical and horizontal reference while shooting.

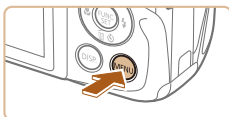

- Press the [MENU] button, choose [Grid Lines] on the [CAMERA] tab, and then choose [On] (p.25).
- Once the setting is complete, grid lines are displayed on the screen.
- To restore the original setting, repeat this process but choose [Off].

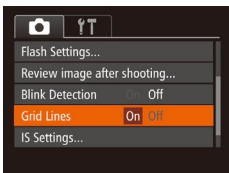

- Grid lines are not recorded in your shots.

Magnifying the Area in Focus

► Still Images ► Movies

You can check the focus by pressing the shutter button halfway, which will enlarge the portion of the image in focus in the AF frame.



1 Configure the setting.

- Press the [MENU] button, choose [AF-Point Zoom] on the [CAMERA] tab, and then choose [On] (p.25).

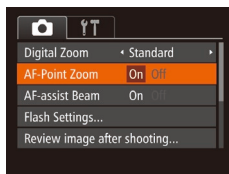

2 Check the focus.

- Press the shutter button halfway. The face detected as the main subject is now magnified.
- To restore the original setting, choose [Off] in step 1.



- The area in focus is not magnified in the following cases when the shutter button is pressed halfway.
 - If a face was not detected, if the person is too close to the camera and their face is too large for the screen, or if the camera detects subject movement
 - When digital zoom is used (p.33)
 - When Tracking AF is used (p.56)
 - When a TV is used as a display (p.87)

Before Use

Basic Guide

Advanced Guide

1 Camera Basics

2 Auto Mode

3 Other Shooting Modes

4 P Mode

5 Playback Mode

6 Setting Menu

7 Accessories

8 Appendix

Index



Checking for Closed Eyes

► Still Images ► Movies

 is displayed when the camera detects that people may have closed their eyes.

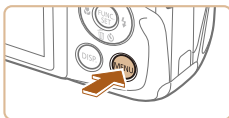

1 Configure the setting.

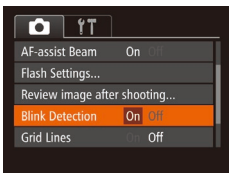

- Press the [MENU] button, choose [Blink Detection] on the  tab, and then choose [On] (25).





2 Shoot.

-  flashes when the camera detects a person whose eyes are closed.
- To restore the original setting, choose [Off] in step 1.



- When you have specified multiple shots in  mode, this function is only available for the final shot.
- A frame is displayed around people whose eyes are closed when you have selected [2 sec.], [4 sec.], [8 sec.], or [Hold] in [Display Time] (40).
- This feature is not available in continuous shooting mode (35).

Customizing Camera Operation



Customize shooting functions on the  tab of the menu screen as follows.
For instructions on menu functions, see “Using the Menu Screen” (25).

Deactivating the AF-Assist Beam

► Still Images ► Movies

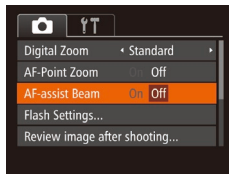
You can deactivate the lamp that normally lights up to help you focus when you press the shutter button halfway in low-light conditions.



- Press the [MENU] button, choose [AF-assist Beam] on the  tab, and then choose [Off] (25).
- To restore the original setting, repeat this process but choose [On].

Before Use

Basic Guide

Advanced Guide

1 Camera Basics

2 Auto Mode

3 Other Shooting Modes

4 P Mode

5 Playback Mode

6 Setting Menu

7 Accessories

8 Appendix

Index



Deactivating the Red-Eye Reduction Lamp

► Still Images ► Movies

You can deactivate the red-eye reduction lamp that lights up to reduce red-eye when the flash is used in low-light shots.

1 Access the [Flash Settings] screen.

- Press the [MENU] button, choose [Flash Settings] on the [📷] tab, and then press the [ⓘ] button (📖25).

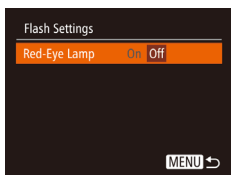

2 Configure the setting.

- Choose [Off] for [Red-Eye Lamp] (📖25).
- To restore the original setting, repeat this process but choose [On].

Changing the Image Display Style after Shots

► Still Images ► Movies

You can change how long images are displayed and what information is displayed immediately after shooting.

Changing the Image Display Period after Shots

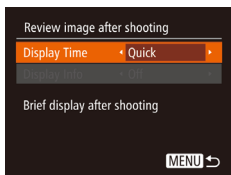

1 Access the [Review image after shooting] screen.

- Press the [MENU] button, choose [Review image after shooting] on the [📷] tab, and then press the [ⓘ] button (📖25).

2 Configure the setting.

- Press the [▲][▼] buttons to choose [Display Time]. Press the [◀][▶] buttons to choose the desired option.
- To restore the original setting, repeat this process but choose [Quick].

Quick	Displays images only until you can shoot again.
2 sec., 4 sec., 8 sec.	Displays images for the specified time. Even while the shot is displayed, you can take another shot by pressing the shutter button halfway again.
Hold	Displays images until you press the shutter button halfway.
Off	No image display after shots.

Changing the Screen Displayed after Shots

Change the way images are displayed after shots as follows.

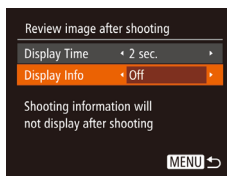

1 Set [Display Time] to [2 sec.], [4 sec.], [8 sec.], or [Hold] (📖40).

2 Configure the setting.

- Press the [▲][▼] buttons to choose [Display Info]. Press the [◀][▶] buttons to choose the desired option.
- To restore the original setting, repeat this process but choose [Off].

Off	Displays only the image.
Detailed	Displays shooting details (📖105).

Before Use

Basic Guide

Advanced Guide

1 Camera Basics

2 Auto Mode

3 Other Shooting Modes

4 P Mode

5 Playback Mode

6 Setting Menu

7 Accessories

8 Appendix

Index





- When [Display Time] (📖40) is set to [Off] or [Quick], [Display Info] is set to [Off] and cannot be changed.
- By pressing the [DISP] button while an image is displayed after shooting, you can switch the display information. Note that the settings of [Display Info] are not changed. You can also erase images by pressing the [▼] button, or protect (📖67) or tag images as favorites (📖72) by pressing the (📖) button.

Before Use

Basic Guide

Advanced Guide

1 Camera Basics

2 Auto Mode

3 Other Shooting Modes

4 P Mode

5 Playback Mode

6 Setting Menu

7 Accessories

8 Appendix

Index

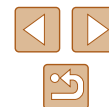

3

Other Shooting Modes

Shoot more effectively in various scenes, and take shots enhanced with unique image effects or captured using special functions

Brightness / Color Customization (Live View Control)

► Still Images ► Movies

Image brightness or colors when shooting can be easily customized as follows.



1 Enter [LIVE] mode.

- Press the [AUTO] button several times until [LIVE] is displayed.

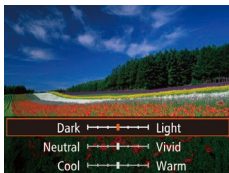

2 Configure the setting.

- Press the [DISP] button to access the setting screen. Press the [▲][▼] buttons to choose a setting item, and then press the [◀][▶] buttons to adjust the value as you watch the screen.
- Press the [⊞] button.

3 Shoot.

Brightness	For brighter images, adjust the level to the right, and for darker images, adjust it to the left.
Color	For more vivid images, adjust the level to the right, and for more subdued images, adjust it to the left.
Tone	For a warm, reddish tone, adjust the level to the right, and for a cool, bluish tone, adjust it to the left.

Before Use

Basic Guide

Advanced Guide

1 Camera Basics

2 Auto Mode

3 Other Shooting Modes

4 P Mode

5 Playback Mode

6 Setting Menu

7 Accessories

8 Appendix

Index

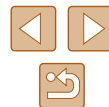

Specific Scenes

Choose a mode matching the shooting scene, and the camera will automatically configure the settings for optimal shots.



1 Choose a shooting mode.

- Press the [AUTO] button several times until [LIVE] is displayed.
- Press the [MENU] button, choose [LIVE] in the menu, and choose the desired option (p.24).

2 Shoot.

Shooting Portraits (Portrait)

▶ Still Images ▶ Movies



- Take shots of people with a softening effect.

Shooting under Low Light (Low Light)

▶ Still Images ▶ Movies



- Shoot with minimal camera and subject shake even in low-light conditions.



Shooting with Snowy Backgrounds (Snow)

▶ Still Images ▶ Movies

- Bright, natural-colored shots of people against snowy backgrounds.



Shooting Fireworks (Fireworks)

▶ Still Images ▶ Movies

- Vivid shots of fireworks.



- In [SNOW] mode, mount the camera on a tripod or take other measures to keep it still and prevent camera shake. Additionally, you should set [IS Mode] to [Off] when using a tripod or other means to secure the camera (p.60).



- [LOW LIGHT] mode resolution is [M] (2304 x 1728) and cannot be changed.
- In [FIREWORKS] mode, although no frames are displayed when you press the shutter button halfway, optimal focus is still determined.

Before Use

Basic Guide

Advanced Guide

1 Camera Basics

2 Auto Mode

3 Other Shooting Modes

4 P Mode

5 Playback Mode

6 Setting Menu

7 Accessories

8 Appendix

Index



Applying Special Effects

Add a variety of effects to images when shooting.

1 Choose a shooting mode.

- Follow step 1 in “Specific Scenes” (43) to choose a shooting mode.

2 Shoot.

Shooting in Vivid Colors (Super Vivid)

▶ Still Images ▶ Movies

- Shots in rich, vivid colors.





Posterized Shots (Poster Effect)

▶ Still Images ▶ Movies

- Shots that resemble an old poster or illustration.



- In  and  modes, try taking some test shots first, to make sure you obtain the desired results.

Shooting with a Fish-Eye Lens Effect (Fish-Eye Effect)

▶ Still Images ▶ Movies

Shoot with the distorting effect of a fish-eye lens.

1 Choose .

- Follow step 1 in “Specific Scenes” (43) and choose .

2 Choose an effect level.

- Press the [DISP] button, press the [◀][▶] buttons to choose an effect level, and then press the [DISP] button again.
- A preview is shown of how your shot will look with the effect applied.

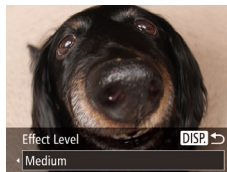

3 Shoot.



- Try taking some test shots first, to make sure you obtain the desired results.

Before Use

Basic Guide

Advanced Guide

1 Camera Basics

2 Auto Mode

3 Other Shooting Modes

4 P Mode

5 Playback Mode

6 Setting Menu

7 Accessories

8 Appendix

Index



Shots Resembling Miniature Models (Miniature Effect)

► Still Images ► Movies

Creates the effect of a miniature model, by blurring image areas above and below your selected area.

You can also make movies that look like scenes in miniature models by choosing the playback speed before the movie is recorded. People and objects in the scene will move quickly during playback. Note that sound is not recorded.

1 Choose [ZOOM].

- Follow step 1 in “Specific Scenes” (📖43) and choose [ZOOM].
- A white frame is displayed, indicating the image area that will not be blurred.



2 Choose the area to keep in focus.

- Press the [DISP] button.
- Move the zoom lever to resize the frame, and press the [▲][▼] buttons to move it.



3 For movies, choose the movie playback speed.

- Press the [MENU] button, and then press the [◀][▶] buttons to choose the speed.

4 Return to the shooting screen and shoot.

- Press the [MENU] button to return to the shooting screen, and then shoot.

Playback Speed and Estimated Playback Time (for One-Minute Clips)

Speed	Playback Time
5x	Approx. 12 sec.
10x	Approx. 6 sec.
20x	Approx. 3 sec.



- The zoom is not available when shooting movies. Be sure to set the zoom before shooting.
- Try taking some test shots first, to make sure you obtain the desired results.



- To switch the orientation of the frame (from horizontal to vertical or vice-versa), press the [FRM] button in step 2. You can move the frame in vertical orientation by pressing the [◀][▶] buttons.
- Holding the camera vertically will change the orientation of the frame.
- Movie image quality is [EVA] at an aspect ratio of [4:3] and [EHD] at an aspect ratio of [16:9] (📖36). These quality settings cannot be changed.

Before Use

Basic Guide

Advanced Guide

1 Camera Basics

2 Auto Mode

3 Other Shooting Modes

4 P Mode

5 Playback Mode

6 Setting Menu

7 Accessories

8 Appendix

Index



Shooting with a Toy Camera Effect (Toy Camera Effect)

▶ Still Images ▶ Movies

This effect makes images resemble shots from a toy camera by vignetting (darker, blurred image corners) and changing the overall color.

1 Choose [📷].

- Follow step 1 in “Specific Scenes” (📖43) and choose [📷].



2 Choose a color tone.

- Press the [DISP] button, press the [◀][▶] buttons to choose a color tone, and then press the [DISP] button again.
- A preview is shown of how your shot will look with the effect applied.

3 Shoot.

Standard	Shots resemble toy camera images.
Warm	Images have a warmer tone than with [Standard].
Cool	Images have a cooler tone than with [Standard].



- Try taking some test shots first, to make sure you obtain the desired results.

Shooting in Monochrome

▶ Still Images ▶ Movies

Shoot images in black and white, sepia, or blue and white.

1 Choose [📷].

- Follow step 1 in “Specific Scenes” (📖43) and choose [📷].

2 Choose a color tone.

- Press the [DISP] button, press the [◀][▶] buttons to choose a color tone, and then press the [DISP] button again.
- A preview is shown of how your shot will look with the effect applied.



3 Shoot.

B/W	Black and white shots.
Sepia	Sepia tone shots.
Blue	Blue and white shots.

Before Use

Basic Guide

Advanced Guide

1 Camera Basics

2 Auto Mode

3 Other Shooting Modes

4 P Mode

5 Playback Mode

6 Setting Menu

7 Accessories

8 Appendix

Index



Special Modes for Other Purposes

Using the Face Self-Timer

► Still Images ► Movies

The camera will shoot about two seconds after detecting that the face of another person (such as the photographer) has entered the shooting area (📖56). This is useful when including yourself in group photos or similar shots.



1 Choose [👤].

- Follow step 1 in “Specific Scenes” (📖43) and choose [👤].

2 Compose the shot and press the shutter button halfway.

- Make sure a green frame is displayed around the face you focus on and white frames around other faces.

3 Press the shutter button all the way down.

- The camera now enters shooting standby mode, and [Look straight at camera to start count down] is displayed.
- The lamp blinks and the self-timer sound is played.



4 Join the subjects in the shooting area and look at the camera.

- After the camera detects a new face, the lamp blinking and self-timer sound will speed up. (When the flash fires, the lamp will remain lit.) About two seconds later, the camera will shoot.
- To cancel shooting after you have triggered the self-timer, press the [MENU] button.



- Even if your face is not detected after you join the others in the shooting area, the camera will shoot about 15 seconds later.
- To change the number of shots, after choosing [👤] in step 1, press the [DISP.] button, press the [◀|▶] buttons to choose the number of shots, and then press the [DISP.] button again. [Blink Detection] (📖39) is only available for the final shot.

Shooting Long Exposures (Long Shutter)

► Still Images ► Movies

Specify a shutter speed of 1 – 15 seconds to shoot long exposures. In this case, mount the camera on a tripod or take other measures to prevent camera shake.

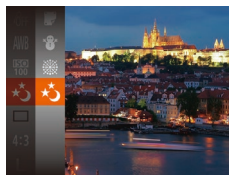

1 Choose [🌟].

- Follow step 1 in “Specific Scenes” (📖43) and choose [🌟].

Before Use

Basic Guide

Advanced Guide

1 Camera Basics

2 Auto Mode

3 Other Shooting Modes

4 P Mode

5 Playback Mode

6 Setting Menu

7 Accessories

8 Appendix

Index



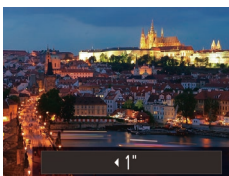

2 Choose the shutter speed.

- Press the [▲] button, press the [◀][▶] buttons to choose the shutter speed, and then press the [Ⓢ] button.

3 Check the exposure.

- Press the shutter button halfway to view the exposure for your selected shutter speed.

4 Shoot.



- On-screen image brightness in step 3, when you pressed the shutter button halfway, may not match the brightness of your shots.
- With shutter speeds of 1.3 seconds or slower, there will be a delay before you can shoot again, as the camera processes images to reduce noise.
- Set [IS Mode] to [Off] when using a tripod or other means to secure the camera (📖60).



- If the flash fires, your shot may be overexposed. In this case, set the flash to [🚫] and shoot again (📖58).

Before Use

Basic Guide

Advanced Guide

1 Camera Basics

2 Auto Mode

3 Other Shooting Modes

4 P Mode

5 Playback Mode

6 Setting Menu

7 Accessories

8 Appendix

Index



4

P Mode

More discerning shots, in your preferred shooting style

- Instructions in this chapter apply to the camera when set to **[P]** mode.
- **[P]**: Program AE; AE: Auto Exposure
- Before using a function introduced in this chapter in modes other than **[P]**, make sure the function is available in that mode (📖106).

Shooting in Program AE ([P] Mode)

▶ Still Images ▶ Movies

You can customize many function settings to suit your preferred shooting style.



1 Enter [P] mode.

- Follow step 1 in “Specific Scenes” (📖43) and choose **[P]**.

2 Customize the settings as desired (📖50 – 📖60), and then shoot.



- If adequate exposure cannot be obtained when you press the shutter button halfway, shutter speeds and aperture values are displayed in orange. In this case, try adjusting the ISO speed (📖51) or activating the flash (if subjects are dark, 📖58), which may enable adequate exposure.
- Movies can be recorded in **[P]** mode as well, by pressing the movie button. However, some FUNC. (📖24) and MENU (📖25) settings may be automatically adjusted for movie recording.

Before Use

Basic Guide

Advanced Guide

1 Camera Basics

2 Auto Mode

3 Other Shooting Modes

4 P Mode

5 Playback Mode

6 Setting Menu

7 Accessories

8 Appendix

Index

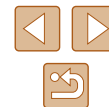

Image Brightness (Exposure)

Adjusting Image Brightness (Exposure Compensation)

► Still Images ► Movies

The standard exposure set by the camera can be adjusted in 1/3-stop increments, in a range of -2 to +2.



- Press the [▲] button. As you watch the screen, press the [◀][▶] buttons to adjust brightness.
- When shooting movies, shoot with the exposure compensation bar displayed.
- When shooting still images, press the [⊕] button to display the set exposure compensation amount, and then shoot.



- You can also shoot still images with exposure compensation bar displayed.
- While recording a movie, [AEL] is displayed, and the exposure is locked.

Locking Image Brightness / Exposure (AE Lock)

► Still Images ► Movies

Before shooting, you can lock the exposure, or you can specify focus and exposure separately.

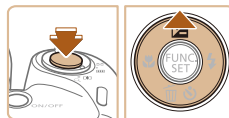

1 Lock the exposure.

- Aim the camera at the subject to shoot with the exposure locked. With the shutter button pressed halfway, press the [▲] button.
- [AEL] is displayed, and the exposure is locked.
- To unlock AE, release the shutter button and press the [▲] button again. In this case, [AEL] is no longer displayed.

2 Compose the shot and shoot.



- AE: Auto Exposure

Before Use

Basic Guide

Advanced Guide

1 Camera Basics

2 Auto Mode

3 Other Shooting Modes

4 P Mode

5 Playback Mode

6 Setting Menu

7 Accessories

8 Appendix

Index



Changing the Metering Method

► Still Images ► Movies

Adjust the metering method (how brightness is measured) to suit shooting conditions as follows.



- Press the button, choose in the menu, and choose the desired option (24).
- The option you configured is now displayed.

	Evaluative	For typical shooting conditions, including backlit shots. Automatically adjusts exposure to match the shooting conditions.
	Center Weighted Avg.	Determines the average brightness of light across the entire image area, calculated by treating brightness in the central area as more important.
	Spot	Metering restricted to within the (Spot AE Point frame), displayed in the center of the screen.

Changing the ISO Speed

► Still Images ► Movies

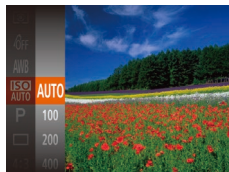

- Press the button, choose in the menu, and choose the desired option (24).
- The option you configured is now displayed.

AUTO	Automatically adjusts the ISO speed to suit the shooting mode and conditions.	
100, 200	Low	For shooting outdoors in fair weather.
400, 800	Slightly Low	For shooting in cloudy conditions, or at twilight.
1600	Slightly High	For shooting night scenes, or in dark rooms.



- To view the automatically determined ISO speed when you have set the ISO speed to [AUTO], press the shutter button halfway.
- Although choosing a lower ISO speed may reduce image graininess, there may be a greater risk of subject and camera shake in some shooting conditions.
- Choosing a higher ISO speed will increase shutter speed, which may reduce subject and camera shake and increase the flash range. However, shots may look grainy.

Before Use

Basic Guide

Advanced Guide

1 Camera Basics

2 Auto Mode

3 Other Shooting Modes

4 P Mode

5 Playback Mode

6 Setting Menu

7 Accessories

8 Appendix

Index



Correcting Image Brightness (i-Contrast)

► Still Images ► Movies

Before shooting, excessively bright or dark image areas (such as faces or backgrounds) can be detected and automatically adjusted to the optimal brightness. Insufficient overall image contrast can also be automatically corrected before shooting to make subjects stand out better.

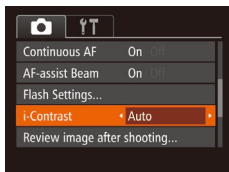

- Press the [MENU] button, choose [i-Contrast] on the [CAMERA] tab, and then choose [Auto] (📖25).
- Once the setting is complete, [Ci] is displayed.



- Under some shooting conditions, correction may be inaccurate or may cause images to appear grainy.



- You can also correct existing images (📖75).

Image Colors

Adjusting White Balance

► Still Images ► Movies

By adjusting white balance (WB), you can make image colors look more natural for the scene you are shooting.

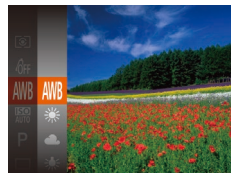

- Press the [WB] button, choose [AWB] in the menu, and choose the desired option (📖24).
- The option you configured is now displayed.

AWB	Auto	Automatically sets the optimal white balance for the shooting conditions.
	Day Light	For shooting outdoors in fair weather.
	Cloudy	For shooting in cloudy weather or at twilight.
	Tungsten	For shooting under ordinary incandescent lighting.
	Fluorescent	For shooting under white fluorescent lighting.
	Fluorescent H	For shooting under daylight fluorescent lighting.
	Custom	For manually setting a custom white balance (📖53).

Before Use

Basic Guide

Advanced Guide

1 Camera Basics

2 Auto Mode

3 Other Shooting Modes

4 P Mode

5 Playback Mode

6 Setting Menu

7 Accessories

8 Appendix

Index



Custom White Balance

► Still Images ► Movies

For image colors that look natural under the light in your shot, adjust white balance to suit the light source where you are shooting. Set the white balance under the same light source that will illuminate your shot.

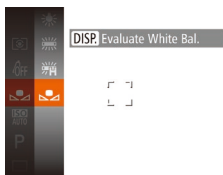

- Follow the steps in “Adjusting White Balance” (📖52) to choose [WB].
- Aim the camera at a plain white subject, so that the entire screen is white. Press the [DISP] button.
- The tint of the screen changes once the white balance data has been recorded.



- Colors may look unnatural if you change camera settings after recording white balance data.

Changing Image Color Tones (My Colors)

► Still Images ► Movies

Change image color tones as desired, such as converting images to sepia or black and white.

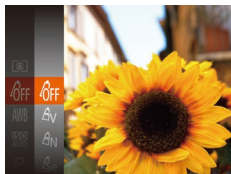

- Press the [MENU] button, choose [OFF] in the menu, and choose the desired option (📖24).
- The option you configured is now displayed.

[OFF]	My Colors Off	–
[V]	Vivid	Emphasizes contrast and color saturation, making images sharper.
[N]	Neutral	Tones down contrast and color saturation for subdued images.
[Se]	Sepia	Creates sepia tone images.
[B/W]	B/W	Creates black and white images.
[P]	Positive Film	Combines the effects of Vivid Blue, Vivid Green, and Vivid Red to produce intense yet natural-looking colors resembling images on positive film.
[L]	Lighter Skin Tone	Lightens skin tones.
[D]	Darker Skin Tone	Darkens skin tones.
[B]	Vivid Blue	Emphasizes blues in images. Makes the sky, ocean, and other blue subjects more vivid.
[G]	Vivid Green	Emphasizes greens in images. Makes mountains, foliage, and other green subjects more vivid.
[R]	Vivid Red	Emphasizes reds in images. Makes red subjects more vivid.
[C]	Custom Color	Adjust contrast, sharpness, color saturation, and other qualities as desired (📖54).



- White balance (📖52) cannot be set in [Se] or [B/W] modes.
- With [L] and [D] modes, colors other than people's skin tone may change. These settings may not produce the expected results with some skin tones.

Before Use

Basic Guide

Advanced Guide

1 Camera Basics

2 Auto Mode

3 Other Shooting Modes

4 P Mode

5 Playback Mode

6 Setting Menu

7 Accessories

8 Appendix

Index



Custom Color

▶ Still Images ▶ Movies

Choose the desired level of image contrast, sharpness, color saturation, red, green, blue, and skin tones in a range of 1 – 5.

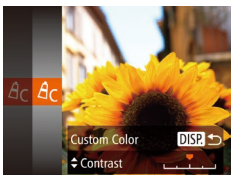

1 Access the setting screen.

- Follow the steps in “Changing Image Color Tones (My Colors)” (p. 53) to choose [Ac], and then press the [DISP] button.

2 Configure the setting.

- Press the [▲][▼] buttons to choose an option, and then specify the value by pressing the [◀][▶] buttons.
- For stronger/more intense effects (or darker skin tones), adjust the value to the right, and for weaker/lighter effects (or lighter skin tones), adjust the value to the left.
- Press the [DISP] button to complete the setting.

Shooting Range and Focusing

Shooting Close-Ups (Macro)

▶ Still Images ▶ Movies

To restrict the focus to subjects at close range, set the camera to [🌻]. For details on the focusing range, see “Shooting Range” (p. 115).

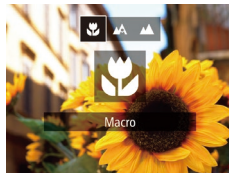

- Press the [◀] button, press the [◀][▶] buttons to choose [🌻], and then press the [⊕] button.
- Once the setting is complete, [🌻] is displayed.



- If the flash fires, vignetting may occur.
- Be careful to avoid damaging the lens.
- In the yellow bar display area below the zoom bar, [🌻] will turn gray and the camera will not focus.



- To prevent camera shake, try mounting the camera on a tripod and shooting with the camera set to [🌻] (p. 34).

Before Use

Basic Guide

Advanced Guide

1 Camera Basics

2 Auto Mode

3 Other Shooting Modes

4 P Mode

5 Playback Mode

6 Setting Menu

7 Accessories

8 Appendix

Index

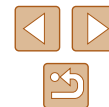

Shooting Distant Subjects (Infinity)

▶ Still Images ▶ Movies

To restrict the focus to distant subjects, set the camera to [∞]. For details on the focusing range, see “Shooting Range” (📖115).

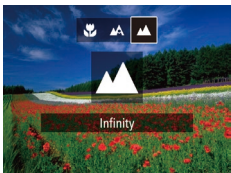

- Press the [◀] button, press the [◀|▶] buttons to choose [∞], and then press the [OK] button.
- Once the setting is complete, [∞] is displayed.

Digital Tele-Converter

▶ Still Images ▶ Movies

The focal length of the lens can be increased by approximately 1.6x or 2.0x. This can reduce camera shake because the shutter speed is faster than it would be if you zoomed (including using digital zoom) in to the same zoom factor.

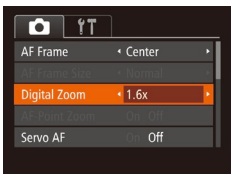

- Press the [MENU] button, choose [Digital Zoom] on the [📷] tab, and then choose the desired option (📖25).
- The view is enlarged and the zoom factor is displayed on the screen.



- The digital tele-converter cannot be used with digital zoom (📖33) or AF-point zoom (📖38).



- The shutter speed may be equivalent when you move the zoom lever all the way toward [📷] for maximum telephoto, and when you zoom in to enlarge the subject to the same size following step 2 in “Zooming In Closer on Subjects (Digital Zoom)” (📖33).

Changing the AF Frame Mode

▶ Still Images ▶ Movies

Change the AF (auto focus) frame mode to suit the shooting conditions as follows.

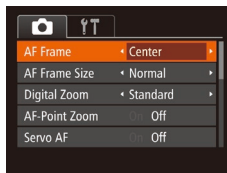

- Press the [MENU] button, choose [AF Frame] on the [📷] tab, and then choose the desired option (📖25).

Center

▶ Still Images ▶ Movies

One AF frame is displayed in the center. Effective for reliable focusing.



- A yellow AF frame is displayed with [📷] if the camera cannot focus when you press the shutter button halfway.



- To reduce the AF frame size, press the [MENU] button and set [AF Frame Size] on the [📷] tab to [Small] (📖25).
- The AF frame size is set to [Normal] when you use the digital zoom (📖33) or digital tele-converter (📖55).
- To compose shots so that subjects are positioned at the edge or in a corner, first aim the camera to capture the subject in an AF frame, and then hold the shutter button halfway down. As you continue to hold the shutter button halfway, recompose the shot as desired, and then press the shutter button all the way down (Focus Lock).
- The AF frame position is enlarged when you press the shutter button halfway and [AF-Point Zoom] (📖38) is set to [On].

Before Use

Basic Guide

Advanced Guide

1 Camera Basics

2 Auto Mode

3 Other Shooting Modes

4 P Mode

5 Playback Mode

6 Setting Menu

7 Accessories

8 Appendix

Index



Face AiAF

▶ Still Images ▶ Movies

- Detects people's faces, and then sets the focus, exposure (evaluative metering only), and white balance (AWB only).
- After you aim the camera at the subject, a white frame is displayed around the person's face determined by the camera to be the main subject, and up to two gray frames are displayed around other detected faces.
- When the camera detects movement, frames will follow moving subjects, within a certain range.
- After you press the shutter button halfway, up to nine green frames are displayed around faces in focus.



- If faces are not detected, or when only gray frames are displayed (without a white frame), up to nine green frames are displayed in the areas in focus when you press the shutter button halfway.
- If faces are not detected when Servo AF (57) is set to [On], the AF frame is displayed in the center of the screen when you press the shutter button halfway.
- Examples of faces that cannot be detected:
 - Subjects that are distant or extremely close
 - Subjects that are dark or light
 - Faces in profile, at an angle, or partly hidden
- The camera may misinterpret non-human subjects as faces.
- No AF frames are displayed if the camera cannot focus when you press the shutter button halfway.

Choosing Subjects to Focus On (Tracking AF)

▶ Still Images ▶ Movies

Shoot after choosing a subject to focus on as follows.

1 Choose [Tracking AF].

- Follow the steps in “Changing the AF Frame Mode” (55) to choose [Tracking AF].
- [AF-ON] is displayed in the center of the screen.

2 Choose a subject to focus on.

- Aim the camera so that [AF-ON] is on the desired subject, and then press the [AF-ON] button.



- When the subject is detected, the camera beeps and [AF-ON] is displayed. Even if the subject moves, the camera will continue to track the subject within a certain range.
- If no subject is detected, [AF-ON] is displayed.
- To cancel tracking, press the [AF-ON] button again.

3 Shoot.

- Press the shutter button halfway. [AF-ON] changes to a blue square, which follows the subject as the camera continues to adjust the focus and exposure (Servo AF) (57).
- Press the shutter button all the way down to shoot.
- Even after your shot, [AF-ON] is still displayed and the camera continues to track the subject.

Before Use

Basic Guide

Advanced Guide

1 Camera Basics

2 Auto Mode

3 Other Shooting Modes

4 P Mode

5 Playback Mode

6 Setting Menu

7 Accessories

8 Appendix

Index

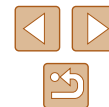



- [Servo AF] (📖57) is set to [On] and cannot be changed.
- Tracking may not be possible when subjects are too small or move too rapidly, or when subject color or brightness matches that of the background too closely.
- [AF-Point Zoom] on the [📷] tab (📖25) is not available.
- [👤] and [🏠] are not available.



- The camera can detect subjects even if you press the shutter button halfway without pressing the [🔍] button. After your shot, [📷] is displayed in the center of the screen.

Shooting with Servo AF

▶ Still Images ▶ Movies

This mode helps avoid missing shots of subjects in motion, because the camera continues to focus on the subject and adjust the exposure as long as you press the shutter button halfway.

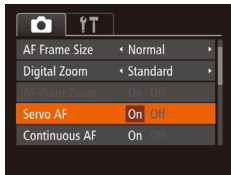

1 Configure the setting.

- Press the [MENU] button, choose [Servo AF] on the [📷] tab, and then choose [On] (📖25).

2 Focus.

- The focus and exposure are maintained where the blue AF frame is displayed while you are pressing the shutter button halfway.



- Focusing may not be possible in some shooting conditions.
- In low-light conditions, Servo AF may not be activated (AF frames may not turn blue) when you press the shutter button halfway. In this case, the focus and exposure are set according to the specified AF frame mode.
- If adequate exposure cannot be obtained, shutter speeds and aperture values are displayed in orange. Release the shutter button, and then press it halfway again.
- AF lock shooting is not available.
- [AF-Point Zoom] on the [📷] tab (📖25) is not available.
- Not available when using the self-timer (📖33).

Changing the Focus Setting

▶ Still Images ▶ Movies

You can change default camera operation of constantly focusing on subjects it is aimed at, even when the shutter button is not pressed. Instead, you can limit camera focusing to the moment you press the shutter button halfway.

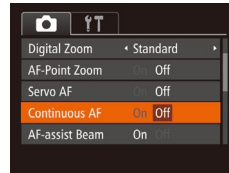

- Press the [MENU] button, choose [Continuous AF] on the [📷] tab, and then choose [On] (📖25).

On	Helps avoid missing sudden photo opportunities, because the camera constantly focuses on subjects until you press the shutter button halfway.
Off	Conserves battery power, because the camera does not focus constantly.

Before Use

Basic Guide

Advanced Guide

1 Camera Basics

2 Auto Mode

3 Other Shooting Modes

4 P Mode

5 Playback Mode

6 Setting Menu

7 Accessories

8 Appendix

Index

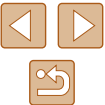

Shooting with the AF Lock

► Still Images ► Movies

The focus can be locked. After you lock the focus, the focal position will not change even when you release your finger from the shutter button.

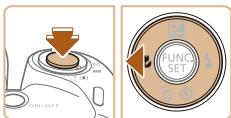

1 Lock the focus.

- With the shutter button pressed halfway, press the [L] button.
- The focus is now locked, and [AF-L] is displayed.
- To unlock the focus, release the shutter button and press the [L] button again. In this case, [AF-L] is no longer displayed.

2 Compose the shot and shoot.

Flash

Changing the Flash Mode

► Still Images ► Movies

You can change the flash mode to match the shooting scene. For details on the flash range, see “Flash Range” (114).

1 Lift the flash.

2 Configure the setting.

- Press the [R] button, press the [L][R] buttons to choose a flash mode, and then press the [OK] button.
- The option you configured is now displayed.

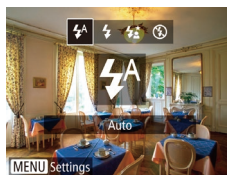

- The setting screen cannot be accessed by pressing the [R] button when the flash is lowered. Lift the flash with your finger in advance.

Auto

Fires automatically in low-light conditions.

On

Fires for each shot.

Slow Synchro

Fires to illuminate the main subject (such as people) while shooting at a slower shutter speed to illuminate backgrounds out of flash range.

Before Use

Basic Guide

Advanced Guide

1 Camera Basics

2 Auto Mode

3 Other Shooting Modes

4 P Mode

5 Playback Mode

6 Setting Menu

7 Accessories

8 Appendix

Index





- In [Fn] mode, mount the camera on a tripod or take other measures to keep it still and prevent camera shake. Additionally, you should set [IS Mode] to [Off] when using a tripod or other means to secure the camera (1160).
- In [Fn] mode, even after the flash fires, ensure that the main subject does not move until the shutter sound is finished playing.

Off

For shooting without the flash.



- If a blinking [Fn] icon is displayed when you press the shutter button halfway in camera-shake inducing, low-light conditions, mount the camera on a tripod or take other measures to keep it still.

Shooting with the FE Lock

► Still Images ► Movies

Just as with the AE lock (1150), you can lock the exposure for the flash shots.

1 Lift the flash and set the flash to [Fn] (1158).

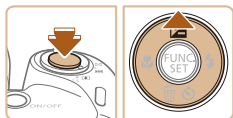

2 Lock the flash exposure.

- Aim the camera at the subject to shoot with the exposure locked. With the shutter button pressed halfway, press the [▲] button.
- The flash fires, and when [FE] is displayed, the flash output level is retained.
- To unlock FE, release the shutter button and press the [▲] button again. In this case, [FE] is no longer displayed.

3 Compose the shot and shoot.



- FE: Flash Exposure

Other Settings

Changing the Compression Ratio (Image Quality)

► Still Images ► Movies

Choose from two compression ratios, [SF] (Super Fine) and [F] (Fine), as follows. For guidelines on how many shots at each compression ratio can fit on a memory card, see “Number of Shots per Memory Card” (1114).



- Press the [Q] button, choose [F] in the menu, and choose the desired option (1124).

Before Use

Basic Guide

Advanced Guide

1 Camera Basics

2 Auto Mode

3 Other Shooting Modes

4 P Mode

5 Playback Mode

6 Setting Menu

7 Accessories

8 Appendix

Index



Changing the IS Mode Settings

▶ Still Images ▶ Movies

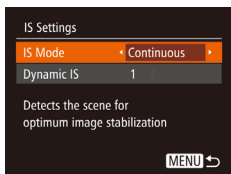

1 Access the setting screen.

- Press the [MENU] button, choose [IS Settings] on the [CAMERA] tab, and then press the [INFO] button (p.25).

2 Configure the setting.

- Choose [IS Mode], and then choose the desired option (p.25).

Continuous	Optimal image stabilization for the shooting conditions is automatically applied (Intelligent IS) (p.32).
Shoot Only*	Image stabilization is active only at the moment of shooting.
Off	Deactivates image stabilization.

* The setting is changed to [Continuous] for movie recording.



- If image stabilization cannot prevent camera shake, mount the camera on a tripod or take other measures to hold it still. In this case, set [IS Mode] to [Off].

Shooting Movies with Subjects at the Same Size Shown before Shooting

▶ Still Images ▶ Movies

Normally, once movie recording begins, the image display area changes and subjects are enlarged to allow for correction of significant camera shake. To shoot subjects at the same size shown before shooting, you can choose not to reduce significant camera shake.

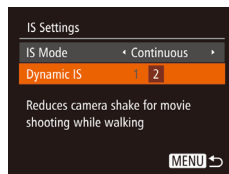

- Follow the steps in “Changing the IS Mode Settings” (p.60) to access the [IS Settings] screen.
- Choose [Dynamic IS], and then choose [2] (p.25).



- When movie image quality is set to [FVG] (p.37), the [Dynamic IS] setting is [1] and cannot be changed.
- You can also set [IS Mode] to [Off], so that subjects are recorded at the same size shown before shooting.

Before Use

Basic Guide

Advanced Guide

1 Camera Basics

2 Auto Mode

3 Other Shooting Modes

4 P Mode

5 Playback Mode

6 Setting Menu

7 Accessories

8 Appendix

Index



5

Playback Mode

Have fun reviewing your shots, and browse or edit them in many ways

- To prepare the camera for these operations, press the [▶] button to enter Playback mode.



- It may not be possible to play back or edit images that were renamed or already edited on a computer, or images from other cameras.

Viewing

▶ Still Images ▶ Movies

After shooting images or movies, you can view them on the screen as follows.



1 Enter Playback mode.

- Press the [▶] button.
- Your last shot is displayed.



2 Browse through your images.

- To view the previous image, press the [◀] button. To view the next image, press the [▶] button.

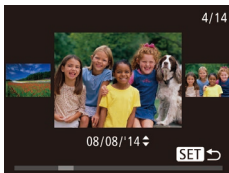

- To access this screen (Scroll Display mode), press and hold the [◀][▶] buttons for at least one second. In this mode, press the [◀][▶] buttons to browse through images.
- To return to single-image display, press the [⊞] button.
- To browse images grouped by shooting date, press the [▲][▼] buttons in Scroll Display mode.

Before Use

Basic Guide

Advanced Guide

1 Camera Basics

2 Auto Mode

3 Other Shooting Modes

4 P Mode

5 Playback Mode

6 Setting Menu

7 Accessories

8 Appendix

Index

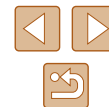



- Movies are identified by a [SET ▶] icon. To play movies, go to step 3.

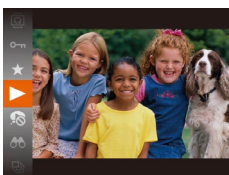

3 Play movies.

- To start playback, press the [⏪] button, press the [▲][▼] buttons to choose [▶], and then press the [⏩] button again.

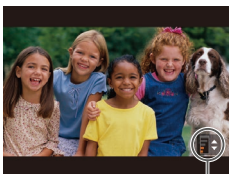

4 Adjust the volume.

- Press the [▲][▼] buttons to adjust the volume.
- To adjust the volume when the volume indicator (1) is no longer displayed, press the [▲][▼] buttons.

(1)

5 Pause playback.

- To pause or resume playback, press the [⏸] button.
- After the movie is finished, [SET ▶] is displayed.



- To switch to Shooting mode from Playback mode, press the shutter button halfway.
- To deactivate Scroll Display, choose MENU (📖25) ▶ [▶] tab ▶ [Scroll Display] ▶ [Off].
- To have the most recent shot displayed when you enter Playback mode, choose MENU (📖25) ▶ [▶] tab ▶ [Resume] ▶ [Last shot].
- To change the transition shown between images, access MENU (📖25) and choose your desired effect on the [▶] tab ▶ [Transition].

Switching Display Modes

▶ Still Images ▶ Movies

Press the [DISP] button to view other information on the screen, or to hide the information. For details on the information displayed, see “Playback (Detailed Information Display)” (📖105).

	No Information Display
	Simple Information Display
	Detailed Information Display

■ Overexposure Warning (for Image Highlights)

▶ Still Images ▶ Movies

Washed-out highlights in the image flash on the screen in detailed information display (📖62).

Before Use

Basic Guide

Advanced Guide

1 Camera Basics

2 Auto Mode

3 Other Shooting Modes

4 P Mode

5 Playback Mode

6 Setting Menu

7 Accessories

8 Appendix

Index



Histogram

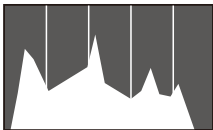

► Still Images ► Movies

- The graph in detailed information display (62) is a histogram showing the distribution of brightness in the image. The horizontal axis represents the degree of brightness, and the vertical axis, how much of the image is at each level of brightness. Viewing the histogram is a way to check exposure.

Browsing and Filtering Images



Navigating through Images in an Index

► Still Images ► Movies

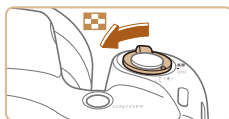
By displaying multiple images in an index, you can quickly find the images you are looking for.







1 Display images in an index.

- Move the zoom lever toward  to display images in an index. Moving the lever again will increase the number of images shown.
- To display fewer images, move the zoom lever toward . Fewer images are shown each time you move the lever.



2 Choose an image.

- Press the  buttons to choose an image.
- An orange frame is displayed around the selected image.
- Press the  button to view the selected image in single-image display.

Before Use

Basic Guide

Advanced Guide

1 Camera Basics

2 Auto Mode

3 Other Shooting Modes

4 P Mode

5 Playback Mode

6 Setting Menu

7 Accessories

8 Appendix



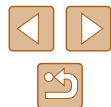

Index



Finding Images Matching Specified Conditions

► Still Images ► Movies

Find desired images quickly on a memory card full of images by filtering image display according to your specified conditions. You can also protect (667) or delete (669) these images all at once.

 People	Displays images with detected faces.
 Shot Date	Displays the images shot on a specific date.
 Favorites	Displays images tagged as favorites (72).
 Still image/Movie	Displays only still images or movies.

1 Choose a search condition.

- Press the [Ⓞ] button, choose [Ⓞ] in the menu, and choose a condition (24).
- When you have selected [☺] or [📷], choose the condition by pressing the [▲][▼][◀][▶] buttons on the screen displayed, and then press the [Ⓞ] button.

2 View the filtered images.

- Images matching your conditions are displayed in yellow frames. To view only these images, press the [◀][▶] buttons.
- To cancel filtered display, choose [🗑] in step 1.



- When the camera has found no corresponding images for some conditions, those conditions will not be available.



- To show or hide information, press the [DISP] button in step 2.
- Options for viewing the images found (in step 2) include “Navigating through Images in an Index” (63), “Magnifying Images” (65), and “Viewing Slideshows” (65). You can also apply image operations to all images found, by choosing [Protect All Images in Search] in “Protecting Images” (67) or [Select All Images in Search] in “Erasing Multiple Images at Once” (69), “Adding Images to the Print List (DPOF)” (95), or “Adding Images to a Photobook” (97).
- If you edit images and save them as new images (73 – 76), a message is displayed, and the images that were found are no longer shown.

Before Use

Basic Guide

Advanced Guide

1 Camera Basics

2 Auto Mode

3 Other Shooting Modes

4 P Mode

5 Playback Mode

6 Setting Menu

7 Accessories

8 Appendix

Index



Image Viewing Options

Magnifying Images

▶ Still Images ▶ Movies

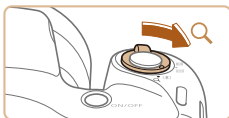

(1)

1 Magnify an image.

- Moving the zoom lever toward [Q] will zoom in and magnify the image, and [SET] is displayed. You can magnify images up to about 10x by continuing to hold the zoom lever.
- The approximate position of the displayed area (1) is shown for reference.
- To zoom out, move the zoom lever toward [Q]. You can return to single-image display by continuing to hold it.

2 Move the display position and switch images as needed.

- To move the display position, press the [▲][▼][◀][▶] buttons.
- While [SET] is displayed, you can switch to [SET] by pressing the [DISP] button. To switch to other images while zoomed, press the [◀][▶] buttons. Press the [DISP] button again to restore the original setting.



- You can return to single-image display from magnified display by pressing the [MENU] button.

Viewing Slideshows

▶ Still Images ▶ Movies

Automatically play back images from a memory card as follows. Each image is displayed for about three seconds.



- Press the [DISP] button, choose [LoF] in the menu, and choose the desired option (p.24).
- The slideshow will start after [Loading image] is displayed for a few seconds.
- Press the [MENU] button to stop the slideshow.



- The camera's power-saving functions (p.23) are deactivated during slideshows.



- To pause or resume slideshows, press the [DISP] button.
- You can switch to other images during playback by pressing the [◀][▶] buttons. For fast-forward or fast-rewind, hold the [◀][▶] buttons down.
- In filtered display (p.64), only images matching search conditions are played.

Before Use

Basic Guide

Advanced Guide

1 Camera Basics

2 Auto Mode

3 Other Shooting Modes

4 P Mode

5 Playback Mode

6 Setting Menu

7 Accessories

8 Appendix

Index



Changing Slideshow Settings

You can set up slideshows to repeat, and you can change the transitions between images and the display duration of each image.

1 Access the setting screen.

- Press the [MENU] button, and then choose [Slideshow] on the [▶] tab (📖25).



2 Configure the settings.

- Choose a menu item to configure, and then choose the desired option (📖25).
- To start the slideshow with your settings, choose [Start] and press the [⏪] button.
- To return to the menu screen, press the [MENU] button.



- [Play Time] cannot be modified when [Bubble] is chosen in [Effect].

Auto Playback of Related Images (Smart Shuffle)

▶ Still Images ▶ Movies

Based on the current image, the camera offers four images that you may wish to view. After you choose to view one of those images, the camera offers four more images. This is an enjoyable way to play back images in an unexpected order. Try this feature after you have taken many shots, in many kinds of scenes.

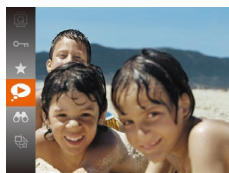

1 Choose Smart Shuffle.

- Press the [⏪] button, and then choose [▶] in the menu (📖24).
- Four candidate images are displayed.



2 Choose an image.

- Press the [▲][▼][◀][▶] buttons to choose the image you want to view next.
- Your chosen image is displayed in the center, surrounded by the next four candidate images.
- For full-screen display of the center image, press the [⏪] button. To restore the original display, press the [⏪] button again.
- Press the [MENU] button to restore single-image display.



- Smart Shuffle is not available in the following cases:
 - There are less than 50 shots taken with this camera
 - An unsupported image is currently displayed
 - Images are shown in filtered display (📖64)

Before Use

Basic Guide

Advanced Guide

1 Camera Basics

2 Auto Mode

3 Other Shooting Modes

4 P Mode

5 Playback Mode

6 Setting Menu

7 Accessories

8 Appendix

Index



Protecting Images

► Still Images ► Movies

Protect important images to prevent accidental erasure by the camera (69).



- Press the [P] button, and then choose [Protect] in the menu (24). [Protected] is displayed.
- To cancel protection, repeat this process and choose [Protect] again, and then press the [P] button.



- Protected images on a memory card will be erased if you format the card (80, 81).



- Protected images cannot be erased using the camera's erasure function. To erase them this way, first cancel protection.

Using the Menu

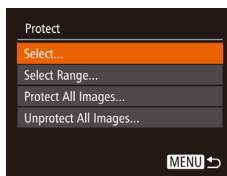
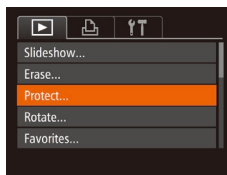

1 Access the setting screen.

- Press the [MENU] button and choose [Protect] on the [P] tab (25).

2 Choose a selection method.

- Choose a menu item and an option as desired (25).
- To return to the menu screen, press the [MENU] button.

Choosing Images Individually



1 Choose [Select].

- Following step 2 in "Using the Menu" (67), choose [Select] and press the [P] button.

2 Choose an image.

- Press the [Left] [Right] buttons to choose an image, and then press the [P] button. [Protect] is displayed.
- To cancel selection, press the [P] button again. [Protect] is no longer displayed.
- Repeat this process to specify other images.

Before Use

Basic Guide

Advanced Guide

1 Camera Basics

2 Auto Mode

3 Other Shooting Modes

4 P Mode

5 Playback Mode

6 Setting Menu

7 Accessories

8 Appendix

Index



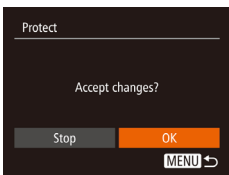

3 Protect the image.

- Press the [MENU] button. A confirmation message is displayed.
- Press the [◀][▶] buttons to choose [OK], and then press the [Ⓜ] button.



- Images will not be protected if you switch to Shooting mode or turn the camera off before finishing the setup process in step 3.

Selecting a Range

1 Choose [Select Range].

- Following step 2 in “Using the Menu” (p.67), choose [Select Range] and press the [Ⓜ] button.

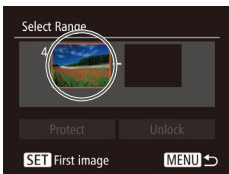

2 Choose a starting image.

- Press the [Ⓜ] button.



- Press the [◀][▶] buttons to choose an image, and then press the [Ⓜ] button.

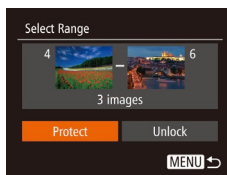
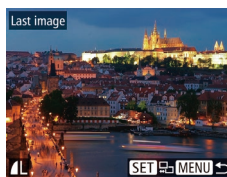
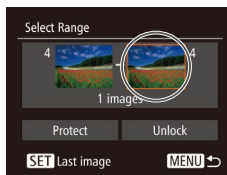

3 Choose an ending image.

- Press the [▶] button to choose [Last image], and then press the [Ⓜ] button.

- Press the [◀][▶] buttons to choose an image, and then press the [Ⓜ] button.
- Images before the first image cannot be selected as the last image.

4 Protect the images.

- Press the [▼] button to choose [Protect], and then press the [Ⓜ] button.



- To cancel protection for groups of images, choose [Unlock] in step 4.

Before Use

Basic Guide

Advanced Guide

1 Camera Basics

2 Auto Mode

3 Other Shooting Modes

4 P Mode

5 Playback Mode

6 Setting Menu

7 Accessories

8 Appendix

Index



Protecting All Images at Once

1 Choose [Protect All Images].

- Following step 2 in “Using the Menu” (📖67), choose [Protect All Images] and press the [MENU] button.

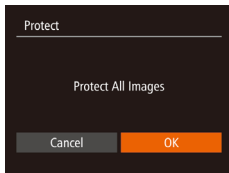

2 Protect the images.

- Press the [◀][▶] buttons to choose [OK], and then press the [MENU] button.

Clearing All Protection at Once

You can clear protection from all images at once. To clear protection, choose [Unprotect All Images] in step 1 of “Protecting All Images at Once”, and then complete step 2.

Erasing Images

► Still Images ► Movies

You can choose and erase unneeded images one by one. Be careful when erasing images, because they cannot be recovered. However, protected images (📖67) cannot be erased.

1 Choose an image to erase.

- Press the [◀][▶] buttons to choose an image.

2 Erase the image.

- Press the [▼] button.
- After [Erase?] is displayed, press the [◀][▶] buttons to choose [Erase], and then press the [MENU] button.
- The current image is now erased.
- To cancel erasure, press the [◀][▶] buttons to choose [Cancel], and then press the [MENU] button.



Erasing Multiple Images at Once

You can choose multiple images to erase at once. Be careful when erasing images, because they cannot be recovered. However, protected images (📖67) cannot be erased.

Choosing a Selection Method

1 Access the setting screen.

- Press the [MENU] button, and then choose [Erase] on the [▶] tab (📖25).



Before Use

Basic Guide

Advanced Guide

1 Camera Basics

2 Auto Mode

3 Other Shooting Modes

4 P Mode

5 Playback Mode

6 Setting Menu

7 Accessories

8 Appendix

Index

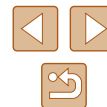

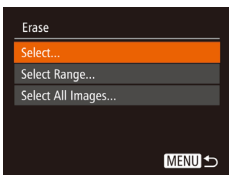

2 Choose a selection method.

- Press the [▲][▼] buttons to choose a selection method, and then press the [Ⓢ] button.
- To return to the menu screen, press the [MENU] button.

Choosing Images Individually

1 Choose [Select].

- Following step 2 in “Choosing a Selection Method” (📖69), choose [Select] and press the [Ⓢ] button.



2 Choose an image.

- Once you choose an image following step 2 in “Choosing Images Individually” (📖67), [✓] is displayed.
- To cancel selection, press the [Ⓢ] button again. [✓] is no longer displayed.
- Repeat this process to specify other images.

3 Erase the image.

- Press the [MENU] button. A confirmation message is displayed.
- Press the [◀][▶] buttons to choose [OK], and then press the [Ⓢ] button.

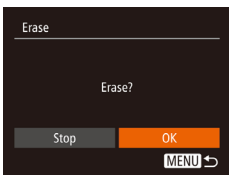

Selecting a Range

1 Choose [Select Range].

- Following step 2 in “Choosing a Selection Method” (📖69), choose [Select Range] and press the [Ⓢ] button.

2 Choose images.

- Follow steps 2 – 3 in “Selecting a Range” (📖68) to specify images.

3 Erase the images.

- Press the [▼] button to choose [Erase], and then press the [Ⓢ] button.

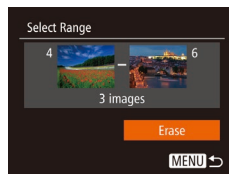

Specifying All Images at Once

1 Choose [Select All Images].

- Following step 2 in “Choosing a Selection Method” (📖69), choose [Select All Images] and press the [Ⓢ] button.

2 Erase the images.

- Press the [◀][▶] buttons to choose [OK], and then press the [Ⓢ] button.

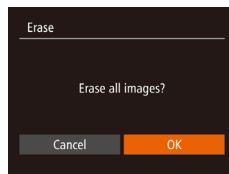

Before Use

Basic Guide

Advanced Guide

1 Camera Basics

2 Auto Mode

3 Other Shooting Modes

4 P Mode

5 Playback Mode

6 Setting Menu

7 Accessories

8 Appendix

Index



Rotating Images

► Still Images ► Movies

Change the orientation of images and save them as follows.

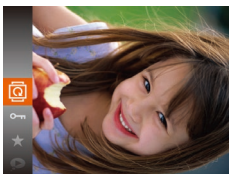

1 Choose [Rotate].

- Press the [MENU] button, and then choose [Rotate] in the menu (📖24).



2 Rotate the image.

- Press the [◀] or [▶] button, depending on the desired direction. Each time you press the button, the image is rotated 90°. Press the [MENU] button to complete the setting.

Using the Menu

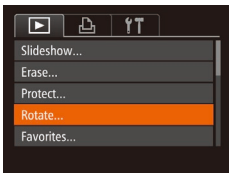

1 Choose [Rotate].

- Press the [MENU] button and choose [Rotate] on the [▶] tab (📖25).

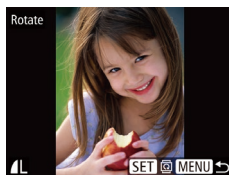

2 Rotate the image.

- Press the [◀] or [▶] buttons to choose an image.
- The image is rotated 90° each time you press the [MENU] button.
- To return to the menu screen, press the [MENU] button.



- Rotation is not possible when [Auto Rotate] is set to [Off] (📖71).

Deactivating Auto Rotation

Follow these steps to deactivate automatic image rotation, which rotates images based on the current camera orientation.

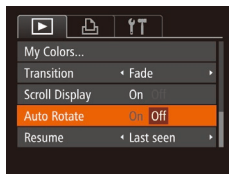

- Press the [MENU] button, choose [Auto Rotate] on the [▶] tab, and then choose [Off] (📖25).



- Images cannot be rotated (📖71) when you set [Auto Rotate] to [Off]. Additionally, images already rotated will be displayed in the original orientation.
- In Smart Shuffle (📖66) mode, even if [Auto Rotate] is set to [Off], images shot vertically will be displayed vertically, and rotated images will be displayed in the rotated orientation.

Before Use

Basic Guide

Advanced Guide

1 Camera Basics

2 Auto Mode

3 Other Shooting Modes

4 P Mode

5 Playback Mode

6 Setting Menu

7 Accessories

8 Appendix

Index

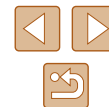

Tagging Images as Favorites

► Still Images ► Movies

You can organize images by tagging them as favorites. By choosing a category in filtered playback, you can restrict the following operations to all of those images.

- “Viewing” (61), “Viewing Slideshows” (65), “Protecting Images” (67), “Erasing Images” (69), “Adding Images to the Print List (DPOF)” (95), “Adding Images to a Photobook” (97)



- Press the [OK] button, and then choose [★] in the menu (24).
- [Tagged as Favorite] is displayed.
- To untag the image, repeat this process and choose [★] again, and then press the [OK] button.

Using the Menu

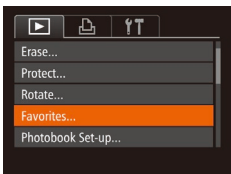

1 Choose [Favorites].

- Press the [MENU] button and choose [Favorites] on the [P] tab (25).

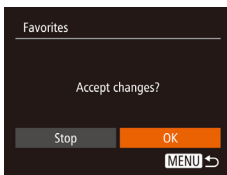

2 Choose an image.

- Press the [◀][▶] buttons to choose an image, and then press the [OK] button. [★] is displayed.
- To untag the image, press the [OK] button again. [★] is no longer displayed.
- Repeat this process to choose additional images.

3 Finish the setup process.

- Press the [MENU] button. A confirmation message is displayed.
- Press the [◀][▶] buttons to choose [OK], and then press the [OK] button.



- Images will not be tagged as favorites if you switch to Shooting mode or turn the camera off before finishing the setup process in step 3.



- Favorite images will have a three-star rating (★★★☆☆) when transferred to computers running Windows 8 or Windows 7. (Does not apply to movies.)

Before Use

Basic Guide

Advanced Guide

1 Camera Basics

2 Auto Mode

3 Other Shooting Modes

4 P Mode

5 Playback Mode

6 Setting Menu

7 Accessories

8 Appendix

Index

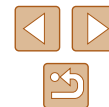

Editing Still Images



- Image editing (73 – 75) is only available when the memory card has sufficient free space.

Resizing Images

► Still Images ► Movies

Save a copy of images at a lower resolution.

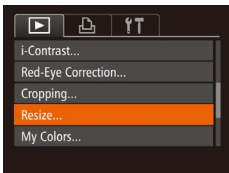

1 Choose [Resize].

- Press the [MENU] button and choose [Resize] on the [▶] tab (25).

2 Choose an image.

- Press the [◀][▶] buttons to choose an image, and then press the [OK] button.

3 Choose an image size.

- Press the [◀][▶] buttons to choose the size, and then press the [OK] button.
- [Save new image?] is displayed.



4 Save the new image.

- Press the [◀][▶] buttons to choose [OK], and then press the [OK] button.
- The image is now saved as a new file.

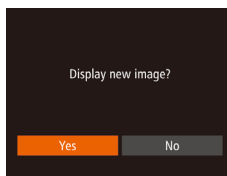
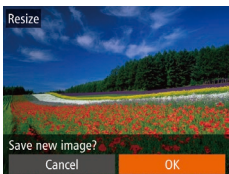

5 Review the new image.

- Press the [MENU] button. [Display new image?] is displayed.
- Press the [◀][▶] buttons to choose [Yes], and then press the [OK] button.
- The saved image is now displayed.



- Editing is not possible for images shot at a resolution of [S] (37).



- Images cannot be resized to a higher resolution.

Cropping

► Still Images ► Movies

You can specify a portion of an image to save as a separate image file.

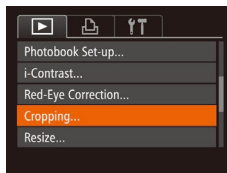

1 Choose [Cropping].

- Press the [MENU] button, and then choose [Cropping] on the [▶] tab (25).

2 Choose an image.

- Press the [◀][▶] buttons to choose an image, and then press the [OK] button.

Before Use

Basic Guide

Advanced Guide

1 Camera Basics

2 Auto Mode

3 Other Shooting Modes

4 P Mode

5 Playback Mode

6 Setting Menu

7 Accessories

8 Appendix

Index

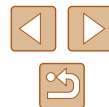

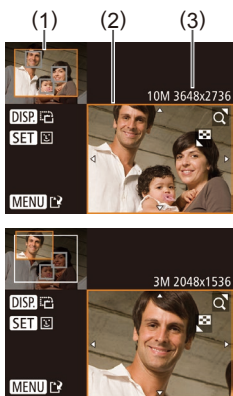

3 Adjust the cropping area.

- A frame is displayed around the portion of the image to be cropped (1).
- The original image is shown in the upper left, and a preview of the image as cropped (2) is shown in the lower right. You can also see the resolution after cropping (3).
- To resize the frame, move the zoom lever.
- To move the frame, press the [▲][▼][◀][▶] buttons.
- To change the frame orientation, press the [DISP] button.
- Faces detected in the image are enclosed in gray frames in the upper-left image. To crop the image based on this frame, press the [FACE] button to switch to the other frame.
- Press the [MENU] button.

4 Save as a new image and review.

- Follow steps 4 – 5 in “Resizing Images” (73).



- Editing is not possible for images shot at a resolution of [S] (37) or resized to [S] (73).



- Images supported for cropping will have the same aspect ratio after cropping.
- Cropped images will have a lower resolution than uncropped images.

Changing Image Color Tones (My Colors)

▶ Still Images ▶ Movies

You can adjust image colors and then save the edited image as a separate file. For details on each option, see “Changing Image Color Tones (My Colors)” (53).

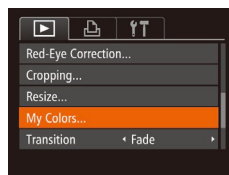

1 Choose [My Colors].

- Press the [MENU] button, and then choose [My Colors] on the [▶] tab (25).

2 Choose an image.

- Press the [◀][▶] buttons to choose an image, and then press the [OK] button.

3 Choose an option.

- Press the [◀][▶] buttons to choose an option, and then press the [OK] button.

4 Save as a new image and review.

- Follow steps 4 – 5 in “Resizing Images” (73).



- Image quality of pictures you repeatedly edit this way will be a little lower each time, and you may not be able to obtain the desired color.



- The color of images edited using this function may vary slightly from the color of images shot using My Colors (53).

Before Use

Basic Guide

Advanced Guide

1 Camera Basics

2 Auto Mode

3 Other Shooting Modes

4 P Mode

5 Playback Mode

6 Setting Menu

7 Accessories

8 Appendix

Index



Correcting Image Brightness (i-Contrast)

► Still Images ► Movies

Excessively dark image areas (such as faces or backgrounds) can be detected and automatically adjusted to the optimal brightness. Insufficient overall image contrast is also automatically corrected, to make subjects stand out better. Choose from four correction levels, and then save the image as a separate file.

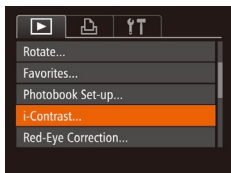

1 Choose [i-Contrast].

- Press the [MENU] button, and then choose [i-Contrast] on the [] tab (📖25).

2 Choose an image.

- Press the [◀][▶] buttons to choose an image, and then press the [] button.

3 Choose an option.

- Press the [◀][▶] buttons to choose an option, and then press the [] button.

4 Save as a new image and review.

- Follow steps 4 – 5 in “Resizing Images” (📖73).



- For some images, correction may be inaccurate or may cause images to appear grainy.
- Images may look grainy after repeated editing using this function.



- If [Auto] does not produce the expected results, try correcting images using [Low], [Medium], or [High].

Correcting Red-Eye

► Still Images ► Movies

Automatically corrects images affected by red-eye. You can save the corrected image as a separate file.

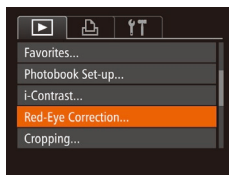

1 Choose [Red-Eye Correction].

- Press the [MENU] button, and then choose [Red-Eye Correction] on the [] tab (📖25).

2 Choose an image.

- Press the [◀][▶] buttons to choose an image.

3 Correct the image.

- Press the [] button.
- Red-eye detected by the camera is now corrected, and frames are displayed around corrected image areas.
- Enlarge or reduce images as needed. Follow the steps in “Magnifying Images” (📖65).



4 Save as a new image and review.

- Press the [▲][▼][◀][▶] buttons to choose [New File], and then press the [] button.
- The image is now saved as a new file.
- Follow step 5 in “Resizing Images” (📖73).



- Some images may not be corrected accurately.
- To overwrite the original image with the corrected image, choose [Overwrite] in step 4. In this case, the original image will be erased.
- Protected images cannot be overwritten.

Before Use

Basic Guide

Advanced Guide

1 Camera Basics

2 Auto Mode

3 Other Shooting Modes

4 P Mode

5 Playback Mode

6 Setting Menu

7 Accessories

8 Appendix

Index



Editing Movies

► Still Images ► Movies

You can cut movies to remove unneeded portions at the beginning or end.

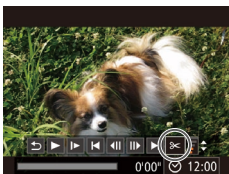

1 Choose [F7].

- Following steps 1 – 5 in “Viewing” (861), choose [F7] and press the [OK] button.
- The movie editing panel and editing bar are now displayed.



2 Specify portions to cut.

- (1) is the movie editing panel, and (2) is the editing bar.
- Press the [▲][▼] buttons to choose [L] or [R].
- To view the portions you can cut (identified by [L] on the screen), press the [◀][▶] buttons to move [L]. Cut the beginning of the movie (from [L]) by choosing [L], and cut the end of the movie by choosing [R].
- If you move [L] to a position other than a [L] mark, in [L] the portion before the nearest [L] mark on the left will be cut, while in [R] the portion after the nearest [L] mark on the right will be cut.

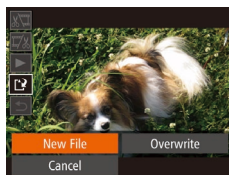

3 Review the edited movie.

- Press the [▲][▼] buttons to choose [▶], and then press the [OK] button. The edited movie is now played.
- To edit the movie again, repeat step 2.
- To cancel editing, press the [▲][▼] buttons to choose [L]. Press the [OK] button, press the [◀][▶] buttons to choose [OK], and then press the [OK] button again.

4 Save the edited movie.

- Press the [▲][▼] buttons to choose [L], and then press the [OK] button.
- Press the [▲][▼][◀][▶] buttons to choose [New File], and then press the [OK] button.
- The movie is now saved as a new file.



- To overwrite the original movie with the cut one, choose [Overwrite] in step 4. In this case, the original movie will be erased.
- If the memory card lacks sufficient space, only [Overwrite] will be available.
- Movies may not be saved if the battery pack runs out while saving is in progress.
- When editing movies, you should use a fully charged battery pack or an AC adapter kit (sold separately, 85).

Before Use

Basic Guide

Advanced Guide

1 Camera Basics

2 Auto Mode

3 Other Shooting Modes

4 P Mode

5 Playback Mode

6 Setting Menu

7 Accessories

8 Appendix

Index



6

Setting Menu

Customize or adjust basic camera functions for greater convenience

Adjusting Basic Camera Functions

MENU (📖25) functions on the (↑↓) tab can be configured. Customize commonly used functions as desired, for greater convenience.

Silencing Camera Operations

Silence camera sounds and movies as follows.

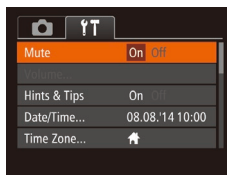

- Choose [Mute], and then choose [On].



- Operation can also be silenced by holding down the [DISP] button as you turn the camera on.
- Sound is not played during movies (📖61) if you mute camera sounds. To restore sound during movies, press the [▲] button. Adjust volume with the [▲][▼] buttons, as needed.

Adjusting the Volume

Adjust the volume of individual camera sounds as follows.

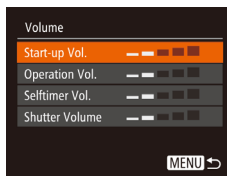

- Choose [Volume], and then press the (🔊) button.
- Choose an item, and then press the [◀][▶] buttons to adjust the volume.

Before Use

Basic Guide

Advanced Guide

1 Camera Basics

2 Auto Mode

3 Other Shooting Modes

4 P Mode

5 Playback Mode

6 Setting Menu

7 Accessories

8 Appendix

Index

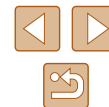

Hiding Hints and Tips

Hints and tips are normally shown when you choose FUNC. (📖24) or MENU (📖25) items. If you prefer, you can deactivate this information.

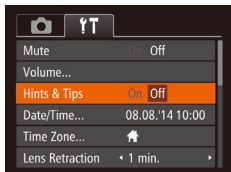

- Choose [Hints & Tips], and then choose [Off].

Date and Time

Adjust the date and time as follows.

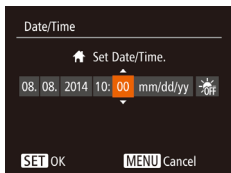

- Choose [Date/Time], and then press the [ⓘ] button.
- Press the [◀][▶] buttons to choose an option, and then press the [▲][▼] buttons to adjust the setting.

World Clock

To ensure that your shots will have the correct local date and time when you travel abroad, simply register the destination in advance and switch to that time zone. This convenient feature eliminates the need to change the Date/Time setting manually.

Before using the world clock, be sure to set the date and time and your home time zone, as described in “Setting the Date and Time” (📖17).

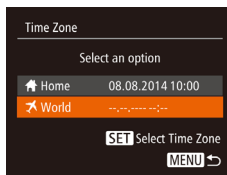

1 Specify your destination.

- Choose [Time Zone], and then press the [ⓘ] button.
- Press the [▲][▼] buttons to choose [✈ World], and then press the [ⓘ] button.
- Press the [◀][▶] buttons to choose the destination.
- To set daylight saving time (1 hour ahead), choose [☀] by pressing the [▲][▼] buttons, and then choose [☀] by pressing the [◀][▶] buttons.
- Press the [ⓘ] button.

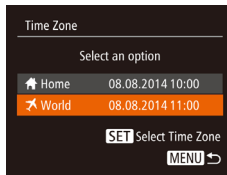

2 Switch to the destination time zone.

- Press the [▲][▼] buttons to choose [✈ World], and then press the [MENU] button.
- [✈] is now shown on the shooting screen (📖104).



- Adjusting the date or time while in [✈] mode (📖17) will automatically update your [🏠 Home] time and date.

Before Use

Basic Guide

Advanced Guide

1 Camera Basics

2 Auto Mode

3 Other Shooting Modes

4 P Mode

5 Playback Mode

6 Setting Menu

7 Accessories

8 Appendix

Index

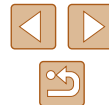

Lens Retraction Timing

The lens is normally retracted for safety about one minute after you press the [▶] button in Shooting mode (122). To have the lens retracted immediately after you press the [▶] button, set the retraction timing to [0 sec.].

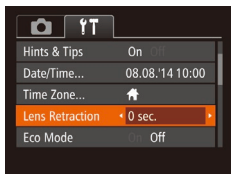

- Choose [Lens Retraction], and then choose [0 sec.].

Using Eco Mode

This function allows you to conserve battery power in Shooting mode. When the camera is not in use, the screen quickly darkens to reduce battery consumption.

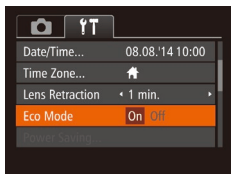

1 Configure the setting.

- Choose [Eco Mode], and then choose [On].
- [ECO] is now shown on the shooting screen (104).
- The screen darkens when the camera is not used for approximately two seconds; approximately ten seconds after darkening, the screen turns off. The camera turns off after approximately three minutes of inactivity.

2 Shoot.

- To activate the screen and prepare for shooting when the screen is off but the lens is still out, press the shutter button halfway.

Power-Saving Adjustment

Adjust the timing of automatic camera and screen deactivation (Auto Power Down and Display Off, respectively) as needed (123).

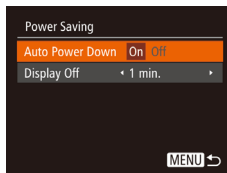

- Choose [Power Saving], and then press the [P] button.
- After choosing an item, press the [◀][▶] buttons to adjust it as needed.



- To conserve battery power, you should normally choose [On] for [Auto Power Down] and [1 min.] or less for [Display Off].



- The [Display Off] setting is applied even if you set [Auto Power Down] to [Off].
- These power-saving functions are not available when you have set Eco mode (179) to [On].

Before Use

Basic Guide

Advanced Guide

1 Camera Basics

2 Auto Mode

3 Other Shooting Modes

4 P Mode

5 Playback Mode

6 Setting Menu

7 Accessories

8 Appendix

Index

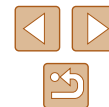

Screen Brightness

Adjust screen brightness as follows.



- Choose [LCD Brightness], and then press the [◀][▶] buttons to adjust the brightness.



- For maximum brightness, press and hold the [DISP] button for at least one second when the shooting screen is displayed or when in single-image display. (This will override the [LCD Brightness] setting on the [T] tab.) To restore the original brightness, press and hold the [DISP] button again for at least one second or restart the camera.

Hiding the Start-Up Screen

If you prefer, you can deactivate display of the start-up screen normally shown when you turn the camera on.

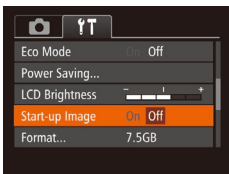

- Choose [Start-up Image], and then choose [Off].

Formatting Memory Cards

Before using a new memory card or a card formatted in another device, you should format the card with this camera.

Formatting erases all data on a memory card. Before formatting, copy images on the memory card to a computer, or take other steps to back them up.

An Eye-Fi card (E98) contains software on the card itself. Before formatting an Eye-Fi card, install the software on a computer.

1 Access the [Format] screen.

- Choose [Format], and then press the [OK] button.

2 Choose [OK].

- Press the [▲][▼] buttons to choose [Cancel], press the [◀][▶] buttons to choose [OK], and then press the [OK] button.

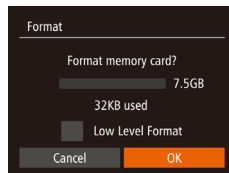

3 Format the memory card.

- To begin the formatting process, press the [▲][▼] buttons to choose [OK], and then press the [OK] button.
- When formatting is finished, [Memory card formatting complete] is displayed. Press the [OK] button.

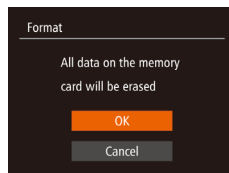

- Formatting or erasing data on a memory card only changes file management information on the card and does not erase the data completely. When transferring or disposing of memory cards, take steps to protect personal information if necessary, as by physically destroying cards.

Before Use

Basic Guide

Advanced Guide

1 Camera Basics

2 Auto Mode

3 Other Shooting Modes

4 P Mode

5 Playback Mode

6 Setting Menu

7 Accessories

8 Appendix

Index





- The total card capacity indicated on the formatting screen may be less than the advertised capacity.

Low-Level Formatting

Perform low-level formatting in the following cases: [Memory card error] is displayed, the camera is not working correctly, card image reading/writing is slower, continuous shooting is slower, or movie recording suddenly stops. Low-level formatting erases all data on a memory card. Before low-level formatting, copy images on the memory card to a computer, or take other steps to back them up.

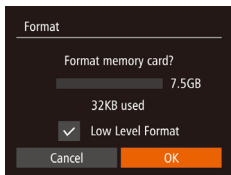

- On the screen in step 2 of “Formatting Memory Cards” (80), press the [▲][▼] buttons to choose [Low Level Format], and then press the [◀][▶] buttons to select this option. A [✓] icon is displayed.
- Follow steps 2 – 3 in “Formatting Memory Cards” (80) to continue with the formatting process.



- Low-level formatting takes longer than “Formatting Memory Cards” (80), because data is erased from all storage regions of the memory card.
- You can cancel low-level formatting in progress by choosing [Stop]. In this case, all data will be erased, but the memory card can be used normally.

File Numbering

Your shots are automatically numbered in sequential order (0001 – 9999) and saved in folders that store up to 2,000 images each. You can change how the camera assigns file numbers.

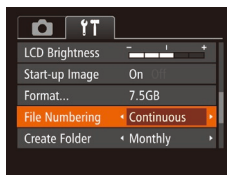

- Choose [File Numbering], and then choose an option.

Continuous	Images are numbered consecutively (until the 9999th shot is taken/saved) even if you switch memory cards.
Auto Reset	Image numbering is reset to 0001 if you switch memory cards, or when a new folder is created.



- Regardless of the option selected in this setting, shots may be numbered consecutively after the last number of existing images on newly inserted memory cards. To start saving shots from 0001, use an empty (or formatted (80)) memory card.

Before Use

Basic Guide

Advanced Guide

1 Camera Basics

2 Auto Mode

3 Other Shooting Modes

4 P Mode

5 Playback Mode

6 Setting Menu

7 Accessories

8 Appendix

Index



Date-Based Image Storage

Instead of saving images in folders created each month, you can have the camera create folders each day you shoot to store shots taken that day.

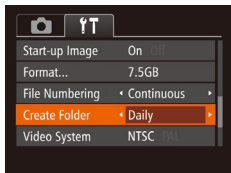

- Choose [Create Folder], and then choose [Daily].
- Images will now be saved in folders created on the shooting date.

Checking Certification Logos

Some logos for certification requirements met by the camera can be viewed on the screen. Other certification logos are printed in this guide, on the camera packaging, or on the camera body.

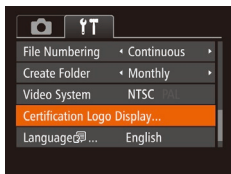

- Choose [Certification Logo Display], and then press the [MENU] button.

Display Language

Change the display language as needed.



- Choose [Language] (🗨️), and then press the [MENU] button.
- Press the [▲][▼][◀][▶] buttons to choose a language, and then press the [MENU] button.



- You can also access the [Language] screen in Playback mode by pressing and holding the [MENU] button and immediately pressing the [MENU] button.

Adjusting Other Settings

The following settings can also be adjusted on the [Y/T] tab.

- [Video System] (📖87)
- [Eye-Fi Settings] (📖98)

Before Use

Basic Guide

Advanced Guide

1 Camera Basics

2 Auto Mode

3 Other Shooting Modes

4 P Mode

5 Playback Mode

6 Setting Menu

7 Accessories

8 Appendix

Index



Restoring Defaults

If you accidentally change a setting, you can restore default camera settings.

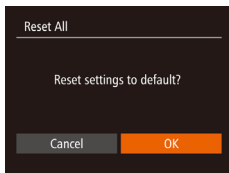

1 Access the [Reset All] screen.

- Choose [Reset All], and then press the [⏏] button.

2 Restore default settings.

- Press the [◀][▶] buttons to choose [OK], and then press the [⏏] button.
- Default settings are now restored.



- The following functions are not restored to default settings.
 - [↑↓] tab settings [Date/Time] (📖78), [Time Zone] (📖78), [Language] (📖82), and [Video System] (📖87)
 - Custom white balance data you have recorded (📖53)
 - Shooting mode (📖43)

Before Use

Basic Guide

Advanced Guide

1 Camera Basics

2 Auto Mode

3 Other Shooting Modes

4 P Mode

5 Playback Mode

6 Setting Menu

7 Accessories

8 Appendix

Index

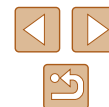

7

Accessories

Enjoy the camera in more ways with optional Canon accessories and other compatible accessories sold separately

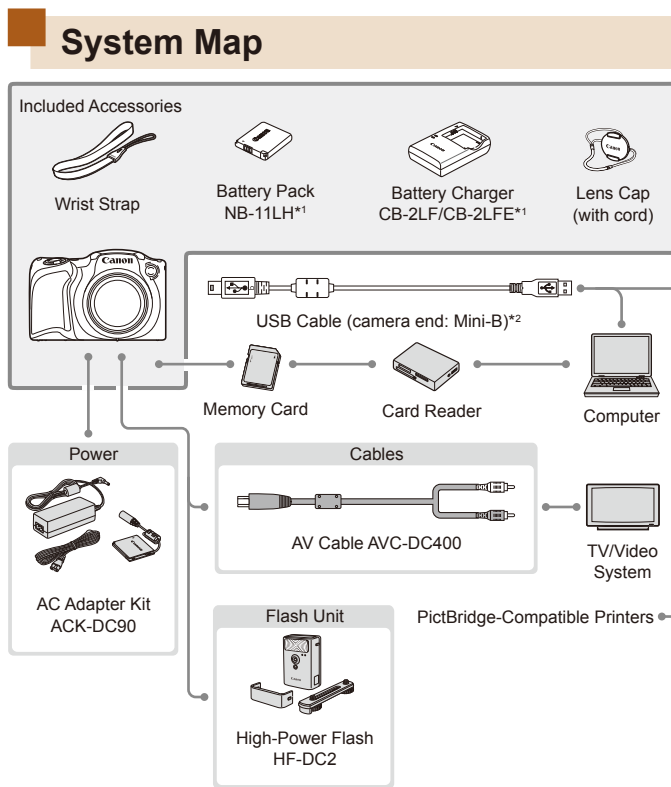

*1 Also available for purchase separately.

*2 A genuine Canon accessory is also available (Interface Cable IFC-400PCU).

Before Use

Basic Guide

Advanced Guide

1 Camera Basics

2 Auto Mode

3 Other Shooting Modes

4 P Mode

5 Playback Mode

6 Setting Menu

7 Accessories

8 Appendix

Index



Use of genuine Canon accessories is recommended.

This product is designed to achieve excellent performance when used with genuine Canon accessories. Canon shall not be liable for any damage to this product and/or accidents such as fire, etc., caused by the malfunction of non-genuine Canon accessories (e.g., a leakage and/or explosion of a battery pack). Please note that this warranty does not apply to repairs arising out of the malfunction of non-genuine Canon accessories, although you may request such repairs on a chargeable basis.

Optional Accessories

The following camera accessories are sold separately. Note that availability varies by area, and some accessories may no longer be available.

Power Supplies

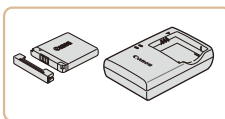

Battery Pack NB-11LH

- Rechargeable lithium-ion battery

Battery Charger CB-2LF/CB-2LFE

- Charger for Battery Pack NB-11LH



- The battery pack includes a convenient cover which you can attach to know the charge status at a glance. Attach the cover so that ▲ is visible on a charged battery pack, and attach it so that ▲ is not visible on an uncharged battery pack.
- Battery Pack NB-11L is also supported.
- Battery Charger CB-2LD and CB-2LDE are also supported.

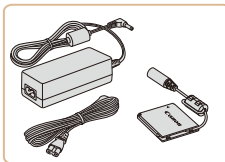

AC Adapter Kit ACK-DC90

- For powering the camera using household power. Recommended when using the camera over extended periods, or when connecting the camera to a printer or computer. Cannot be used to charge the battery pack in the camera.

Before Use

Basic Guide

Advanced Guide

1 Camera Basics

2 Auto Mode

3 Other Shooting Modes

4 P Mode

5 Playback Mode

6 Setting Menu

7 Accessories

8 Appendix

Index





- The battery charger and AC adapter kit can be used in areas with 100 – 240 V AC power (50/60 Hz).
- For power outlets in a different format, use a commercially available adapter for the plug. Never use an electrical transformer designed for traveling, which may damage the battery pack.

Flash Unit



High-Power Flash HF-DC2

- External flash for illuminating subjects that are out of range of the built-in flash.

Other Accessories

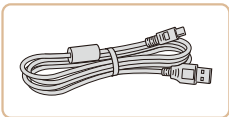

Interface Cable IFC-400PCU

- For connecting the camera to a computer or printer.

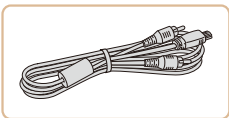

AV Cable AVC-DC400

- Connect the camera to a TV to enjoy playback on the larger TV screen.

Printer

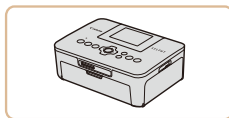

Canon-Brand PictBridge-Compatible Printers

- Even without using a computer, you can print images by connecting the camera directly to a printer. For details, visit your nearest Canon retailer.

Before Use

Basic Guide

Advanced Guide

1 Camera Basics

2 Auto Mode

3 Other Shooting Modes

4 P Mode

5 Playback Mode

6 Setting Menu

7 Accessories

8 Appendix

Index



Using Optional Accessories

▶ Still Images ▶ Movies

Playback on a TV

▶ Still Images ▶ Movies

Connecting the camera to a TV with the AV Cable AVC-DC400 (sold separately) enables you to view your shots on the larger screen of the TV as you control the camera.

For details on connection or how to switch inputs, refer to the TV manual.



- Some information may not be displayed when viewing images on a TV (105).

1 Make sure the camera and TV are off.

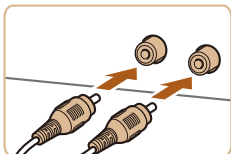

2 Connect the camera to the TV.

- On the TV, insert the cable plugs fully into the video inputs as shown.
- Make sure the cable plugs are in video inputs of the same color.
- On the camera, open the terminal cover and insert the cable plug fully into the camera terminal.

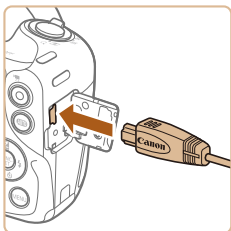

3 Turn the TV on and switch to video input.

- Switch the TV input to the video input you connected the cable to in step 2.

4 Turn the camera on.

- Press the [▶] button to turn the camera on.
- Images from the camera are now displayed on the TV. (Nothing is displayed on the camera screen.)
- When finished, turn off the camera and TV before disconnecting the cable.



- Correct display is not possible unless the camera video output format (NTSC or PAL) matches the TV format. To change the video output format, press the [MENU] button and choose [Video System] on the [↑] tab.

Powering the Camera with Household Power

▶ Still Images ▶ Movies

Powering the camera with AC Adapter Kit ACK-DC90 (sold separately) eliminates the need to monitor the remaining battery level.

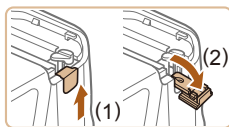

1 Make sure the camera is off.

2 Open the cover.

- Follow step 1 in “Inserting the Battery Pack and Memory Card” (16) to open the memory card/battery cover, and then open the coupler cable port cover as shown.

Before Use

Basic Guide

Advanced Guide

1 Camera Basics

2 Auto Mode

3 Other Shooting Modes

4 P Mode

5 Playback Mode

6 Setting Menu

7 Accessories

8 Appendix

Index



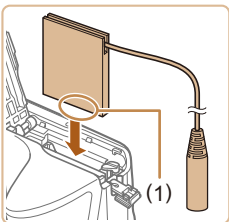

3 Insert the coupler.

- Holding the coupler with the terminals (1) facing as shown, insert the coupler just as you would a battery pack (following step 2 in “Inserting the Battery Pack and Memory Card” (p.16)).

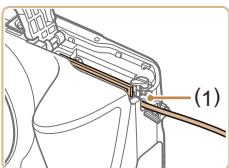

- Make sure the coupler cable passes through the port (1).

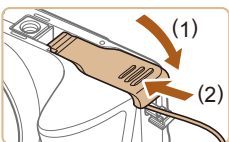

4 Close the cover.

- Lower the cover (1) and hold it down as you slide it, until it clicks into the closed position (2).

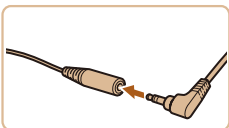

5 Connect the power cord.

- Insert the adapter plug into the end of the coupler cable.

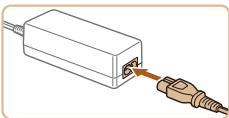

- Insert one end of the power cord into the compact power adapter, and then plug the other end into a power outlet.
- Turn the camera on and use it as desired.
- When finished, turn the camera off and unplug the power cord from the outlet.



- Do not disconnect the adapter or unplug the power cord while the camera is still on. This may erase your shots or damage the camera.
- Do not attach the adapter or adapter cord to other objects. Doing so could result in malfunction or damage to the product.

Before Use

Basic Guide

Advanced Guide

1 Camera Basics

2 Auto Mode

3 Other Shooting Modes

4 P Mode

5 Playback Mode

6 Setting Menu

7 Accessories

8 Appendix

Index



Using the Software

After downloading the software from the Canon website and installing it on the computer you are using, you can do the following things.

- CameraWindow
 - Import images and change camera settings



- When viewing or editing images on a computer, always use software that supports the images shot on the camera (software normally installed on the computer or general-use software).

Checking Your Computer Environment

The software can be used on the following computers. For detailed system requirements and compatibility information, including support in new operating systems, visit the Canon website.

Operating System	Windows	Mac OS
	Windows 8/8.1 Windows 7 SP1	Mac OS X 10.9 Mac OS X 10.8



- Check the Canon website for the latest system requirements, including supported OS versions.

Installing the Software

Windows 7 and Mac OS X 10.8 are used here for the sake of illustration.

1 Download the software.

- With a computer connected to the Internet, access <http://www.canon.com/icpd/>.
- Access the site for your country or region.
- Download the software.

2 Install the files.

- Click [Easy Installation] and follow the on-screen instructions to complete the installation process.
- Installation may take some time, depending on computer performance and the Internet connection.
- Click [Finish] or [Restart] on the screen after installation.



- Internet access is required, and any ISP account charges and access fees must be paid separately.



- Follow the steps below to uninstall (delete) the software.
 - In Windows, click in the following order: [Start] menu > [All Programs] > [Canon Utilities], and then choose the software you want to uninstall.
 - In Mac OS, click on [Applications] folder, choose the [Canon Utilities] folder, drag the folder of the software you want to uninstall to the trash, and then empty the trash.

Before Use

Basic Guide

Advanced Guide

1 Camera Basics

2 Auto Mode

3 Other Shooting Modes

4 P Mode

5 Playback Mode

6 Setting Menu

7 Accessories

8 Appendix

Index



Saving Images to a Computer

Connecting the camera to a computer with a commercial USB cable (the camera terminal is Mini-B) enables you to import your shots.

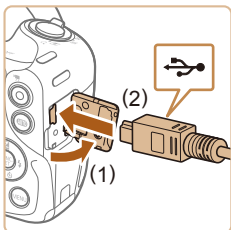

1 Connect the camera to the computer.

- With the camera turned off, open the cover (1). With the smaller plug of the USB cable in the orientation shown, insert the plug fully into the camera terminal (2).

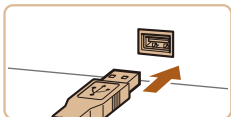



- Insert the larger plug of the USB cable in the computer's USB port. For details about USB connections on the computer, refer to the computer user manual.

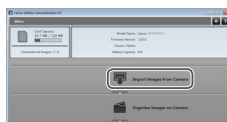
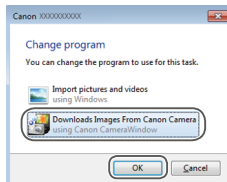

2 Turn the camera on to access CameraWindow.

- Press the [▶] button to turn the camera on.
- Mac OS: CameraWindow is displayed when a connection is established between the camera and computer.



- Windows: Follow the steps introduced below.
- In the screen that displays, click the  link to modify the program.
- Choose [Downloads Images From Canon Camera] and then click [OK].

- Double-click .

3 Save the images to the computer.

- Click [Import Images from Camera], and then click [Import Untransferred Images].
- Images are now saved to the Pictures folder on the computer, in separate folders named by date.
- After images are saved, close CameraWindow, press the [▶] button to turn the camera off, and unplug the cable.
- When viewing imported images on a computer, always use software that supports the images shot on the camera (software normally installed on the computer or general-use software).

Before Use

Basic Guide

Advanced Guide

1 Camera Basics

2 Auto Mode

3 Other Shooting Modes

4 P Mode

5 Playback Mode

6 Setting Menu

7 Accessories

8 Appendix

Index

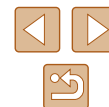



- Windows 7: If the screen in step 2 is not displayed, click the  icon in the taskbar.
- Mac OS: If CameraWindow is not displayed after step 2, click the [CameraWindow] icon in the Dock.
- Although you can save images to a computer simply by connecting your camera to the computer without using the software, the following limitations apply.
 - It may take a few minutes after you connect the camera to the computer until camera images are accessible.
 - Images shot in vertical orientation may be saved in horizontal orientation.
 - Image protection settings may be cleared from images saved to a computer.
 - Some problems may occur when saving images or image information, depending on the operating system version, the software in use, or image file sizes.

Printing Images

► Still Images ► Movies

Your shots can easily be printed by connecting the camera to a printer. On the camera, you can specify images to set up batch printing, prepare orders for photo development services, and prepare orders or print images for photobooks.

A Canon SELPHY CP series compact photo printer is used here for the sake of illustration. Screens displayed and available functions vary by printer. Also refer to the printer manual for additional information.

Easy Print

► Still Images ► Movies

Easily print your shots by connecting the camera to a PictBridge-compatible printer (sold separately) with the USB cable.

1 Make sure the camera and printer are off.

2 Connect the camera to the printer.

- Open the terminal cover. Holding the smaller cable plug in the orientation shown, insert the plug fully into the camera terminal.
- Connect the larger cable plug to the printer. For other connection details, refer to the printer manual.

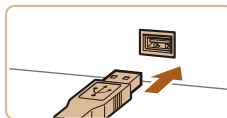
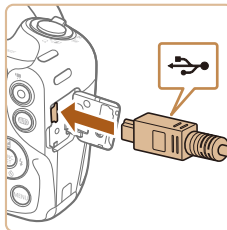

3 Turn the printer on.

Before Use

Basic Guide

Advanced Guide

1 Camera Basics

2 Auto Mode

3 Other Shooting Modes

4 P Mode

5 Playback Mode

6 Setting Menu

7 Accessories

8 Appendix

Index





4 Turn the camera on.

- Press the [▶] button to turn the camera on.

5 Choose an image.

- Press the [◀][▶] buttons to choose an image.



6 Access the printing screen.

- Press the [Ⓜ] button, choose [Print], and press the [Ⓜ] button again.

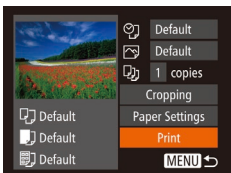

7 Print the image.

- Press the [▲][▼] buttons to choose [Print], and then press the [Ⓜ] button.
- Printing now begins.
- To print other images, repeat the above procedures starting from step 5 after printing is finished.
- When you are finished printing, turn the camera and printer off and disconnect the cable.



- For Canon-brand PictBridge-compatible printers (sold separately), see "Printer" (86).

Configuring Print Settings

▶ Still Images ▶ Movies

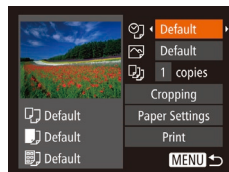

1 Access the printing screen.

- Follow steps 1 – 6 in "Easy Print" (91) to access this screen.

2 Configure the settings.

- Press the [▲][▼] buttons to choose an item, and then press the [◀][▶] buttons to choose an option.

🗨️	Default	Matches current printer settings.
	Date	Prints images with the date added.
	File No.	Prints images with the file number added.
	Both	Prints images with both the date and file number added.
🖨️	Off	–
	Default	Matches current printer settings.
	Off	–
	On	Uses information from the time of shooting to print under optimal settings.
👁️	Red-Eye 1	Corrects red-eye.
	No. of Copies	Choose the number of copies to print.
Cropping	–	Specify a desired image area to print (93).
Paper Settings	–	Specify the paper size, layout, and other details (93).

Before Use

Basic Guide

Advanced Guide

1 Camera Basics

2 Auto Mode

3 Other Shooting Modes

4 P Mode

5 Playback Mode

6 Setting Menu

7 Accessories

8 Appendix

Index

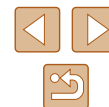

Cropping Images before Printing

► Still Images ► Movies

By cropping images before printing, you can print a desired image area instead of the entire image.

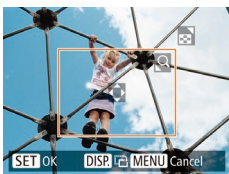
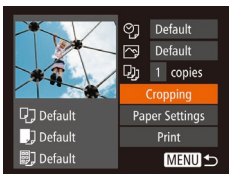

1 Choose [Cropping].

- After following step 1 in “Configuring Print Settings” (92) to access the printing screen, choose [Cropping] and press the [MENU] button.
- A cropping frame is now displayed, indicating the image area to print.

2 Adjust the cropping frame as needed.

- To resize the frame, move the zoom lever.
- To move the frame, press the [▲][▼][◀][▶] buttons.
- To rotate the frame, press the [DISP] button.
- When finished, press the [MENU] button.

3 Print the image.

- Follow step 7 in “Easy Print” (91) to print.



- Cropping may not be possible at small image sizes, or at some aspect ratios.
- Dates may not be printed correctly if you crop images shot with [Date Stamp] selected.

Choosing Paper Size and Layout before Printing

► Still Images ► Movies

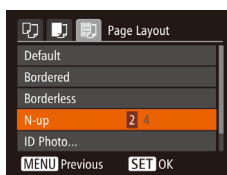
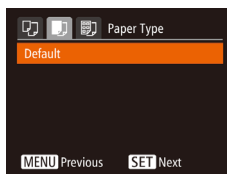
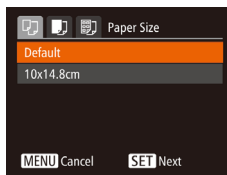
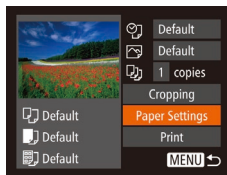

1 Choose [Paper Settings].

- After following step 1 in “Configuring Print Settings” (92) to access the printing screen, choose [Paper Settings] and press the [MENU] button.

2 Choose a paper size.

- Press the [▲][▼] buttons to choose an option, and then press the [MENU] button.

3 Choose a type of paper.

- Press the [▲][▼] buttons to choose an option, and then press the [MENU] button.

4 Choose a layout.

- Press the [▲][▼] buttons to choose an option.
- When choosing [N-up], press the [◀][▶] buttons to specify the number of images per sheet.
- Press the [MENU] button.

5 Print the image.

Before Use

Basic Guide

Advanced Guide

1 Camera Basics

2 Auto Mode

3 Other Shooting Modes

4 P Mode

5 Playback Mode

6 Setting Menu

7 Accessories

8 Appendix

Index



Available Layout Options

Default	Matches current printer settings.
Bordered	Prints with blank space around the image.
Borderless	Borderless, edge-to-edge printing.
N-up	Choose how many images to print per sheet.
ID Photo	Prints images for identification purposes. Only available for images with a resolution of L and an aspect ratio of 4:3.
Fixed Size	Choose the print size. Choose from 3.5 x 5 in., postcard, or wide-format prints.

Printing ID Photos

▶ Still Images ▶ Movies

1 Choose [ID Photo].

- Following steps 1 – 4 in “Choosing Paper Size and Layout before Printing” (📖93), choose [ID Photo] and press the [MENU] button.

2 Choose the long and short side length.

- Press the [▲][▼] buttons to choose an item. Choose the length by pressing the [◀][▶] buttons, and then press the [MENU] button.

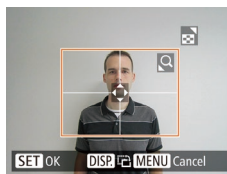
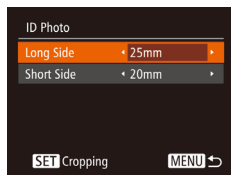

3 Choose the printing area.

- Follow step 2 in “Cropping Images before Printing” (📖93) to choose the printing area.

4 Print the image.

Printing Movie Scenes

▶ Still Images ▶ Movies

1 Access the printing screen.

- Follow steps 1 – 6 in “Easy Print” (📖91) to choose a movie. This screen is displayed.

2 Choose a printing method.

- Press the [▲][▼] buttons to choose [📄], and then press the [◀][▶] buttons to choose the printing method.

3 Print the image.

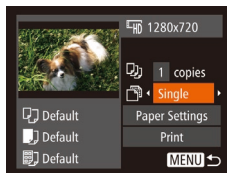

Before Use

Basic Guide

Advanced Guide

1 Camera Basics

2 Auto Mode

3 Other Shooting Modes

4 P Mode

5 Playback Mode

6 Setting Menu

7 Accessories

8 Appendix

Index

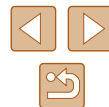

Movie Printing Options

Single	Prints the current scene as a still image.
Sequence	Prints a series of scenes, a certain interval apart, on a single sheet of paper. You can also print the folder number, file number, and elapsed time for the frame by setting [Caption] to [On].



- To cancel printing, press the [MENU] button, choose [OK], and then press the [MENU] button again.
- [ID Photo] and [Sequence] cannot be chosen on Canon-brand PictBridge-compatible printers from CP720/CP730 and earlier models.

Adding Images to the Print List (DPOF)

► Still Images ► Movies

Batch printing (197) and ordering prints from a photo development service can be set up on the camera. Choose up to 998 images on a memory card and configure relevant settings, such as the number of copies, as follows. The printing information you prepare this way will conform to DPOF (Digital Print Order Format) standards.

Configuring Print Settings

► Still Images ► Movies

Specify the printing format, whether to add the date or file number, and other settings as follows. These settings apply to all images in the print list.

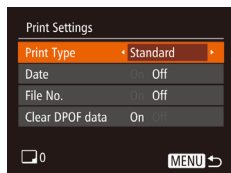

- Press the [MENU] button, and then choose [Print Settings] on the [D] tab. Choose and configure items as desired (125).

Print Type	Standard	One image is printed per sheet.
	Index	Smaller versions of multiple images are printed per sheet.
	Both	Both standard and index formats are printed.
Date	On	Images are printed with the shooting date.
	Off	–
File No.	On	Images are printed with the file number.
	Off	–
Clear DPOF data	On	All image print list settings are cleared after printing.
	Off	–



- Not all of your DPOF settings may be applied in printing by the printer or photo development service, in some cases.
- [!] may be displayed on the camera to warn you that the memory card has print settings that were configured on another camera. Changing the print settings using this camera may overwrite all previous settings.
- Setting [Date] to [On] may cause some printers to print the date twice.



- Specifying [Index] will prevent you from choosing [On] for both [Date] and [File No.] at the same time.
- Index printing is not available on some Canon-brand PictBridge-compatible printers (sold separately).
- The date is printed in a format matching setting details in [Date/Time] on the [T] tab (117).

Before Use

Basic Guide

Advanced Guide

1 Camera Basics

2 Auto Mode

3 Other Shooting Modes

4 P Mode

5 Playback Mode

6 Setting Menu

7 Accessories

8 Appendix

Index



Setting Up Printing for Individual Images

▶ Still Images ▶ Movies

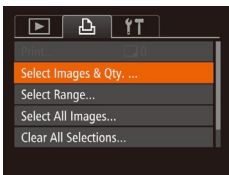

1 Choose [Select Images & Qty.].

- Press the [MENU] button, choose [Select Images & Qty.] on the [L] tab, and then press the [OK] button.

2 Choose an image.

- Press the [◀][▶] buttons to choose an image, and then press the [OK] button.
- You can now specify the number of copies.
- If you specify index printing for the image, it is labeled with a [✓] icon. To cancel index printing for the image, press the [OK] button again. [✓] is no longer displayed.

3 Specify the number of prints.

- Press the [▲][▼] buttons to specify the number of prints (up to 99).
- To set up printing for other images and specify the number of prints, repeat steps 2 – 3.
- Printing quantity cannot be specified for index prints. You can only choose which images to print, by following step 2.
- When finished, press the [MENU] button to return to the menu screen.



Setting Up Printing for a Range of Images

▶ Still Images ▶ Movies

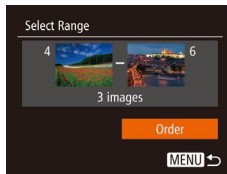

- Following step 1 in “Setting Up Printing for Individual Images” (96), choose [Select Range] and press the [OK] button.
- Follow steps 2 – 3 in “Selecting a Range” (68) to specify images.
- Press the [▲][▼] buttons to choose [Order], and then press the [OK] button.

Setting Up Printing for All Images

▶ Still Images ▶ Movies

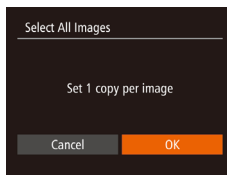

- Following step 1 in “Setting Up Printing for Individual Images” (96), choose [Select All Images] and press the [OK] button.
- Press the [◀][▶] buttons to choose [OK], and then press the [OK] button.

Clearing All Images from the Print List

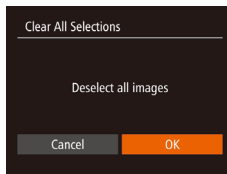

- Following step 1 in “Setting Up Printing for Individual Images” (96), choose [Clear All Selections] and press the [OK] button.
- Press the [◀][▶] buttons to choose [OK], and then press the [OK] button.

Before Use

Basic Guide

Advanced Guide

1 Camera Basics

2 Auto Mode

3 Other Shooting Modes

4 P Mode

5 Playback Mode

6 Setting Menu

7 Accessories

8 Appendix

Index

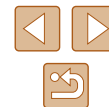

Printing Images Added to the Print List (DPOF)

► Still Images ► Movies

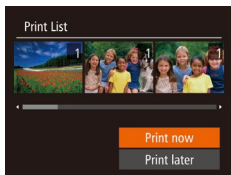

- When images have been added to the print list (📖95 – 📖96), this screen is displayed after you connect the camera to a PictBridge-compatible printer. Press the [▲][▼] buttons to choose [Print now], and then simply press the [⊞] button to print the images in the print list.
- Any DPOF print job that you temporarily stop will be resumed from the next image.

Adding Images to a Photobook

► Still Images ► Movies

Photobooks can be set up on the camera by choosing up to 998 images on a memory card and importing them into the software on your computer, where they are stored in their own folder. This is convenient when ordering printed photobooks online or printing photobooks with your own printer.

Choosing a Selection Method

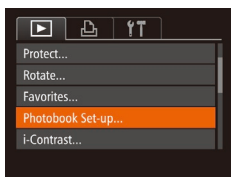

- Press the [MENU] button, choose [Photobook Set-up] on the [D] tab, and then choose how you will select images.



- [!] may be displayed on the camera to warn you that the memory card has print settings that were configured on another camera. Changing the print settings using this camera may overwrite all previous settings.

Adding Images Individually

► Still Images ► Movies

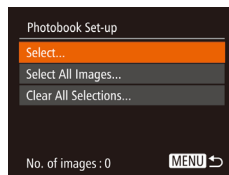

1 Choose [Select].

- Following the procedure in “Choosing a Selection Method” (📖97), choose [Select] and press the [⊞] button.

2 Choose an image.

- Press the [◀][▶] buttons to choose an image, and then press the [⊞] button.
- [✓] is displayed.
- To remove the image from the photobook, press the [⊞] button again. [✓] is no longer displayed.
- Repeat this process to specify other images.
- When finished, press the [MENU] button to return to the menu screen.

Before Use
Basic Guide
Advanced Guide
1 Camera Basics
2 Auto Mode
3 Other Shooting Modes
4 P Mode
5 Playback Mode
6 Setting Menu
7 Accessories
8 Appendix
Index

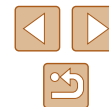

Adding All Images to a Photobook

▶ Still Images ▶ Movies

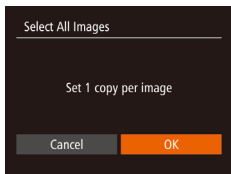

- Following the procedure in “Choosing a Selection Method” (197), choose [Select All Images] and press the [OK] button.
- Press the [◀][▶] buttons to choose [OK], and then press the [OK] button.

Removing All Images from a Photobook

▶ Still Images ▶ Movies

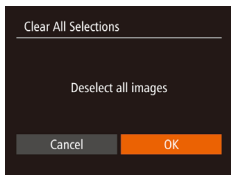

- Following the procedure in “Choosing a Selection Method” (197), choose [Clear All Selections] and press the [OK] button.
- Press the [◀][▶] buttons to choose [OK], and then press the [OK] button.

Using an Eye-Fi Card

▶ Still Images ▶ Movies

Before using an Eye-Fi card, always confirm that local use is permitted (192).

Inserting a prepared Eye-Fi card enables automatic wireless transfer of images to a computer or uploading to a photo-sharing website. Images are transferred by the Eye-Fi card. Refer to the card's user manual or contact the manufacturer for instructions on preparing and using cards or resolving transfer problems.



- When using an Eye-Fi card, keep the following points in mind.
 - Cards may continue to transmit radio waves even when [Eye-Fi trans.] is set to [Disable] (199). Remove the Eye-Fi card before entering hospitals, aircraft, or other areas where transmission is prohibited.
 - When troubleshooting image transfer issues, check the card and computer settings. For details, refer to the card's user manual.
 - Poor Eye-Fi connections may cause image transfer to take a long time, and transfer may be interrupted in some cases.
 - Eye-Fi cards may become hot, due to their transfer functions.
 - Battery power will be consumed faster than in normal use.
 - Camera operation may become sluggish. To resolve this, try setting [Eye-Fi trans.] to [Disable].

Before Use

Basic Guide

Advanced Guide

1 Camera Basics

2 Auto Mode

3 Other Shooting Modes

4 P Mode

5 Playback Mode

6 Setting Menu





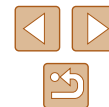

7 Accessories

8 Appendix

Index



Connection status of Eye-Fi cards in the camera can be checked on the shooting screen (in regular information display mode) or playback screen (in simple information display mode).

 (Gray)	Not connected
 (Blinking white)	Connecting
 (White)	Connected
 (Animated)	Transfer in progress*1
	Interrupted
	Not communicating
	Error acquiring Eye-Fi card information*2

*1 Power saving (🔋23) on the camera is temporarily disabled during image transfer.

*2 Restart the camera. Repeated display of this icon may indicate a problem with the card.

Images labeled with a  icon have been transferred.

Checking Connection Information

Check the access point SSID used by the Eye-Fi card or the connection status, as needed.

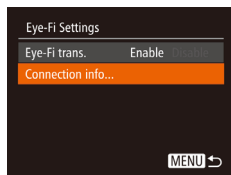

- Press the [MENU] button, choose [Eye-Fi Settings] on the [F1] tab, and then press the [INFO] button.
- Choose [Connection info], and then press the [INFO] button.
- The connection information screen is displayed.

Disabling Eye-Fi Transfer

Configure the setting as follows to disable Eye-Fi transfer by the card, if necessary.

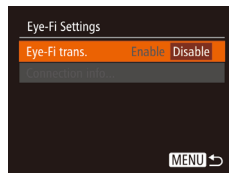

- Press the [MENU] button, choose [Eye-Fi Settings] on the [F1] tab, and then press the [INFO] button.
- Choose [Eye-Fi trans.], and then choose [Disable].



- [Eye-Fi Settings] is not shown unless an Eye-Fi card is in the camera with its write-protect tab in the unlocked position. For this reason, you cannot change settings for an inserted Eye-Fi card if the write-protect tab is in the locked position.

Before Use

Basic Guide

Advanced Guide

1 Camera Basics

2 Auto Mode

3 Other Shooting Modes

4 P Mode

5 Playback Mode

6 Setting Menu

7 Accessories

8 Appendix

Index

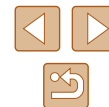

Appendix

Helpful information when using the camera

8

Troubleshooting

If you think there is a problem with the camera, first check the following. If the items below do not solve your problem, contact a Canon Customer Support Help Desk.

Power

Nothing happens when the ON/OFF button is pressed.

- Confirm that the battery pack is charged (15).
- Confirm that the battery pack is inserted facing the correct way (16).
- Confirm that the memory card/battery cover is fully closed (16).
- Dirty battery terminals reduce battery performance. Try cleaning the terminals with a cotton swab and reinserting the battery pack a few times.

The battery pack runs out of power quickly.

- Battery performance decreases at low temperatures. Try warming the battery pack a little by putting it in your pocket, for example, ensuring that the terminals do not touch any metal objects.
- Dirty battery terminals reduce battery performance. Try cleaning the terminals with a cotton swab and reinserting the battery pack a few times.
- If these measures do not help and the battery pack still runs out of power soon after charging, it has reached the end of its life. Purchase a new battery pack.

The lens is not retracted.

- Do not open the memory card/battery cover while the camera is on. Close the cover, turn the camera on, and then turn it off again (16).

The battery pack is swollen.

- Battery swelling is normal and does not pose any safety concerns. However, if battery swelling prevents the battery pack from fitting in the camera, contact a Canon Customer Support Help Desk.

Display on a TV

Camera images look distorted or not displayed on a TV (87).

Before Use

Basic Guide

Advanced Guide

1 Camera Basics

2 Auto Mode

3 Other Shooting Modes

4 P Mode

5 Playback Mode

6 Setting Menu

7 Accessories

8 Appendix

Index

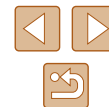

Shooting

Cannot shoot.

- In Playback mode (📖61), press the shutter button halfway (📖23).

Strange display on the screen under low light (📖24).

Strange display on the screen when shooting.

- Note that the following display problems are not recorded in still images but are recorded in movies.
 - The screen may darken under bright light.
 - The screen may flicker under fluorescent or LED lighting.
 - Purplish banding may appear on the screen if you compose a shot that includes a bright light source.

No date stamp is added to images.

- Configure the [Date Stamp] (📖) setting (📖17). Note that date stamps are not added to images automatically, merely because you have configured the [Date/Time] setting (📖35).
- Date stamps are not added in shooting modes (📖109) in which this setting cannot be configured (📖35).

[📷] flashes on the screen when the shutter button is pressed, and shooting is not possible (📖30).

[📷] is displayed when the shutter button is pressed halfway (📖30).

- Set [IS Mode] to [Continuous] (📖60).
- Raise the flash and set the flash mode to [📷] (📖58).
- Increase the ISO speed (📖51).
- Mount the camera on a tripod or take other measures to keep it still. Additionally, you should set [IS Mode] to [Off] when using a tripod or other means to secure the camera (📖60).

Shots are out of focus.

- Press the shutter button halfway to focus on subjects before pressing it all the way down to shoot (📖23).
- Make sure subjects are within focusing range (📖115).
- Set [AF-assist Beam] to [On] (📖39).
- Confirm that unneeded functions such as macro are deactivated.
- Try shooting with focus lock or AF lock (📖55, 📖58).

No AF frames are displayed and the camera does not focus when the shutter button is pressed halfway.

- To have AF frames displayed and the camera focus correctly, try composing the shot with higher-contrast subject areas centered before you press the shutter button halfway. Otherwise, try pressing the shutter button halfway repeatedly.

Subjects in shots look too dark.

- Raise the flash and set the flash mode to [📷] (📖58).
- Adjust brightness by using exposure compensation (📖50).
- Adjust contrast by using i-Contrast (📖52, 📖75).
- Use AE lock or spot metering (📖50, 📖51).

Subjects look too bright, highlights are washed-out.

- Lower the flash and set the flash mode to [📷] (📖28).
- Adjust brightness by using exposure compensation (📖50).
- Use AE lock or spot metering (📖50, 📖51).
- Reduce the lighting on subjects.

Shots look too dark despite the flash firing (📖30).

- Shoot within flash range (📖114).
- Increase the ISO speed (📖51).

Subjects in flash shots look too bright, highlights are washed-out.

- Shoot within flash range (📖114).
- Lower the flash and set the flash mode to [📷] (📖28).

White dots or similar image artifacts appear in flash shots.

- This is caused by light from the flash reflecting off dust or airborne particles.

Shots look grainy.

- Lower the ISO speed (📖51).

Subjects are affected by red-eye.

- Set [Red-Eye Lamp] to [On] (📖40) to activate the red-eye reduction lamp (📖3) in flash shots. Note that while the red-eye reduction lamp is on (for about one second), it is not possible to shoot, because the lamp is counteracting red-eye. For best results, have subjects look at the red-eye reduction lamp. Also try increasing the lighting in indoor scenes and shooting at closer range.
- Edit images using red-eye correction (📖75).

Before Use

Basic Guide

Advanced Guide

1 Camera Basics

2 Auto Mode

3 Other Shooting Modes

4 P Mode

5 Playback Mode

6 Setting Menu

7 Accessories

8 Appendix

Index

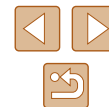

Recording to the memory card takes too long, or continuous shooting is slower.

- Use the camera to perform low-level formatting of the memory card (📖81).

Shooting settings or FUNC. menu settings are not available.

- Available setting items vary by shooting mode. Refer to “Functions Available in Each Shooting Mode”, “FUNC. Menu”, and “Shooting Tab” (📖106 – 📖109).

Shooting Movies

The elapsed time shown is incorrect, or recording is interrupted.

- Use the camera to format the memory card, or switch to a card that supports high-speed recording. Note that even if the elapsed time display is incorrect, the length of movies on the memory card corresponds to the actual recording time (📖80, 📖114).

[!] is displayed and shooting stops automatically.

- The camera’s internal memory buffer filled up as the camera could not record to the memory card quickly enough. Try one of the following measures.
 - Use the camera to perform low-level formatting of the memory card (📖81).
 - Lower the image quality (📖37).
 - Switch to a memory card that supports high-speed recording (📖114).

Zooming is not possible.

- Zooming is not possible when shooting movies in [📹] mode (📖45).

Playback

Playback is not possible.

- Image or movie playback may not be possible if a computer is used to rename files or alter the folder structure.

Playback stops, or audio skips.

- Switch to a memory card that you have performed low-level formatting on with the camera (📖81).
- There may be brief interruptions when playing movies copied to memory cards that have slow read speeds.
- When movies are played on a computer, frames may be dropped and audio may skip if computer performance is inadequate.

Sound is not played during movies.

- Adjust the volume (📖77) if you have activated [Mute] (📖77) or the sound in the movie is faint.
- No sound is played for movies shot in [📹] mode (📖45) because audio is not recorded in this mode.

Memory Card

The memory card is not recognized.

- Restart the camera, with the memory card in it (📖22).

Computer

Cannot transfer images to a computer.

- When attempting to transfer images to the computer via a cable, try reducing the transfer speed as follows.
 - Press the [📷] button to enter Playback mode. Hold the [MENU] button down as you press the [▲] and [🔍] buttons at the same time. On the next screen, press the [◀][▶] buttons to choose [B], and then press the [🔍] button.

Eye-Fi Cards

Cannot transfer images (📖98).

Before Use

Basic Guide

Advanced Guide

1 Camera Basics

2 Auto Mode

3 Other Shooting Modes

4 P Mode

5 Playback Mode

6 Setting Menu

7 Accessories

8 Appendix

Index

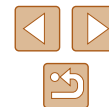

On-Screen Messages

If an error message is displayed, respond as follows.

No memory card

- The memory card may be inserted facing the wrong way. Reinsert the memory card facing the correct way (📖16).

Memory card locked

- The write-protect tab of the memory card is set to the locked position. Switch the write-protect tab to the unlocked position (📖16).

Cannot record!

- Shooting was attempted without a memory card in the camera. To shoot, insert a memory card facing the correct way (📖16).

Memory card error (📖81)

- If the same error message is displayed even after you have formatted a supported memory card (📖2) and have inserted it facing the correct way (📖16), contact a Canon Customer Support Help Desk.

Insufficient space on card

- There is not enough free space on the memory card to shoot (📖28, 📖42, 📖49) or edit images (📖73). Either erase unneeded images (📖69) or insert a memory card with enough free space (📖16).

Charge the battery (📖15)

No Image.

- The memory card does not contain any images that can be displayed.

Protected! (📖67)

Unidentified Image/Incompatible JPEG/Image too large./Cannot play back MOV/Cannot play back MP4

- Unsupported or corrupt images cannot be displayed.
- It may not be possible to display images that were edited or renamed on a computer, or images shot with another camera.

Cannot magnify!/Cannot play back this content in Smart Shuffle/Cannot rotate/Cannot modify image/Cannot modify!/Cannot assign to category/Unselectable image.

- The following functions may be unavailable for images that were renamed or already edited on a computer, or images shot with another camera. Note that starred (*) functions are not available for movies. Magnify* (📖65), Smart Shuffle* (📖66), Rotate* (📖71), Favorites (📖72), Edit* (📖73), Print List* (📖95), and Photobook Set-up* (📖97).

Invalid selection range

- When specifying a range for image selection (📖68, 📖70, 📖96), you attempted to choose an initial image that was after the final image, or vice-versa.

Exceeded selection limit

- More than 998 images were selected for Print List (📖95) or Photobook Set-up (📖97). Choose 998 images or less.
- Print List (📖95) or Photobook Set-up (📖97) settings could not be saved correctly. Reduce the number of selected images and try again.
- You attempted to choose more than 500 images in Protect (📖67), Erase (📖69), Favorites (📖72), Print List (📖95), or Photobook Set-up (📖97).

Naming error!

- The folder could not be created or images could not be recorded, because the highest supported folder number (999) for storing images on the card has been reached and the highest supported image number (9999) for images in folders has been reached. On the (📁) tab, change [File Numbering] to [Auto Reset] (📖81), or format the memory card (📖80).

Lens Error

- This error may occur if the lens is held while it is moving, or when the camera is used in dusty or sandy locations.
- Frequent display of this error message may indicate camera damage. In this case, contact a Canon Customer Support Help Desk.

A camera error was detected (*error number*)

- If this error message is displayed immediately after a shot, the image may not have been saved. Switch to Playback mode to check for the image.
- Frequent display of this error message may indicate camera damage. In this case, write down the error number (*Exx*) and contact a Canon Customer Support Help Desk.

File Error

- Correct printing (📖91) may not be possible for photos from other cameras or images that have been altered using computer software, even if the camera is connected to the printer.

Before Use

Basic Guide

Advanced Guide

1 Camera Basics

2 Auto Mode

3 Other Shooting Modes

4 P Mode

5 Playback Mode

6 Setting Menu

7 Accessories

8 Appendix

Index



Print error

- Check the paper size setting (193). If this error message is displayed when the setting is correct, restart the printer and complete the setting on the camera again.

Ink absorber full

- Contact a Canon Customer Support Help Desk to request assistance with ink absorber replacement.

On-Screen Information

Shooting (Information Display)

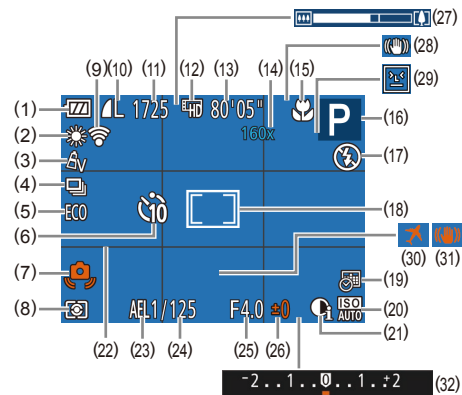

- | | |
|---|--|
| (1) Battery level (105) | (12) Movie quality (37) |
| (2) White balance (52) | (13) Remaining time (114) |
| (3) My Colors (53) | (14) Digital zoom magnification (33),
Digital tele-converter (55) |
| (4) Drive mode (35) | (15) Focusing range (54,
55), AF lock (58) |
| (5) Eco mode (79) | (16) Shooting mode (106), Scene
icon (31) |
| (6) Self-timer (33) | (17) Flash mode (58) |
| (7) Camera shake warning (30) | (18) AF frame (55), Spot AE point
frame (51) |
| (8) Metering method (51) | (19) Date stamp (35) |
| (9) Eye-Fi connection status (98) | (20) ISO speed (51) |
| (10) Still image compression (59),
Resolution (37) | |
| (11) Recordable shots (114) | |

Before Use

Basic Guide

Advanced Guide

1 Camera Basics

2 Auto Mode

3 Other Shooting Modes

4 P Mode

5 Playback Mode

6 Setting Menu

7 Accessories

8 Appendix

Index



- (21) i-Contrast (📖52)
- (22) Grid lines (📖38)
- (23) AE lock (📖50), FE lock (📖59)
- (24) Shutter speed
- (25) Aperture value
- (26) Exposure compensation level (📖50)
- (27) Zoom bar (📖28)
- (28) IS mode icon (📖32)
- (29) Blink detection (📖39)
- (30) Time zone (📖78)
- (31) Image stabilization (📖60)
- (32) Exposure compensation bar (📖50)

Battery Level

An on-screen icon or message indicates the battery charge level.

Display	Details
	Sufficient charge
	Slightly depleted, but sufficient
	Nearly depleted—charge the battery pack soon
[Charge the battery]	Depleted—charge the battery pack immediately

Playback (Detailed Information Display)

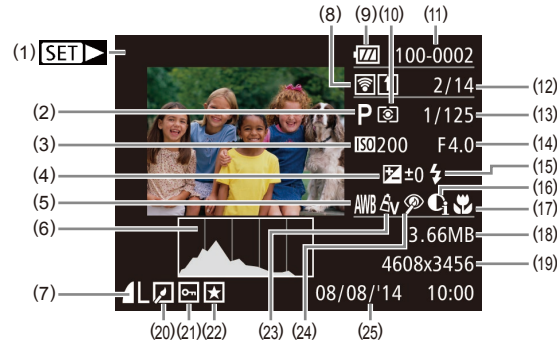

- (1) Movies (📖28, 📖61)
- (2) Shooting mode (📖106)
- (3) ISO speed (📖51), Playback speed (📖45)
- (4) Exposure compensation level (📖50)
- (5) White balance (📖52)
- (6) Histogram (📖63)
- (7) Compression (image quality) (📖59) / Resolution (📖37), MOV (movies)
- (8) Transferred via Eye-Fi (📖98)
- (9) Battery level (📖105)
- (10) Metering method (📖51)
- (11) Folder number - File number (📖81)
- (12) Current image no. / Total no. of images
- (13) Shutter speed (still images), Image quality / Frame rate (movies) (📖37)
- (14) Aperture value
- (15) Flash (📖58)
- (16) i-Contrast (📖52, 📖75)
- (17) Focusing range (📖54, 📖55)
- (18) File size
- (19) Still images: Resolution (📖114) Movies: Playback time (📖114)
- (20) Image editing (📖73)
- (21) Protection (📖67)
- (22) Favorites (📖72)
- (23) My Colors (📖53, 📖74)
- (24) Red-eye correction (📖75)
- (25) Shooting date/time (📖17)

Before Use

Basic Guide

Advanced Guide

1 Camera Basics

2 Auto Mode

3 Other Shooting Modes

4 P Mode

5 Playback Mode

6 Setting Menu

7 Accessories

8 Appendix

Index

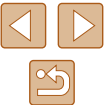

Flash (📖58)



AUTO / P / LIVE / /



AUTO / P / LIVE / /



AUTO*2 / P / LIVE / /



AUTO / P / LIVE / /



AE Lock/FE Lock (📖50, 📖59)*3

AUTO / P / LIVE / /



AF Lock (📖58)

AUTO / P / LIVE / /



Focusing Range (📖54, 📖55)



AUTO / P / LIVE / /



AUTO / P / LIVE / /



Tracking AF (📖56)

AUTO / P / LIVE / /



Change Display (📖24)

AUTO / P / LIVE / /



*1 Settings [Dark – Light].

*2 Not available, but switches to in some cases.

*3 FE lock not available in flash mode.

FUNC. Menu

Metering Method (📖51)



AUTO / P / LIVE / /



AUTO / P / LIVE / /



My Colors (📖53)



AUTO / P / LIVE / /



AV / AN / AS*1 / AW*1 / AP / AL / AD / AB / AG / AR / AC*2

AUTO / P / LIVE / /



White Balance (📖52)



AUTO / P / LIVE / /



/ / / /

AUTO / P / LIVE / /



Before Use

Basic Guide

Advanced Guide

1 Camera Basics

2 Auto Mode

3 Other Shooting Modes

4 P Mode

5 Playback Mode

6 Setting Menu

7 Accessories

8 Appendix

Index



ISO Speed (📖51)

ISO
AUTO

AUTO/P/LIVE /  / 

ISO
100 / 200 / 400 / 800 / 1600

AUTO/P/LIVE /  / 

Drive Mode (📖35)



AUTO/P/LIVE /  / 



AUTO/P/LIVE /  / 

Still Image Aspect Ratio (📖36)

16:9

AUTO/P/LIVE /  / 



AUTO/P/LIVE /  / 

4:3

AUTO/P/LIVE /  / 



Resolution (📖37)

L

AUTO/P/LIVE /  / 

M1/M2/S

AUTO/P/LIVE /  / 

M

AUTO/P/LIVE /  / 

Compression (📖59)

S

AUTO/P/LIVE /  / 



AUTO/P/LIVE /  / 

Movie Quality (📖37)

HD / VGA

AUTO/P/LIVE /  / 



*1 White balance is not available.

*2 Set in a range of 1 – 5: contrast, sharpness, color saturation, red, green, blue, and skin tone.

*3 Synchronizes with the aspect ratio setting and is automatically set (📖45).

Before Use

Basic Guide

Advanced Guide

1 Camera Basics

2 Auto Mode

3 Other Shooting Modes

4 P Mode

5 Playback Mode

6 Setting Menu

7 Accessories

8 Appendix

Index

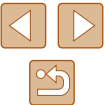

Shooting Tab

AF Frame (📖55)

Face AiAF*1

AUTO / P / LIVE /  

Tracking AF

AUTO / P / LIVE /  

Center

AUTO / P / LIVE /  

AF Frame Size (📖55)*2

Normal

AUTO / P / LIVE /  

Small

AUTO / P / LIVE /  

Digital Zoom (📖33)

Standard

AUTO / P / LIVE /  

Off

AUTO / P / LIVE /  

1.6x/2.0x

AUTO / P / LIVE /  

AF-Point Zoom (📖38)

On

AUTO / P / LIVE /  

Off

AUTO / P / LIVE /  

Servo AF (📖57)

On

AUTO / P / LIVE /  

Off*3

AUTO / P / LIVE /  

Continuous AF (📖57)

On

AUTO / P / LIVE /  

Off

AUTO / P / LIVE /  

AF-assist Beam (📖39)

On

AUTO / P / LIVE /  

Off

AUTO / P / LIVE /  

Before Use

Basic Guide

Advanced Guide

1 Camera Basics

2 Auto Mode

3 Other Shooting Modes

4 P Mode

5 Playback Mode

6 Setting Menu

7 Accessories

8 Appendix

Index



Flash Settings (40)

Red-Eye Lamp

On/Off

AUTO / P / LIVE /  /  /  /  /  /  /  /  /  /  /  /  / 



i-Contrast (52)

Auto

AUTO / P / LIVE /  /  /  /  /  /  /  /  /  /  /  /  / 



Off

AUTO / P / LIVE /  /  /  /  /  /  /  /  /  /  /  /  / 



Review image after shooting (40)

Display Time

Off/Quick/2 sec./4 sec./8 sec./Hold

AUTO / P / LIVE /  /  /  /  /  /  /  /  /  /  /  /  / 



Display Info

Off/Detailed

AUTO / P / LIVE /  /  /  /  /  /  /  /  /  /  /  /  / 



Blink Detection (39)

On

AUTO / P / LIVE /  /  /  /  /  /  /  /  /  /  /  /  / 



Off

AUTO / P / LIVE /  /  /  /  /  /  /  /  /  /  /  /  / 



Grid Lines (38)

On/Off

AUTO / P / LIVE /  /  /  /  /  /  /  /  /  /  /  /  / 



IS Settings (60)

IS Mode

Continuous/Off

AUTO / P / LIVE /  /  /  /  /  /  /  /  /  /  /  /  / 



Shoot Only

AUTO / P / LIVE /  /  /  /  /  /  /  /  /  /  /  /  / 



Dynamic IS

1

AUTO / P / LIVE /  /  /  /  /  /  /  /  /  /  /  /  / 



2

AUTO / P / LIVE /  /  /  /  /  /  /  /  /  /  /  /  / 



Date Stamp (35)

Off

AUTO / P / LIVE /  /  /  /  /  /  /  /  /  /  /  /  / 



Date / Date & Time

AUTO / P / LIVE /  /  /  /  /  /  /  /  /  /  /  /  / 



*1 Operation when no faces are detected by shooting mode.

*2 Available when the AF frame is set to [Center].

*3 [On] when subject movement is detected in [AUTO] mode.

Before Use

Basic Guide

Advanced Guide

1 Camera Basics

2 Auto Mode

3 Other Shooting Modes

4 P Mode

5 Playback Mode

6 Setting Menu

7 Accessories

8 Appendix

Index



Set Up Tab

Item	Ref. Page
Mute	77
Volume	77
Hints & Tips	78
Date/Time	17
Time Zone	78
Lens Retraction	79
Eco Mode	79
Power Saving	23, 79
LCD Brightness	80
Start-up Image	80
Format	80, 81
File Numbering	81
Create Folder	82
Video System	87
Eye-Fi Settings	98
Certification Logo Display	82
Language	18
Reset All	83

Playback Tab

Item	Ref. Page
Slideshow	65
Erase	69
Protect	67
Rotate	71
Favorites	72
Photobook Set-up	97
i-Contrast	75
Red-Eye Correction	75
Cropping	73
Resize	73
My Colors	74
Transition	61
Scroll Display	61
Auto Rotate	71
Resume	61

Before Use

Basic Guide

Advanced Guide

1 Camera Basics

2 Auto Mode

3 Other Shooting Modes

4 P Mode

5 Playback Mode

6 Setting Menu

7 Accessories

8 Appendix

Index



Print Tab

Item	Ref. Page
Print	–
Select Images & Qty.	96
Select Range	96
Select All Images	96
Clear All Selections	96
Print Settings	95

Playback Mode FUNC. Menu

Item	Ref. Page
Rotate	71
Protect	67
Favorites	72
Print	91
Play Movie	61
Smart Shuffle	66
Image Search	64
Slideshow	65

Handling Precautions

- The camera is a high-precision electronic device. Avoid dropping it or subjecting it to strong impact.
- Never bring the camera near magnets, motors, or other devices that generate strong electromagnetic fields, which may cause malfunction or erase image data.
- If water droplets or dirt adheres to the camera or screen, wipe with a dry soft cloth, such as an eyeglass cloth. Do not rub hard or apply force.
- Never use cleaners containing organic solvents to clean the camera or screen.
- Use a blower brush to remove dust from the lens. If cleaning is difficult, contact a Canon Customer Support Help Desk.
- To prevent condensation from forming on the camera after sudden temperature changes (when the camera is transferred from cold to warm environments), put the camera in an airtight, resealable plastic bag and let it gradually adjust to the temperature before removing it from the bag.
- If condensation does form on the camera, stop using it immediately. Continuing to use the camera in this state may damage it. Remove the battery pack and memory card, and wait until the moisture has evaporated before resuming use.
- Before long-term battery storage, use up the battery pack's remaining charge, remove it from the camera, and store it in a plastic bag or similar container. Storing a partially charged battery pack over extended periods (about a year) may shorten its life or affect performance.

Before Use

Basic Guide

Advanced Guide

1 Camera Basics

2 Auto Mode

3 Other Shooting Modes

4 P Mode

5 Playback Mode

6 Setting Menu

7 Accessories

8 Appendix

Index

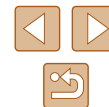

Specifications

Camera Specifications

Camera Effective Pixels (Max.)	Approx. 20.0 million pixels
Lens Focal Length	40x zoom: 4.3 (W) – 172.0 (T) mm (35mm film equivalent: 24 (W) – 960 (T) mm)
LCD Monitor	7.5 cm (3.0 in.) color TFT LCD Effective Pixels: Approx. 230,000 dots
File Format	Design rule for Camera File system, DPOF (version 1.1) compliant
Data Type	Still Images: Exif 2.3 (JPEG) Movies: MOV (Video: MPEG-4 AVC/H.264; Audio: Linear PCM (monaural))
Interface	Hi-speed USB Analog audio output (monaural) Analog video output (NTSC/PAL)
Power Source	Battery Pack NB-11LH AC Adapter Kit ACK-DC90
Dimensions (Based on CIPA Guidelines)	104.4 x 69.1 x 85.1 mm (4.11 x 2.72 x 3.35 in.)
Weight (Based on CIPA Guidelines)	Approx. 325 g (approx. 11.5 oz.; including the battery pack and memory card) Approx. 308 g (approx. 10.9 oz.; camera body only)

Digital Zoom Focal Length (35mm film equivalent)

Digital Zoom [Standard]	24 – 3840 mm (Represents the combined focal length of optical and digital zoom.)
Digital Tele-Converter 1.6x	38.4 – 1536 mm
Digital Tele-Converter 2.0x	48.0 – 1920 mm

Number of Shots/Recording Time, Playback Time

Number of Shots	Approx. 185
Number of Shots (Eco Mode On)	Approx. 245
Movie Recording Time*1	Approx. 45 minutes
Movie Recording Time (Continuous Shooting*2)	Approx. 1 hour 35 minutes
Playback Time	Approx. 4 hours

*1 Times are under the following shooting conditions.

- Auto mode
- Image quality [E-HD]
- Repeated shooting, stopping, zooming, turning power on/off

*2 Times are under the following shooting conditions.

- Auto mode
- Image quality [E-HD]
- No operations such as zooming
- Shooting immediately resumed after automatically stopping when the file size reaches 4 GB or the recording time reaches 29 min. 59 sec.

*3 Time for still images played back in a slideshow.

- The number of shots that can be taken is based on measurement guidelines of the Camera & Imaging Products Association (CIPA).
- Under some shooting conditions, the number of shots and recording time may be less than mentioned above.
- Number of shots/time with a fully charged battery pack.

Before Use

Basic Guide

Advanced Guide

1 Camera Basics

2 Auto Mode

3 Other Shooting Modes

4 P Mode

5 Playback Mode

6 Setting Menu

7 Accessories









8 Appendix

Index





Number of Shots per Memory Card



The number of shots at an aspect ratio (📖36) of 4:3 per memory card is as follows. Note that the number of shots available varies by aspect ratio.

Recording Pixels	Compression Ratio	Number of Shots per Memory Card (Approx. shots)
		16 GB
L (Large) 20M/5152x3864		1698
		2760
M1 (Medium 1) 10M/3648x2736		3217
		5061
M2 (Medium 2) 3M/2048x1536		9344
		16755
S (Small) 0.3M/640x480		53992
		80988



- The values in the table are based on Canon measurement conditions and may change depending on the subject, memory card and camera settings.

Recording Time per Memory Card

Image Quality	Recording Time per Memory Card
	16 GB
	2 hr. 21 min. 58 sec.
	6 hr. 44 min. 38 sec.

- The values in the table are based on Canon measurement conditions and may change depending on the subject, memory card and camera settings.
- Recording will automatically stop when the clip file size reaches 4 GB, or when the recording time reaches approximately 29 minutes and 59 seconds when shooting in , or approximately 1 hour when shooting in .
- Recording may stop even if the maximum clip length has not been reached on some memory cards. SD Speed Class 2 or higher memory cards are recommended.

Flash Range

Maximum wide angle ()	50 cm – 5.0 m (1.6 – 16 ft.)
Maximum telephoto ()	1.4 – 2.7 m (4.6 – 8.9 ft.)

Before Use

Basic Guide

Advanced Guide

1 Camera Basics

2 Auto Mode

3 Other Shooting Modes

4 P Mode

5 Playback Mode

6 Setting Menu





7 Accessories

8 Appendix

Index



Shooting Range

Shooting Mode	Focusing Range	Maximum Wide Angle ()	Maximum Telephoto ()
AUTO	—	0 cm (0 in.) – infinity	1.4 m (4.6 ft.) – infinity
Other modes		5 cm (2.0 in.) – infinity	1.4 m (4.6 ft.) – infinity
		0 – 50 cm (0 in. – 1.6 ft.)	—
		3.0 m (9.8 ft.) – infinity	3.0 m (9.8 ft.) – infinity

Not available in some shooting modes.

Continuous Shooting Speed

Shooting Mode	Speed
AUTO P	Approx. 0.5 shots/sec.
	Approx. 2.2 shots/sec.

Shutter Speed

[AUTO] mode, automatically set range	1 – 1/4000 sec.
---	-----------------

Aperture

f/number	f/3.5 – f/8.0 (W), f/6.3 – f/8.0 (T)
----------	--------------------------------------

Battery Pack NB-11LH

Type: Rechargeable lithium-ion battery
 Nominal Voltage: 3.6 V DC
 Nominal Capacity: 800 mAh
 Charging Cycles: Approx. 300 times
 Operating Temperatures: 0 – 40 °C (32 – 104 °F)

Battery Charger CB-2LF/CB-2LFE

Rated Input: 100 – 240 V AC (50/60 Hz)
 Rated Output: 4.2 V DC, 0.41 A
 Charging Time: Approx. 2 hr. 20 min. (when using NB-11LH)
 Charge Indicator: Charging: orange / Fully charged: green
 (two-indicator system)
 Operating Temperatures: 5 – 40 °C (41 – 104 °F)

Before Use

Basic Guide

Advanced Guide

1 Camera Basics

2 Auto Mode

3 Other Shooting Modes

4 P Mode

5 Playback Mode

6 Setting Menu

7 Accessories

8 Appendix

Index

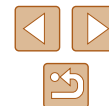

Index

A

AC adapter kit 85, 87
Accessories 85
AE lock 50
AF frames 55
AF lock 58
Aspect ratio 36
Auto mode (shooting mode) 19, 28
AV cable 86, 87

B

Batteries
→ Date/time (date/time battery)
Power saving 23
Battery charger 2, 85
Battery pack
Charging 15
Eco mode 79
Level 105
Power saving 23
Black and white images 53
Blink detection 39

C

Camera
Reset all 83
CameraWindow (computer) 89
Center (AF frame mode) 55
Clock 27
Color (white balance) 52
Compression ratio (image quality) 59
Cropping 73, 93
Custom white balance 53

D

Date/time
Adding date stamps 35
Changing 17
Date/time battery 18
Settings 17
World clock 78
DC coupler 87
Defaults → Reset all
Digital tele-converter 55
Digital zoom 33
Display language 18
DPOF 95

E

Eco mode 79
Editing
Cropping 73
i-Contrast 75
My Colors 74
Red-eye correction 75
Resizing images 73
Erasing 69
Erasing all 70
Error messages 103
Exposure
AE lock 50
Compensation 50
FE lock 59
Eye-Fi cards 2, 98

F

Face AiAF (AF frame mode) 56
Face self-timer (shooting mode) 47
Favorites 72
FE lock 59
File numbering 81
Fireworks (shooting mode) 43
Fish-eye effect (shooting mode) 44
Flash
Off 59
On 58
Slow synchro 58
Focusing
AF frames 55
AF lock 58
AF-point zoom 38
Servo AF 57
Focusing range
Infinity 55
Macro 54
Focus lock 55
FUNC. menu
Basic operations 24
Table 107, 112

G

Grid lines 38

H

Household power 87

I

i-Contrast 52, 75
Image quality
→ Compression ratio (image quality)
Images
Display period 40

Erasing 69
Playback → Viewing
Protecting 67
Image stabilization 60
Indicator 26
Infinity (focusing range) 55
ISO speed 51

L

Lamp 40
Live View Control (shooting mode) 42
Long shutter (shooting mode) 47
Low light (shooting mode) 43

M

Macro (focusing range) 54
Magnified display 65
Memory cards 2
Recording time 114
Menu
Basic operations 25
Table 106
Metering method 51
Miniature effect (shooting mode) 45
Monochrome (shooting mode) 46
Movies
Editing 76
Image quality
(resolution/frame rate) 37
Recording time 114
My Colors 53, 74

P

P (shooting mode) 49
Package contents 2
Photobook set-up 97
PictBridge 86, 91
Playback → Viewing

Before Use

Basic Guide

Advanced Guide

1 Camera Basics

2 Auto Mode

3 Other Shooting Modes

4 P Mode

5 Playback Mode

6 Setting Menu

7 Accessories

8 Appendix

Index



Portrait (shooting mode) 43
 Poster effect
 (shooting mode) 44
 Power 85
 → AC adapter kit
 → Battery charger
 → Battery pack
 Power saving 23
 Printing 91
 Program AE 49
 Protecting 67

R
 Red-eye correction 75
 Reset all 83
 Resizing images 73
 Resolution (image size) 37
 Rotating 71

S
 Saving images to a computer 90
 Screen
 Display language 18
 Icons 104, 105
 Menu → FUNC. menu
 SD/SDHC/SDXC memory cards
 → Memory cards
 Searching 64
 Self-timer 33
 2-second self-timer 34
 Customizing the self-timer 34
 Face self-timer
 (shooting mode) 47
 Sepia tone images 53
 Servo AF 57
 Shooting
 Shooting information 104
 Shooting date/time → Date/time

Slideshow 65
 Smart Shuffle 66
 Snow (shooting mode) 43
 Software
 Installation 89
 Saving images to a computer 90
 Sounds 77
 Strap 2, 14
 Super vivid (shooting mode) 44

T
 Terminal 87, 91
 Toy camera effect
 (shooting mode) 46
 Tracking AF 56
 Traveling with the camera 78
 Troubleshooting 100
 TV display 87

V
 Viewing 20
 Image search 64
 Index display 63
 Magnified display 65
 Single-image display 20
 Slideshow 65
 Smart Shuffle 66
 TV display 87

W
 White balance (color) 52
 World clock 78
 Wrist strap → Strap

Z
 Zoom 19, 29, 33

Before Use
Basic Guide
Advanced Guide
1 Camera Basics
2 Auto Mode
3 Other Shooting Modes
4 P Mode
5 Playback Mode
6 Setting Menu
7 Accessories
8 Appendix
Index



Trademarks and Licensing

- Microsoft and Windows are trademarks or registered trademarks of Microsoft Corporation in the United States and/or other countries.
- Macintosh and Mac OS are trademarks of Apple Inc., registered in the U.S. and other countries.
- The SDXC logo is a trademark of SD-3C, LLC.
- All other trademarks are the property of their respective owners.
- This device incorporates exFAT technology licensed from Microsoft.
- This product is licensed under AT&T patents for the MPEG-4 standard and may be used for encoding MPEG-4 compliant video and/or decoding MPEG-4 compliant video that was encoded only (1) for a personal and non-commercial purpose or (2) by a video provider licensed under the AT&T patents to provide MPEG-4 compliant video. No license is granted or implied for any other use for MPEG-4 standard.

Disclaimer

- Unauthorized reproduction of this guide is prohibited.
- All measurements based on Canon testing standards.
- Information subject to change without notice, as are product specifications and appearance.
- Illustrations and screenshots in this guide may differ slightly from the actual equipment.
- The above items notwithstanding, Canon cannot be held liable for any loss arising from the use of this product.

Before Use

Basic Guide

Advanced Guide

1 Camera Basics

2 Auto Mode

3 Other Shooting Modes

4 P Mode

5 Playback Mode

6 Setting Menu

7 Accessories

8 Appendix

Index

