

OSCAR NEST OF TABLES

Assembly Instructions - Please keep for future reference

389/7612

424/5005

397/6980

392/6930

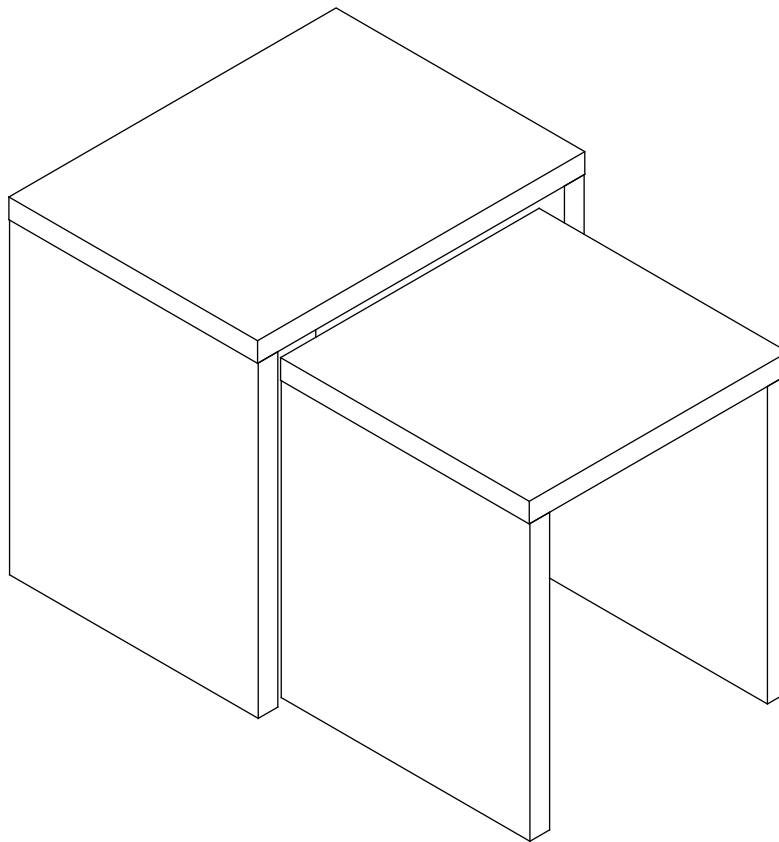

Dimensions

Large Table

Width - 50cm

Depth - 38 cm

Height - 50 cm

Dimensions

Small Table

Width - 39.5cm

Depth - 38 cm

Height - 45 cm

Important - Please read these instructions fully before starting assembly

If you need help or have damaged or missing parts, call the **Customer Helpline: 0345 6400 800**



Safety and Care Advice

Important – Please read these instructions fully before starting assembly

Check you have all the components and tools listed on pages 2 and 3.

Remove all fittings from the plastic bags and separate them into their groups.

Keep children and animals away from the work area, small parts could choke if swallowed. Make sure you have enough space to layout the parts before starting.

Assemble the item as close to its final position (in the same room) as possible.

Assemble on a soft level surface to avoid damaging the unit or your floor.

Assembly requires 2 people. Keep this instructions for future use.

Do not stand or put excessive weight on the product, this could cause damage.



We do not recommend the use of power drill/drivers **for inserting screws**,

as this could damage the unit. Only use hand screwdrivers and Allen keys.

Dispose of all packaging carefully and responsibly.

Care and maintenance

Only clean using a damp cloth and mild detergent, do not use bleach or abrasive cleaners.

From time to time check that there are no loose screws on this unit.

This product should not be discarded with household waste. Take to your local authority waste disposal centre.

Components - Parts

If you have damaged or missing components.
call the **Customer Helpline**: 0345 6400 800

Please check you have all the parts listed below

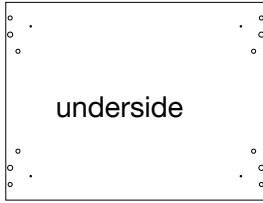

- 1** Large Top x 1
(50x38x3cm)

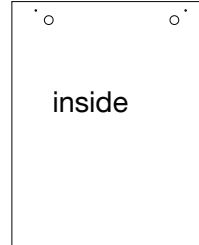

- 2** Large side panel x 2
(47x37.8x3cm)

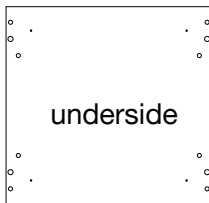

- 3** Small Top x 1
(39.5x38x3cm)

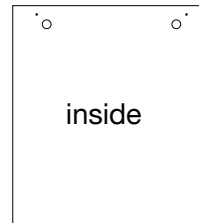







- 4** Small Side panel x 2
(42x37.8x3cm)

Components - Fittings

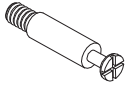
If you have damaged or missing components, call the **Customer Helpline: 0345 6400 800**

Please check you have all the fittings listed below

Note: The quantities below are the correct amount to complete the assembly. In some cases more fittings may be supplied than are required.

<p>A</p>  <p>Metal dowel x 8</p>	<p>B</p>  <p>Locking nut x 8</p>	<p>C</p>  <p>Wooden dowel x 16</p>
<p>D</p>  <p>Sticker x 10</p>	<p>E</p>  <p>EVA pad x 8</p>	<p>F</p>  <p>16mm Wood screw x 16</p>
<p>G</p>  <p>Metal plate x 8</p>		

Tools required

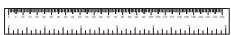

Ruler/tape measure



Phillips screwdriver
(Not supplied)

Ruler - Use this ruler to help correctly identify the screws

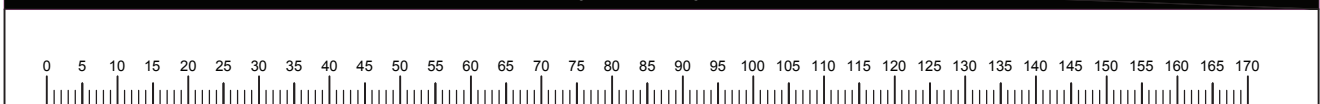

Assembly Instructions

Step 1

Preparing panels

Place large top **1** and large side panels **2** flat onto the floor with the fixing holes facing up.

Screw metal dowels **A** into large top **1** as shown.

Note: Screw metal dowels as far as shown. Do not overtighten.

Insert wood dowels **C** into large side panels **2** as shown.

Large Table

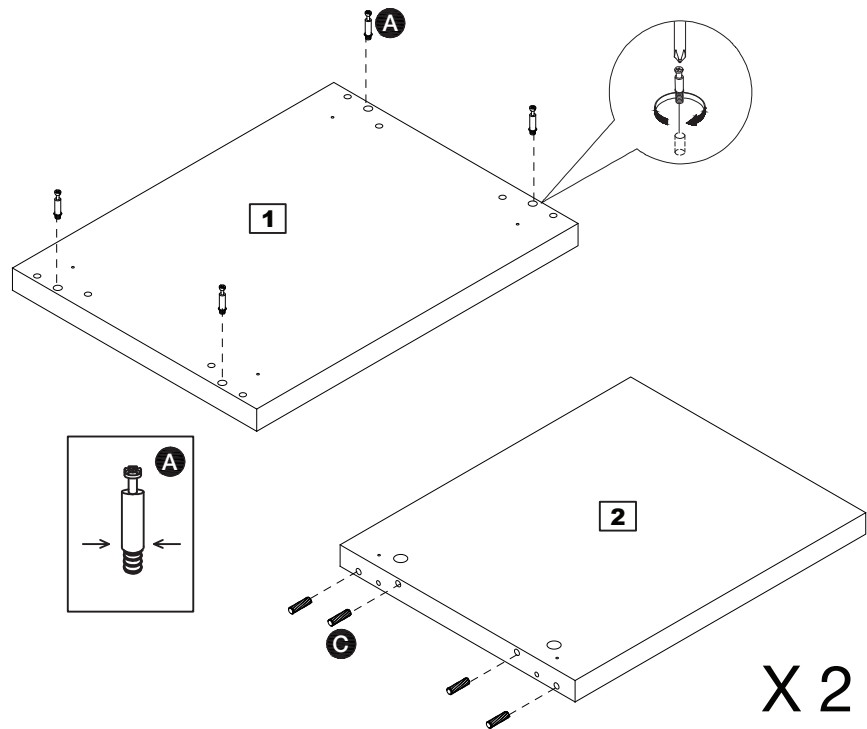

Step 2

Assembling side panel

Carefully locate large side panels **2** onto large top panel **1**.

Insert locking nuts **B** into the holes in large side panels **2**.

Turn locking nuts **B** clockwise to secure.

Stickers **D** can be used to cover the fixing holes.

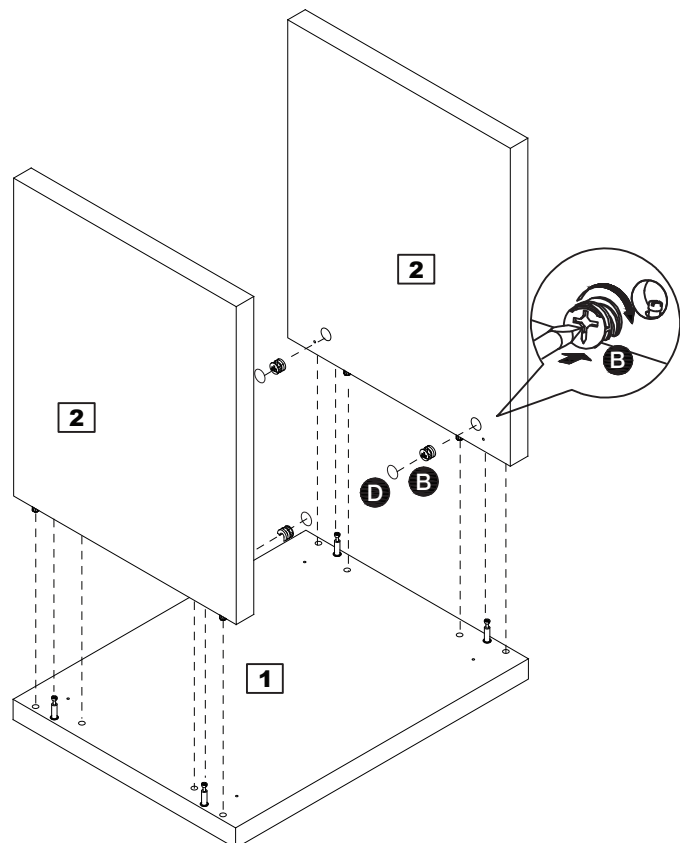

Assembly Instructions

Step 3

Securing side panels

Further secure side panels **2** using metal brackets **G** and wood screws **F** as shown.

Stick self adhesive EVA pads **E** onto the underside of large panels **2** as shown.

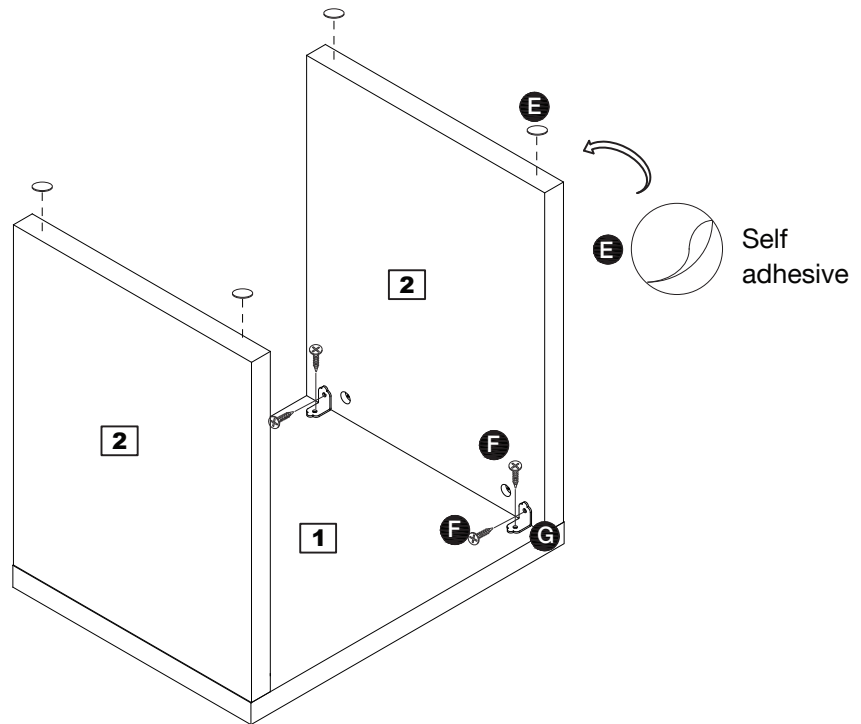

Step 4

Assembling small table

Repeat steps 1 to 3 using small table components **3** and **4** as shown.

Small Table

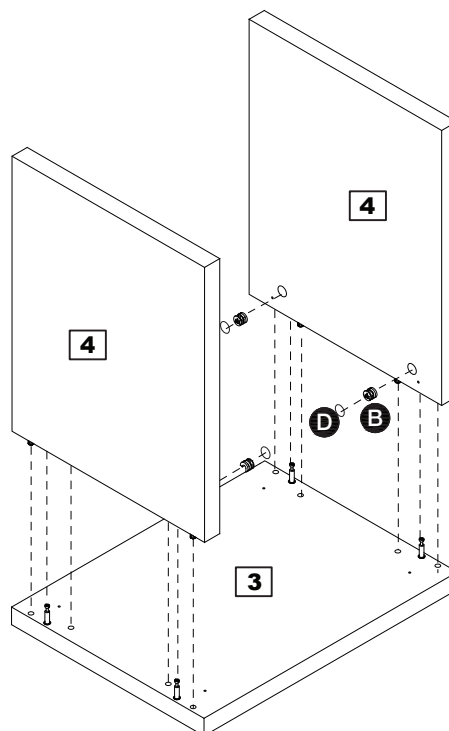

Assembly Instructions

Step 5

Turn both tables upright and nest together.

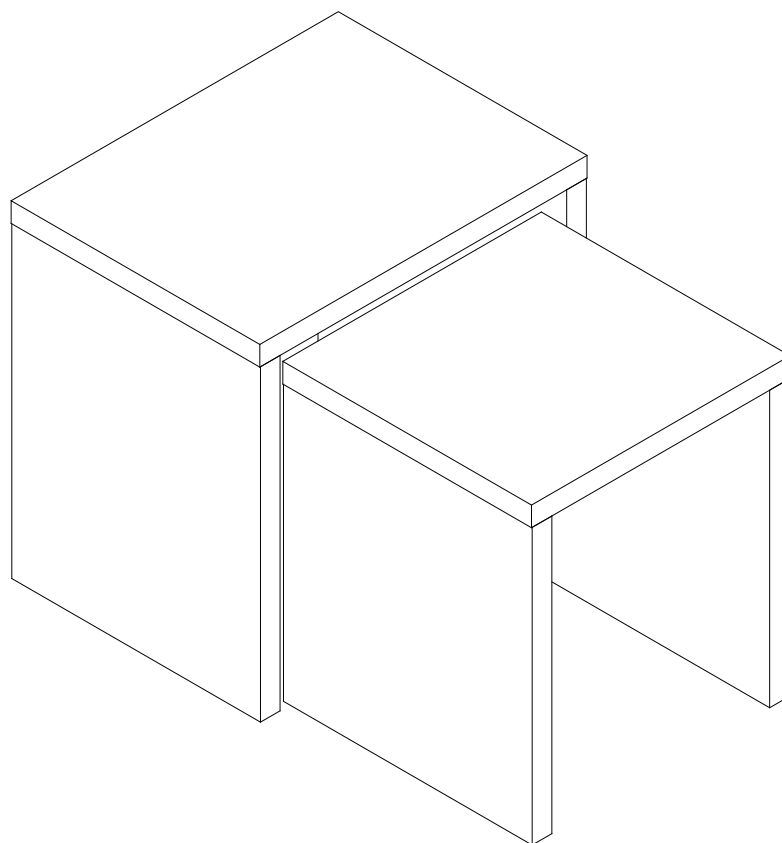

Assembly is complete.

If you need help or have damaged or missing parts, call the **Customer Helpline: 0345 6400 800**
Home Retail Group, 489-499 Avebury Boulevard, Saxon Gate West, Central Milton Keynes, MK9 2NW