

BUSH

Instruction Manual

CBAR7W



Table of contents

Disposal information	1
Safety information	2
Care & maintenance	2
DTS TruSurround	2
Accessories included	3
Overview of controls	3
Overview of remote	4
Remote battery usage	4
Subwoofer connection	4
TV Connections	5
Auxiliary connections	6
Mains connection	6
Standby mode	6
General operation	6
Switching inputs	6
Adjusting the volume level	6
Sound effect presets	6
Bass enhancement	7
Mute function	7
Sleep timer	7
Adjusting the display brightness	7
Bluetooth operation	7
Pairing a Bluetooth device	7
Bluetooth status table	8
Controlling a paired device	8
Bluetooth notes	8
Wall mounting the sound bar	9
Wall mounting advice	9
Troubleshooting	10
Technical specifications	10

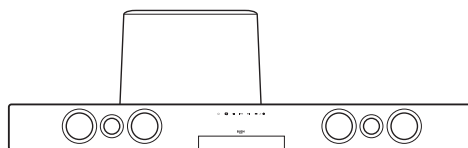

Product Codes

CBAR7W

Disposal information



WEEE marking "Information for the consumer"

Disposal of your old product Your product is designed and manufactured with high quality materials and components, which can be recycled and reused. When this crossed out wheeled bin symbol is attached to a product it means the product is covered by the European Directive 2002/96/EC. Please make yourself aware of the local collection system for electrical and electronic products. Please act according to your local rules and do not dispose of your old products with your normal household waste.

The correct disposal of your old product will help prevent potential negative consequences for the environment and human health.



This product complies with European low voltage (2006/95/EC) and electromagnetic compatibility (2004/108/EC) directives.

Safety information

Important – Please read these instructions fully before installation

Safety information

CAUTION: TO REDUCE THE RISK OF ELECTRIC SHOCK, DO NOT REMOVE ANY COVER. NO USER-SERVICEABLE PARTS INSIDE, REFER ANY SERVICING TO QUALIFIED SERVICE PERSONNEL.

- Please read this owner's guide
- Please take the time to follow the instructions in this owner's guide carefully. It will help you set up and operate your system properly and enjoy all of its advanced features.
- Please save this owner's guide for future reference.
- The product label is located on the back of the product.
- Heed all warnings - on the product and in the owner's guide.
- This product must be used indoors. It is neither designed nor tested for use outdoors, in recreation vehicles, or on boats.
- The apparatus shall not be exposed to dripping or splashing and that no objects filled with liquids, such as vases, shall be placed on the apparatus.
- Do not use this product near a bathtub, washbowl, kitchen sink, and laundry tub, in a wet basement, near a swimming pool, or anywhere else that water or moisture is present.
- Batteries, shall not be exposed to excessive heat such as sunshine, fire or the like.
- Only use attachments/accessories specified by the manufacturer.
- Unplug this apparatus during lightning storms or when unused for long periods of time - to prevent damage to this product.
- Refer all servicing to qualified service personnel
- Servicing is required when the apparatus has been damaged in any way: such as liquid has been spilled or objects have fallen into the apparatus; the apparatus has been exposed to rain or moisture, does not operate normally, or has been dropped -
- Do not attempt to service this product yourself.
- Opening or removing covers may expose you to dangerous voltages or other hazards.
- To prevent risk of fire or electric shock, avoid overloading wall outlets, extension cords, or integral convenience receptacles.
- Use proper power sources - Plug the product into a proper power source, as described in the operating instructions or as marked on the product.
- The mains plug is used as the disconnect device, the disconnect device shall remain readily accessible.



This symbol means that this unit is double insulated. An earth connection is not required.

Care & maintenance

⚠ Important: Always unplug the appliance from the power socket during cleaning and maintenance.

- Ensure the unit is switched off and unplugged from any electrical outlet
- Wipe the case with a slightly moist lint free cloth
- Do not use any cleaning fluids containing alcohol, ammonia or abrasives
- Do not spray an aerosol at or near the object
- Do not allow liquids to spill or objects to drop into any openings
- Do not insert sharp items into speaker grills or any other openings
- Always use the original packaging if it is necessary to transport the unit at any time
- If the unit is used in a dusty environment, it may be necessary to have the unit serviced at your local dealer periodically. It is not advisable to allow large deposits of dust to accumulate within the unit as it may prevent adequate cooling. Similarly dust deposits which become damp can sometimes lead to electrical problems which may cause severe damage to the delicate electronics within this unit.



The Bluetooth® word mark and logos are registered trademarks owned by Bluetooth SIG, Inc. and any use of such marks is under license

Functions & controls

Please familiarize yourself with the parts and accessories listed below

Accessories included

- 1 x CBAR7W
- 1 x Sub woofer
- 1 x Remote control
- 1 x CR2025 battery
- 1 x Audio cable (Coaxial)
- 1 x Audio cable (Optical)
- 1 x Audio cable (RCA - 3.5mm)
- 1 x Audio cable (RCA - RCA)
- 1 x Instruction manual

Overview of controls

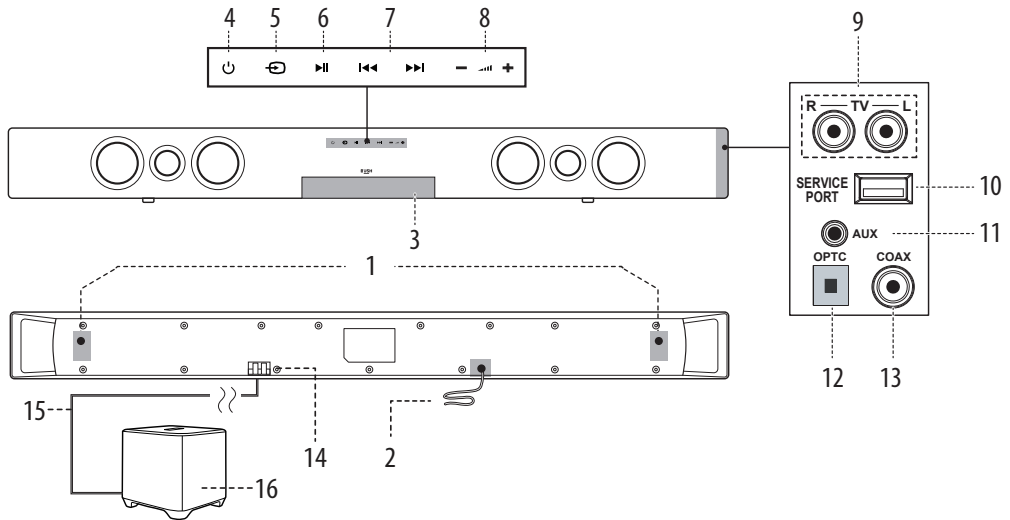

1 WALL-MOUNT BRACKETS: Use these brackets to fix the Sound bar to a wall.

2 MAINS POWER CABLE: Connect to a **UK** mains outlet.

3 DISPLAY: Indicates the current status of the unit.

4 STANDBY touch button: Switch on the Sound bar or switch to **STANDBY** mode.

5 SOURCE touch button: Select an audio source from **TV, AUX, COAX, BT** or **OPTICAL** inputs.

6 ►/|| PLAY/PAUSE touch button: **START** or **PAUSE** Bluetooth playback.

7 SKIP ◀◀/▶▶ touch button: Skip previous & next buttons for bluetooth playback.

8 VOLUME +/- touch buttons: Increase or decrease the output volume.

9 TV AUDIO INPUT (RCA): Connect the analogue audio output from a **TV** or other audio source.

10 SERVICE PORT: This **USB** port is used **ONLY** for software updates.

11 AUX AUDIO INPUT (3.5mm): Connect the analogue audio output from an **MP3** player or similar using a **3.5mm** audio cable.

12 OPTICAL AUDIO INPUT: Connect the digital audio output from a **TV, DVD** or Blu-ray player.

13 COAXIAL AUDIO INPUT (RCA): Connect the digital audio output from a **TV, DVD** or Blu-ray player.

14 SUBWOOFER SPEAKER TERMINALS: Connect to the external subwoofer.

15 SPEAKER CABLE: Connect the external subwoofer to the Sound Bar.

16 SUBWOOFER

User instructions

Overview of remote

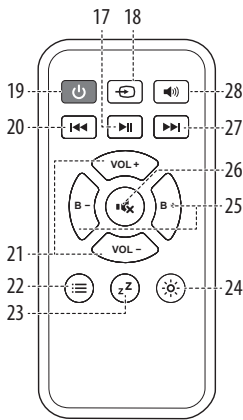

- 17 ►/|| PLAY/PAUSE:** **START** or **PAUSE** Bluetooth playback.
- 18 SOURCE:** Select an audio source from **TV, AUX, COAX, BT** or **OPTICAL** inputs.
- 19 STANDBY:** Switch on the Sound bar or switch to **STANDBY** mode.
- 20 SKIP ◀◀:** Skip to previous track for Bluetooth playback.
- 21 VOLUME - / +:** Increase or decrease the volume output.
- 22 OPTION:** Press and hold for **5** seconds to **'Unpair'** a connected Bluetooth device.
- 23 SLEEP:** Activates the sleep timer function.
- 24 DIM:** Press this button to adjust the display brightness.
- 25 BASS - / +:** Increase or decrease the bass output.
- 26 MUTE:** Press to mute the sound output.
- 27 SKIP ▶▶:** Skip to next track for Bluetooth playback.
- 28 SOUND EQ MODES:** Press repeatedly to assign different sound **EQ** modes: **STANDARD, MOVIE, MUSIC** or **NEWS**.

Remote battery usage

Using the remote for the first time

Before use, pull the tab out from the bottom of the remote control. This allows the terminals contact with the pre-installed battery.

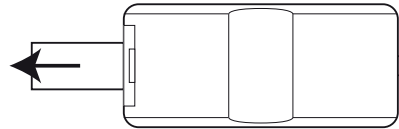

Installing batteries in the remote

1: Push open the battery compartment on the bottom of the remote control using a fingernail.

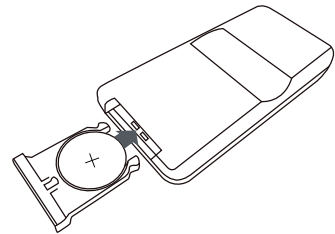

- 2:** Insert a **CR2025** battery into the space taking care to match the **+** & **-** polarity symbols correctly.
- 3:** Replace the battery compartment.

Disposal of batteries

Dispose of used batteries with regard to the recycling regulations in your area. Do **NOT** short circuit batteries or throw them into water, the general rubbish or in a fire. Weak batteries can leak and damage the remote control. Replace them in good time!

Subwoofer connection

- 1:** Connect the speaker cable from external subwoofer to the socket on back of the Sound bar. Take care to match the cable with **RED** line to the **RED** socket and the **WHITE** cable to the **BLACK** socket.

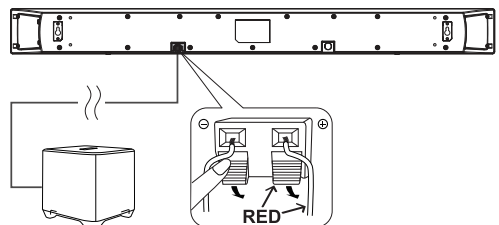

User instructions

TV Connections

1) Connecting a TV, DVD or GAMES CONSOLE using the supplied RCA - RCA audio cable.

NOTE: Ensure that the TV PHONO connectors are audio OUTPUTS and not audio INPUTS. If they are INPUTS then use connection 4 instead of 1.

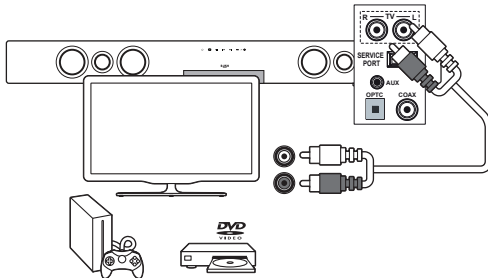

- 1: Connect one end of the **RCA cable (supplied)** to the **TV, DVD or CONSOLE** audio output **RCA** sockets.
- 2: Connect the other end to the **TV** inputs on the side of the Sound bar **(9)**.

NOTE: Take care to match the **RED** plug to the **RED** socket and the **WHITE** plug to the **WHITE** socket.

2) DIGITAL connection to a TV, DVD or Blu-ray player using the supplied COAXIAL cable.

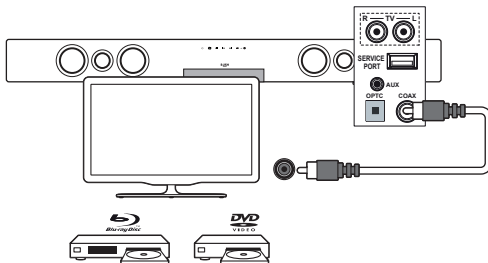

- 1: Connect one end of the **RCA COAX** cable **(supplied)** to the **TV, DVD** or Blu-ray **COAXIAL** audio output **RCA** socket.
- 2: Connect the other end to the **COAX** input on the side of the Sound bar **(13)**.

NOTE: You may need to activate PCM (Downmix) on your source device EG:- TV, DVD or Blu-ray player.

3) DIGITAL connection to a TV, DVD or Blu-ray player using the supplied OPTICAL cable.

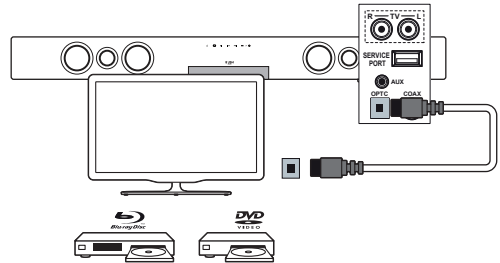

- 1: Connect one end of the **OPTICAL cable (supplied)** to the **TV, DVD** or Blu-ray **OPTICAL** audio output socket.
- 2: Connect the other end to the **OPTIC** input on the side of the Sound bar **(12)**.

NOTE: You may need to activate PCM (Downmix) on your source device EG:- TV, DVD or Blu-ray player.

4) Connection to a TV using the supplied RCA - 3.5mm audio cable.

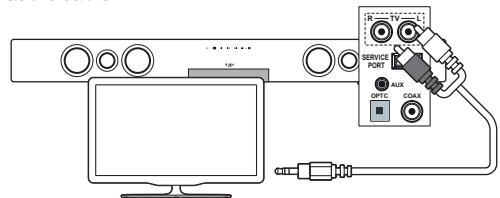

- 1: Connect the **3.5mm (small)** end of the cable **(supplied)** to the **TV** headphone **3.5mm** audio output socket.
- 2: Connect the other **RED & WHITE** ends to the **TV** inputs on the side of the Sound bar **(9)**, taking care to match the **RED** plug to the **RED** socket and the **WHITE** plug to the **WHITE** socket.

NOTE: In some cases the Sound bar volume output is effected by the volume level on the TV. In this case adjust the TV volume to increase the audio output from the sound bar.

NOTE: If no sound can be heard from the sound bar using this connection, you may need to check your TV settings to enable the headphone socket output.

User instructions

Auxiliary connections

Connecting an MP3 player

The below diagram shows the connection to an audio device such as an MP3 player, using a 3.5mm audio cable (not supplied).

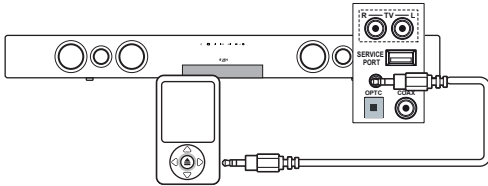

- 1: Connect one end of the **3.5mm** audio cable to the headphone output of your **MP3** player.
- 2: Connect the other end to the **AUX** input (**3.5mm socket**) on the side of the Sound bar (**11**).

Mains connection

Connecting mains power

- 1: Connect the attached mains plug to a **UK** mains power supply outlet.
- 2: Switch the power outlet **ON**.

Standby mode

Standby mode

- 1: Press the **STANDBY** button (**4 Unit & 19 Remote**) to wake the unit from **STANDBY** mode.
- 2: To enter **STANDBY** mode press either **STANDBY** buttons (**4 Unit & 19 Remote**).

NOTE: As part of the power saving mode the unit will enter **STANDBY** mode automatically after 20 minutes (approx) of no audio output.

General operation

Switching inputs

Follow the below steps to switch inputs between : TV, Auxilliary, Coaxial, Bluetooth or Optical.

- 1: Ensure the Sound bar is powered **ON**. If not press the **STANDBY** button (**4**) or remote (**19**).
- 2: Press the **SOURCE** button (**5, 18**) repeatedly until you reach the required input mode.

Switching inputs (cont)

TV input: TV
Auxilliary input: AUX
Coaxial input: COAX
Bluetooth input: BT
Optical input: OPTC

NOTE: When switching inputs there will be a 5 second pause after selecting BT while the unit scans for paired devices.

Adjusting the volume level

- 1: To increase the volume level press the **VOLUME +** button (**8 Unit or 21 Remote**) repeatedly or press and hold for fast adjustment.

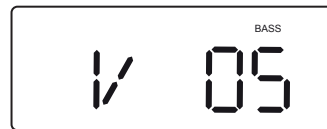

- 2: To decrease the volume level press the **VOLUME -** button (**8 Unit or 21 Remote**) repeatedly or press and hold for fast adjustment.

Sound effect presets

- 1: During playback pressing the **SOUND EQ** button on the remote control (**28**) repeatedly cycles through the available sound modes.

Choose between : - **STANDARD (STD)**, **MOVIE**, **MUSIC** or **NEWS**.



- 2: As you select a sound mode the corresponding name appears on the display to indicate that sound mode is active.

NOTE: The **STANDARD** sound mode when selected does not show an icon on the display.

User instructions

Bass enhancement

- 1: To increase the bass level press the **BASS (B)+** button (25) repeatedly.

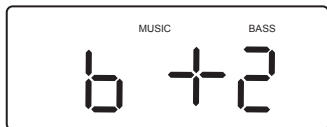

- 2: To decrease the bass level press the **BASS (B)-** button (25) repeatedly.

NOTE: The BASS levels range from -4 to +4.

Mute function

- 1: Pressing the **MUTE** button (26) on the remote will temporarily silence the audio output. You will see 'MUTE' flash on the display to indicate the mute function is active.



- 2: Press the **MUTE** button again to resume the audio output.

Sleep timer

The unit can be set to enter **STANDBY** mode after a period of time.

- 1: During playback mode of either **TV, COAX, OPTICAL** or **AUX** modes, press the **SLEEP** button (23) to enter the timer settings.
- 2: Press the **SLEEP** button repeatedly to cycle through the available time duration options of: - **5, 10, 15, 30, 45, 60, 90** minutes & **OFF**.

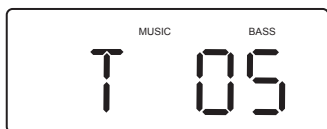

- 3: When you have selected the required timer duration, just leave all buttons untouched for **2** seconds and the timer will begin the countdown.

Sleep timer (cont)

- 4: When the timer elapses the **STANDBY** mode will be activated.

Adjusting the display brightness

- 1: Press the **DIM.** button (24) repeatedly to cycle through the **3** brightness states **LOW, MED & HIGH**.

Bluetooth operation

Pairing a Bluetooth device

Before you can use the sound bar with your phone or other bluetooth capable device you will need to pair the device to the sound bar.

- 1: Press the **SOURCE** button (5, 18) repeatedly until you see 'BT' appear on the display.

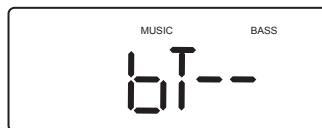

- 2: When selected the 'BT' text on the display will flash rapidly after **5** seconds while the unit tries to connect to previously paired devices. If no devices are found the 'BT' text will still flash but slowly to indicate it is ready for pairing a new device.
- 3: Enable the Bluetooth function on your audio device and search for a device labelled '**BUSH CBAR7W**' in the available list.
- 4: Select and enable pairing for the '**BUSH CBAR7W**' device. If prompted for a password enter '**0000**'.
- 5: If pairing is successful the **CBAR7W** will beep and the 'BT' text will stop flashing.
- 6: If the connected device goes out of range, the sound bar will attempt to connect for **2** minutes. When the device comes into range the sound bar will reconnect again automatically.
- 7: To remove the paired device using only the sound bar, press and hold the **OPTION** button (22) on the remote control. The 'BT' text will begin flashing slowly again.

User instructions

Bluetooth status table

'BT' state	Reason
'BT' solid (no flash)	<ul style="list-style-type: none">• Connected
'BT' flash rapidly	<ul style="list-style-type: none">• Auto re-connecting with last paired device.• If no connection can be made inside 2 minutes pairing mode will begin.
'BT' flash slowly	<ul style="list-style-type: none">• Pairing mode

Controlling a paired device

Once connected you can either use the controls on the audio device to begin playback, skip tracks etc. Or you can use the control buttons on the speaker bar & remote.

- 1:** The **PLAY/PAUSE** button (**6 or 17**) when pressed will begin playback of the selected track on the audio device. Press again to pause playback.
- 2:** To skip to the next track press the **SKIP ►►►** button (**7 or 27**).
- 3:** To skip to the previous track press the **SKIP ◄◄◄** button (**7 or 20**).
- 4:** Any further operations must be done from the audio device.

NOTE: the volume output is effected by the volume level on the audio source EG: Phone or laptop, so make sure that is set to about 70-80% (not too loud to avoid distortion).

Bluetooth notes

- The operation range of bluetooth is approximately 10 meters (30 Feet). Any obstacles in the path between devices may reduce this range.
- Only one Bluetooth device can be paired at a time.
- Not all Bluetooth devices are compatible.

User instructions

Wall mounting the sound bar

- 1: Align the Sound bar in the chosen location. Use a pencil to mark the drilling positions **750mm** apart.

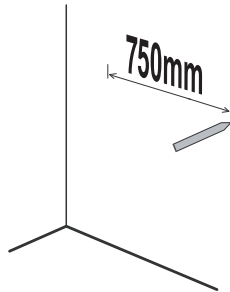

NOTE: The Sound bar should be located at least 7.5cm below the bottom of the TV.

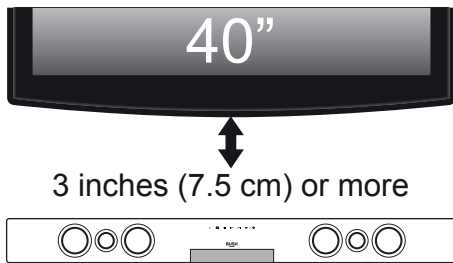

- 2: Drill holes as marked in step 1.

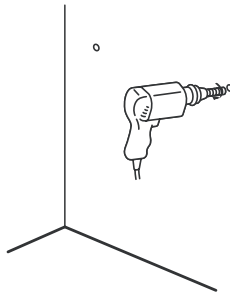

- 3: Insert **2** screws (not supplied) into the holes and tighten. Take care to leave **5mm** between the screw heads and the wall.



NOTE: You will need to ensure the screws are long enough to sufficiently grip the wall while allowing 5mm between screw head & wall.

- 4: Hook the Sound bar into the screws. For secure mounting ensure the screw heads slide firmly into the narrow part of the brackets.

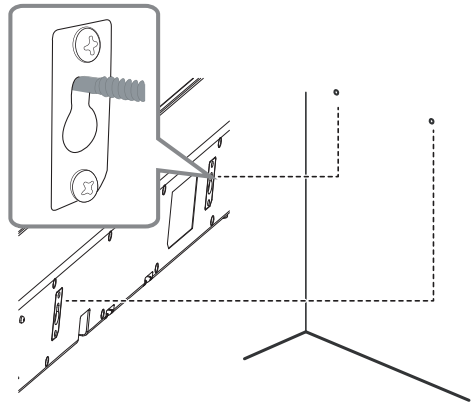

Wall mounting advice

- In order to avoid damage to the equipment and personal injury you should get a qualified person to drill the fixing surface and fit the appropriate wall fixings.
- Take care not to allow the main unit to fall while attempting to hook onto the wall mount brackets.
- Before mounting, check the wall strength, if it is not clear then consult relevant qualified personnel.
- When drilling into walls, always check that there are no hidden wires or pipes etc.
- Make sure the screws & wall plugs are suitable for supporting the unit.

Troubleshooting & Maintenance

Troubleshooting

In the unlikely event of difficulties with your appliance please follow the trouble shooting guide below.

If the problem persists, contact the retailer if the machine is still under guarantee.

Customer helpline: 0870 600 3030

PROBLEM	POSSIBLE SOLUTION
No Power	<ul style="list-style-type: none"> • Ensure the mains plug is connected to a power supply, and is switched ON. • Make sure there is power to the mains socket.
No Sound	<ul style="list-style-type: none"> • Make sure if playing from the AUX input, the external source has the volume turned up and is playing a track. • Make sure the volume is turned up. • If using the digital coaxial or optical cable connection ensure the source DIGITAL output is set to PCM, LPCM, PCM 2Ch stereo or PCM downmix. • Bluetooth device not paired. Check 'Bluetooth operation'.
No response from the unit	<ul style="list-style-type: none"> • Unplug the power cable for 1 minute then plug back in again.
Remote control does not work	<ul style="list-style-type: none"> • Reduce the distance between the remote and main unit • Check the batteries are installed correctly. • Replace the batteries • Aim the remote directly at the Sound bar
Unit powers off after 20 minutes	<ul style="list-style-type: none"> • This unit is designed to enter STANDBY mode automatically after 20 MINUTES of inactivity. Press the STANDBY button to wake the unit.

Technical specifications

Amplifier	
Power Output	• 200W MAX
Frequency response	• 20Hz - 20KHz ± 3dB
Input sensitivity	• 550 mV
Main unit	
Power supply	• 100-240V ~ 50-60Hz
Power consumption	• 35W
Standby power consumption	• ≤0.5W
Full range speaker drivers	<ul style="list-style-type: none"> • Impedance: 4 Ohm, 52mm (2") • Frequency response: 250Hz ~ 20KHz
Subwoofer	<ul style="list-style-type: none"> • Impedance: 8 Ohm, 156mm (6") • Frequency response: 35~250Hz
Dimensions	• Soundbar: 930 x 90 x 60mm Sub woofer: 264 x 251 x 274mm
Cable length	• 1.5m
Remote control	
Battery	• 1 x CR2025
Bluetooth	
Bluetooth compatibility	• EDR, A2DP, AVRCP
Bluetooth version	• 2.1

Guarantee

BUSH

PRODUCT GUARANTEE

This product is guaranteed against manufacturing defects for a period of



Year

This product is guaranteed for twelve months from the date of original purchase.

Any defect that arises due to faulty materials or workmanship will either be replaced, refunded or repaired free of charge where possible during this period by the dealer from whom you purchased the unit.

The guarantee is subject to the following provisions:

- The guarantee does not cover accidental damage, misuse, cabinet parts, knobs or consumable items.
- The product must be correctly installed and operated in accordance with the instructions contained in this manual.
- It must be used solely for domestic purpose.
- The guarantee will be rendered invalid if the product is re-sold or has been damaged by inexpert repair.
- Specifications are subject to change without notice.
- The manufacturer disclaims any liability for the incidental or consequential damages.
- The guarantee is in addition to, and does not diminish your statutory or legal rights.

Guarantor: Argos Limited
489 - 499 Avebury Boulevard
Central Milton Keynes
MK9 2NW