

# 32" HD Ready LED TV with DVD player

Installation & Operating Instructions - Please keep for future reference

# BUSH

 **dts**<sup>®</sup>  
TruSurround

**32/133DVDB**

**412/4205D**

**32/133DVDW**

**424/0031D**



**Important - Please read these instructions fully before installing or operating**

These instructions contain important information which will help you get the best from your television and ensure safe and correct installation and operation.

**For any help concerning set up and use of your TV please call the Customer Helpline: 0330 024 0805 (calls are charged at the standard rate of your network provider).**

Lines open: 8.30am - 6pm Monday to Friday and 9am - 5pm Saturday



# Important Guarantee Information

Congratulations on purchasing this television. We hope you have many years of trouble free enjoyment from your purchase.

Your product is covered under the manufacturers guarantee for 12 months from the date of purchase.

If you experience any difficulties with your TV, please refer to the 'Frequently asked questions' section in this user guide.

If you are still unable to remedy the issue, try resetting the TV to factory settings. (Details in the 'Settings menu' section of this user guide). Alternatively you can contact the helpline on the number below.

In the event that a fault is diagnosed, the helpline will arrange to collect the TV from your home or work address, return it to our service centre, repair the item and then return it to you.

If we believe we cannot offer a permanent repair, we will replace the item.

## Helpline Information

Telephone UK 0330 024 0805, ROI 01443 3940

Web support: [www.umc-uk.co.uk](http://www.umc-uk.co.uk)

The telephone opening hours are Monday to Friday 8.30am to 6pm, Saturday 9am – 5pm.  
Calls are charged at the standard rate of your network provider.

You must retain all packaging materials, in addition to your proof of purchase/receipt, as you will need these in the event of warranty/service support.

This guarantee is in addition to and does not affect your statutory rights.

If you need to call the helpline, you will need the following information.

1) Model Ref \_\_\_\_\_ (You can find this on the rear of the TV)

2) Date of purchase \_\_\_\_\_ (You can find this on your sales receipt)

3) Serial Number \_\_\_\_\_ (You can find this on the rear of the TV)

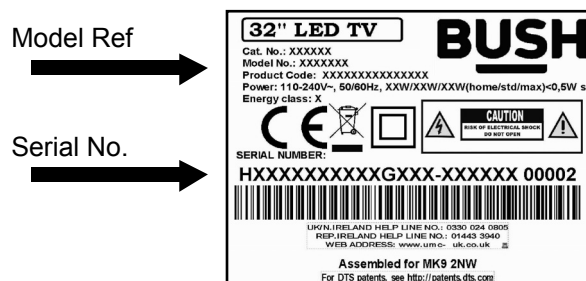

For any help concerning set up and use of your TV please call the Customer Helpline on page 3

# Important Safety Instructions

**IMPORTANT** - Please read these instructions. All the safety and operating instructions should be read before the appliance is operated.



## Warnings

- Television sets which weigh 20kg or more must be lifted and carried by at least 2 people.
- This television does not contain any parts that are serviceable by the user. In case of a fault, contact the manufacturer or authorised service department. Exposing the internal parts inside the TV may endanger your life. The manufacturer's guarantee does not extend to faults caused by repairs carried out by unauthorised third parties.

To prevent the spread of fire, keep candles or other open flames away from this product at all times



- To reduce the risk of fire, electric shock or damage to the TV, do not expose it to dust, rain or moisture. Never expose the TV to dripping or splashing and do not place objects filled with liquids on or near the TV.
- Do not connect any external devices (DVD player, games console etc) when the TV is switched on. Disconnect both the TV and device from the mains before connecting. Only switch appliances on when the connection process is complete.
- Do not place the television in a confined space and do not obstruct the ventilation openings at the rear of the television.
- When installing on a wall, ensure the TV is at least 5cm from the wall for ventilation.
- Always ensure that the TV's ventilation openings are not covered with items such as newspapers, table-cloths, curtains, etc.

## Safety

- Dispose of this television and any components including batteries in an environmentally friendly manner. If in doubt, please contact your local authority for details of recycling.
- For your safety, this appliance is fitted with a fused 3 pin mains plug. Should the fuse need to be replaced, ensure that any replacement is of the same amperage and approved with the BSI mark.
- Never try and replace the mains plug unless you have adequate qualifications and are legally authorised to do so. In the event that a replacement mains cable is required, contact the manufacturer for a suitable replacement.

- Never use the television if it is damaged in any way.
- Always place the television on a flat level surface avoiding anywhere which may be subject to strong vibration.
- The ideal distance to watch the television is approximately five times the length of the diagonal measurements of the TV screen. Ensure the television is not placed on top of the power cable as the weight of the television may damage the cable and cause a safety hazard.
- Never place mobile phones, speakers or any other device which may cause magnetic or radio interference, near the television. If interference is apparent, move the device causing the interference away from the television.
- To isolate the TV from the mains power, please use the power switch located on the side, underside or rear of the TV set.
- Ensure that the power switch on the unit and the mains plug are always easily accessible.

**WARNING:** Excessive noise when using earphones and headphones can cause loss of hearing.

- To clean your TV, wipe with a soft, dry cloth. If the surfaces are extremely dirty, use a soft cloth dipped in a soap and water solution or a weak detergent solution.
- Never use alcohol, paint thinner or benzene to clean this unit.
- Before using a chemically treated cloth, read the instructions that came with the cloth carefully.

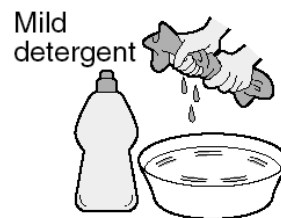

**CAUTION:** If water or other liquid enters the television through the display panel surface, a malfunction may occur.

## Packaging

- The safest way to transport your item is in the original box/packaging - please save your packaging for this.
- You will need the original box/packaging in the event of warranty/service repair or support. We are unable to carry out warranty/service if you are unable to package the item correctly.

# Important Safety Instructions

**IMPORTANT** - Please read these instructions. All the safety and operating instructions should be read before the appliance is operated.



## Important information regarding use of video games, computers, captions or other fixed image displays

The extended use of fixed image program material can cause a permanent "shadow image" on the LCD/LED panel, also known as "screen burn".

This "shadow image" can appear in the background during normal viewing. This type of irreversible LCD/LED panel deterioration can be limited by observing the following steps:

1. Reduce the brightness/contrast setting to a minimum suitable viewing level.
2. Do not display the fixed image for extended periods of time.
3. Turn the power off when not in use.

Examples of images that are more likely to cause "screen burn" are as follows (this is not an exhaustive list):

- TV channel logos: e.g. shopping channel logos and pricing displays - especially if they are bright and stationary. Moving or low-contrast graphics are less likely to cause ageing of the screen.
- Time displays.
- Teletext: Do not view a stationary page for a long period of time
- TV/DVD menus: e.g. listings of DVD disc content.
- Pause mode: Do not leave the TV in pause mode for long periods of time, e.g. when watching DVDs or videos.

**Important** - Once 'shadow image/screen burn' occurs, it will never disappear and is not repairable under warranty.

## TV Models with built in DVD players

CAUTION:

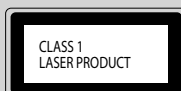

This unit is a class 1 laser product. This unit uses a visible laser beam which could cause hazardous radiation exposure if directed. Be sure to operate the player correctly as instructed.

When this unit is plugged into the wall outlet, do not place your eyes close to the openings to look into the inside of this unit.

Use of controls or adjustments or performance of procedures other than those specified herein may result in hazardous radiation exposure.

Do not open covers and do not repair yourself. refer servicing to qualified personnel.

**UK:** Waste electrical products should not be disposed of with household waste. Please dispose of the product at a designated collection point for recycling of WEEE. For your nearest facilities, please

## How do I dispose of this product?

see [www.recycle-more.co.uk](http://www.recycle-more.co.uk) or in store for details.



**ROI:** Waste electrical products should not be disposed of with household waste. Separate disposal facilities exist. Check with your local authority or retailer for recycling advice.

## Batteries

- Do not expose batteries to high temperatures, excessive heat, prolonged sunshine or fire as this may cause leakage, explosion or ignition. Observe the correct polarity when inserting batteries.
- Do not use different types of batteries together or mix old and new batteries.
- Dispose of batteries in an environmentally friendly way.
- Certain regions may regulate the disposal of batteries. Please consult your local authority.



# Trademarks

- HDMI, the HDMI logo and High-Definition Multimedia Interface are trademarks or registered trademarks of HDMI Licensing LLC.
- The “HD TV” Logo is a trademark of DIGITALEUROPE.
- The “HD TV 1080p” Logo is a trademark of DIGITALEUROPE.
- The DVB logo is the registered trademark of the Digital Video Broadcasting - DVB – project.
- Manufactured under license from Dolby Laboratories.
- Dolby and the double-D symbol are trademarks of Dolby Laboratories.
- Manufactured under license under U.S. Patent Nos: 5,956,674; 5,974,380; 6,487,535 & other U.S. and worldwide patents issued & pending. DTS, the Symbol, & DTS and the Symbol together are registered trademarks & DTS 2.0+Digital Out is a trademark of DTS, Inc. Product includes software. © DTS, Inc. All Rights Reserved.

# Contents

<b>Manufacturers Guarantee Information</b>	<b>3</b>
<b>Important Safety Instructions</b>	<b>4-5</b>
<b>Trademarks</b>	<b>6</b>
<b>What is included in the box</b>	<b>8</b>
<b>Attaching the stand</b>	<b>9</b>
<b>Detaching the stand and securing the TV to a wall</b>	<b>10</b>
<b>Wall mounting</b>	<b>11</b>
<b>Getting Started - Initial Set Up</b>	<b>12</b>
<b>TV Buttons and Input Source Menu</b>	<b>13</b>
<b>Remote Control</b>	<b>14</b>
<b>Connections</b>	<b>15-17</b>
<b>TV Menu Operation</b>	<b>18-25</b>
Channel Menu	18
Picture Menu	19-20
Sound Menu	21
Time Menu	22
System/Hotel Lock Menu	23
Setup Menu	24
<b>DVD Setup</b>	<b>25</b>
<b>7 Day TV Guide</b>	<b>27</b>
<b>USB Mode / Media Player</b>	<b>28</b>
<b>General Information</b>	<b>29-33</b>
Using your TV with a Sky digital set top box	29
Frequently Asked Questions	30-31
Technical Specifications	32-33



For DTS patents, see <http://patents.dts.com>. Manufactured under license from DTS Licensing Limited. DTS, the Symbol, & DTS and the Symbol together are registered trademarks, and DTS TruSurround is a trademark of DTS, Inc. © DTS, Inc. All Rights Reserved.

# What Is Included In The Box

Included with this TV are the following accessories:

1 x User Guide

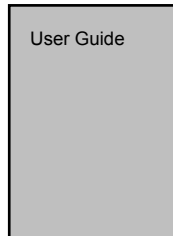

1 x Remote Control



1 x Quick Start Guide

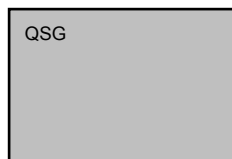

2 x AAA Batteries



1 x TV

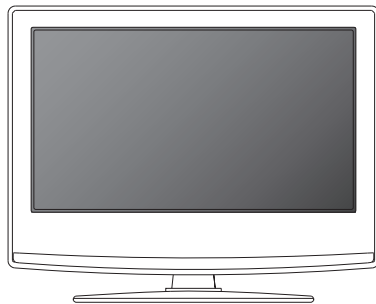

1 x Mini Component / YPbPr Cable



1 x RF Cable



1 x Stand Installation Pack

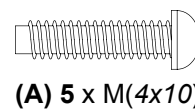

(A) 5 x M(4x10)

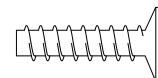

(B) 3 x ST(3.7x18)  
Counter Sunk

Please save your box/packaging as you will need this in the event of warranty/service repair or support. We are unable to carry out warranty/service if you are unable to package it correctly. The safest way to package your item in the event of warranty/service repair is in its original box/packaging.



# Attaching The Stand

To complete the stand installation you will require a cross head screw driver.

The Stand Installation pack comes with 2 sets of screws.

**fig 1)** Attach the stand neck to the rear of the TV set.

**fig 2)** Secure the neck to the TV using the (A) 5 x M (4x10) screws provided.

**fig 3)** Attach the stand base to the neck.

**fig 4)** Secure the base to the neck using the (B) 3 x ST (3.7x18) counter sunk screws provided.

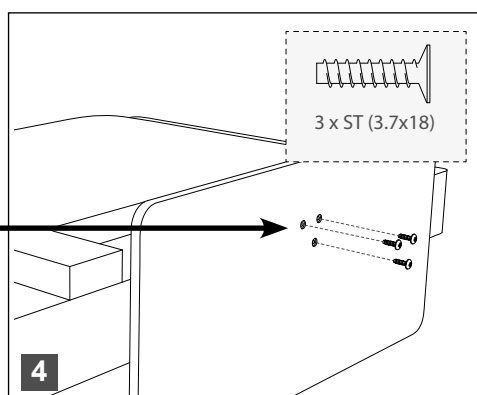
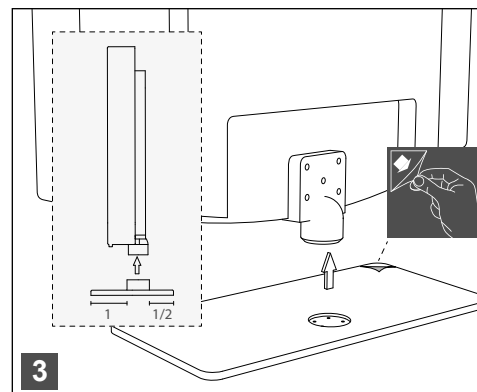
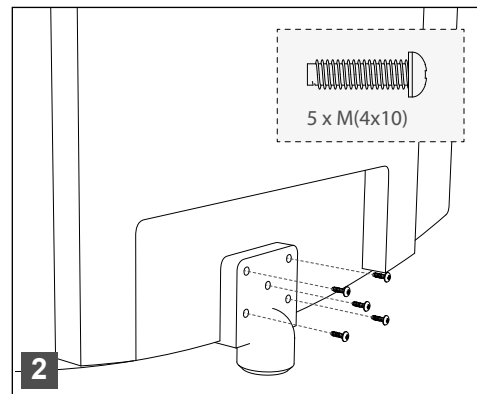
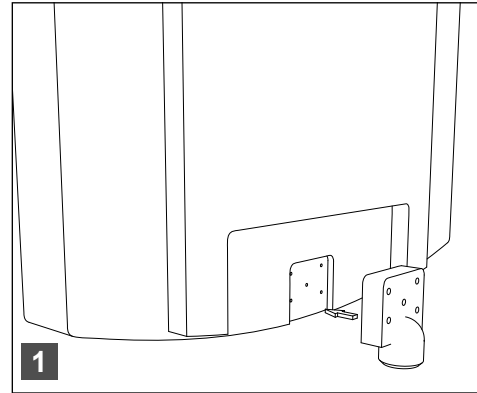
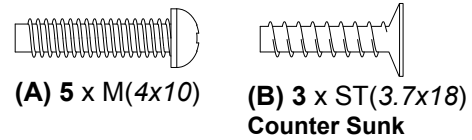

#### HELPFUL ADVICE FOR FIRST TIME STAND INSTALLATION

When securing the self-tapping screw/s into the base of the TV (on first installation) the screw/s may be naturally tight as they create a thread in the plastic.

- Ensure the cross head screw driver tip fits correctly into the head of the screw and that it is not too big or small.
- Screw in all screws individually and partially before tightening all of the screws fully.
- If the screws become very tight try loosening and re-tightening, this will continue the process of creating the thread.

# Detaching The Stand And Securing The TV To A Wall

## Detaching the Stand

To detach the stand please remove the **5** screws highlighted then remove the stand neck and base from the rear of the TV set.

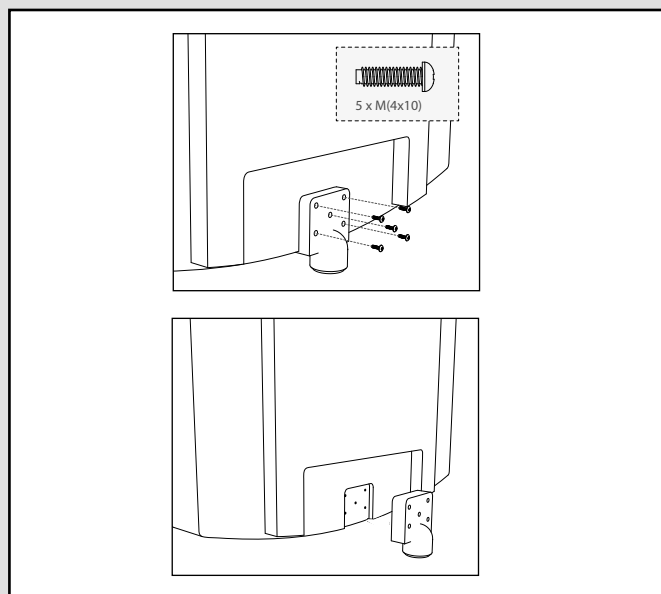

## Securing the TV to a Wall

For maximum security in the home, when using a TV with its stand, anti-tip straps should be fitted. These are available from supermarket websites and other websites and are an easy, inexpensive and effective way of ensuring your TV stays safely upright. Straps are designed to be attached to the rear of the TV and then tethered to the wall or the furniture the TV is stood on, these are fitted as follows.

**Note** - Please ensure that children do not climb on the TV set.

**A)** Using one or both of the top wall-mounting holes and screws fasten one end of the fastening cord/s to the TV. (the screws are already supplied in the wall mounting holes)

**B)** Secure the other end of the fastening cord/s to your wall. (you will need screws/fixings suitable for your wall type - available separately from most DIY stores).

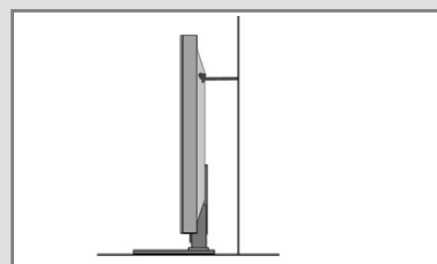
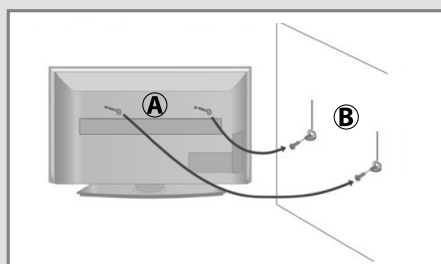

The Royal Society for the Prevention of Accidents is urging people to take care with flat-screen televisions.

RoSPA stated in 2010 that "Toddlers are particularly at risk of pulling flat-screen televisions on to themselves. They are unsteady on their feet and are attracted by colourful television images."

The risk is increased as televisions become lighter.

# Wall Mounting

**IMPORTANT** - Before drilling any holes in the wall ensure you are not drilling where there could be any electric wires, water or gas pipes.

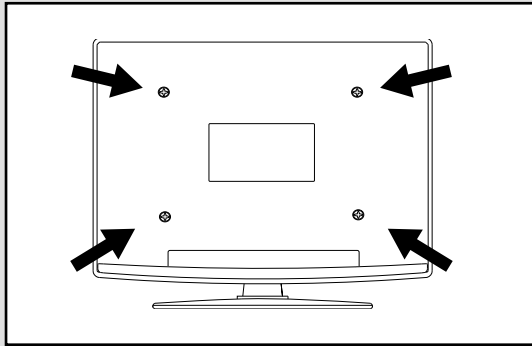

1) Remove the four screws located at the back of the TV set.

2) The wall mount can now be easily attached to the mounting holes, located on the back of the TV, using the same four screws removed.

**IMPORTANT** – If wall mounting this TV, only use the screws already provided in the wall mounting holes. Using other screws which are longer could cause irreparable damage to internal parts.

For optimum viewing, if wall mounting the TV higher than eye level, the TV should be tilted downwards so that the TV's screen is 'face on'.

See **fig 1** and **2** below.

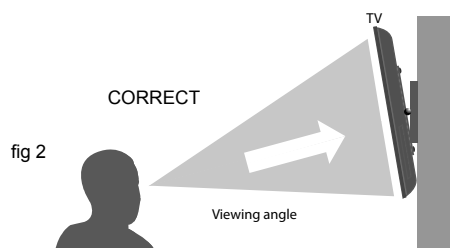
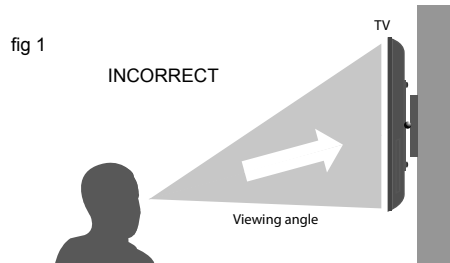

For VESA wall mounting information please refer to the Technical Specification page.

# Getting Started - Initial Set Up

1) Using the RF cable supplied, connect the TV to the TV Aerial wall socket (Fig A).

Connect the power cable to the Electrical outlet (Fig B).

2) Switch on the television using the power on/off switch located on the side, underside or rear of the TV set.

3) Insert the batteries supplied into the Remote control and press the standby button to power on the TV.

4) You will now be welcomed with the initial set-up screen. If it does not appear, on the remote control, please press [MENU] then 8-8-8-8 and the menu will appear. Press OK on the remote control and tuning will start.\*

5) After tuning the following screen will appear.\*

If you are missing channels, the reason for this is likely to be signal strength, you should consider connecting a signal booster and re-tuning the TV.

## Important

As part of our ongoing development to reduce power consumption, we have added an extra function to this Television called 'Home Mode' (you will see this during the first time installation set up). Power consumption using the Home Mode function is approximately 25% lower than some other modes. The picture brightness is reduced using the Home Mode function. If this function is not suitable for your viewing environment, you can select other modes as necessary. (Please note, 'Store mode' is for optimum default picture settings, however, power consumption is approximately 25% higher than 'Home Mode').

Please refer to the user guide section 'Picture settings' in order to change the mode to one that maybe more suitable for your environment. There is also a shortcut button on the remote control called 'P-Mode' should you wish to change to another mode.

1

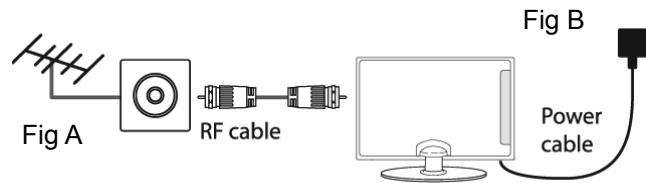

2

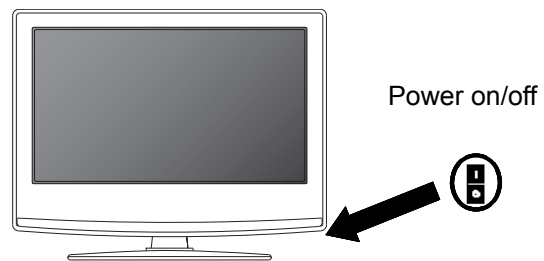

3

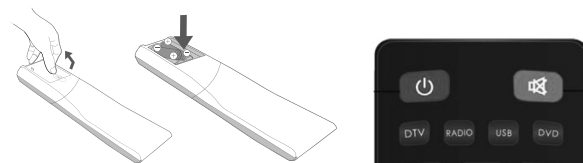

4



5

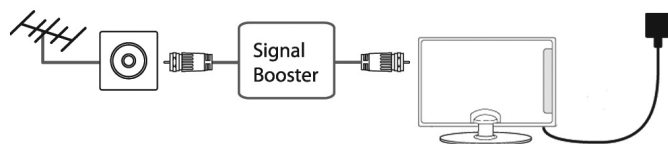
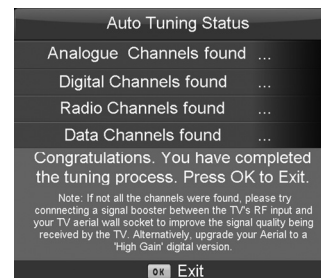

\*Screen shots/images are shown for illustration purposes only and may change dependent on *model/region*.

# TV Buttons & Source Menu

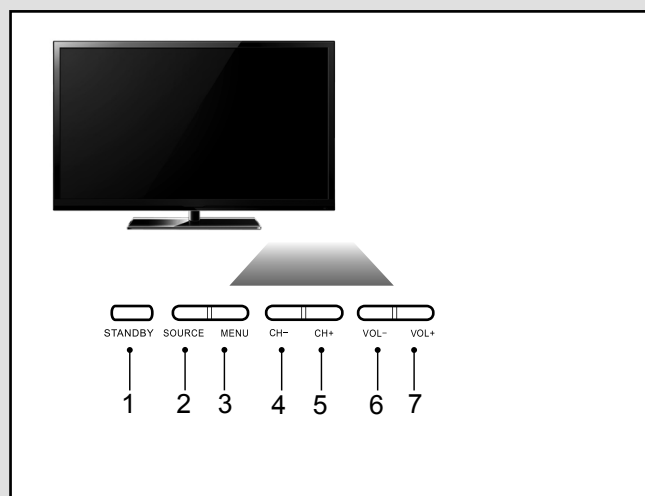

1. Standby Power On/Off
2. Displays the input source menu
3. Displays Menu/OSD
4. Programme/Channel down and menu down
5. Programme/Channel up and menu up
6. Volume down and menu left
7. Volume up and menu right

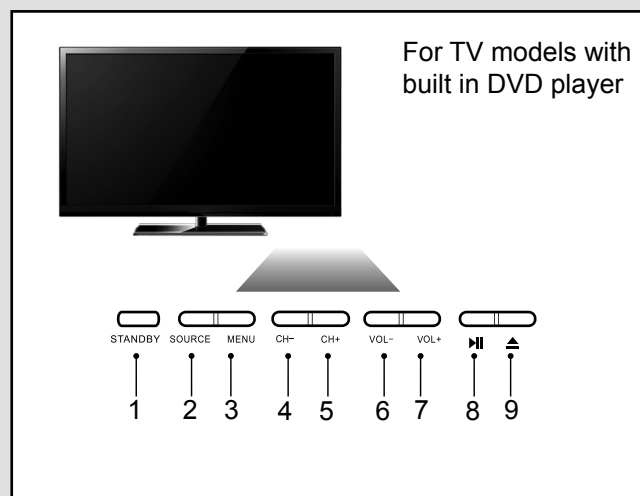

1. Standby Power On/Off
2. Displays the input source menu
3. Displays Menu/OSD
4. Programme/Channel down and menu down
5. Programme/Channel up and menu up
6. Volume down and menu left
7. Volume up and menu right
8. Play/Pause DVD
9. Stop/Eject DVD

## Choosing Mode Input/Source

To switch between the different input/connections.

A) Using the buttons on the remote control:

- 1) Press [SOURCE] - The source menu will appear.
- 2) Press [V] or [^] to select the input you require.
- 3) Press [OK].

B) Using the buttons on the Television:

- 1) Press [SOURCE].
- 2) Scroll up / down using CH+ / CH- buttons to the input/source you require.
- 3) Press Vol+ to change input/source to the one selected.

**For further information on input/connections please view 'Connections' pages.**



An example of the 'Input Source' menu (will vary by model)

# Remote Control

## Viewing remote control - TV

1. STANDBY
2. MUTE
3. DTV
4. RADIO
5. DVD
6. USB
7. NUMBER BUTTONS
8. TV GUIDE
9. ↶ - To return to the previous channel viewed
10. P.MODE - Scrolls through picture mode options
11. VOL ▲/▼
12. CH ▲/▼
13. S.MODE - Scrolls through sound mode options
14. FAV - To display favourites menu
15. MENU
16. EXIT
17. (▲/▼/◀/▶/OK) - Allows you to navigate the on-screen menus and adjust the system settings to your preference
18. SOURCE/AV
19. INFO
20. ASPECT
21. SLEEP
22. SUBTITLE
23. DISPLAY
24. TEXT
25. TEXT HOLD
26. TEXT/DVD ZOOM
27. PWR
28. DVD MENU
29. REC LIST
30. GOTO
31. A-B
32. REPEAT
33. ANGLE/3D - Change to 3D mode

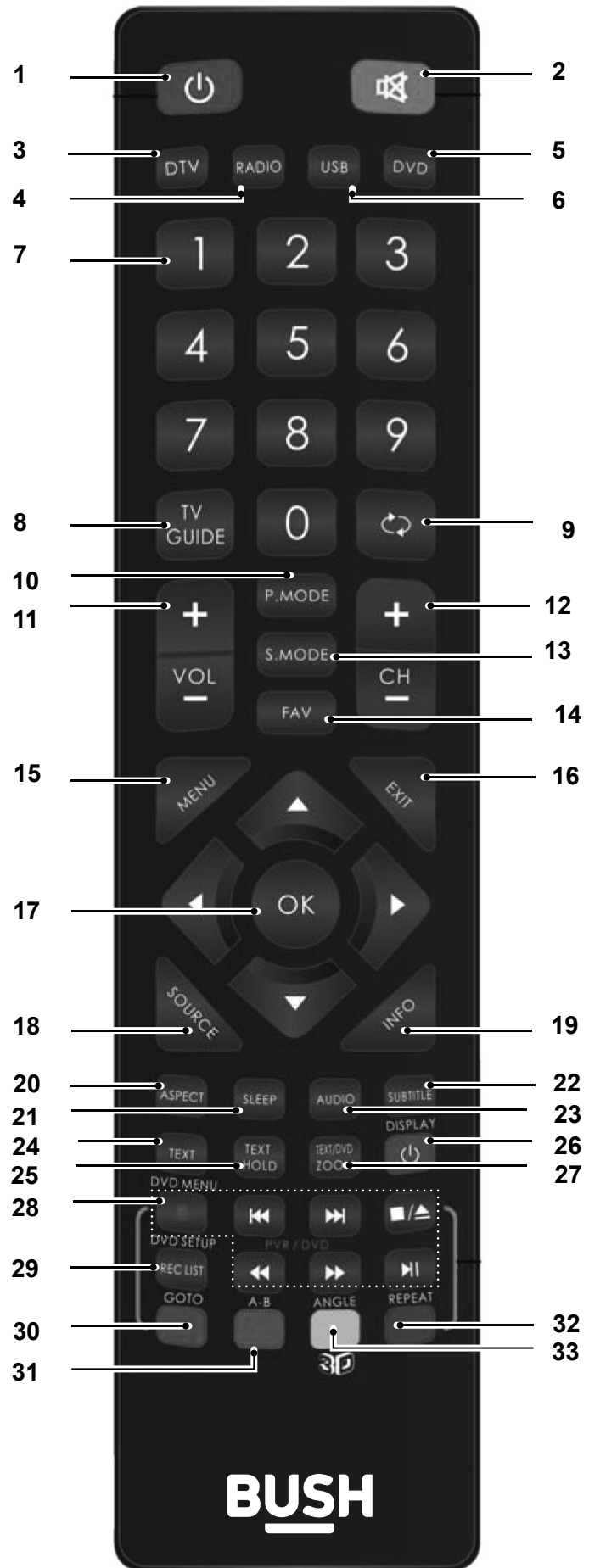

- ⊙ 27. TEXTZOOM/DVD ZOOM
- ⊙ 28. DVD Menu/Record
- ⏮ - To restart the current chapter
- ⏭ - To advance forward to the next chapter
- ⏪ - To stop/eject Disc  
(hold for 4 seconds to eject disc)
- ⏮ - To play in fast rewind mode
- ⏭ - To play in fast forward mode
- ⏸ - To play/pause

- ⏮ 29. REC LIST
- ⏮ 30. GOTO
- ⏮ 31. A-B
- ⏮ 32. REPEAT
- ⏮ 33. ANGLE/3D - Change to 3D mode

- ⊙ For Models with Integrated DVD players
- ▶ For Models with PVR Function
- ⊙ For Models with USB Playback
- ▶ For Models with 3D Feature

# Connections

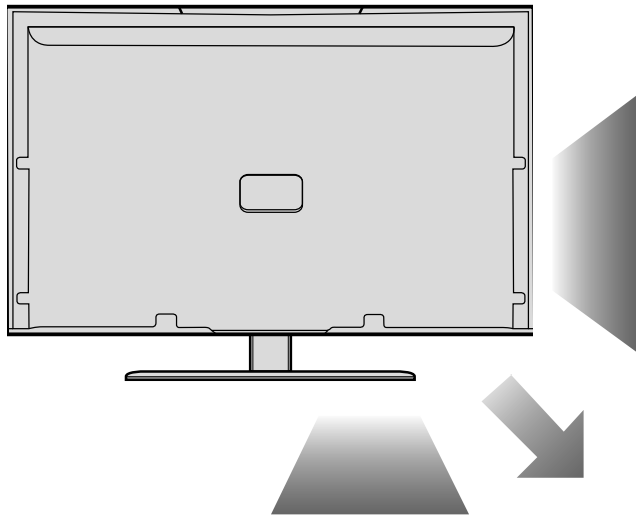

- |    |                 |                         |   |
|----|-----------------|-------------------------|---|
| 1  | COAX in         | Digital Coax output     | - |
| 2  | HDMI 1          | HDMI input              |   |
| 3  | HDMI 2          | HDMI input              |   |
| 4  | SCART           | SCART input             |   |
| 5  | VGA/PC AUDIO IN | 3.5mm PC audio input    | - |
| 6  | VGA/PC          | VGA/PC input            |   |
| 7  | RF IN           | RF / TV Aerial input    |   |
| 8  | AV IN           | Video input             |   |
| 9  | R/L AUDIO IN    | Component Audio input   |   |
| 10 | HDMI 3          | HDMI input              |   |
| 11 | USB             | USB input               |   |
| 12 | COMPONENT (HD)  | Component input (YPbPr) |   |
| 13 | CI CARD IN      | Common Interface module |   |
| 14 | EARPHONE        | Earphone socket         |   |

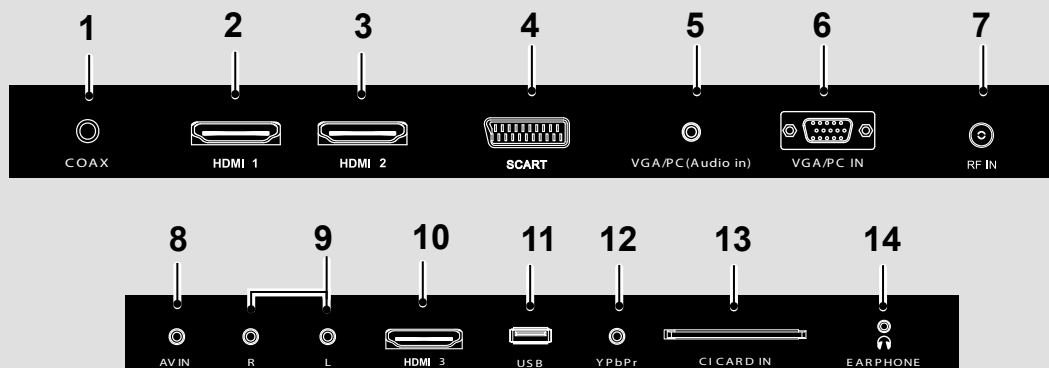

# Connections

## Connecting a Camcorder, Camera or Games Console

Source should be set to Composite/AV

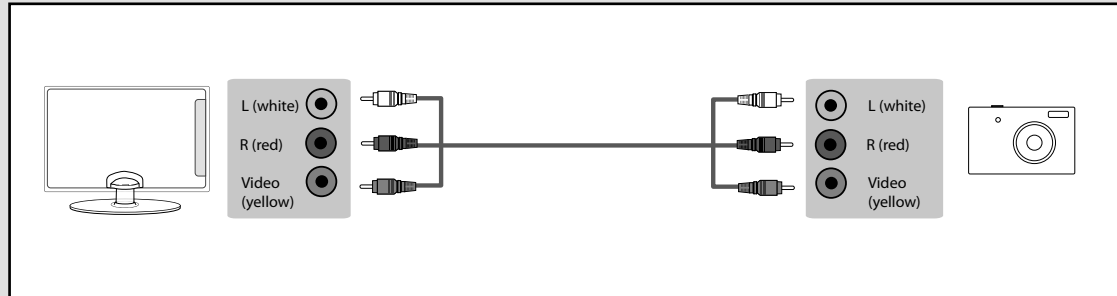

## Connecting a DVD Player/Recorder, Video Recorder or Cable/Satellite Box

TVs Source should be set to SCART

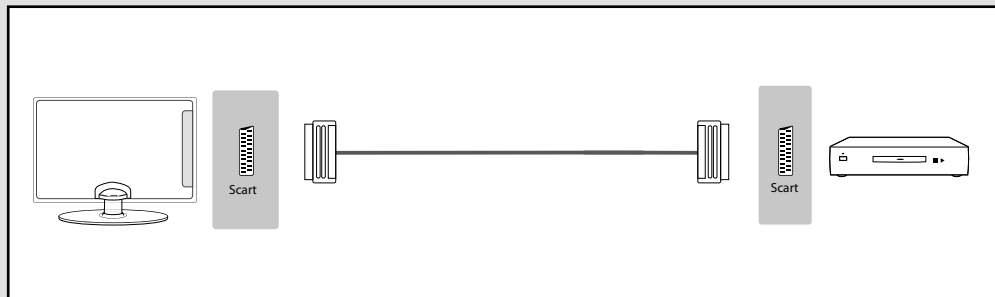

## Connecting a High Definition (HD) Device Option 1 - via HDMI to HDMI cable

A HDMI cable can output both video and audio and enables you to enjoy digital-quality video and audio with minimal loss of quality.

TVs Source should be set to the corresponding HDMI Port (HDMI 1, HDMI 2, etc)

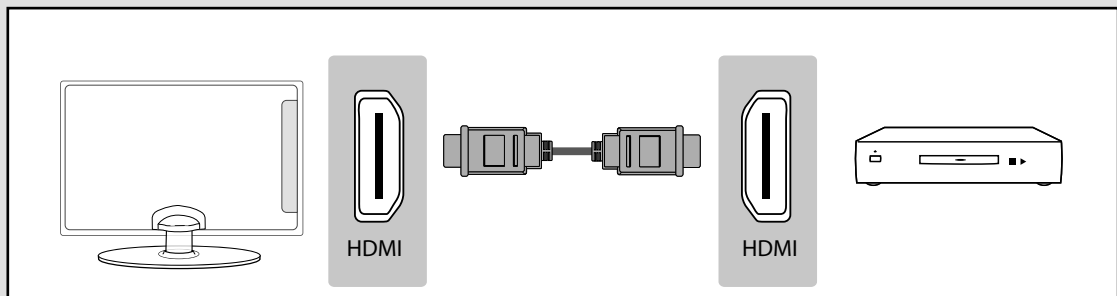

**Note:** This model TV can not be used as a PC/laptop monitor via HDMI input. The HDMI Input is provided to view digital content with compatible external devices.



# Connections

## Connecting a High Definition (HD) Device Option 2 - via Component cable

If you are supplied with a cable from the device which has RED, GREEN, BLUE, RED & WHITE connectors you must connect via Component (for picture) and by phono cable (for sound).

TV Source should be set to Component/YPbPr.

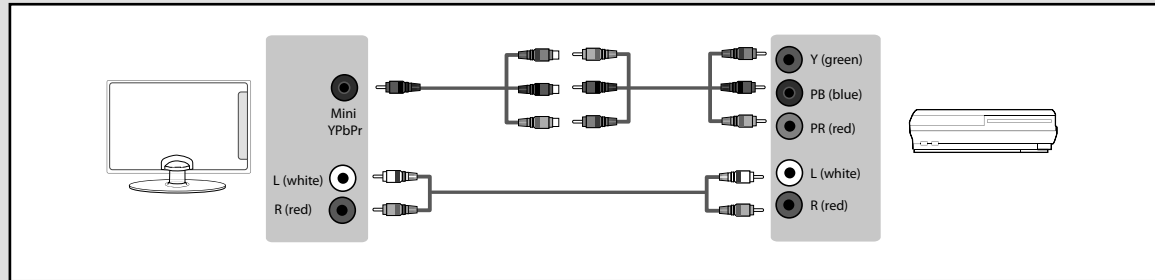

## Connecting to a device with VGA/PC output (Laptop or Desktop Computer)

Source should be set to VGA/PC

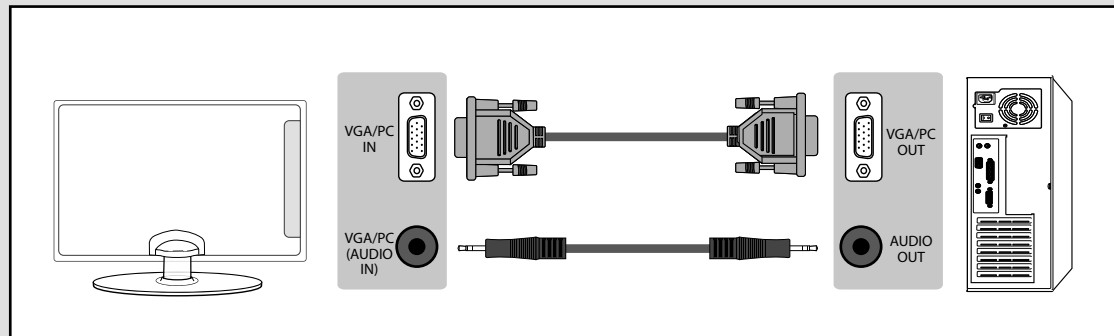

## Connecting to an external audio device (Amplifiers, Surround Sound, Sound Bars etc)

When connecting via the TV's 3.5mm Earphone output, this will disable the TV speakers.

There are two options to connect a device via the 3.5mm Earphone Output.

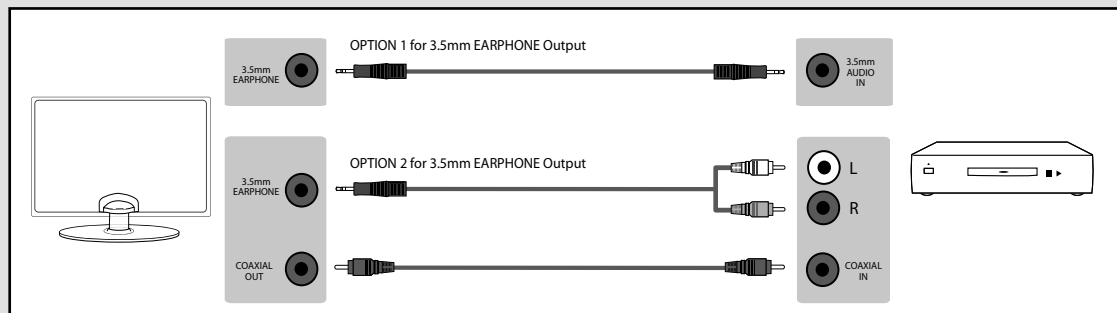

**Note:** Connecting cables are shown for example only and may not be included. Please check 'What Is Included In The Box' page.

# Channel Menu



## Auto Tuning

Allows you to retune the television for all digital channels, digital radio stations and analogue channels.

## Analogue Manual Tuning

Allows you to manually tune your analogue signal

## Freeview Manual Tuning

Allows you to manually tune your digital signal

## Channel Edit

Allows you to delete, move, skip and add favourite channels.

## Schedule List

Lists your programme reminders

## Signal Information

Displays signal strength information

## CI Information

Pay per view services require a “smartcard” to be inserted into the TV. If you subscribe to a pay per view service the provider will issue you with a ‘CAM’ and a “smartcard”. The CAM can then be inserted into the COMMON INTERFACE PORT (CI Card In).



To access this menu, press [MENU] button on the remote control. To enter a menu press [OK]

If you wish to make changes to any of the default settings, use the scroll ▲▼▶◀ buttons. To confirm any settings press [OK] button.

To exit this menu at anytime, press [EXIT] button.



Tip: If you do not press any buttons for 30 seconds, the menu will automatically exit. You can change the length of time before the menu exits automatically - see ‘Menu Duration’ section.

# Picture Menu

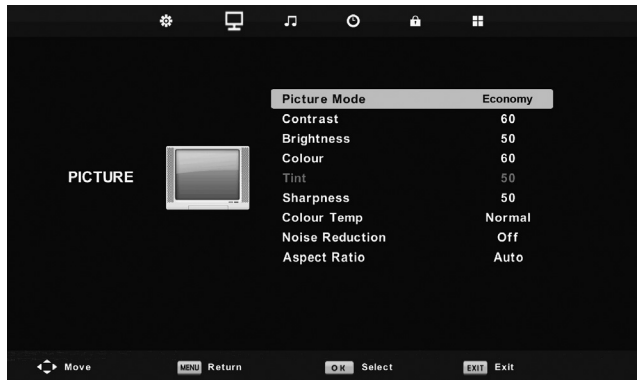

To access this menu, press [MENU] button on the remote control and scroll right.  
To enter a menu press [OK]

If you wish to make changes to any of the default settings, use the scroll ▲▼▶◀ buttons. To confirm any settings press [OK] button.

To exit this menu at anytime, press [EXIT] button.

## Picture Mode

- Dynamic - Recommended settings for fast moving pictures
- Standard - Default settings
- Mild - Set to be lighter in colour and less bright
- Personal - Lets you manually alter all the settings
- Economy - Power saving mode which reduces the energy used by up to 25% (by reducing the power to the LED/LCD panel). In Economy mode, the TV will switch itself to Standby mode after 3-5 hours in the event that the TV buttons or remote control buttons are not pressed (change the picture mode to another setting to de-activate this function)

## Contrast

Switch the balance between black and white

## Brightness

Increase or decrease the brightness of the picture

## Colour

Increases the colour from black and white

## Tint

Lets you increase or decrease the level of tint within the picture

## Sharpness

Increase or decrease the sharpness of the picture

## Colour Temperature

- Normal - Default settings
- Warm - Increases red within the picture
- Cool - Increases blue within the picture

## Noise Reduction

- Off - Turns noise reduction off
- Low - Minor system adjustment
- Middle - Medium system adjustments
- High - Maximum system adjustments
- Default - Default settings

# Picture Menu

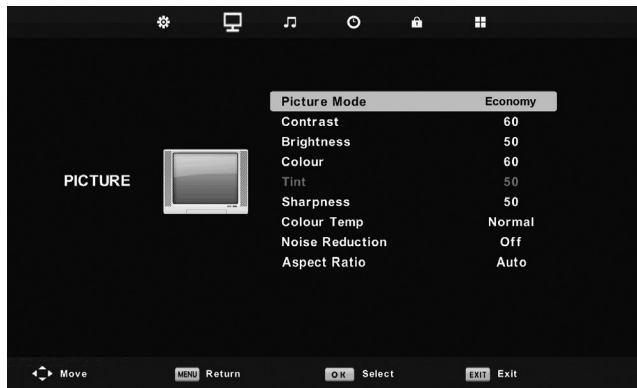

## Aspect Ratio

Within the UK the picture format varies depending on the channel/broadcast. There are a number of different options to best meet your needs

- **Auto** - Automatically displays the best picture format. So the picture is in the correct position. May have black lines at the top/bottom and/or sides.
- **Original** - Will display the picture from the broadcaster without any change
- **4:3** - Displays the 4:3 picture in its original size. Side bars are shown to fill the 16:9 screen

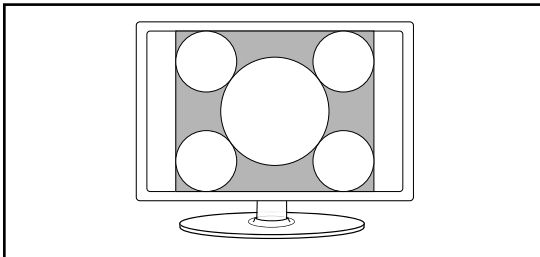

- **16:9** - Fills the screen with a regular 16:9 signal and 4:3 will stretch to fill the screen

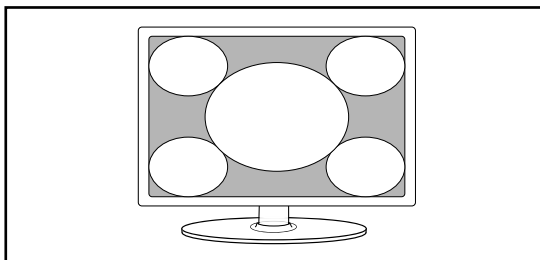

- **14:9** - Displays the 14:9 picture in the correct proportion. As a result bars are shown on the screen

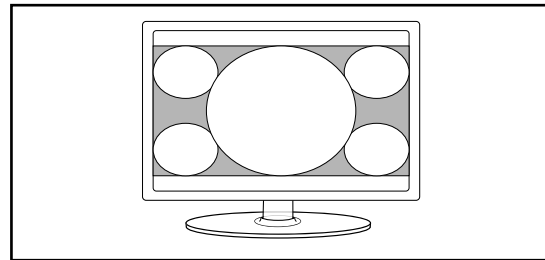

- **Zoom** - The picture is the correct proportion but zoomed in to fill the screen

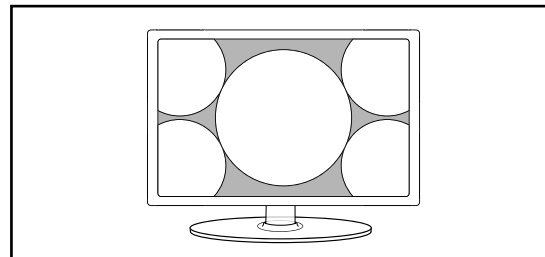

# Sound Menu

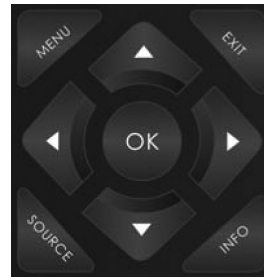

## Sound Mode

- Standard - Default settings
- Music - Emphasises music over voices
- Movie - Provides live and full sound for movies
- Sports - Emphasises sound for sports
- Personal - Selects your personal sound settings

## Treble

To adjust the amount of high frequency within the sound

## Bass

To adjust the amount of low frequency within the sound

## Balance

To switch the sound between the left and right speakers

## Auto Volume Level (AVL)

When 'on' is selected, the volume will stay at a constant level regardless of input/source

## Surround Sound

- Off - Off
- TruSurround HD - TruSurround HD™ creates an immersive, feature-rich surround sound experience from two speakers, complete with rich bass, high frequency detail and clear dialog

## Digital Output

- Off - Off
- Auto - Selects the best settings automatically
- PCM - Select this option if you are connecting to a Stereo Hi-fi via coax cable (Pulse-code modulation (PCM) is a digital representation of an analogue signal)

## Audio Description

This allows the user to increase and decrease the AD (Audio Description) volume level.

(Audio Description is a service available on certain programmes. It provides a description of what is happening during the selected programme for a person who is visually impaired)

## Audio Delay

Enables the user to adjust setting to sync picture and audio

**Tip:** Treble and bass levels can only be adjusted when the sound mode 'Personal' is selected.



For DTS patents, see <http://patents.dts.com>. Manufactured under license from DTS Licensing Limited. DTS, the Symbol, & DTS and the Symbol together are registered trademarks, and DTS TruSurround is a trademark of DTS, Inc. © DTS, Inc. All Rights Reserved.

# Time Menu



## Clock

Shows the date and time

## Off Time

Allows you to set a specific time for your TV to turn off

## On Time

Allows you to set a specific time for your TV to turn on, the channel it will then display, the source it will be on and also the volume. This function can then be toggled to repeat every day or a certain day.

## Time Zone

Change your current time zone

## Sleep Timer

Lets you set the sleep timer so the television automatically switches off after a set amount of time.  
Off -> 10min -> 20min -> 30min -> 60min -> 90min -> 120min -> 180min -> 240min

## Auto standby

Set Auto standby between 3 hours, 4 hours and 5 hours ( to turn off this function you must exit Home Mode in the Picture Menu)

## OSD Timer

Lets you adjust the amount of time the On Screen Menu stays on the screen before disappearing

To access this menu, press [MENU] button on the remote control and scroll right.  
To enter a menu press [OK]

If you wish to make changes to any of the default settings, use the scroll ▲▼▶◀ buttons. To confirm any settings press [OK] button.

To exit this menu at anytime, press [EXIT] button.

# System/Hotel Lock Menu

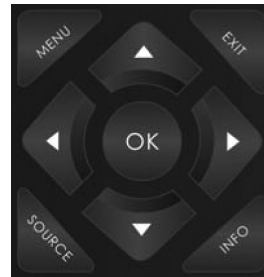
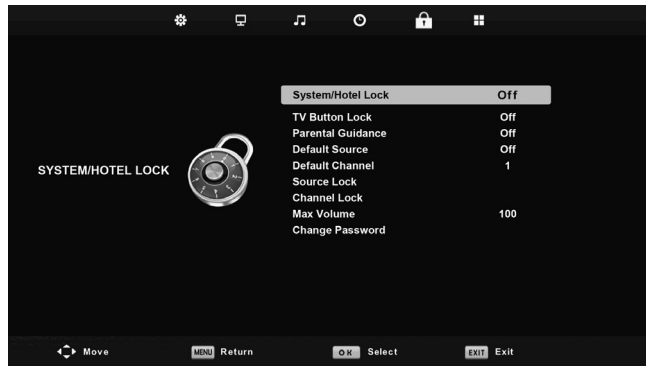

## System/Hotel Lock

Allows you to lock or unlock the menu. You will be asked to enter a 4 digit password use the ◀ button to quit the password input. Use the ▶ button to clear. Default password is 0000

## TV Button Lock

Allows you to lock the buttons on the side of the TV set

## Parental Guidance

Allows you to set the rating to block certain content based on age information

## Default Source

Allows the user to set the default source. The default source is the source the TV starts on when first switched on

## Default Channel

Allows the user to set a channel as the default channel on the Digital source. The default channel is the channel the TV starts on when first switched on

## Source Lock

Allows you to lock the source menu

## Channel Lock

Allows you to lock certain channels manually

## Max Volume

Allows you to adjust and set the maximum volume

## Change Password

Allows you to change the password

To access this menu, press [MENU] button on the remote control and scroll right.  
To enter a menu press [OK]

If you wish to make changes to any of the default settings, use the scroll ▲▼▶◀ buttons. To confirm any settings press [OK] button.

To exit this menu at anytime, press [EXIT] button.

# Setup Menu

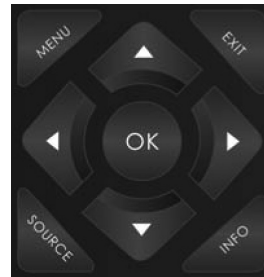
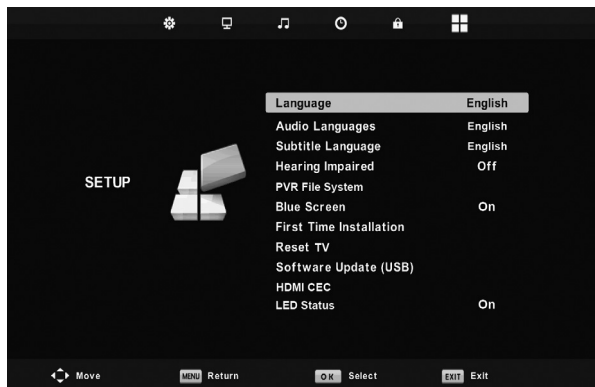

## Language

Allows you to change the language of the menu

## Audio language

Allows the user to change the audio language

## Subtitle Language

Allows the user to change the subtitle language

## Hearing Impaired

This allows the user to turn on the Hearing Impaired function, this produces subtitles on the screen which provide a description of what is happening during the selected program.

## PVR File System

Allows you to view the format and performance of a USB key

## Blue Screen

Changes the background when there is no input between clear and a blue background (Only available on some sources)

## First Time Installation

Allows you to retune the television for all digital channels, digital radio stations and analogue channels

## Reset TV

This resets the menus to factory settings and will erase all TV channels stored on the television

## Software Update (USB)

This menu lets you install the new software/firmware onto the television. Further details of how to do this will be issued with the firmware. Contact the helpline or refer to the 'product support' section of the website

## HDMI CEC (Consumer Electronic Control)

Allows HDMI devices to control each other and allows the user to operate multiple devices with one remote control. (only available with compatible devices)

## LED Status

Allows the user to switch the LED Power indicator light ON or OFF, when the TV is being operated. (When this option is set to OFF the LED Power indicator light will flash when the remote control is used)



# DVD Setup

Applies to models with built in DVD players

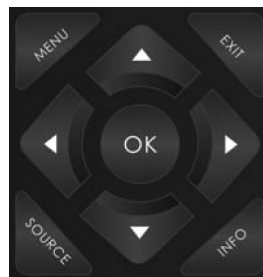
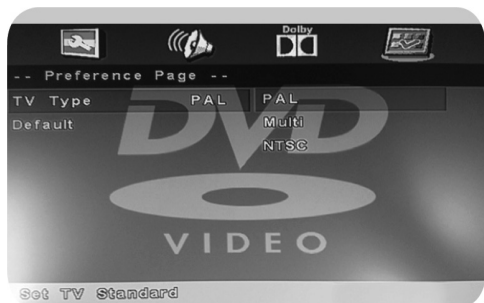

**TV Display** - Choose from the following options

<b>4:3 Pan Scan</b>	PS Traditional picture format, often used on old film
<b>4:3 Letter Box</b>	LB Traditional picture which has been adapted for widescreen
<b>Wide</b>	16:9 Widescreen picture format

**Speaker Setup** - Choose from the following options

<b>LT/RT</b>	Converts from multi-channel sound to mono
<b>Stereo</b>	Converts from multi-channel sound to Stereo

**Dual Mono** - Choose from the following options

<b>Stereo</b>	Outputs 2 channels of sound both left and right
<b>Mono L</b>	Outputs left side sound
<b>Mono R</b>	Outputs right side sound
<b>Mix Mono</b>	Outputs a single channel of sound but mix between right and left

**Dynamic Range** - This is the difference between the quietest and loudest sounds. This setting works only with DVD discs recorded in Dolby digital.

<b>Full</b>	Set this to listen with the range recorded on the disc
<b>3/4</b>	Set this to listen with a range equivalent to a normal television
<b>1/2</b>	Set this to listen with a smaller difference between the maximum and minimum volume
<b>1/4</b>	Set this to listen with a smaller difference between the maximum and minimum volume
<b>Off</b>	Set dynamic range to off

**TV Type** - Choose from the following options

<b>PAL</b>	For discs from UK/Europe, Asia, Australia etc
<b>Multi</b>	For both NTSC and PAL
<b>NTSC</b>	For discs from North America, Japan etc

**Default** - Choose from the following options

<b>Reset</b>	Resets all options in the 'DVD setup' menu back to the default settings
--------------	---

Tip: This TV/DVD player is pre-set to play Region 2 DVDs. In the event you wish to use the TV/DVD in another country that uses different region discs, please visit [www.umc-uk.co.uk](http://www.umc-uk.co.uk). Select 'Product Support', 'Changing Region'.



# 7 Day TV Guide

TV Guide is available in Digital TV mode. It provides information about forthcoming programmes (where supported by the freeview channel). You can view the start and end time of all programmes and on all channels for the next 7 days and set reminders.

1) Press [TV GUIDE]. The following 7 Day TV Guide will appear.

7 Day TV GUIDE				
3 ITV - The Jeremy Kyle Show		Entertainment		
09:25 - 10:30 10 Dec 2014				
Jeremy Kyle deals with more dilemmas, fiery confrontations and topical issues all in front of a studio audience. [S]				
10 Dec 2014 09:46:20		10 Dec 2014		
	Now	10:15	10:45	11:15
1 BBC ONE Oxford	Fake ...	Homes Under the Hammer	Claimed and Sh...	Oxfor...
2 BBC TWO	Great ...	Close Calls: On...	See Hear	BBC News Daily ...
3 ITV	The Jeremy Kyle Show	This Morning	...	This Morning
4 Channel 4	Frasier	Kirstie's Handmade Christmas	Jamie's 15 Min...	Come ...
5 Channel 5	The Wright Stuff			...
6 ITV2	Royal Pains	The Chase	All Star Family...	
7 BBC THREE	This Is BBC Three			
● Record	● Remind	● Prev Day	● Next Day	
◀▶ Move View	Info Details	EXIT Exit	OK Watch / Record / Remind	

2) Navigate through the menu using ▲▼▶◀

You can now:

Record a programme by pressing RED (USB device must be connected)

Set a reminder by pressing GREEN

View a previous day by pressing YELLOW

View the next day by pressing BLUE

3) Press [EXIT] to exit the 7 day TV Guide.

# USB Mode / Media Player

USB mode offers playback of various different types of content that you have saved on your USB Memory Stick.

On switching to USB source the menu screen will appear. The content will be divided into Photo, Music, Movie and Text based on file type.

1) You can navigate through the menus using the scroll ▲▼▶◀ buttons. To confirm the item you wish to play/view press [OK] button.

2) Select the drive you require.  
(If your drive only has 1 partition you will only see 1 item).

3) You can now access the item. Press OK to view.

4) While viewing you control the item using (Fig A) or by pressing (i) and using ▲▼▶◀ and (OK)

Tip: If you experience a playback issue, please ensure the files being used are the correct format (example - the picture plays but no sound) See technical specification page for compatible file types

1)

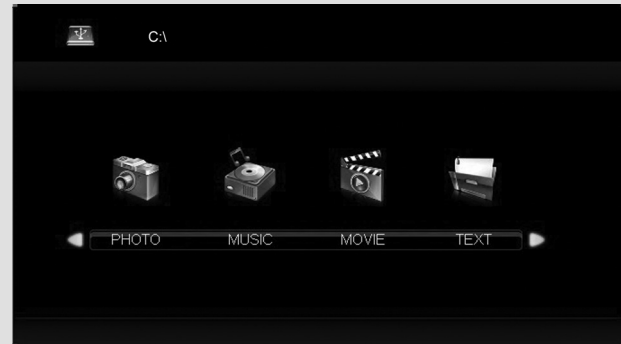

2)

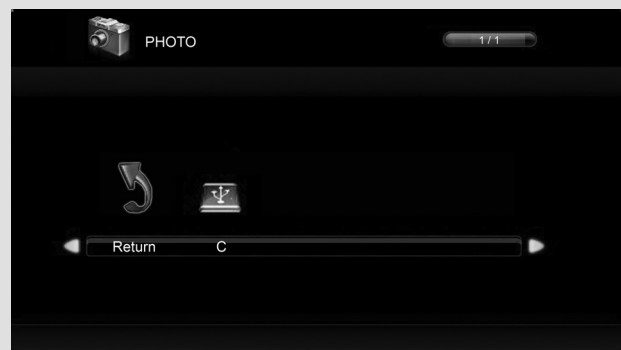

3)



4)



Fig A



# Using Your TV With a Sky Digital Set Top Box

## Option 1) Connecting your TV to your Sky box (when both the TV and Sky Box are located in the same room)

Depending on your Sky Box & TV model, connect either by SCART or HDMI cables (available separately)

If connecting by SCART, select the 'Input source' on the TV as SCART. If your TV model does not have SCART, please refer to the 'Connections' pages in this user guide for alternative ways to connect.

If connecting by HDMI, select the 'Input source' on the TV as HDMI (if the TV has more than 1 HDMI port, ensure you select the input source to match the HDMI numbered port on the rear of the TV)

If you wish to use your Sky remote to operate the TV's functions, you will need a Sky remote control (Revision 9 or later) and you will need to program a 4 digit code into it. See bottom of this page.

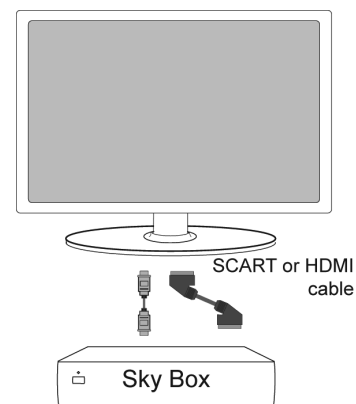

## Option 2) Connecting your TV to your Sky box (when your Sky box is located in a different room to the TV)

Please note, if you are adding a 'Magic Eye/TV Link' to your system so that you can use your Sky remote control to change the Sky channel in the room where the 2nd TV is located, please refer to the instructions included with the TV link/magic eye in order to ensure the RF or RF2 output on your Sky box is powered on. (The red LED light on the TV link/magic eye will light up if the RF / RF2 output is correctly set up) If you do not have the instructions that came with the TV link/magic eye, instructions on how to do it can be found on our website.

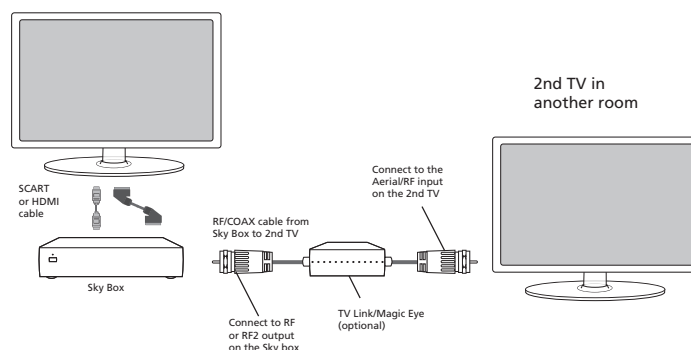

- 1) To tune the TV to the Sky box, on the 2nd TV, select the 'Analogue' input source.
- 2) Select the channel that you wish to store the Sky box/channel on. (If you do not use channels 1-5 because you no longer have analogue terrestrial channels after digital switchover, you may choose to select channel 1 to store the Sky box/channel, if you still have and use analogue channels 1-5, you may for example decide that channel 6 is the best option for you)
- 3) Press the corresponding number on the remote control to select the desired analogue channel chosen as per point 2 above.
- 4) On the TV remote control, press Menu. Now navigate through the menus to select Manual Tuning or Analogue Manual Tuning (refer to the Tuning/Channel menu section of this user guide if necessary)
- 5) Manually tune in the channel (usually, the Sky box is at a frequency between 800Mhz and 850Mhz) once the Sky box/channel is found, press 'OK' to store it. If you wish to use your Sky remote to operate the TV's functions, you will need a Sky remote control (Revision 9 or later) and you will need to program a 4 digit code into it.

*If you wish to use your Sky remote to operate the TV's functions, you will need a Sky remote control (Revision 9 or later) and you will need to programme a 4 digit code into it. Please see below.*

## Using a Sky Remote or a Universal Remote to operate your TV

**Sky Remote Control** - If you wish to use your Sky remote to operate the basic functions of your TV, you need to program a 4 digit code into it. Please note - you will need a Sky Revision 9 remote control (or later). If you wish to upgrade/replace your existing Sky remote control to the latest version, you can do so on our website.

**Universal Remote Control** - If you wish to use a Universal remote control to operate your TV, please refer to the website for a full list of codes. (Please note we only have codes for One for All branded remote controls, if you have an alternative brand of Universal remote, please refer to the manufacturer for the code.)

# Frequently Asked Questions

General	I would like to have louder sound by connecting additional speakers.	<p><b>1)</b> Use the 3.5mm headphone output and a 3.5mm to phono cable (available separately) to connect to an amplifier/surround sound system. Please note this will deactivate the TV's built in speakers.</p> <p><b>2)</b> Connect a COAX cable from the TV's COAX output to your amplifier/surround systems COAX input.</p>
General	Why are some options in the menu unavailable and greyed out.	Some options are only available in certain sources, i.e. HDMI. They are unavailable in the other sources where they have no affect.
General	Can I stop my TV automatically turning off after 4hrs?	Yes, in the 'Time' menu settings, scroll down to Auto standby and select OFF.
TV	I have tuned in Digital TV but I am not receiving any or all of the channels and/or the channels I receive are breaking up.	<p><b>1)</b> Check you are in an area that can receive Freeview/Saorview, visit <a href="http://www.freeview.co.uk">www.freeview.co.uk</a> or <a href="http://www.saorview.ie">www.saorview.ie</a></p> <p><b>2)</b> Check you are using an aerial that is able to receive a good digital signal. In most cases, you will need an outdoor digital hi-gain/wideband aerial. In areas that have excellent digital coverage, you may be able to use a loft type aerial but it is highly likely that you will also need to connect a booster between the back of the TV and the TV aerial wall socket. Unfortunately, to receive a good enough digital signal, it is not possible to use a portable/indoor type aerial.</p>
TV	I have re-tuned my television but when I switch it off it is not storing the channels.	<p>If the TV does not save the channels when you power it off, it's likely the channel database has become corrupt.</p> <p><b>1)</b> Turn off the TV.</p> <p><b>2)</b> Remove the RF/Aerial cable from the rear of the TV and then turn the TV back on again.</p> <p><b>3)</b> Using the remote control, press Menu followed by 8-8-8-8 to enter the initial setup/first time installation menu.</p> <p><b>4)</b> Press OK (let the TV run the full tuning process).</p> <p><b>5)</b> Once completed, turn off the TV, reconnect the RF/Aerial cable then turn the TV back on again.</p> <p><b>6)</b> Repeat steps 3 &amp; 4.</p>
VCR/DVD Recorder	I have connected the TV to my VCR or DVD Recorder via SCART but it is not recording.	In addition to connecting via SCART, you should connect the aerial cable from the wall socket to your VCR/DVD Recorder and another aerial cable from the VCR/DVD Recorder to the TV.
Game Consoles	I have connected my Playstation/ Xbox to the TV via HDMI, but I am not receiving any pictures or sound on my Television.	<p><b>1)</b> Ensure the TVs' source is set to HDMI.</p> <p><b>2)</b> Check your settings on your Playstation/Xbox are as per the Playstation/Xbox instruction manual.</p>

**Note:**

Supplier may change TV software and on screen graphics without warning

# Frequently Asked Questions

Game Consoles	I have connected my Playstation/ Xbox to the TV via Component cables (red, green & blue) but I am not receiving any sound.	Component cables only provide HD pictures. For the sound you will need to connect the red & white audio cables on the Playstation/Xbox to the red & white phono inputs (or mini AV input where fitted) on the rear of the TV. Please refer to the 'Connections' pages.
System Lock	I have changed the password on the television and now forgotten it.	There is a master password of 4711, to gain access to the TV menu and reset the normal password.
USB Mode	I have inserted a USB Memory Key, but the TV does not recognise it.	Ensure the USB Memory Key is formatted to type FAT32.
USB Mode	Using a USB portable hard drive / larger than 32GB.	If you wish to use a portable hard drive larger than 32GB, please note that it must be formatted to the FAT32 file system in order to operate on this TV. Windows XP/Vista computers are only capable of formatting up to 32GB, therefore, you will need a software programme/utility to format larger hard drives. Please refer to the website, <a href="http://www.umc-uk.co.uk">www.umc-uk.co.uk</a> , for more information.
DVD	I have inserted a disc but it is not playing.	<ol style="list-style-type: none"> <li>1) Ensure you have inserted the disc facing the correct way.</li> <li>2) Ensure the disc is clean and is not scratched.</li> <li>3) Some copied discs will not play.</li> <li>4) Check the DVD is a region 2 disc – to change the region of the DVD player, refer to <a href="http://www.umc-uk.co.uk">www.umc-uk.co.uk</a>, select 'Changing DVD Region' in the 'Product Support' section</li> </ol>
DVD	I have pressed the eject button but the disc is not coming out.	To eject the disc hold the stop/eject button for 4 seconds.

# Technical Specification

## Product Fiche

Supplier	Bush
Model ID	32/133DVDB 32/133DVDW
Energy efficiency class	A +
Visible screen size (diagonal)	81 cm / 32 inches
On mode average power consumption	31 W
Annual energy consumption *1	45 kWh
Standby power consumption *2	<0.5 W
Off mode power consumption	0 W
Screen resolution	1366 (w) x 768 (H)
*1: Energy consumption XYZ kWh per year, based on the power consumption of the television operating 4 hours per day for 365 days. The actual energy consumption will depend on how the television is used.	
*2: When the TV is turned off with the remote control/standby button and no function is active.	

Additional Technical Information	
RF	75 ohm Antenna / Analog / DVB
Video Inputs	3 x HDMI, 1 x USB, 1 x SCART, 1 x Composite/Video, 1 x Mini Component/YPbPr, 1 x VGA/PC,
Sound Inputs	1 x shared audio for Composite/Video & Component/YPbPr, 1 x 3.5mm jack for PC audio input
Sound Outputs	1 x Coax Audio output, 1 x 3.5mm Headphone
Speaker / Amplifier Watts (RMS)	2 x 10W / 2 x 8W
Dimensions including stand (mm)	739 W x 485 H x 180 D
Net weight	5.8 kgs
Energy Consumption Info	
Voltage and power consumption	110-240v 50 / 60Hz 31 / 45 / 80W (home/standard/max) EEI - A+ (Energy Rating)
Wallmounting VESA	200 x 100 (mm)



# Technical Specification

## Compatible files in USB Mode

Media	File Ext.	Codec		Remark
		Video	Audio	
Movie	.mpg	MPEG-1, MPEG-2	MP3, WMA, AAC	Max Resolution: 1920x1080 Max Data rate: 40 Mbps
	.avi	Xvid, MJPEG, MPEG-4 SP/ASP, H.264		Max Resolution: 1920x1080 Max Data rate: 20 Mbps
	.ts	MPEG-2, H.264		
	.mov/ .mkv	MPEG-4 SP/ASP, H.264		
	.dat	MPEG-1		
	.mp4	MPEG-4 SP/ASP, H.264		
		MPEG-1, MPEG-2		
.vob	MPEG-2	Max Resolution: 720x576 Max Data rate: 40 Mbps		
Music	.mp3	-	MP3	Sample Rate 8K-48KHz Bit rate: 32K - 320Kbps Channel: Mono/Stereo
	.wma	-	WMA	
	.m4a/ .aac	-	AAC	Sample Rate 16K-48KHz Bit rate: 32K ~ 442Kbps Channel: Mono/Stereo
Photo	.jpg/ .jpeg	Progressive JPEG		Max Resolution: 1024x768
		Baseline JPEG		Max Resolution: 8192x8192
	.bmp	BMP		Max Resolution: 6500x6500 Pixel Depth 1/4/8/16/24/32 bpp
	.png	Non-Interlaced		Max Resolution: 3000x3000
		Interlaced		Max Resolution: 1500x1500





For any help concerning set up and use of your TV please call the Customer Helpline **on page 3**

