

ASSEMBLY

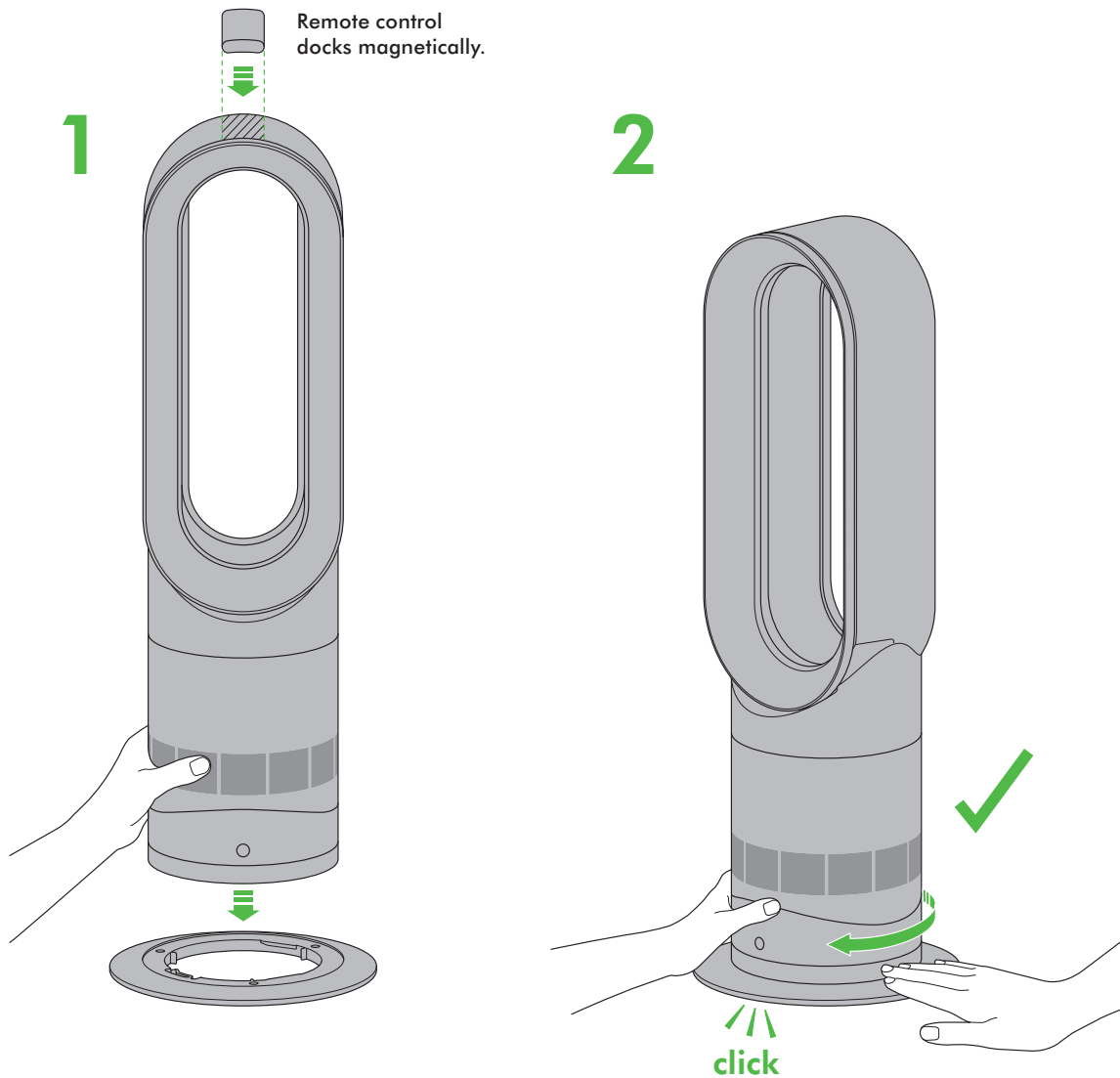

REGISTER
YOUR FREE 2 YEAR
GUARANTEE TODAY



DYSON CUSTOMER CARE

THANK YOU FOR CHOOSING TO BUY A DYSON APPLIANCE

After registering your free 2 year guarantee, your Dyson appliance will be covered for parts and labour for 2 years from the date of purchase, subject to the terms of the guarantee. If you have any questions about your Dyson appliance, call the Dyson Helpline with your serial number and details of where/when you bought the appliance. Most questions can be solved over the phone by one of our trained Dyson Helpline staff.

Your serial number can be found on your rating plate which is on the base of the appliance. Alternatively, visit www.dyson.co.uk/support (UK) or www.dyson.ie/support (ROI) for online help, general tips and useful information about Dyson.

Note your serial number for future reference.

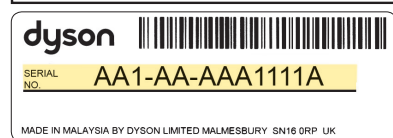

This illustration is for example purposes only.

DYSON CONTACT DETAILS

UK:

Website: www.dyson.co.uk/support

Dyson Helpline: 0800 298 0298

Email: askdyson@dyson.co.uk

Address: Dyson Ltd, Tetbury Hill,
Malmesbury, Wiltshire, SN16 0RP

ROI:

Website: www.dyson.ie/support

Dyson Helpline: 01 475 7109

Email: askdyson@dyson.co.uk

Address: Dyson Ireland Limited, Unit G10, Grants Lane,
Greenogue Business Park, Rathcoole, Dublin 24

3 EASY WAYS TO REGISTER YOUR FREE 2 YEAR GUARANTEE

REGISTER ONLINE

Visit our website to register your full parts and labour guarantee online.

www.dyson.co.uk/register
www.dyson.ie/register



REGISTER BY PHONE

Call our dedicated Helpline. Open Monday to Friday 8am-8pm & Saturday and Sunday 8am-6pm.

UK: 0800 298 0298
ROI: 01 475 7109



REGISTER BY MAIL

Complete and return the form to Dyson in the envelope supplied.



IMPORTANT SAFETY INSTRUCTIONS

BEFORE USING THIS APPLIANCE READ ALL INSTRUCTIONS AND CAUTIONARY MARKINGS IN THIS MANUAL AND ON THE APPLIANCE

When using an electrical appliance, basic precautions should always be followed, including the following:

WARNING

THE FAN AND THE REMOTE CONTROL BOTH CONTAIN MAGNETS.

1. Pacemakers and defibrillators may be affected by strong magnetic fields. If you or someone in your household has a pacemaker or defibrillator, avoid placing the remote control in a pocket or near to the appliance.
2. Credit cards and electronic storage media may also be affected by magnets and should be kept away from the remote control and the top of the appliance.

WARNING

These warnings apply to the appliance, and also where applicable, to all tools, accessories, chargers or mains adaptors.

TO REDUCE THE RISK OF FIRE, ELECTRIC SHOCK, OR INJURY:

3. When used in heating mode the appliance is hot when in use and for a short period after use. To avoid burns, do not let bare skin touch hot surfaces. When moving the appliance hold it by the base, not the air loop amplifier.
4. Keep combustible materials, such as furniture, pillows, bedding, papers, clothes and curtains, at least 0.9m (3 feet) from the front of the appliance and keep them away from the sides and rear when the appliance is plugged in.
5. This Dyson appliance can be used by children aged from 8 years and above and persons with reduced physical, sensory or reasoning capabilities, or lack of experience and knowledge, only if they have been given supervision or instruction by a responsible person concerning use of the appliance in a safe way and understand the hazards involved. Cleaning and user maintenance shall not be made by children without supervision.
6. Use only as described in this Dyson Operating Manual. Do not carry out any maintenance other than that shown in this manual, or advised by the Dyson Helpline. Any other use not recommended by the manufacturer may cause fire, electric shock, or injury to persons.
7. The base must be fitted securely before operating. Do not dismantle or use without the base fitted.
8. Do not allow to be used as a toy. Close attention is necessary when used by or near children. Children of less than 3 years should be kept away unless continuously supervised. Children should be supervised to ensure that they do not play with the appliance and remote control.
9. Children aged from 3 years and less than 8 years shall only switch on/off the appliance provided that it has been placed or installed in its intended normal operating position and they have been given supervision or instruction concerning use of the appliance in a safe way and understand the hazards involved. Children aged from 3 years and less than 8 years shall not plug in, regulate and clean the appliance or perform user maintenance. **CAUTION** – Some parts of this product can become very hot and cause burns. Particular attention has to be given where children and vulnerable people are present.
10. Suitable for dry locations **ONLY**. Do not use outdoors or on wet surfaces. Do not use in bathrooms, laundry areas or similar indoor locations. Never locate the appliance where it may fall into a bath or other water container. Do not use or store where it may get wet or in the immediate surroundings of a bath, a shower, or a swimming pool.
11. This appliance has hot parts inside. Do not use it in areas where petrol, paint, or flammable liquids are used or stored or where their vapours are present. Do not use in conjunction with or directly next to an air freshener or similar products.
12. Do not locate directly below a mains electricity supply socket.
13. Always plug directly into a wall socket. Never use with an extension cable as overloading may result in the cable overheating and catching fire.

14. Do not handle any part of the plug or appliance with wet hands.
15. Do not use with a damaged cable or plug. If the supply cable is damaged it must be replaced by Dyson, its service agent or similarly qualified person in order to avoid a hazard.
16. Do not unplug by pulling on the cable. To unplug, grasp the plug, not the cable.
17. Do not stretch the cable or place the cable under strain. Keep cable away from heated surfaces.
18. Do not route the cable under furniture or appliances. Do not cover cable with throw rugs, runners or similar coverings. Arrange cable away from traffic area and where it will not be tripped over.
19. To prevent a possible fire, do not use with any opening or exhaust blocked, and keep free of dust, lint, hair, and anything that may reduce airflow. Do not put any object into the inlet grill or the exhaust opening as this may cause an electric shock or fire, or damage the appliance.
20. Do not use on soft surfaces, such as a bed, where openings may become blocked.
21. In order to avoid overheating and fire hazard, do not cover the appliance.
22. For the best performance, place on the floor, in the corner of the room, at least 1m from any wall and facing into the centre of the room.
23. Turn off all controls before unplugging.
24. Do not use any cleaning agents or lubricants on this appliance. Unplug before cleaning or carrying out any maintenance.
25. If there is a loose fit between the plug and the socket or the plug becomes very hot, the socket may need to be replaced. Check with a qualified electrician to replace the socket.
26. Choking hazard - This remote control unit contains a small battery. Keep the remote control away from children and do not swallow the battery. If the battery is swallowed seek medical advice at once.
27. If the appliance is not working as it should, has received a sharp blow, has been dropped, damaged, left outdoors, or dropped into water, do not use and contact the Dyson Helpline.
28. Contact the Dyson Helpline when service or repair is required. Do not disassemble the appliance as incorrect reassembly may result in an electric shock or fire.



IMPORTANT SAFETY FEATURES

For your safety this appliance is fitted with automatic cut-out switches that operate if it tips over or overheats. If the switches operate, unplug the appliance and allow it to cool. Before restarting, check and clear any blockages and ensure the appliance is on a solid level surface.

READ AND SAVE THESE INSTRUCTIONS

THIS DYSON APPLIANCE IS INTENDED FOR HOUSEHOLD USE ONLY

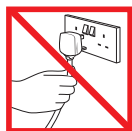

Do not pull on the cable.



In order to avoid overheating and fire hazard, do not cover the appliance.

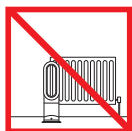

Do not store near heat sources.



Do not carry by the air loop amplifier. The air loop amplifier is not a handle.



Do not use near naked flames.

Power



Each time the heating mode is selected, it conducts a short calibration cycle. Airflow will be automatically controlled during this cycle. Once the calibration cycle is complete, it will revert to the selected airflow speed.

On first use, the appliance will default to a temperature 3°C higher than the detected room temperature. Thereafter, the appliance will remember the last target temperature set.

Select the desired room temperature. Pressing the large red button increases the target temperature by 1°C; the smaller red button decreases it by 1°C. The appliance will not operate in heater mode unless the target temperature is above the room temperature.

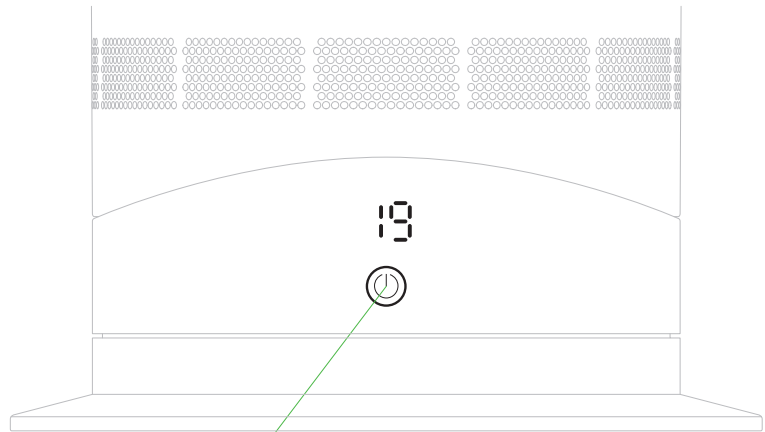

Press and hold the power button to run through the target temperatures.

Remote control

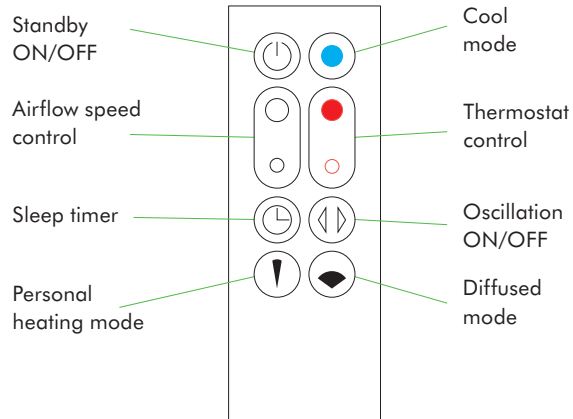

Remote control docks magnetically.
Attach the remote control to the top of the appliance with the buttons facing down.

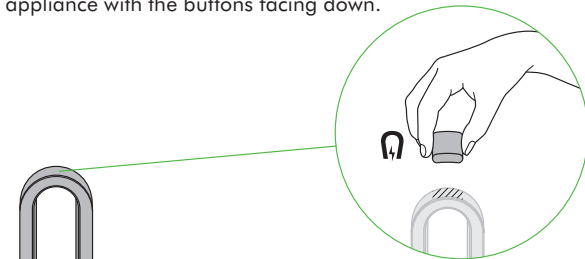

To operate, point the remote control toward the front of the base.

Heating and cool modes

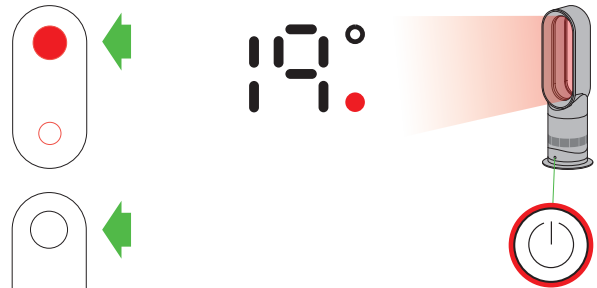

Heating mode

Press the red thermostat control button until the digital display shows the desired target temperature. The power button light will change from blue to red. The red circle will disappear when the target temperature has been reached.



Cool mode

Press the blue thermostat control button to change the target temperature to 0°C. The power button light will change from red to blue. To adjust the airflow speed use the airflow control button.

Sleep timer

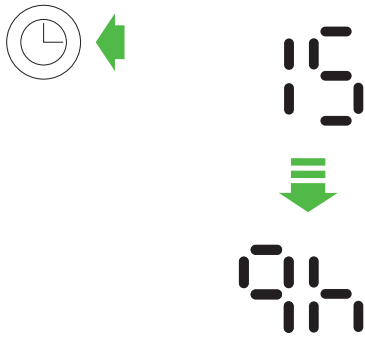

To set the sleep timer, press and hold the timer button to select the desired time. When time reaches zero, the appliance will go into standby mode. To cancel, reduce the time until two dashes appear.

Tilt function

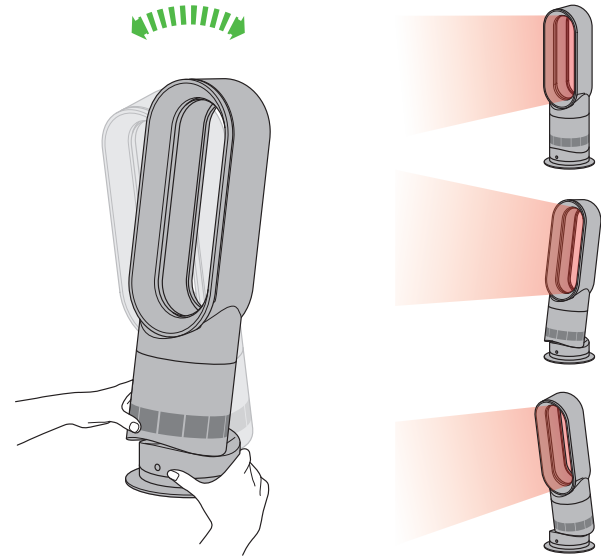

Carefully hold the base and the main body. Tilt the amplifier forward or backward for the required airflow angle.

Diffused and personal heating modes

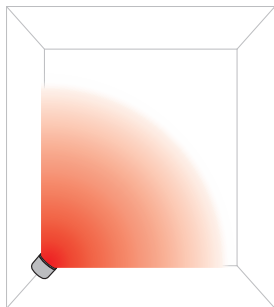

Diffused mode
Press the wide angle button to change from personal heating to whole room heating.
Heating and cool modes work in this mode.

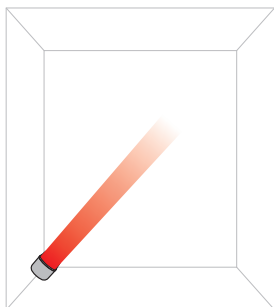

Personal heating mode
Press the narrow angle button to change from whole room heating to personal heating.
Heating and cool modes work in this mode.

Oscillation and airflow speed control

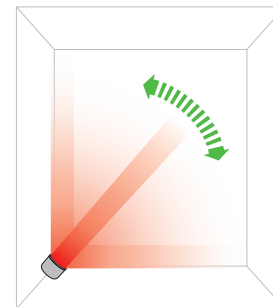

Oscillation control
To start the appliance oscillating, press the oscillation control button. To stop the appliance oscillating, press it again. The appliance will not oscillate when the control buttons are pressed.

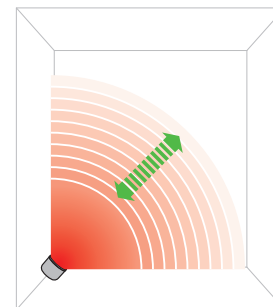
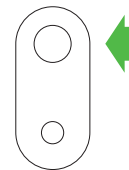

Airflow speed control
To change the airflow speed press the airflow control button. The digital display will show the new speed; after 3 seconds it will change back to the target temperature.

Clearing blockages

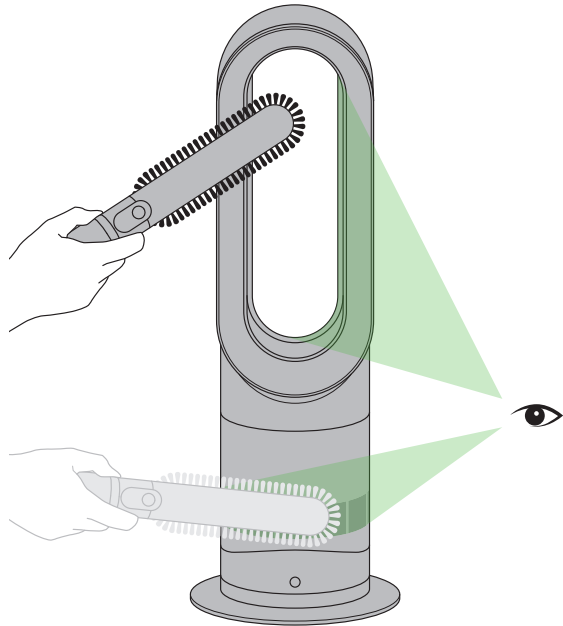

Ensure the appliance is unplugged and has been allowed to cool. Look for blockages in the air inlet holes and in the small aperture inside the air loop amplifier. Use a soft brush to remove debris.

Cleaning

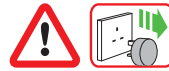

Unplug from the mains electricity supply. Allow to cool for 1 to 2 hours before cleaning if the appliance has been in use. To clean, wipe with a dry or damp cloth. Do not use detergents or polishes.

CAUTION: hot when in use

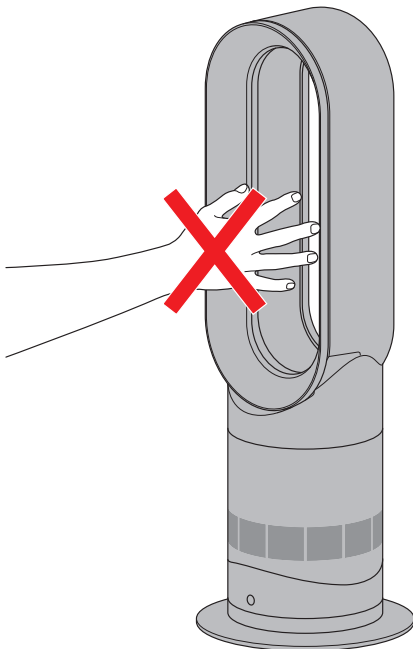

This appliance is hot when in use and for a short period after use. Do not let bare skin touch hot surfaces. If children are present, consider positioning the appliance out of their reach.

Battery replacement

Battery type CR 2032.

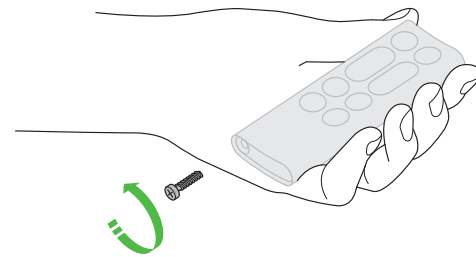

Unscrew the battery compartment on the remote control. Loosen the base and pull to remove the battery.

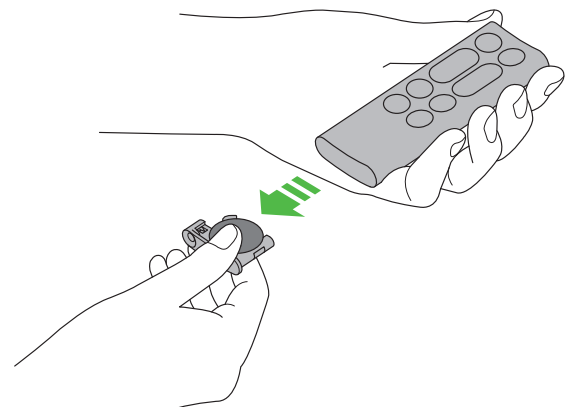

USING YOUR DYSON APPLIANCE

PLEASE READ THE 'IMPORTANT SAFETY INSTRUCTIONS' IN THIS DYSON OPERATING MANUAL BEFORE PROCEEDING.

LOOKING AFTER YOUR DYSON APPLIANCE

- Do not carry out any maintenance or repair work other than that shown in this Dyson Operating Manual, or advised by the Dyson Helpline.
- Always disconnect the plug from the mains before inspecting for problems. If the appliance will not operate, first check the mains socket has electricity supply and that the plug is properly inserted into the socket.

OPERATION

- Ensure appliance is fully assembled in line with the instructions before use. Do not dismantle the appliance or use without the loop amplifier fitted.
- The appliance will not operate in heating mode unless the target temperature is above the room temperature.
- Each time the heating mode is selected, it conducts a short calibration cycle. Airflow will be automatically controlled during this cycle. Once the calibration cycle is complete, it will revert to the selected airflow speed.
- The appliance will not oscillate when the control buttons are pressed.
- Do not lubricate any part of this appliance.

CONTROL WITHOUT THE REMOTE

- Press the power button on the appliance to turn ON/OFF.
- Press and hold the standby button on the appliance to adjust the target temperature. The target temperature will increase to a maximum before decreasing. If the target temperature is set at 0°C it will switch from heating to cool mode.
- The airflow, diffused and personal heating modes, oscillation function and sleep timer controls cannot be operated without the remote control.

TILT FUNCTION

- Carefully hold the base and the main body. Tilt the amplifier forward or backward for the required airflow angle.

AUTOMATIC CUT-OUT

- For your safety this appliance is fitted with automatic cut-out switches that operate if the appliance tips over or overheats. If the switches operate, unplug the appliance and allow it to cool. Before restarting the appliance check and clear any blockages and ensure the appliance is on a solid level surface.
- In heating mode the appliance will automatically switch 'OFF' after 9 hours of continuous use and will return to standby mode. To restart the machine, press the power button on either the remote control or the base.

TROUBLESHOOTING

- Fault codes F4, F5, F6: If one of these appears on the display, unplug the appliance, wait for 30 to 60 seconds and/or plug the appliance into a different socket. If you continue to receive the fault code, please contact the Dyson Helpline.
- Fault codes F2, F3, F7: If one of these appears on the display, please contact the Dyson Helpline.

BATTERY REPLACEMENT

CAUTION

- Unscrew the battery compartment on the remote control. Loosen the base and pull to remove the battery.
- Do not install backwards or short circuit the batteries.
- Do not attempt to dismantle or charge the batteries. Keep away from fire.
- Follow battery manufacturers' instructions when installing new batteries (battery type CR 2032).
- Limited functionality is available without the remote control (see 'Control without the remote').

DISPOSAL INFORMATION

- Dyson products are made from high grade recyclable materials. Recycle where possible.
- The battery should be removed from the product before disposal.
- Dispose of or recycle the battery in accordance with local ordinances or regulations.

 This marking indicates that this product should not be disposed with other household wastes throughout the EU. To prevent possible harm to the environment or human health from uncontrolled waste disposal, recycle it responsibly to promote the sustainable reuse of material resources. To return your used device, please use the return and collection systems or contact the retailer where the product was purchased. They can take this product for environmental safe recycling.

DYSON CUSTOMER CARE

THANK YOU FOR CHOOSING TO BUY A DYSON APPLIANCE

After registering your free 2 year guarantee, your Dyson appliance will be covered for parts and labour for 2 years from the date of purchase, subject to the terms of the guarantee. If you have any questions about your Dyson appliance, call the Dyson Helpline with your serial number and details of where/when you bought the appliance.

Most questions can be solved over the phone by one of our trained Dyson Helpline staff.

Alternatively, visit www.dyson.co.uk/support (UK) or www.dyson.ie/support (ROI) for online help, general tips and useful information about Dyson.

Your serial number can be found on your rating plate which is on the base of the appliance.

If your Dyson appliance needs a service, call the Dyson Helpline so we can discuss the available options. If your Dyson appliance is under guarantee, and the repair is covered, it will be repaired at no cost.

PLEASE REGISTER AS A DYSON APPLIANCE OWNER

To help us ensure you receive prompt and efficient service, please register as a Dyson appliance owner. There are three ways to do this:

- Online at www.dyson.co.uk/register (UK) or www.dyson.ie/register (ROI).
- Telephone the Dyson Helpline on 0800 298 0298 (UK) or 01 475 7109 (ROI).

- Complete the enclosed form and post it to us. This will confirm ownership of your Dyson appliance in the event of an insurance loss, and enable us to contact you if necessary.

LIMITED 2 YEAR GUARANTEE

TERMS AND CONDITIONS OF THE DYSON 2 YEAR LIMITED GUARANTEE

WHAT IS COVERED

- The repair or replacement of your Dyson appliance (at Dyson's discretion) if it is found to be defective due to faulty materials, workmanship or function within 2 years of purchase or delivery (if any part is no longer available or out of manufacture Dyson will replace it with a functional replacement part).
- Where this machine is sold outside of the EU, this warranty will only be valid if the appliance is used in the country in which it was sold.
- Where this machine is sold within the EU, this warranty will only be valid (i) if the appliance is used in the country in which it was sold or (ii) if the appliance is used in Austria, Belgium, France, Germany, Ireland, Italy, Netherlands, Spain or the United Kingdom and the same model as this appliance is sold at the same voltage rating in the relevant country.

WHAT IS NOT COVERED

Dyson does not guarantee the repair or replacement of a product where a defect is the result of:

- Accidental damage, faults caused by negligent use or care, misuse, neglect, careless operation or handling of the appliance which is not in accordance with the Dyson Operating Manual.
- Use of the appliance for anything other than normal domestic household purposes.
- Use of parts not assembled or installed in accordance with the instructions of Dyson.
- Use of parts and accessories which are not genuine Dyson components.
- Faulty installation (except where installed by Dyson).
- Repairs or alterations carried out by parties other than Dyson or its authorised agents.
- Blockages – please refer to the Dyson Operating Manual for details of how to look for and clear blockages.
- Normal wear and tear (e.g. fuse etc.).
- Reduction in battery discharge time due to battery age or use (where applicable).

If you are in any doubt as to what is covered by your guarantee, please contact the Dyson Helpline.

SUMMARY OF COVER

- The guarantee becomes effective at the date of purchase (or the date of delivery if this is later).
- You must provide proof of (both the original and any subsequent) delivery/purchase before any work can be carried out on your Dyson appliance. Without this proof, any work carried out will be chargeable. Keep your receipt or delivery note.
- All work will be carried out by Dyson or its authorised agents.
- Any parts which are replaced by Dyson will become the property of Dyson.
- The repair or replacement of your Dyson appliance under guarantee will not extend the period of guarantee.
- The guarantee provides benefits which are additional to and do not affect your statutory rights as a consumer.

ABOUT YOUR PRIVACY

- Your information will be held by Dyson and its agents for promotional, marketing and servicing purposes.
- If your personal details change, if you change your mind about any of your marketing preferences or if you have any queries about how we use your information, please contact the Dyson Helpline.
- For more information on how we protect your privacy, please see our privacy policy on the Dyson website.



DYSON CUSTOMER CARE

If you have a question about your Dyson appliance, call the Dyson Customer Care Helpline with your serial number and details of where and when you bought the appliance, or contact us via the Dyson website.

DYSON CONTACT DETAILS

UK:

Website: www.dyson.co.uk/support

Dyson Helpline: 0800 298 0298

Email: askdyson@dyson.co.uk

Address: Dyson Ltd, Tetbury Hill, Malmesbury, Wiltshire, SN16 0RP

ROI:

Website: www.dyson.ie/support

Dyson Helpline: 01 475 7109

Email: askdyson@dyson.co.uk

Address: Dyson Ireland Limited, Unit G10, Grants Lane, Greenogue Business Park, Rathcoole, Dublin 24



GUARANTEE FORM

Serial number

Date of purchase

 / /

Country of purchase

 UK ROI

Title

Surname

First name

Address

Postcode

e-mail

Telephone

Mobile

As a Dyson fan owner, you can hear about Dyson inventions, services and products before anyone else. If it's okay to contact you, please let us know how we may do this.

We sometimes ask other companies (such as market researchers) to contact owners on our behalf. We do this to get feedback on ideas or ask you to try new products and services. Would this be okay?

- By mail Yes No
- By phone Yes No
- By email Yes No
- By text message Yes No

- Yes No

3 EASY WAYS TO REGISTER YOUR FREE 2 YEAR GUARANTEE

REGISTER ONLINE



Visit our website to register your full parts and labour guarantee online.

www.dyson.co.uk/register
www.dyson.ie/register

REGISTER BY PHONE



Call our dedicated Helpline. Open Monday to Friday 8am-8pm & Saturday and Sunday 8am-6pm.

UK: 0800 298 0298
ROI: 01 475 7109

REGISTER BY MAIL



Complete and return the form to Dyson in the envelope supplied.

