

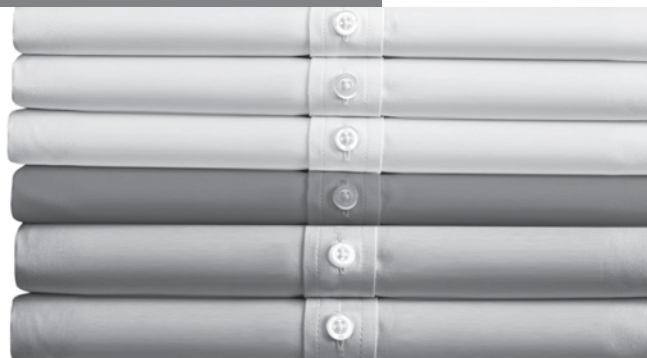

Register your new Bosch now:
<http://www.bosch-home.co.uk>



Sensixx'x DA50



BOSCH

en Operating instructions

Index	pag
General safety instructions	4
Description	7
Before using your appliance for the first time	7
Using your appliance	7
1. Filling the water tank	7
2. Setting the temperature	8
3. Ironing with steam	8
4. Shot of steam	9
5. Vertical steam	9
6. Ironing without steam	10
7. Drip protection *	11
8. Spray	11
9. "secure" auto shut-off function *	11
10. After ironing	12
Tips to help you save energy	12
Cleaning & Maintenance	13
Multiple descaling system	14
"TextileProtect" fabric protector *	16
"StoreProtect" *	16
Trouble shooting	17
Guarantee conditions	18

Thank you for buying the Sensixx'x DA50 steam iron from Bosch.

Carefully read through the operating instructions for the appliance and safeguard them for future reference.

You can download this manual from the local homepages of Bosch.

General safety instructions

- The iron must not be left unattended while it is connected to the supply mains.
- Remove the plug from the socket before filling the appliance with water or before pouring out the remaining water after use.
- The appliance must be used and placed on a stable surface.
- When placed on its stand, make sure that the surface on which the stand is placed is stable.
- The iron should not be used if it has been dropped, if there are visible signs of damage or if it is leaking water. It must be checked by an authorized Technical Service Centre before it can be used again.
- With the aim of avoiding dangerous situations, any work or repair that the appliance may need, e.g. replacing a faulty mains cable, must only be carried out by qualified personnel from an Authorised Technical Service Centre.
- This appliance can be used by children aged from 8 years and above and persons with reduced physical, sensory or mental capabilities or lack of experience and knowledge if they have been given supervision or instruction concerning use of the appliance in a safe way and understand the hazards involved. Children shall not play with the appliance. Cleaning and user maintenance shall not be made by children without supervision.
- Keep the iron and its cord out of reach of children less than 8 years of age when it is energized or cooling down.
-  CAUTION. Hot surface.
Surface is liable to get hot during use.

Important notices

- This appliance has been designed exclusively for domestic use and must not be used for industrial purposes.
- This appliance must be used only for the purposes for which it was designed, i.e. as an iron. Any other use will be considered improper and consequently dangerous.
- The manufacturer will not be held responsible for any damage arising from misuse or improper use.
- This appliance reaches high temperatures and produces steam during use, this could cause scalds or burns in case of improper use.
 - Do not touch the soleplate! Hold the iron by its handle.
 - Do not leave the supply cord hanging over the table or ironing board, to prevent the appliance from falling.
 - Do not iron clothing while it is being worn!
 - Never spray or aim the steam at persons or animals!
- Do not allow the power cable to come into contact with sharp edges or with the soleplate when it is hot.
- Never rest the iron in a horizontal position when the soleplate is hot. Rest it on its heel.
- Do not touch the appliance with wet hands when in operation.
- This appliance is to be connected and used in accordance with the information stated on its characteristics plate.
- This appliance must be connected to an earthed socket. If it is absolutely necessary to use an extension cable, make sure that it is suitable for 16A and has a socket with an earth connection.
- The appliance must never be placed directly under the tap to fill the water tank.

- Unplug the appliance from the mains supply after each use, or if a fault is suspected.
- The electrical plug must not be removed from the socket by pulling the cable.
- Never immerse the iron in water or any other fluid.
- Do not leave the appliance exposed to weather conditions (rain, sun, frost, etc.).

Advice on disposal

Our goods come in optimized packaging. This basically consists in using non-contaminating materials which should be handed over to the local waste disposal service as secondary raw materials. Your local town council can give you information about how to dispose of obsolete appliances.



This appliance is labelled in accordance with European Directive 2012/19/EU concerning used electrical and electronic appliances (waste electrical and electronic equipment – WEEE).

The guideline determines the framework for the return and recycling of used appliances as applicable throughout the EU.

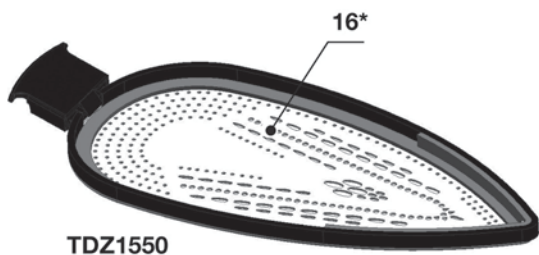
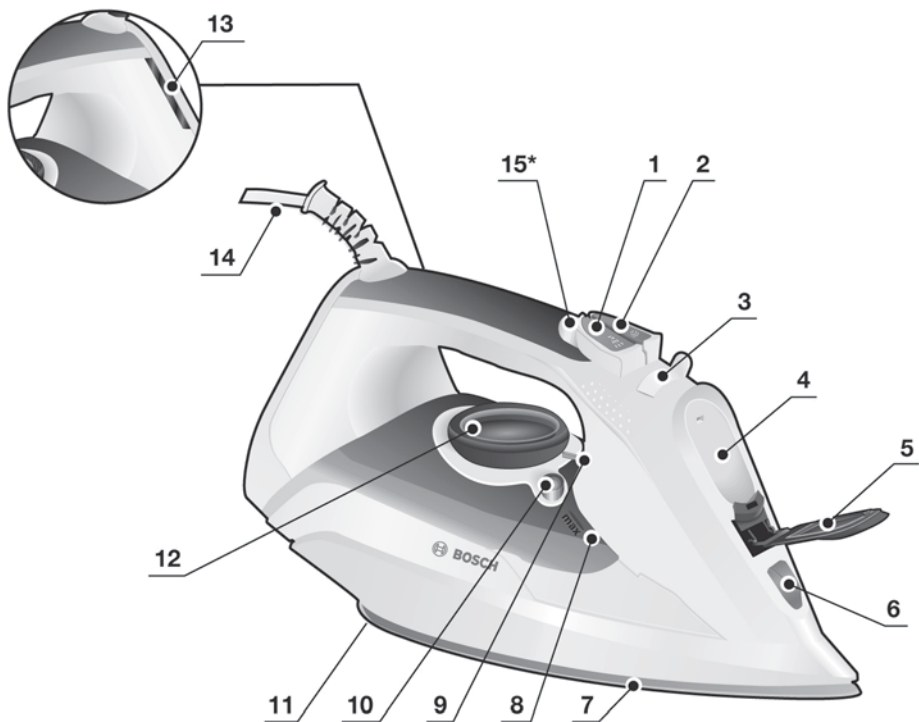

TDZ1550

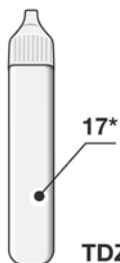

TDZ1101

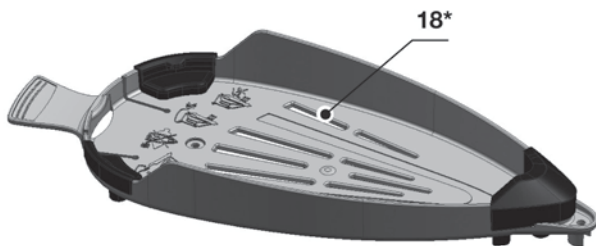

TDZ1750

* Model dependent

Description

1. Spray button
2. Shot of steam button
3. Steam regulator
4. Water inlet
5. Water inlet lid
6. Spray nozzle
7. Soleplate
8. Level mark for maximum filling
9. Temperature index
10. "clean" button
11. Water tank
12. Temperature control
13. Pilot light
14. Power cord
15. "auto off" indicator light *
16. "TextileProtect" fabric protector *
17. Descaling liquid *
18. "StoreProtect" accessory *

Before using your appliance for the first time

Remove any label or protective cover from the soleplate (7).

During its first use the iron may produce certain vapours and odours that will die away after a few minutes.

Using your appliance



1. Filling the water tank

This appliance has been designed to use normal tap water.

- The addition of other liquids, (unless recommended by Bosch) such as perfume, will damage the appliance.
- Do not use condensation water from tumble dryers, air conditioning systems or similar.

Any damage caused by the use of the aforementioned products will make the guarantee void.

⚠ Set the steam regulator (3) to the position and unplug the iron from the mains!

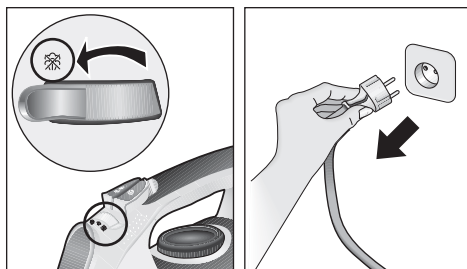

1. Open the water inlet lid (5).
2. Fill the water tank (11). **Never fill beyond the level mark for maximum filling (8).**

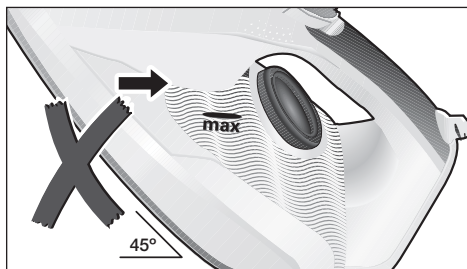
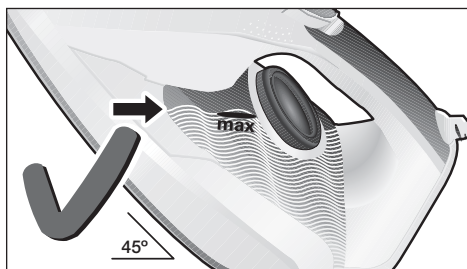
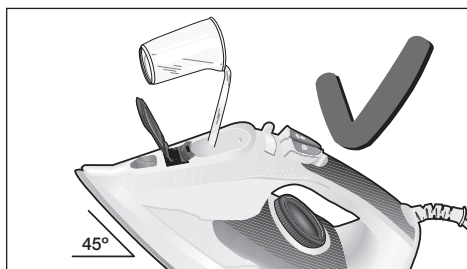

3. Close the water inlet lid.

* Model dependent

Tip: To prolong the optimum steam function, you may mix tap water with distilled water 1:1. If the tap water in your district is very hard, mix tap water with distilled water 1:2. You can inquire about the water hardness with your local water supplier.

2. Setting the temperature

The temperature control (12) adjusts the temperature of the soleplate (7).

Set the temperature control to the corresponding position by lining it up with the temperature index (9) on the iron.

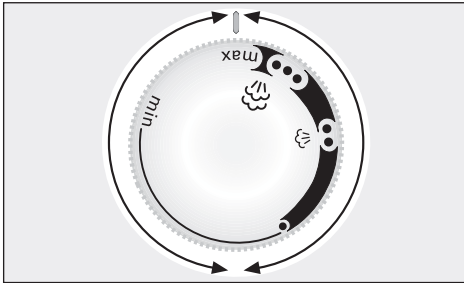

Temperature	Suitable for:
•	Synthetics
••	Silk – Wool
•••	Cotton
max	Linen

The pilot light (13) switches on while the appliance is heating up and switches off as soon as the set temperature is reached. If the temperature of the hot iron drops, you can continue ironing while the iron heats up again to the set temperature.

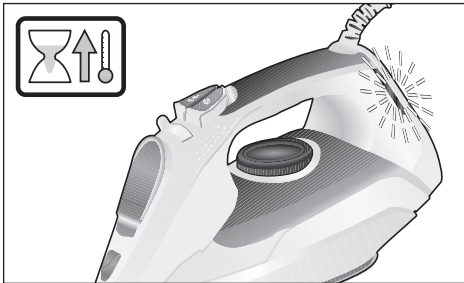

3. Ironing with steam

The steam regulator (3) is used to adjust the amount of steam produced when ironing.

Temperature control (12)	Recommended position of the steam regulator (3) *
	☀ 1 2 3 max
	☀ •eco• max
	☀ 1 2 3 max
	☀ •eco• max

Tip: For better ironing results, iron the last strokes without steam to dry the garment.

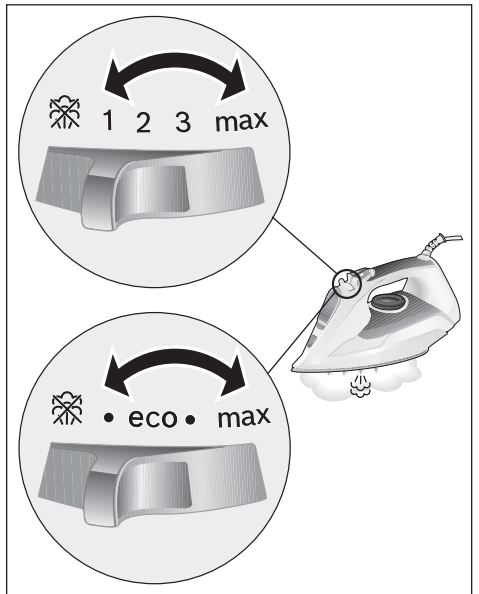
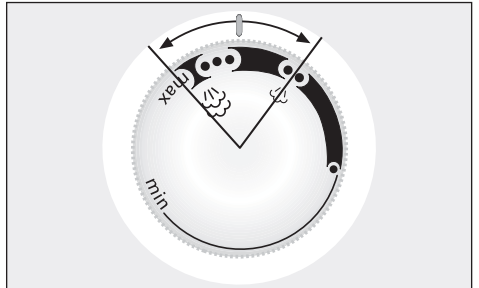





4. Shot of steam

This can be used to remove stubborn wrinkles or to press in a sharp crease or pleat.

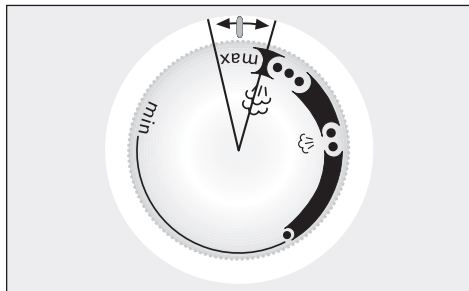
1. Set the temperature control (12) to "max".



2. Press the shot of steam button  (2) repeatedly with intervals of at least 5 seconds.

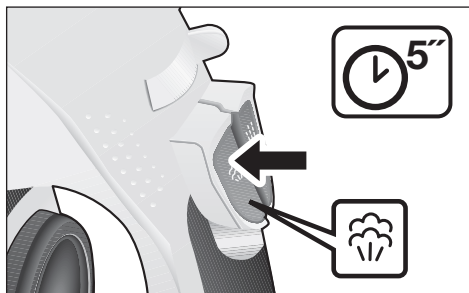

5. Vertical steam

This can be used to remove creases from hanging clothes, curtains etc.

Never direct the steam jet at garments that are being worn.

Never aim the steam at people or animals.

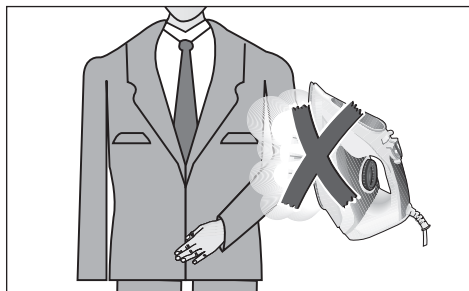

1. Set the temperature control (12) to "max".

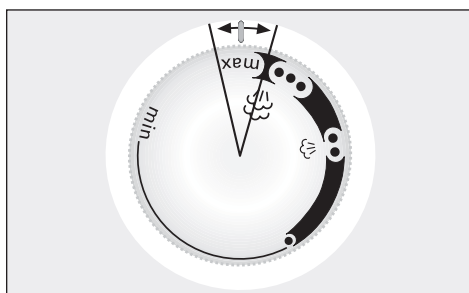

2. Hang article of clothing on a clothes hanger. Operate the iron in a vertical position at a distance of 10 cm / 4 in, and press the shot of steam button  (2) repeatedly with pauses of at least 5 seconds.

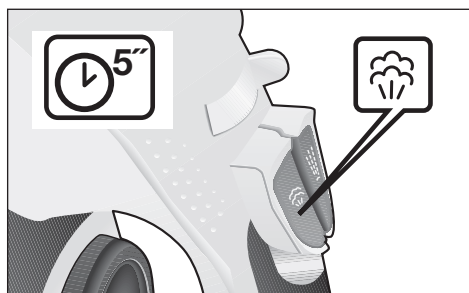
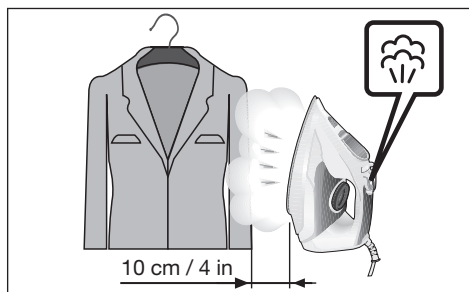

6. Ironing without steam

This enables the iron to be used for dry ironing.

1. Set steam regulator (3) to the  position.

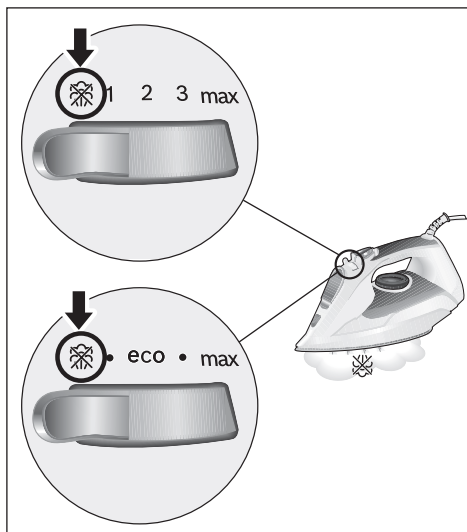

2. Select an appropriate temperature for the type of material being ironed (see "Setting the temperature" section).





7. Drip protection *

If the temperature is set too low, the steam is automatically switched off to avoid dripping.
There may be an audible click when this occurs.

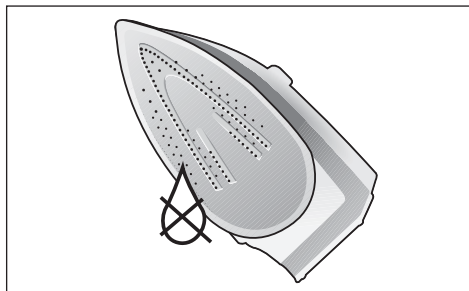

8. Spray

This can be used to remove stubborn wrinkles.

Do not use the spray function with silk.

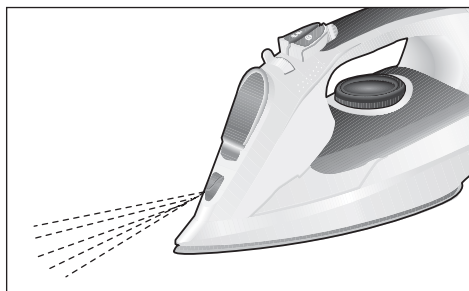
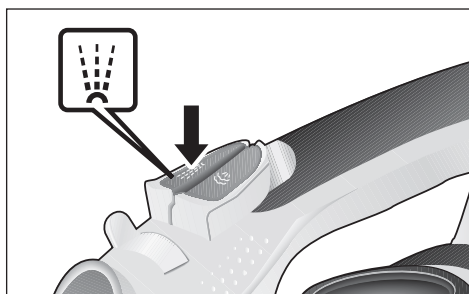

9. "secure" auto shut-off function *

The "secure" auto shut-off function switches off the iron when it is left unattended, thus increasing security and saving energy.

If your iron is equipped with "secure" function, you can find the text "auto off" on handle.

1. Plug in the iron.
2. Initial heating up process: this function will be inactive for the first two minutes in order to give the appliance time to reach the set temperature.

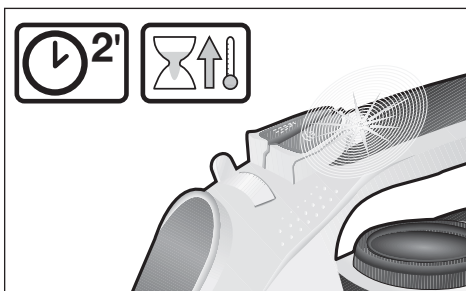

3. The safety circuit will switch the appliance off automatically and the indicator light (15*) will start flashing in the following cases:

- a If the iron is not moved for 30 seconds while resting on its soleplate or on its side.

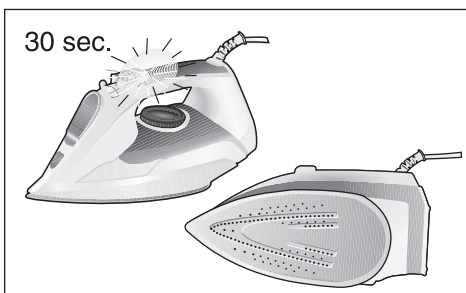

* Model dependent

- b If the iron is not moved for 8 minutes while in the upright position.

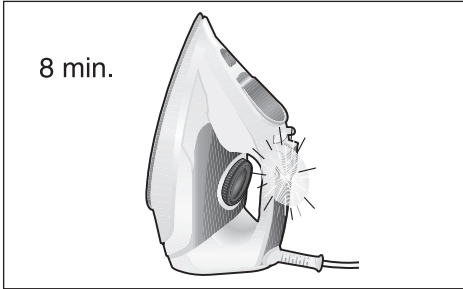

4. To reconnect the iron, just move it about gently.



10. After ironing

1. Switch the steam regulator (3) from ☀ to “max” and back again several times (self-cleaning).

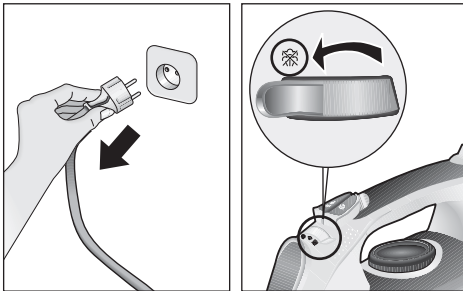

2. Empty the tank. Hold the iron with the point down and shake lightly.



3. Allow the soleplate (7) to cool down.

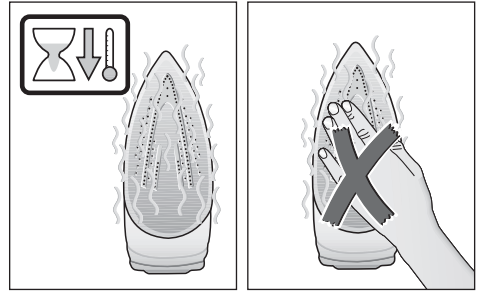

4. Store the iron standing on the rear, not on the soleplate. Do not wrap the power cord (14) too tight!

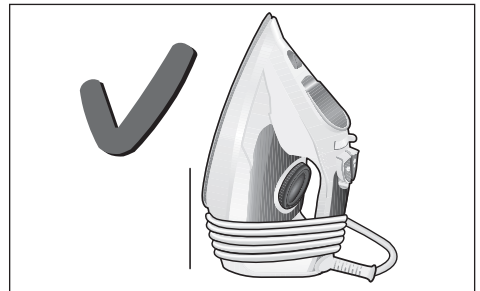
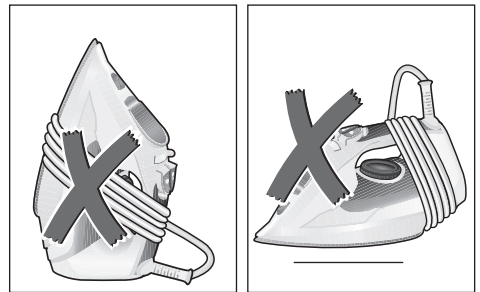



Tips to help you save energy

Steam production consumes the most energy. To help minimise the energy used, follow the advice below:

1. Start by ironing the fabrics that require the lowest ironing temperature. Check the recommended ironing temperature in the label on the garment.
2. Regulate the steam according to the selected ironing temperature, following the instructions in this manual.
3. Only use steam if necessary. If possible, use the spray function instead.
Try to iron the fabrics while they are still damp and reduce the steam setting. Steam will be generated from the fabrics rather than the iron.
If you tumble dry your fabrics before ironing them, set the tumble drier on the 'iron dry' program.
4. If the fabrics are damp enough, turn off the steam regulator (3) completely.
5. Stand the iron upright during pauses. Resting it horizontally with the steam regulator on generates wasted steam.

switch off the steam and rub off any residue immediately with a thickly folded, damp cotton cloth.

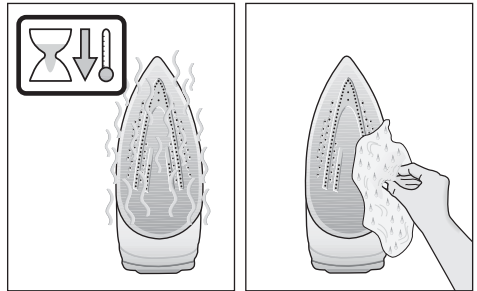

3. To keep the soleplate smooth, you should avoid hard contact with metal objects. Never use a scouring pad, or chemicals to clean the soleplate.

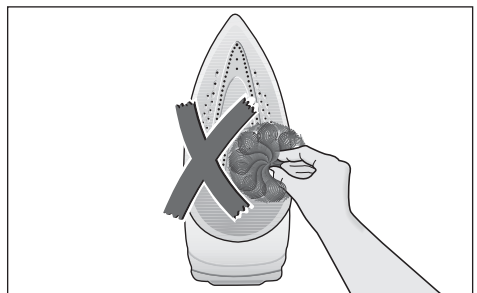

Cleaning & Maintenance



Attention! Risk of burns!

Always unplug the appliance from the mains supply before carrying out any cleaning or maintenance operation on it.

1. If the iron is only slightly soiled, pull out the plug and allow the soleplate (7) to cool down. Wipe the housing and the soleplate with a damp cotton cloth only.
2. If the cloth is synthetic, it may melt due to the high temperature on the soleplate,

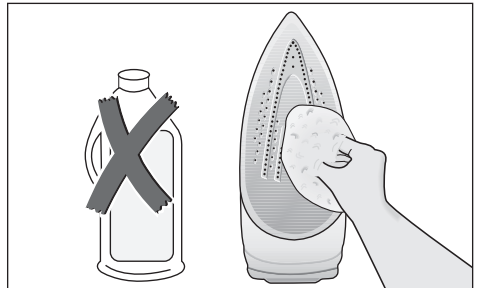



Multiple descaling system

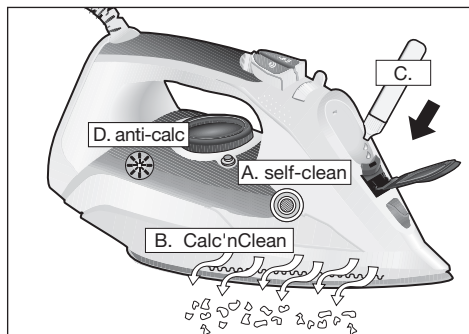

A self-clean

Each time you use the steam regulator (3), the “self-clean” system cleans the mechanism of scale deposits.

B Calc'nClean

The “Calc'nClean” function helps to remove scale particles out of the steam chamber. Use this function approximately every 2 weeks if the water in your area is very hard.

- 1 Unplug the iron from the mains socket, set the steam regulator (3) to the  position and fill the water tank (11) with water.

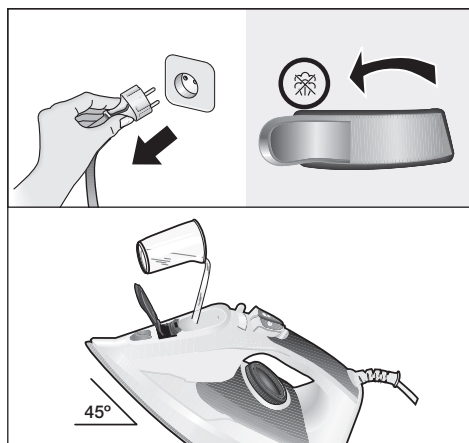

- 2 Set the temperature control (12) to the “max” position and plug in the iron.

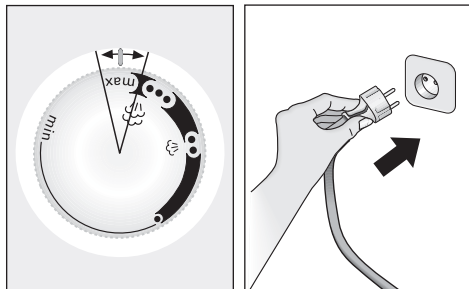

- 3 After the necessary warm-up period, the pilot light (13) goes out. Then, unplug the iron (**very important!**).

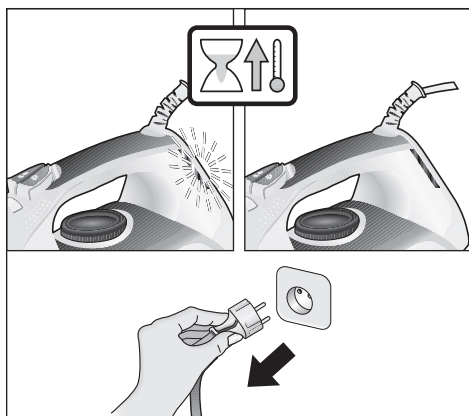

- 4 Set steam regulator to the “max” position.

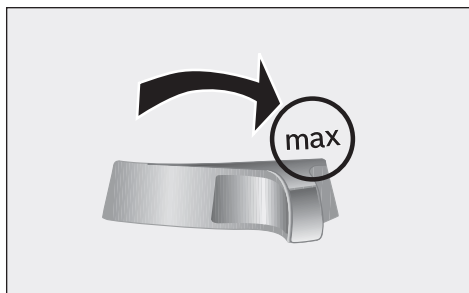

- 5 Hold the iron over a sink. Press the “clean” button (10) and shake the iron until approximately one third of the water capacity of the tank is evaporated. Boiling water and steam will come out, carrying scale or deposits that might be there.

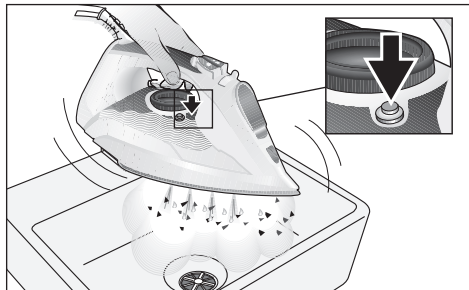

- 6 Release the “clean” button, and gently shake the iron for some seconds.

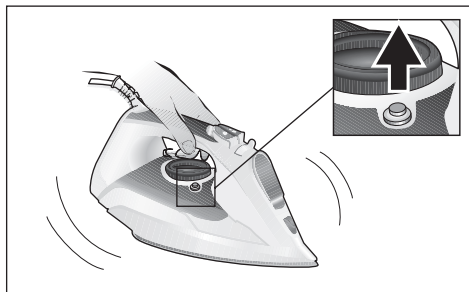

- 7 Repeat the steps 5 and 6 three times until the tank is empty.

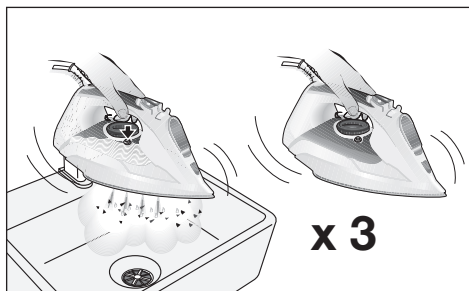

- 8 Then plug the iron in and heat it up again until the remaining water has evaporated. Push the “clean” button a few times more to clean the valve.

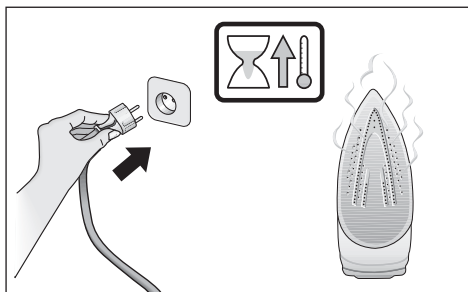

- 9 Unplug the iron and let the soleplate (7) cool down. Wipe the soleplate with a damp cotton cloth only.

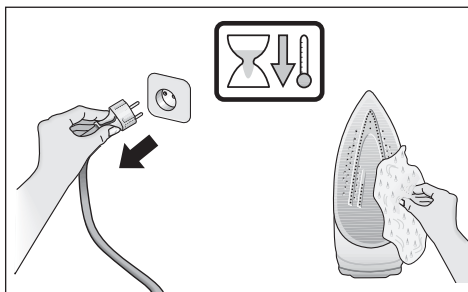

C “Calc’nClean” with descaling liquid *

For deep descaling, it is recommended to use the descaling liquid especially developed by Bosch. This procedure should be carried out every 3 months.

1. Fill the water tank (11) with tap water mixed with a measure (25 ml) of the descaling liquid (17 *).
2. Then follow the procedure described above in section “Calc’nClean” (steps 2 to 9).

The descaling liquid may be purchased from our after-sales service or specialist shops.

Name of accessory: TDZ1101

* Model dependent

D anti-calc*

The “anti-calc” cartridge has been designed to reduce the build-up of scale produced during steam ironing, helping to extend the useful life of your iron. Nevertheless the “anti-calc” cartridge cannot remove all of the scale that is produced naturally over time.



“TextileProtect” fabric protector *

*The fabric protector (16 *) is used for steam-ironing delicate garments at maximum temperature without damaging them.*

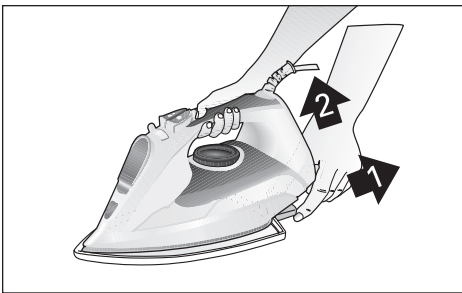
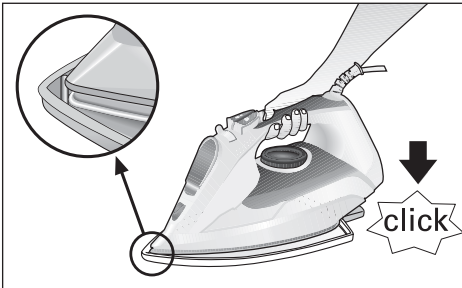

The fabric protector may be purchased from our after-sales service or specialist shops.

Name of accessory: TDZ1550



“StoreProtect” *

*The “StoreProtect” accessory (18 *) enables an immediate and safe storage of the iron, even with a hot soleplate (7).*

This accessory may be purchased from our after-sales service or specialist shops.

Name of accessory: TDZ1750



Trouble shooting

Problem	Probable cause	Solution
The iron does not heat up.	<ol style="list-style-type: none">1. Temperature control (12) set to minimum.2. The "secure"* system has been activated ("auto off" indicator lamp 15* flashes). The iron is set to stand-by.	<ol style="list-style-type: none">1. Turn to a higher position.2. To reconnect the iron, just move it about gently.
The clothes tend to stick	<ol style="list-style-type: none">1. The temperature is too high.	<ol style="list-style-type: none">1. Turn the temperature control (12) down and wait until the iron has cooled down.
Water drips out of the soleplate (7) together with steam.	<ol style="list-style-type: none">1. Temperature control (12) setting is too low.2. Steam regulator (3) is set too high in conjunction with a low temperature.3. You have pressed the shot of steam button (2) repeatedly without waiting for 5 seconds between each press.	<ol style="list-style-type: none">1. Turn the temperature control to a higher setting (between "••" and "max") and wait until the pilot light (13) goes out.2. Set the steam regulator (3) to a lower setting.3. Wait 5 seconds between each press of the shot of steam button.
Steam does not come out.	<ol style="list-style-type: none">1. Steam regulator (3) is set to  position.2. The temperature is too low. Anti-drip system is activated.	<ol style="list-style-type: none">1. Set the steam regulator to a higher position.2. Set to a higher temperature if compatible with the fabric.
Smoke comes out when connecting the iron for the first time.	<ol style="list-style-type: none">1. This may be caused by the lubrication of some of the internal parts.	<ol style="list-style-type: none">1. This is normal and will stop after a few minutes.
Excessive dripping or steaming.	<ol style="list-style-type: none">1. No proper closing of "Calc'nClean" system.	<ol style="list-style-type: none">1. Actuate a few times the "clean" button (10).
Deposits come out through the holes in the soleplate (7).	<ol style="list-style-type: none">1. Traces of lime scale are coming out of the steam chamber.	<ol style="list-style-type: none">1. Carry out a cleaning cycle (see "Calc'nClean" section).

If none of the above solves the problem, get in touch with an authorised technical service.

Guarantee conditions

The terms of the guarantee for this appliance are in accordance with that stated by our representative for the country in which it is sold.

The details of these conditions can be obtained from the retailer from whom the appliance was purchased. The purchase receipt must be presented when making any claims against the terms of this guarantee.



Customer Service

Great Britain

Bosch Customer Service

Grand Union House

Old Wolverton Road Milton Keynes

MK12 5PT

UK +44 (0)344 892 8979

IRL +353 (0)1450 2655

www.bosch-home.co.uk