

HOOVER

JOVIS CORDED

INSTRUCTION MANUAL



GENERATION FUTURE

INSTRUCTIONS FOR SAFE USE

This appliance should only be used for domestic cleaning, as described in this user guide. Please ensure that this guide is fully understood before operating the appliance.

Do not leave the appliance plugged in. Always switch off and remove the plug from the socket after use, or before cleaning the appliance or any maintenance task.

This appliance can be used by children aged from 8 years and above and persons with reduced physical, sensory or mental capabilities or lack of experience and knowledge if they have been given supervision or instruction concerning use of the appliance in a safe way and understand the hazards involved. Children shall not play with the appliance. Cleaning and user maintenance shall not be made by children without supervision.

If the power cord is damaged stop using the appliance immediately. To avoid a safety hazard, an authorised Hoover service engineer must replace the power cord.

Keep hands, feet, loose clothing and hair away from rotating brushes.

Use only attachments, consumables or spares recommended or supplied by Hoover.

Static electricity: some carpets can cause a small build up of static electricity. Any static discharge is not hazardous to health.

Do not use your appliance out of doors or on any wet surface or for wet pick up.

Do not pick up hard or sharp objects, matches, hot ashes, cigarette ends or other similar items.

Do not spray with or pick up flammable liquids, cleaning fluids, aerosols or their vapours.

Do not run over the power cord when using your appliance or remove the plug by pulling on the power cord.

Do not continue to use your appliance if it appears faulty.

Hoover service: To ensure the continued safe and efficient operation of this appliance we recommend that any servicing or repairs are only carried out by an authorised Hoover service engineer.

Do not stand on or wrap the cord around arms or legs when using your appliance.

Do not use the appliance to clean animals or people.

The Environment

The symbol on this appliance indicates that this appliance may not be treated as household waste. Instead it must be handed over to the applicable collection point for the recycling of electrical and electronic equipment. Disposal must be carried out in accordance with local environmental regulations for waste disposal. For more detailed information about treatment, recovery and recycling of this appliance, please contact your local city office, your household and waste disposal service or the shop where you purchased the appliance.



CE This appliance complies with the European Directives 2006/95/EC, 2004/108/EC and 2011/65/EU.

HOOVER Limited, Pentrebach, Merthyr Tydfil, Mid Glamorgan, CF48 4TU, UK

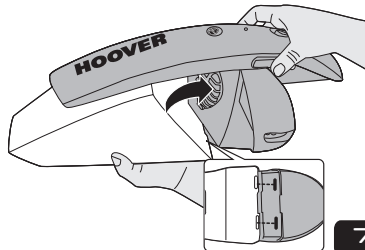
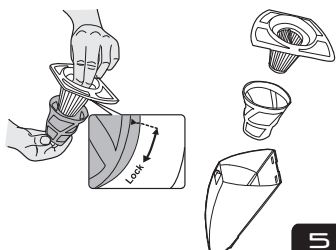
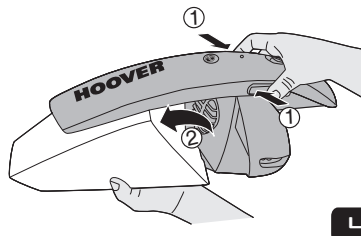
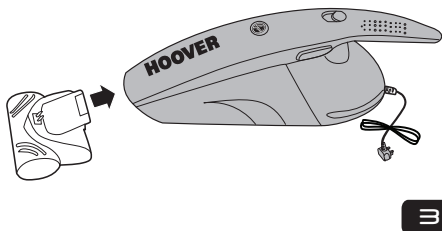
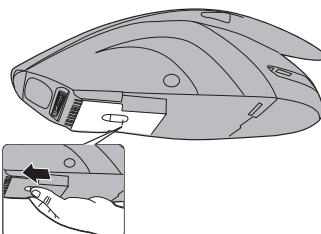
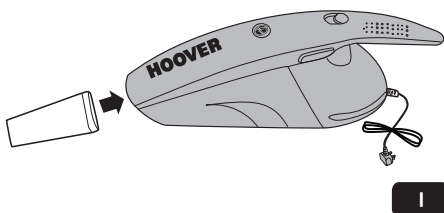
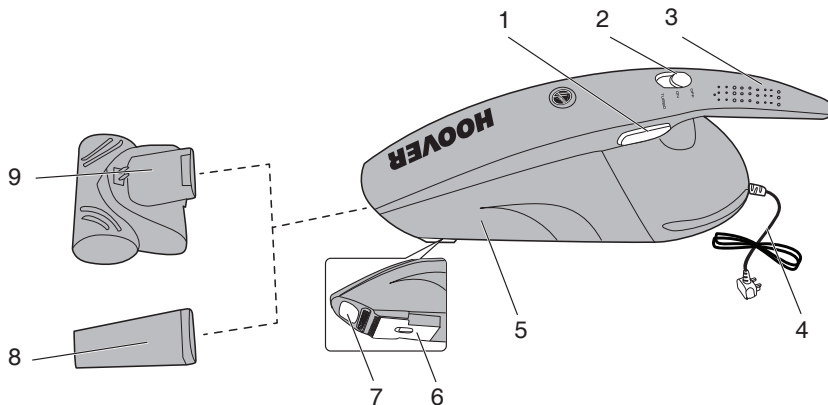

FEATURES

1. Dust Cup Release Button
2. On / Off Switch (3 position)
3. Handle
4. Power Cord & Plug
5. Dust Cup
6. Retractable Bristle
7. Dust Cup Inlet
8. Crevice Tool
9. Power Nozzle

HOW TO USE

Plug into mains power supply socket, Push the on/off switch to the power on position and when finished pull back to turn off.

ACCESSORIES

- **Crevice Tool (See Fig. 1)**
Fit the crevice tool into the dust cup inlet to clean area's difficult to reach.
- **Retractable Bristle (See Fig. 2)**
Ideal for cleaning delicate surfaces such as computer or piano keyboards. To use: Slide forwards or backwards to retract.
- **Power Nozzle (See Fig. 3)**
Ideal for cleaning carpet surfaces, please ensure that the nozzle is well connected prior to using . Push On/Off switch to Turbo Position.

DUST CONTAINER & FILTER REMOVAL OR REPLACEMENT (See Fig. 5, 6 & 7)

IMPORTANT: For optimum performance, clean the filter after every use. To access the filters and dust cup, hold the cleaner in a vertical position, press the dust release button located on the side of the handle. This releases the dust cup from the main body. Hold the dust cup to remove the filter, clean all debris from the filter, empty the container. Replace the filter back into the dust cup and reassemble container to the cleaner .

HOOVER Service

Should you require service at any time, please contact your local Hoover service office. Spare parts are available direct from HOOVER, when ordering parts always quote your model number.

Consumables

- HEPA filter and mesh shroud: S91_35600832

Quality

HOOVER's factories have been independently assessed for quality. Our products are made using a quality system which meets the requirements of ISO 9001.

GUARANTEE STATEMENT

The guarantee conditions for this appliance are as defined by our representative in the country in which it is sold. Details regarding these conditions can be obtained from the dealer from whom the appliance was purchased. The bill of sale or receipt must be produced when making any claim under the terms of this guarantee.

Subject to change without notice.



®

GENERATION FUTURE

PRINTED IN P.R.C.
48008295