



Zoom

User Guide

U87-ZM-B / U87-ZM-P / U87-ZM-R / U87-ZM-PF



Contents

Contents	1
Machine Overview	2
General Safety Information	3
Getting Started	4
How To Use	5
Looking After Your Machine – Filters and Dirt Container	6
Looking After Your Machine – Filters	7
Looking After Your Machine – Removing Blockages	8
Looking After Your Machine – Brushbar	9
FAQs	10
Other Information	11
Guarantee	12

Machine Overview

- 1 Handle
- 2 Telescopic extension tube
- 3 Dirt container release button
- 4 Power on/off button
- 5 Separator
- 6 Dirt container
- 7 Hose holder
- 8 Post-motor filter cover
- 9 Hose to machine connector
- 10 Carpet height adjuster
- 11 TurboTool holder
- 12 Handle release button
- 13 Quick release cord wrap
- 14 Hose
- 15 Cord
- 16 Flexi crevice tool
(available with U87-ZM-PF)
- 17 Fur & Fluff tool
(available with U87-ZM-PF)
- 18 3-in-1 crevice, dust and upholstery tool
- 19 TurboTool
(available with U87-ZM-P, U87-ZM-PF, U87-ZM-R)
- 20 Pre-motor filter
- 21 Post-motor filter

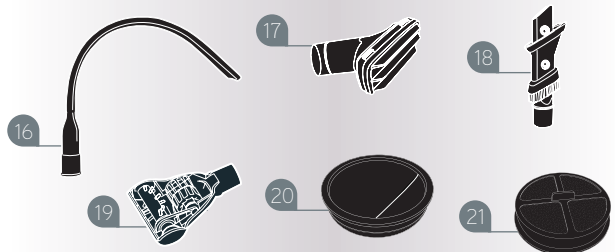

NOTE: Some parts may vary according to model. Please check inside flap of box for more details.

General Safety Information

This vacuum cleaner is intended for household use only and NOT for commercial or industrial use. Please keep instructions for further use.

When using the vacuum cleaner basic safety precautions should always be observed, including the following:

1. Only use the vacuum cleaner indoors on dry surfaces.
2. Turn off the on/off switch on the vacuum cleaner controls before disconnecting or connecting from the mains supply.
3. Always unplug the vacuum cleaner before connecting or disconnecting the vacuum hose and accessories.
4. Children should be supervised to ensure that they do not play with the appliance.
5. This appliance is not intended for use by children under eight years of age and persons with reduced physical, sensory or mental capabilities or lack of experience and knowledge, unless they have been given supervision or instruction concerning use of the appliance in a safe way and understands the hazards involved.
6. Cleaning and maintenance shall not be made by children without supervision.
7. The appliance should only be used as described in the quick start guide or in the full online user guide.
8. Only Vax recommended attachments should be used with this appliance.
9. Do not use this vacuum cleaner if it has been dropped, damaged, left outdoors or dropped into water. Do not use this vacuum cleaner with a damaged cord or plug. If the supply cord is damaged return the vacuum cleaner to Vax for examination, repair or adjustment.
10. Do not pull or carry this appliance by the cord. Do not use the cord as a handle, close a door on the cord or pull the cord around sharp edges or corners. Do not run the vacuum cleaner over the cord. Keep the cord away from heated surfaces.
11. Do not handle the plug or the vacuum cleaner with wet hands.
12. Keep hair, loose clothing, fingers and all parts of the body away from openings and moving parts.
13. Do not pick up any hot coals, cigarette butts, matches or any hot, smoking or burning objects.
14. Do not pick up any flammable or combustible materials (lighter fluid, petrol, kerosene etc.) or use in the presence of explosive liquids or vapours.
15. Do not vacuum up harmful or toxic material (chlorine, bleach, ammonia, drain cleaner etc.).
16. Do not vacuum up hard or sharp objects such as glass, nails, screws, coins etc.
17. Store the vacuum cleaner in a cool, dry area.
18. Use only CE approved 13 amp extension cords. Non-approved cords may overheat. Care should be taken to arrange the cord so that the cord cannot be tripped over.
19. Do not put any objects into openings. Do not use with any openings blocked and do not restrict airflow. Keep all openings free of dust, lint, hair or anything that might reduce airflow.
20. Do not use without all of the filters in place.
21. Take extra care when positioning the vacuum cleaner on the stairs.
22. Please ensure that the brushbar is turned off when you are vacuuming on the stairs.
23. Keep vacuuming area well lit.

Getting Started

PLEASE READ SAFETY INFORMATION BEFORE USE (p3)

Before plugging the cord into the electrical outlet, make sure the switch is in the 'off' position. Hold the vacuum cleaner firmly when starting and in use.

Assembling your upright

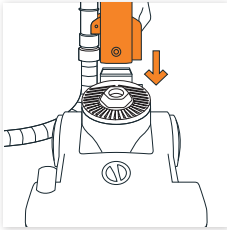

Insert the backbone into the floorhead.

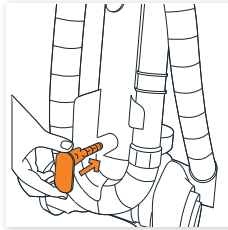

Insert the cord holder into the hole at the bottom of the product backbone.

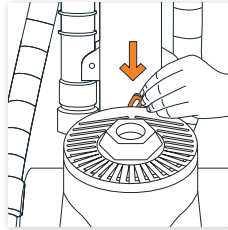

Now take the small clip and push it down between the end of the cord holder and the machine, to lock the cord holder in place.

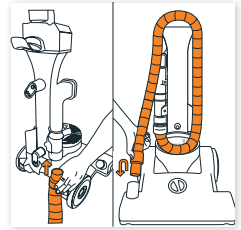

1. Insert the short end of the hose into the tube at the back of the machine.
2. Wrap the hose around the machine and connect the hose end to the floorhead.

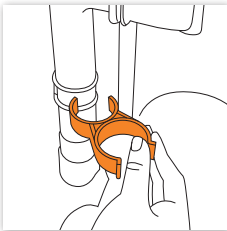

Attach hose clip to the air inlet tube.

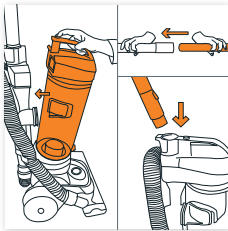

1. Place the dirt container onto the product and click in place to secure.
2. Store the extension tube in to the handle then Insert the handle at the top of the product.

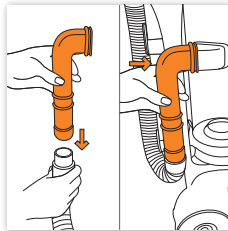

Hose connector fits into the air inlet tube bayonet.

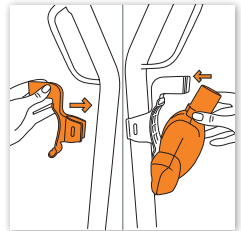

1. Attach TurboTool clip to the handle
2. Snap TurboTool into position.

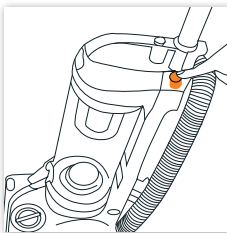

Plug in and switch on your machine.

How To Use

NOTE: Please select the hard floor setting on the brushbar height adjustment dial when using on hard floor, vinyl or lino to ensure the brushbar is in the highest position to avoid damaging your floor.

NOTE: This unit has a constantly rotating brushbar. The Height Adjust dial must be set to the highest mode before using the hose and attaching accessories.

How to use

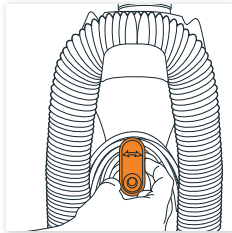

Twist the cord holder to release the cord.

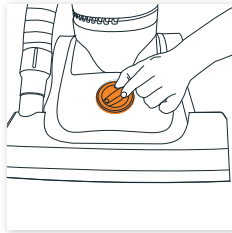

Choose your desired carpet height or hardfloor setting.

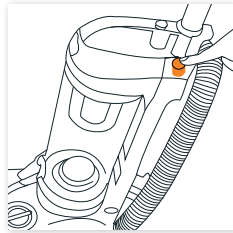

Plug in your machine and turn it on.

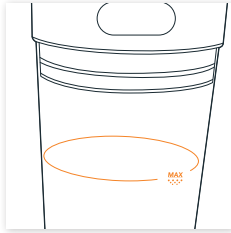

Don't over fill the container to avoid clogging your filter.

Using accessories

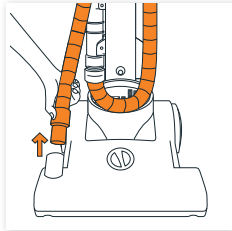

Remove hose end from the floorhead.

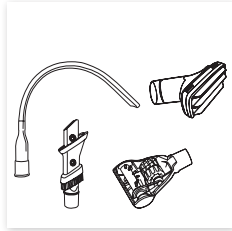

Choose an accessory.



Attach accessory adapter to hose end.

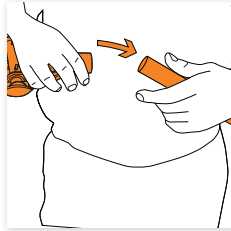

Attach accessory to hose end.

Telescopic extension tube

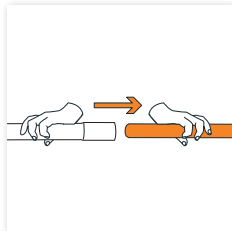

Remove telescopic extension tube from inside product handle.

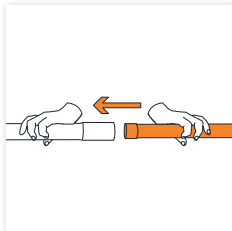

Turn the telescopic tube and attach to the handle.

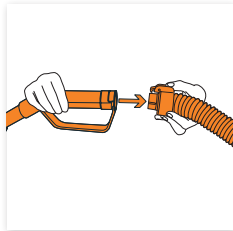

Attach hose to top of product handle.

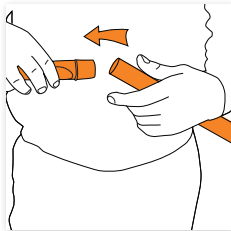

Attach accessory to telescopic extension tube.

Looking After Your Machine – Filters and Dirt Container

NOTE: Wash filters with warm water (40°C max) at least every 3 months for best cleaning results. For detailed information on maintaining your vacuum cleaner and its filters, please refer to the full user guide at vax.co.uk/support

Emptying and cleaning the dirt container

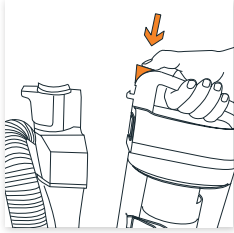

Press dirt container release button to remove the dirt container.

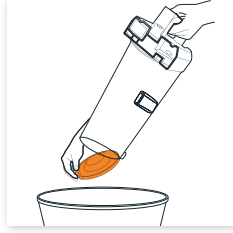

Hold dirt container over a bin and unclip the lock on the bottom of the dirt container, allowing the dirt to fall out.

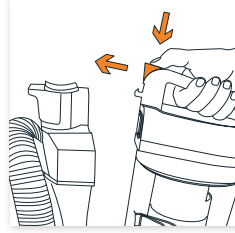

Close the base of the dirt container and click dirt container back onto the product.

Cleaning the pre-motor filter



Turn the dirt container lid anti-clockwise to remove.

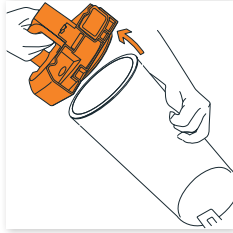

Remove the dirt container lid.



Use the tab on the filter to pull the filter out of its housing.

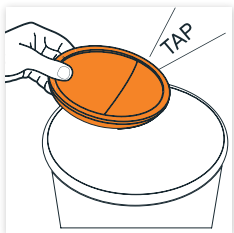

Tap the filter over a bin to release and dirt.



Wash the filter under running water (40 degree max).

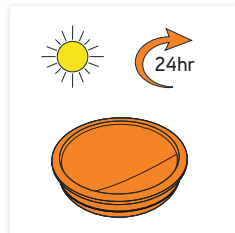

Leave to dry for 24 hours and then replace before using your vacuum.

Looking After Your Machine – Filters

Cleaning the shroud

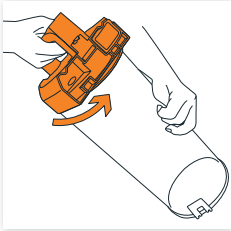

Turn the dirt container lid anti-clockwise to remove.

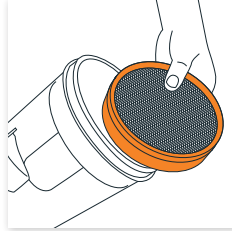

Remove the pre-motor filter to allow access to the shroud.

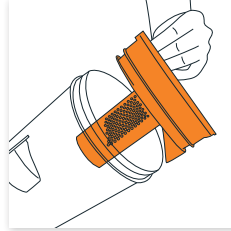

Tap the shroud over a bin to release dirt.

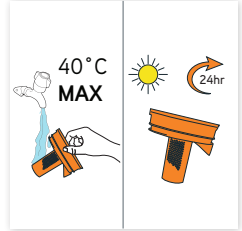

Wash the shroud under running water and leave to dry. The shroud will need to be placed back properly.

Cleaning the post-motor filter

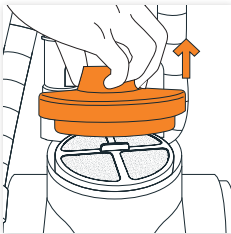

Remove the exhaust cover under the bin to find the post-motor filter.

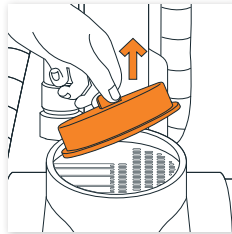

Remove the filter.



Tap the post-motor filter over a bin to release the dirt.



Wash the filter under running water (40 degree max)

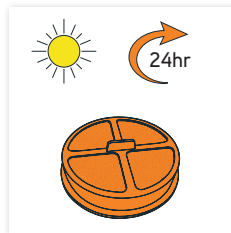

Leave to dry for 24 hours and then replace before using your vacuum.

Looking After Your Machine – Removing Blockages

IMPORTANT: If the air inlet, hose or telescopic tube is blocked, switch off the vacuum cleaner and remove the blockage(s) before re-starting the vacuum cleaner.

Removing debris from the brushbar

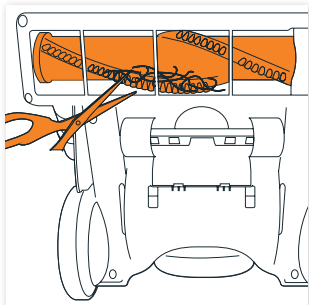

Switch off your vacuum cleaner at the main socket. Using a pair of scissors cut any hair or debris free from around the brushbar.

Removing blockages from the TurboTool

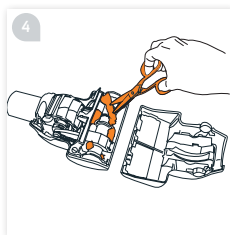
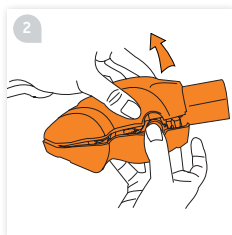
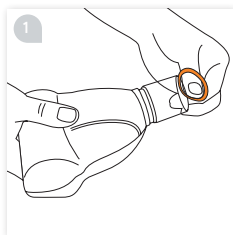

Looking After Your Machine – Brushbar

Changing the belt

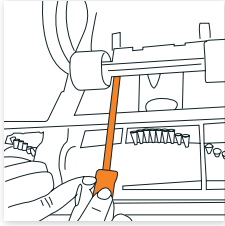

Switch off your vacuum cleaner at the main socket and unplug. Unclip the 2 small wheels from the base of the vacuum to enable you to remove the screws from behind.

Note: The screw for the height adjuster dial is located here.

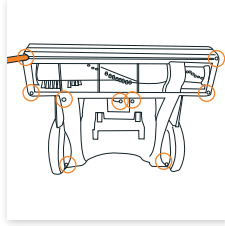

Remove the 9 screws from the base of the floorhead cover.

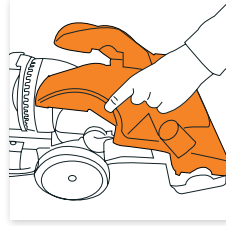

Remove the floorhead cover.

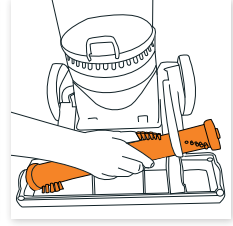

Lift the brushbar from the machine to remove the belt. Note: To remove debris from the brushbar see page 8.

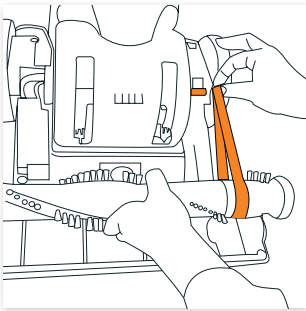

Place the belt by attaching it to the brushbar and hooking it onto the metal side.

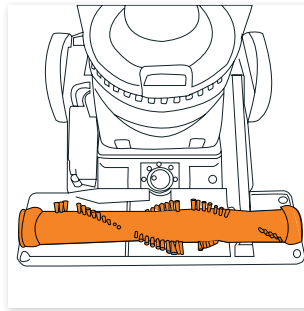

Once the belt has been replaced attach the brushbar back onto the vacuum.



Attach the floorhead cover, 2 small wheels and height adjuster dial by screwing back into place.

Warning: To reduce the risk of personal injury, unplug the vacuum cleaner before performing maintenance/troubleshooting checks.

Is there an accessory missing?

- Check the 'Getting Started' page in this guide or the box that the machine came in to make sure that the part is definitely included in your unit.
- If it is missing, we're here to help. Simply call us on **0844 412 8455**

Why won't the vacuum cleaner pick up?

- The filters may need cleaning, please refer to the 'Looking After Your Machine – Filters' page of this user guide (p6-7)
- The separator may be clogged, please refer to the 'Looking After Your Machine – Filters' page of this user guide (p6-7)
- There may be a blockage in the hose, please check the hose and remove the blockage
- The dirt container may be full or blocked, please refer to the 'Looking After Your Machine – Emptying and cleaning dirt container' page of this user guide (p6)
- The dirt container may be incorrectly installed, please ensure the dirt container is locked in place
- The brushbar may not be turning, please refer to the 'Looking After Your Machine Brushbar' page 9

Why won't the accessories pick up properly?

- The TurboTool may be blocked, please refer to the 'Looking After Your Machine – Removing Blockages' page in this user guide (p8)
- The accessory may be broken

What do I do if an accessory/the unit becomes damaged or broken?

- Please check if the damage is with the accessory or the unit. To do this, firstly remove the accessory from the unit and check if there is suction from the hose. If there is suction from the hose this confirms that the damage is with the accessory.
Please visit 'spares shop website' – vax.co.uk/support
- If having done the above checks, checked the hose for blockages and cleaned the filters there is still no suction/limited suction from the hose, please call our Vax Careline 0844 412 8455

Why is dust escaping from the vacuum?

- The filters may not be installed correctly, please refer to the 'Looking After Your Machine – Filters' page of the user guide (p6-7)
- The dirt container may be full or blocked, please refer to the 'Looking After Your Machine – Emptying and cleaning dirt container' page of this user guide (p6)
- The filters may need cleaning, please refer to the 'Looking After Your Machine – Filters' page of this user guide (p6-7)
- There may be a blockage in the hose, please check the hose and remove the blockage

Why does my vacuum cleaner have no power?

- It may not be plugged into the electrical socket correctly. Ensure that the plug is pushed into the electrical socket securely
- The electrical socket may not be working. Check the fuse or breaker and consult an electrician
- The motor thermostat may have tripped. Switch off and unplug the vacuum cleaner. Check the unit for blockages, clean the filters – please refer to the 'Looking After Your Machine – Filters' page of this user guide (p6-7) and clean the separator (please refer to the 'Looking After Your Machine – Emptying and cleaning dirt container' page of this user guide (p6). Leave the vacuum cleaner for 24 hours before switching the vacuum cleaner back on

Why isn't my brushbar rotating?

- The belt may be broken
- The brushbar may be jammed. Please refer to the 'Looking After Your Machine – Removing Blockages' page of this user guide and remove any blockages (p8)

Why does the vacuum cleaner cut out?

- The motor is equipped with a thermal cut-out. If for any reason the unit should overheat, the thermostat will automatically turn the unit off. Should this occur, unplug the vacuum cleaner from the electrical socket and turn off the switch. Remove and empty the dirt container. Check the hose for blockages. Clean the filters. Allow the unit to cool for approximately 1 hour (if you have cleaned the filters you will need to wait 24 hours for the filters to dry before putting them back in the machine)

What do I do if the unit becomes damaged or broken?

- We're here to help. Simply call **0844 412 8455** or visit vax.co.uk

Other Information

UK Service & Help

Any queries or concerns about using your Vax, simply visit; vax.co.uk/support – vaxireland.ie or call the Vax Careline. Calls are charged at the UK local rate. Please have your machine with you when calling.

Vax Careline:
(UK) 0844 412 8455
(ROI) 1-800 928 308

Monday-Friday 8.30am to 6.30pm
Saturday-9.00am to 5.00pm

Consumables

To purchase spares and accessories, please visit vax.co.uk

The use of genuine vax spare parts helps to maintain optimised performance and validates your guarantee

3-in-1 tool (Type 1): 1-1-129167-00
TurboTool (Type 1): 1-1-126261-00
Flexi crevice tool (Type 1): 1-1-131393-00
Fur and Fluff tool (Type 1): 1-1-131392-00
Adapter: 1-1-128056-00



Technical Specification

Voltage: 220-240V -50Hz
Filters: Pre-motor filter (washable)
HEPA (anti-bacterial) Post-motor filter

Subject to technical change without notice.



EEC Statement of Compliance

Manufacturer/EEC importer: Vax Limited, hereby on our own responsibility, declare that the **U87-ZM** series is manufactured in compliance with the following Directives:

Safety: 2006/95/EC Low Voltage Directive

EMC: 2004/108/EC Electromagnetic Compatibility Directive



Waste electrical products should not be disposed of with household waste. Please recycle where facilities exist. Check with your Local Authority or retailer for recycling advice.

Guarantee

It's quick and easy to register for your
FREE 2 year guarantee
online at: vax.co.uk/guarantees

Please retain your original receipt for proof of purchase.

UK based customer care centre — Open 6 days a week

Monday-Friday 8:30am-6:30pm

Saturday 9:00am-5:00pm

we're here if you need us

Instead of taking me back to the shop, simply visit:
vax.co.uk/support or call (UK) 0844 412 8455 (ROI) 1-800 928 308

Let us know what you think @VaxUK 



**2 year
guarantee**





Vax Ltd., Kingswood Road, Hampton Lovett, Droitwich, Worcestershire, WR9 0QH, UK
email: info@vax.co.uk website: vax.co.uk