



Freezer user manual

**Planet
First** 100 %
Recycled Paper

This manual is made with 100 % recycled paper.

imagine the possibilities

Thank you for purchasing a Samsung product.

Free Standing Appliance



Contents

SAFETY INFORMATION	2
SETTING UP YOUR FREEZER	11
OPERATING YOUR FREEZER	17
TROUBLESHOOTING	22

Safety information



SAFETY INFORMATION

- Before operating the appliance, please read this manual thoroughly and retain it for your reference.
- Use this appliance only for its intended purpose as described in this instruction manual. This appliance is not intended for use by persons (including children) with reduced physical, sensory or mental capabilities, or lack of experience and knowledge, unless they have been given supervision or instruction concerning use of the appliance by a person responsible for their safety.
- This appliance can be used by children aged from 8 years and above and persons with reduced physical, sensory or mental capabilities or lack of experience and knowledge if they have been given supervision or instruction concerning use of the appliance in a safe way and understand the hazards involved.
Children shall not play with the appliance. Cleaning and user maintenance shall not be made by children without supervision.
- Because these following operating instructions cover various models, the



characteristics of your freezer may differ slightly from those described in this manual.





- It is hazardous for anyone other than an Authorised Service Person to service this appliance. In Queensland – the authorized Service Person **MUST** hold a Gas Work Authorisation or Licence for hydrocarbon refrigerants, to carry out Servicing or repairs which involve the removal of covers. (For Australia only)

Important safety symbols and precautions:

	Hazards or unsafe practices that may result in severe personal injury or death.
	Hazards or unsafe practices that may result in minor personal injury or property damage.

OTHER SYMBOLS USED

	Do NOT attempt.
	Do NOT disassemble.
	Do NOT touch.

	Follow directions carefully.
	Unplug the power plug from the wall socket.
	Make sure the machine is grounded to prevent electric shock.
	Call the contact center for help.
	Note.

These warning signs are here to prevent injury to you and others.

Please follow them explicitly.

After reading this section, keep it in a safe place for future reference.

CE Notice

This product has been determined to be in compliance with the Low Voltage Directive (2006/95/EC), the Electromagnetic Compatibility Directive (2004/108/EC), RoHS Directive (2011/65/EU), Commission Delegated Regulation (EU) No 1060/2010 and the Eco-Design Directive(2009/125/EC) implemented by Regulation (EC) No 643/2009 of the European Union. (For products sold in European Countries only)



SEVERE WARNING SIGNS FOR INSTALLATION

-  • Do not install the freezer in a damp place or place where it may come in contact with water.
- Deteriorated insulation of electrical parts may cause an electric shock or fire.
- Do not place this freezer in direct sunlight or expose to the heat from stoves, room heaters or other appliance.
- Never use gas pipes, telephone lines or other potential lightening rods as ground.
- Improper use of the ground plug can result in electric shock.
- Do not plug several appliances into the same multiple power board. The freezer should always be plugged into its own individual electrical which has a voltage rating that matched the rating plate.
- This provides the best performance and also prevents overloading house wiring circuits, which could cause a fire hazard from overheated wires.
- Do not use a cord that shows

cracks or abrasion damage along its length or at either end.

- Do not bend the power cord excessively or place heavy articles on it.
-
-  • This freezer must be properly installed and located in accordance with the manual before it is used.
 - If the wall socket is loose, do not insert the power plug.
 - There is a risk of electric shock of fire.
 - Connect the power plug in proper position with the cord hanging down.
 - If you connect the power plug upside down, wire can get cut off and cause fire or electric shock.
 - When moving the freezer, be careful not to roll over or damage the power cord.
 - This constitutes a fire hazard.
 - Make sure that the power plug is not squashed or damaged by the back of the freezer.
 - Keep the packing materials out of reach of children.
 - There is a risk of death from suffocation if children put them on their head.

- The appliance must be positioned so that the plug is accessible after installation.



- The freezer must be grounded.
- You must ground the freezer to prevent any power leakages or electric shocks caused by current leakage from the freezer.



- If the power cord is damaged, have it replaced immediately by the manufacturer or its service agent.
- The fuse on refrigerator must be changed by a qualified technician or service company.
- Failing to do so may result in electric shock or personal injury.



CAUTION SIGNS FOR INSTALLATION

- Keep ventilation opening in the appliance enclosure or mounting structure clear of obstruction.
- Allow the appliance to stand for 2 hours after installation.



SEVERE WARNING SIGNS FOR USING





- Do not insert the power plug with wet hands.
- Do not store articles on the top of the appliance.
- When you open or close the door, the articles may fall and cause personal injury and/or material damage.
- Do not put a container filled with water on the freezer.
- If spilled, there is a risk of fire or electric shock.
- Do not let children hang on the door. If not, a serious injury may occur.
- Do not let children enter inside of the freezer. There is a risk of children entrapment.
- Do not touch the inside walls of the freezer or products stored in the freezer with wet hands.
- This may cause frostbite.
- Do not store volatile or flammable substances in the freezer.
- The storage of benzene, thinner, alcohol, ether, LP gas and other such products may cause explosions.
- Do not store pharmaceuticals products, scientific materials or temperature sensitive

products in the freezer.

- Products that require strict temperature controls must not be stored in the freezer.
- Do not place or use electrical appliance inside the freezer, unless they are of a type recommended by the manufacturer.

-
-  • Do not use mechanical devices or any other means to accelerate the defrosting process, other than those recommended by the manufacturer.

-
-  • Do not damage the refrigerant circuit.
 - Do not disassemble or repair the freezer by yourself.
 - You run risk of causing a fire, malfunction and/or personal injury.

-
-  • Children should be supervised to ensure that they do not play with the appliance.
 - This product is intended only for the storage of food in a domestic environment.
 - If a gas leak is detected, avoid any naked flames or potential

sources of ignition and air the room in which the appliance is standing for several minutes.

- Use only the LED Lamps provided by manufacturer or service agents.

-
-  • If you smell pharmaceutical or smoke, pull out power plug immediately and contact your Samsung Electronics service center.

- If the products equipped with LED Lamp, do not disassemble Lamp Cover and LED Lamp by yourself.
- Please contact your service agents.



CAUTION SIGNS FOR USING

-
-  • Do not place carbonated or fizzy drinks in the freezer compartment. Do not put bottles or glass containers in the freezer.
 - When the contents freeze, the glass may break and cause personal injury.

- ★ • To get Best performance of product,
 - Do not place foods too closely in front of the vents at the rear of the appliance as it can obstruct free air circulation in the freezer compartment.
 - Wrap the food up properly or place it in airtight containers before put it into the freezer.
 - Do not put any newly introduced food for freezing near to already food.
 - Please observe maximum storage times and expiry dates of frozen goods.
 - There is no need to disconnect the freezer from the power supply if you will be away for less than three weeks. But, Remove all the food if you are going away for the three weeks or more. Unplug the freezer and clean it, rinse and dry.
 - Fill water tank, ice tray, water cubes only with potable water.
-
- ✍ • If the freezer is damaged by water, pull out the power plug and contact your Samsung Electronics service center.
 - Do not apply strong shock or excessive force onto the surface of glass.
 - Broken glass may result in a personal injury and/or property damage.
-
- 

CAUTION

CAUTION SIGNS FOR CLEANING
-
- ☒ • Do not directly spray water inside or outside the freezer.
 - There is a risk of fire or electric shock.
 - Do not spray inflammable gas near the freezer.
 - There is a risk of explosion or fire.
-
- ★ • Remove any foreign matter or dust from the power plug pins. But do not use a wet or damp cloth when cleaning the plug, remove any foreign material or dust from the power plug pins.
 - Otherwise there is a risk of fire or electric shock.
 - Do not spray cleaning products directly on the display.
 - Printed letters on the display may come off.
-



- Unplug the freezer before cleaning and making repairs.



SEVERE WARNING SIGNS FOR DISPOSAL



- When disposing of this or other freezers, remove the door/door seals, door latch so that small children or animals cannot become trapped inside. Children should be supervised to ensure that they do not play with the appliance.
- Please dispose of the packaging material for this product in an environmentally friendly manner.
- Leave the shelves in place so that children may not easily climb inside. Ensure that none of the pipes on the back of the appliance are damaged prior to disposal.
- R-600a or R-134a is used as a refrigerant. Check the compressor label on the rear of the appliance or the rating label inside the freezer to see which refrigerant is used for your freezer. When this product contains flammable gas (Refrigerant R-600a), contact your local authority in regard to safe disposal of this product. Cyclopentane is used as a insulation blowing gas. The gases in insulation material require special disposal procedure. Please contact your local authorities in regard to the environmentally safe disposal of this product. Ensure that none of the pipes on the back of the appliances are damaged prior to disposal. The pipes shall be broke in the open space.
- If the appliance contains iso-butane refrigerant (R-600a), a natural gas with high environmental compatibility that is, however, also combustible. When transporting and installing the appliance, care should be taken to ensure that no parts of the refrigerating circuit are damaged.
- Refrigerant squirting out of the pipes could ignite or cause an eye injury. If a leak is detected, avoid any naked flames or potential sources of ignition and air the room in which the appliance is standing for several minutes.

- In order to avoid the creation of a flammable gas-air mixture if a leak in the refrigerating circuit occurs, the size of the room in which the appliance may be sited depends on the amount of refrigerant used. Never start up an appliance showing any signs of damage. If in doubt, consult your dealer. The room must be 1 m³ in size for every 8 g of R-600a refrigerant inside the appliance. The amount of refrigerant in your particular appliance is shown on the identification plate inside the appliance.
- If the key is provided with freezer, the keys should be kept out of the reach of children and not in vicinity of the appliance.
- The appliance might not operate consistently (possibility of defrosting of contents or temperature becoming too warm in the freezer) when sited for an extended period of time below the cold end of the range of temperatures for which the refrigerating appliance is designed.
- Your appliance is frost free, which means there is no need to manually defrost your appliance, as this will be carried out automatically.



ADDITIONAL TIPS FOR PROPER USAGE

- In the event of a power failure, call the local office of your Electricity Company and ask how long it is going to last.
- Most power failures that are corrected in an hour or two will not affect your freezer temperatures. However, you should minimize the number of door openings while the power is off.
- But Should the power failure last more than 24 hours, remove all frozen food.
- Temperature rising during the defrost can comply with ISO requirement. But If you want to prevent an undue rise in the temperature of the frozen food while defrosting the appliance, please wrap the frozen food in several layers of newspaper.
- Any increase in temperature of frozen food during defrosting can shorten its storage life.
- The temperature of two star section (sections) or compartment (compartments) which have two star symbol

(***) is slightly higher than other freezer compartment (compartments).

The two star section (sections) or compartment (compartments) is (are) based on the instruction and/or the condition as delivered.

Saving Energy Tips

- Install the appliance in a cool, dry room with adequate ventilation.
Ensure that it is not exposed to direct sunlight and never put it near a direct source of heat (radiator, for example).
- Never block any vents or grilles on the appliance.
- Allow warm food to cool down before placing it in the appliance.
- Put frozen food in the refrigerator to thaw.
You can then use the low temperatures of the frozen products to cool food in the refrigerator.
- Do not keep the door of the appliance open for too long when putting food in or taking food out. The shorter time for which the door is open, the less ice will form in the freezer.
- Clean the rear of the refrigerator regularly.

Dust increases energy consumption.

- Do not set temperature colder than necessary.
- Ensure sufficient air exhaust at the refrigerator base and at the back wall of the refrigerator.
Do not cover air vent openings.
- Allow clearance to the right, left, back and top when installing.
This will help reduce power consumption and keep your energy bills lower.
- For the most efficient use of energy, please keep the all inner fittings such as baskets, drawers, shelves on the position supplied by manufacturer.

This appliance is intended to be used in household and similar applications such as

- staff kitchen areas in shops, offices and other working environments;
- farm houses and by clients in hotels, motels and other residential type environments;
- bed and breakfast type environments;
- catering and similar non-retail applications.

Setting up your freezer

GETTING READY TO INSTALL THE FREEZER

Congratulations on your purchase of this Samsung Freezer.

We hope you enjoy the state-of-art features and efficiencies that this new appliance offers.

- This freezer must be properly installed and located in accordance with the manual before it is used.
- Use this appliance only for its intended purpose as described in this instruction manual.
- We strongly recommend that any servicing be performed by a qualified individual.
- Please dispose of the packaging material for this product in an environmentally friendly manner.



Pull the power plug out of the socket before changing the interior light of the freezer.
 - Otherwise, there is a risk of electric shock.

Selecting the best location for the Freezer

- A location without direct exposure to sunlight.
- A location with flat floor surface.
- A location with enough space for the freezer door to open easily.
- Allow sufficient space for air circulation of the internal cooling system. If the freezer does not have enough space, the internal cooling system may perform more.

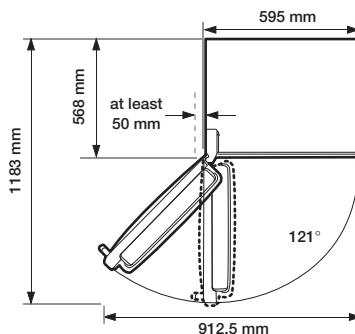
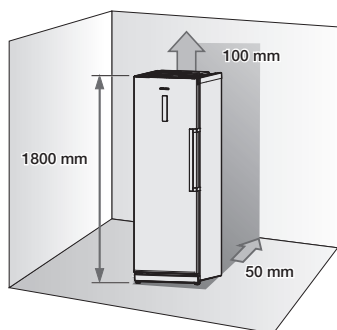

• Height of the product may be different depending on the models.

- Allow clearance to the right, left, back and top when installing. This will help reduce power consumption and keep your energy bills lower.
- Do not install the freezer in a place with the temperature lower than 10 °C.



Pull the unit straight out when installing, servicing or cleaning behind the freezer and push it straight back after work is complete. Make sure your floor can support fully loaded freezer.



Remove paper on spacer and then attach two spacers (Gray block) on the back side of refrigerator for better performance. Make sure two spacers fix like below image when you install the refrigerator. It is improving the refrigerator performance.

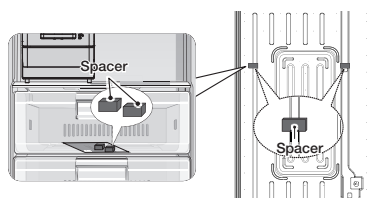

REVERSING THE FREEZER DOOR

WARNING Samsung recommends that reversing of the door opening is only completed by Samsung approved Service providers. This will be on a chargeable basis and at the customers expense.

! Any damage caused while attempting to reverse the door opening is not covered under the appliance manufactures warranty. Any repairs requested due to this circumstance will be completed on a chargeable basis at the customers expense.

Required Tools (Not provided)

Phillips Head Driver (+)	Flat Head Driver (-)	10 mm Socket Wrench (for bolts)
8 mm Socket Wrench (for bolts)	Spanner (for hinge shaft)	5 mm Hex Wrench (for bottom hinge shaft)

1. Remove 4 screws on the top of the freezer.

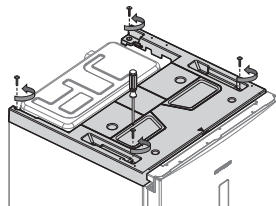

2. Remove the plastic cover and make sure to disconnect the wire connected to it. After removing the plastic cover, check the parts for reversing the door.

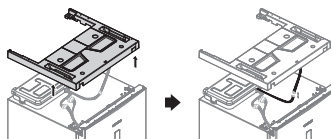

CAUTION Be careful not to damage the electrical wires when removing the plastic cover.

3. Disconnect the wires and then remove 3 bolts.

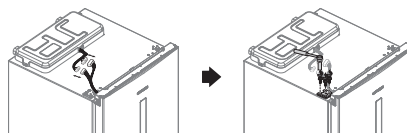

WARNING Make sure your freezer is unplugged before handling electrical wires.

- Remove the door from the lower hinge by carefully lifting the door straight up.

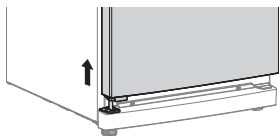

CAUTION Freezer door is heavy, be careful not to injure yourself when removing the freezer door.

- Separate the front leg cover after removing 2 screws.

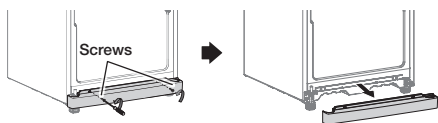

- Unscrew 3 bolts tightening the hinge and also unscrew 3 bolts on the bottom right side by the front leg where removed hinge will be attached.

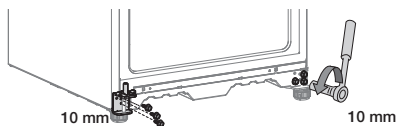

- Separate the hinge shaft by using hex wrench first. Unscrew the bolt to remove the hinge riser and switch the side of the hinge shaft and the hinge riser.

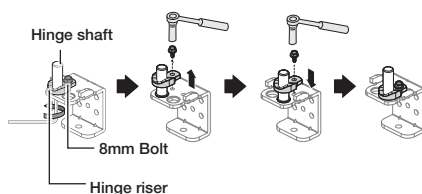

- Attach the hinge on the bottom right side of the freezer where bolts were previously removed in step 6. Screw the bolts that were removed on the bottom left side of the freezer for the future usage. Switch the the Leg from the left to right.

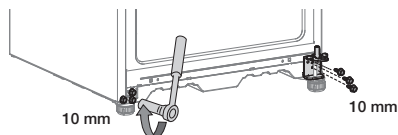

- Remove the screws on the bottom right and left side of the freezer door. Switch the side of the door stopper from left to the right. Hinge riser should be switched as well.

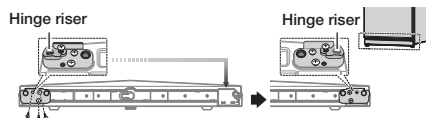

10. Remove the wire cover on top of the freezer door to switch the side of the wires.

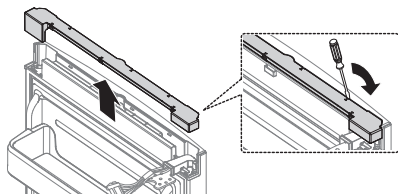

11. Remove the hinge and the grommet from the freezer door. Detach the left side hinge cover and pull the wires out of the hinge cover.

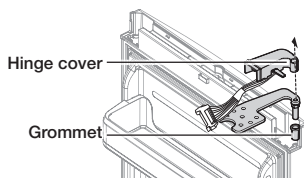

CAUTION Be careful not to damage the electrical wires when removing the hinge cover.

12. Use wrench to separate the hinge shaft and then flip the hinge and reattach the hinge shaft. And remove the shim at the top and attach it to the other side.

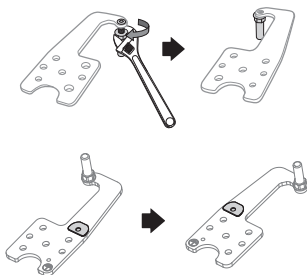

13. Reassemble the hinge on the freezer door by reversing the step 11. Make sure to use right side hinge cover (which can be found underneath the removed plastic cover from step 2) and remove the grommet. After reassembling the hinge, wire and the hinge cover, switch the side from left to the right.

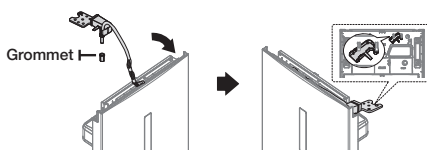

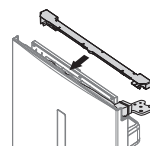

14. After switching the hinge, make sure to take out Cover Wire Door R in the packing and close it with the wire cover on the top of freezer door.

“Cover Wire Door R” can be found in the packaging

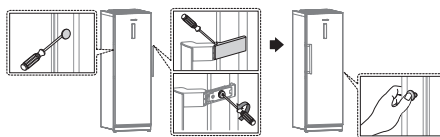

15. Take off the handle cover and remove the screws, make sure to detach the caps and the handle from the right to left side of the door. (Make sure to cover the right side with detached caps.)



 Handles may not have cover depending on the models.

16. Switch the hinge cap and attach the front leg cover. Carefully put the freezer door back on.

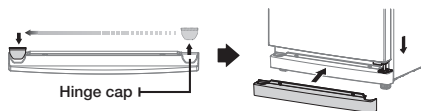

19. Tighten 4 screws back to its place.

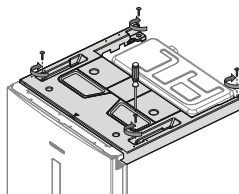

17. Tighten the 3 bolts and then connect the wires back together.

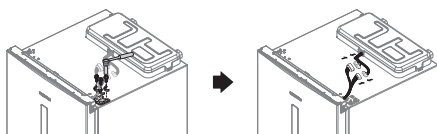

20. Detach the Freezer door gaskets and then attach them after rotating them 180°.

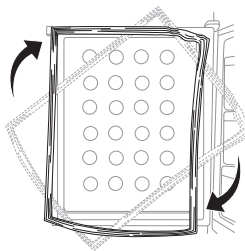

⚠ Make sure your freezer is unplugged before **WARNING** handling electrical wires.

18. Connect the wire on the plastic cover and put the cover back to its original position.

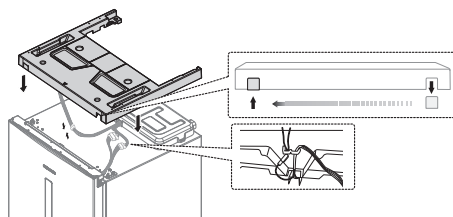

⚠ **WARNING** After reversing the doors, make sure the Freezer door gaskets are properly arranged. If not, there might be a noise or dew formed which affects performance of the refrigerator.

LEVELLING THE FREEZER

If the front of the appliance is slightly higher than the rear, the door can be opened and closed more easily.

Turn the adjusting legs clockwise to raise and counter-clockwise to lower the height.

Case 1) The appliance tilts down to the left.

- Turn the left adjusting leg in the direction of the arrow until the appliance is level.

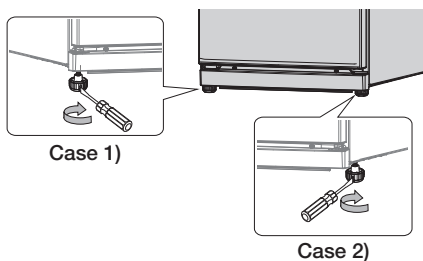



Case 2) The appliance tilts down to the right.

- Turn the right adjusting leg in the direction of the arrow until the appliance is level.

Operating your freezer

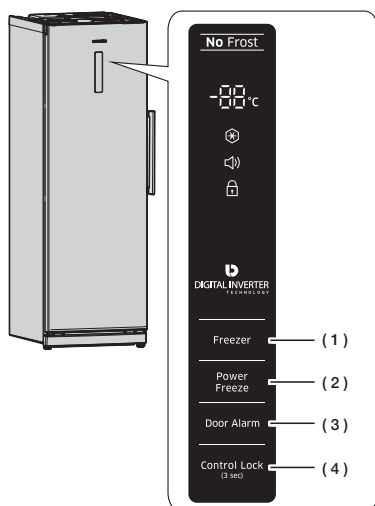
CHECKING THE CONTROL PANEL



 Each time you press the button, a short beep will sound.

USING THE CONTROL PANEL

(1) Freezer

Press the Freezer button to set the desired temperature from the range between -15 °C and -23 °C.

Default set temperature is set on -19 °C and each time you press the Freezer button temperature will change in following order and temperature indicator will display the desired temperature.

-00 °C

-19 °C - -20 °C - -21 °C - -22 °C - -23 °C
-18 °C - -17 °C - -16 °C - -15 °C

When the temperature setting is done, temperature indicator will display the current temperature of the freezer.

(2) Power Freeze

Press the Power Freeze button to activate the Power Freeze function. Power Freeze indicator will light up and the freezer will speed up the time to needed to freeze products in the freezer.



When you use this function, the energy consumption will increase. This function must be activated before putting large amount of food stuff in the freezer compartment at least 20 hours before. To deactivate the Power Freeze function, press the Power Freeze button again.

(3) Door Alarm

1. Door Alarm

Press the Door Alarm button to activate the Alarm function.

Alarm indicator will light up and the refrigerator will alert you with alarm sound if the freezer door is kept open for longer than 2 minutes. To deactivate the Alarm function, press the Door Alarm button again.

2. Temperature Alarm

Press the Door Alarm button to activate the temperature alarm function. The alarm indicator will light up. If the freezer compartment is too warm because there has been a power failure, the signal of "--" flashes on the display.



When the Freezer button is pressed, the "warmest temperature" which has reached in the freezer compartment is flashed on the display for five seconds. Then the actual temperature is indicated.

To deactivate the Temperature Alarm function, press the Door Alarm button again.

This warning may operate;

- when the appliance is turned on
- the freezer compartment is too warm due to a power failure

3. Display Off

As standard, the temperature display is switched off, to switch between on and off mode, press Door Alarm button for 3 seconds.

(4) Control Lock (3 sec)



Press the Control Lock button for 3 seconds to activate the Lock function. Lock indicator will light up and all the buttons on the control panel will be locked. To deactivate the Lock function, press the Control Lock button again for 3 seconds.



Some of the features can be different and may not be available depending on the model.

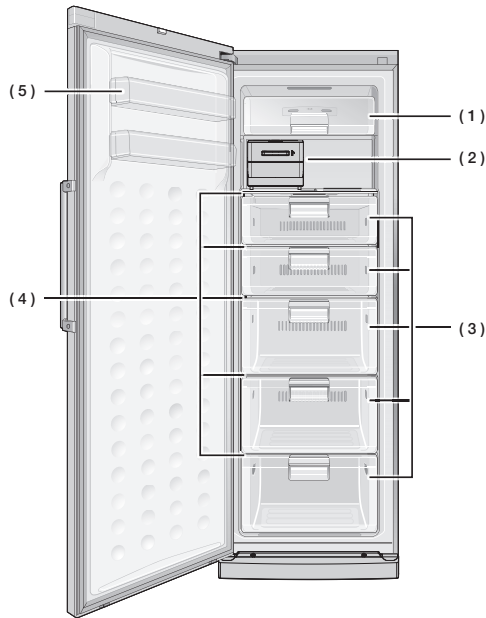

(1) TOP SHELF

Top shelf was equipped with flip type plastic cover to easily get or store foods.

(2) TWIST ICE MAKER (OPTIONAL)

You can make ice and store them in the ice bin underneath the twist ice maker.

(3) BIG BOX

Best used to store meats or dry foods.
Stored food should be wrapped securely with foil or other suitable wrapping material or containers.

(4) TEMPERED GLASS SHELF

Holds the big boxes but it can be used as ordinary shelves to put the foods on it.

(5) SOFT FROST DOOR GUARD

Can be used for small packages of frozen food.

- Position of the Twist ice maker (2) can be switched with each other.
- To get more space, you can remove cover of Top shelf (1), Twist ice maker (2), and top four of the Big boxes (3). It does not affect thermal and mechanical characteristics. A declared storage volume of freezer compartment is calculated with these parts removed.



Do not store glass bottles in the freezer.

MAKING ICE

 Ice tray may look different depending on models.

Making ice cubes

1. Remove the ice cube tray by pulling it towards you.
2. Fill the tray with water up to the maximum water level marked on the tray.
3. Slide the tray back into the holder, taking care not to spill the water.
4. Wait until the ice cubes are formed.

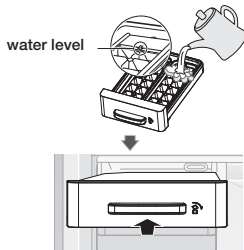

Freezing time

It is recommended that you wait for about one hour with the temperature set to Power Freeze for the ice cubes to form.

Removing the ice cubes

1. Make sure that the ice bin is in place under the ice tray. If not, slide it into place.
2. Twist the handle of ice tray firmly in the clockwise direction until the tray twists slightly. The ice cubes fall into the storage bin.
3. To get ice, slightly lift up the ice tray and pull it towards you.

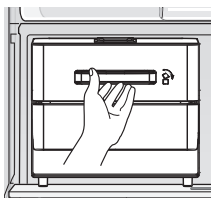



REMOVING THE INTERIOR PARTS

 Some of the features can be different and may not be available depending on the model.

Top shelf cover

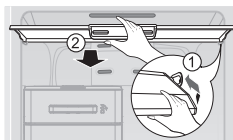
1. Push the right side of cover inward until you can get the projection on the left side out.
2. When both sides of the projections are out of the grooves, pull it towards you to remove the cover.



 Make sure that you remove the top shelf cover when you assemble or disassemble the glass shelf.

Twist ice maker (Optional)

Slightly lift up the twist ice maker and pull it towards you.

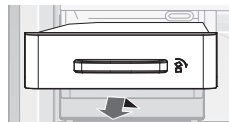

Boxes

Pull the boxes out fully then slightly lift it up to remove the boxes. (Small box/Fresher box/Big box)

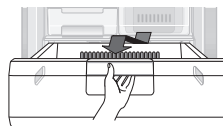

Tempered glass shelf

Gently lift up the shelves with both hands and pull it toward you.

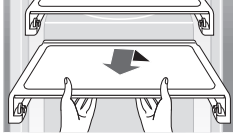

Soft frost door guard

Firmly grab the door guard with both hands and lift it up gently to remove the door guard.

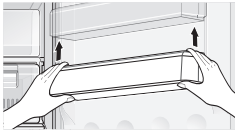

CLEANING THE FREEZER



Do not use Benzene, Thinner or Clorox™ for cleaning.

They may damage the surface of the appliance and can create a risk of fire.



Do not spray the freezer with water while it is plugged in, as it may cause an electric shock.

Do not clean the freezer with benzene, thinner or car detergent for risk of fire.

MAINTAINING THE INTERIOR PARTS

Maintaining the Interior Light



Please contact your service agents.

Troubleshooting

PROBLEM	SOLUTION
The appliance is not operating at all or the temperature is too high.	<ul style="list-style-type: none"> • Check if the power plug is correctly connected. • Is the temperature control on the front panel correctly set? • Does sun shine on the appliance or are there any heat sources nearby? • Is the back of the appliance too close to the wall?
There are unusual noises.	<ul style="list-style-type: none"> • Check if the appliance is installed on a stable and even floor. • Is the back of the appliance too close to the wall? • Have any foreign objects fallen behind or under the appliance? • Is the noise coming from the compressor in the appliance? • A ticking sound may be heard inside the appliance; this is normal. This sound occurs when the various accessories contract or expand.
The front corners and sides of the appliance are warm and condensation starts to form.	<ul style="list-style-type: none"> • Heat-proof pipes are installed in the front corners of the appliance to prevent condensation from forming. When the surrounding temperature rises, this may not always be effective. However, this is not abnormal. • In very humid weather, condensation may form on the outer surface of the appliance when the moisture in the air comes into contact with the cool surface of the appliance.
You can hear a liquid bubbling in the appliance.	<ul style="list-style-type: none"> • This is the refrigerant, which cools the inside of the appliance.
There is a bad smell inside the appliance.	<ul style="list-style-type: none"> • Is there any spoiled food inside of the freezer? • Make sure that strong smelling food (for example, fish) is wrapped so that it is airtight. • Clean out your freezer periodically and throw away any spoiled or suspect food.
There is a layer of frost on the appliances walls.	<ul style="list-style-type: none"> • Are the air outlet vents blocked by food stored inside the freezer? • Space the food out as much as possible to improve ventilation. • Is the door fully closed?
Condensation forms on the inside wall of the appliance.	<ul style="list-style-type: none"> • Food with a high water content is stored uncovered with a high humidity level or the door has been left open for a long time. • Store the food with a cover or in sealed containers.

Circuit diagram

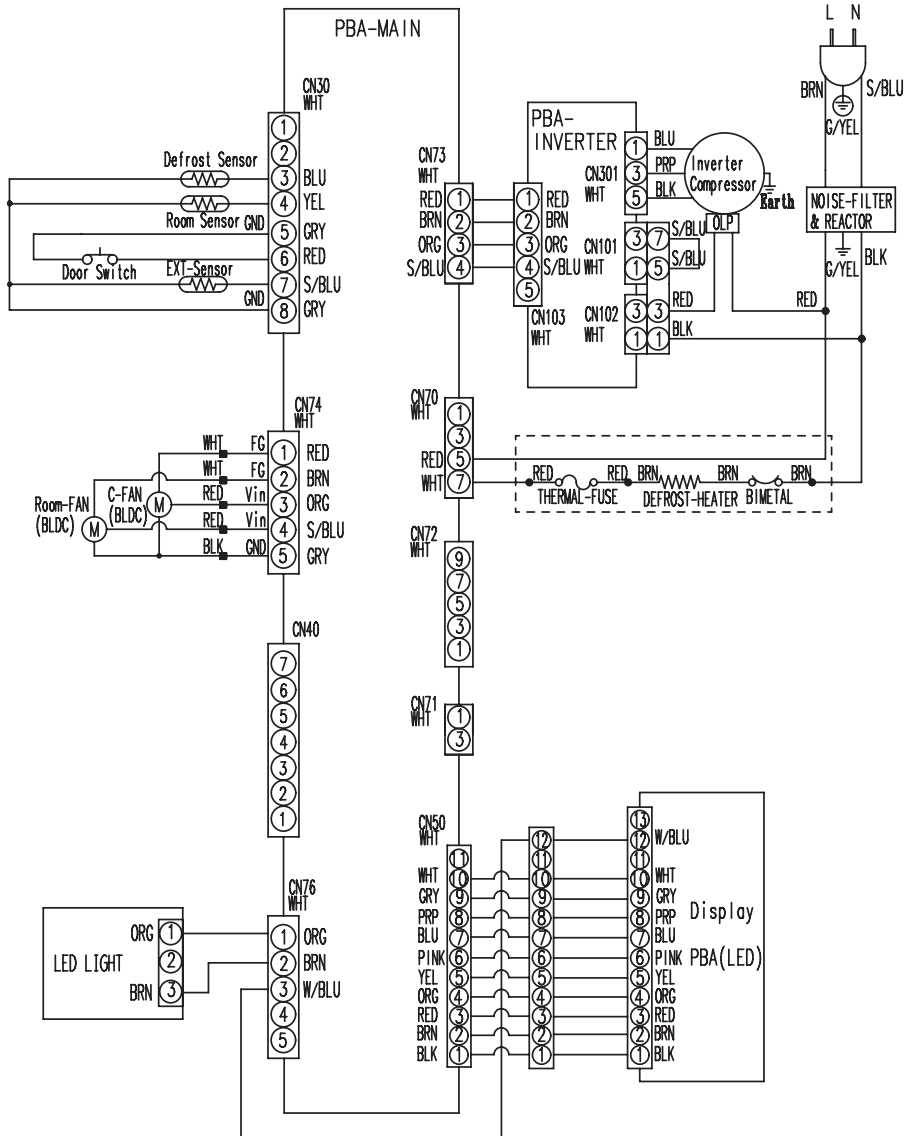

Ambient Room Temperature Limits

This refrigerator is designed to operate in ambient temperatures specified by its temperature class marked on the rating plate.

Class	Symbol	Ambient Temperature range (°C)	
		IEC 62552 (ISO 15502)	ISO 8561
Extended Temperate	SN	+10 to +32	+10 to +32
Temperate	N	+16 to +32	+16 to +32
Subtropical	ST	+16 to +38	+18 to +38
Tropical	T	+16 to +43	+18 to +43



Internal temperatures may be affected by such factors as the location of the refrigerator, ambient temperature and the frequency with which you open the door. Adjust the temperature as required to compensate for these factors.

English

Correct Disposal of This Product (Waste Electrical & Electronic Equipment)

(Applicable in countries with separate collection systems)

This marking on the product, accessories or literature indicates that the product and its electronic accessories (e.g. charger, headset, USB cable) should not be disposed of with other household waste at the end of their working life. To prevent possible harm to the environment or human health from uncontrolled waste disposal, please separate these items from other types of waste and recycle them responsibly to promote the sustainable reuse of material resources.

Household users should contact either the retailer where they purchased this product, or their local government office, for details of where and how they can take these items for environmentally safe recycling.

Business users should contact their supplier and check the terms and conditions of the purchase contract. This product and its electronic accessories should not be mixed with other commercial wastes for disposal.

Contact SAMSUNG WORLD WIDE

If you have any questions or comments relating to Samsung products, please contact the SAMSUNG customer care center.

COUNTRY	CALL	Web site
AUSTRIA	0800-SAMSUNG (0800-7267864) [Only for Premium HA] 0800-366661 [Only for Dealers] 0810-112233	www.samsung.com/at/support
COLOMBIA	Bogotá 600 12 72 Gratis desde cualquier parte del país 01 8000 112 112 ó desde su celular #SAM(726)	www.samsung.com/co/support
EIRE	0818 717100	www.samsung.com/ie/support
HONG KONG	(852) 3698-4698	www.samsung.com/hk/support (Chinese) www.samsung.com/hk_en/support (English)
INDIA	1800 3000 8282 - Toll Free 1800 266 8282 - Toll Free	www.samsung.com/in/support
MALAYSIA	1800-88-9999 603-77137477 (Overseas contact)	www.samsung.com/my/support
NEW ZEALAND	0800 726 786	www.samsung.com/nz/support
PANAMA	800-7267 800-0101	www.samsung.com/latin/support (Spanish) www.samsung.com/latin_en/support (English)
PHILIPPINES	1-800-10-7267864 [PLDT] 1-800-8-7267864 [Globe landline and Mobile] 02-4222111 [Other landline]	www.samsung.com/ph/support
SINGAPORE	1800-SAMSUNG(726-7864)	www.samsung.com/sg/support
SOUTH AFRICA	0860 SAMSUNG (726 7864)	www.samsung.com/support
UK	0330 SAMSUNG (7267864)	www.samsung.com/uk/support



DA68-03009C-05