

Boston Basic Modular 4 Boxes

Assembly Instructions - Please keep for future reference

609/0052

609/2593

610/8920

404/4505

402/0804

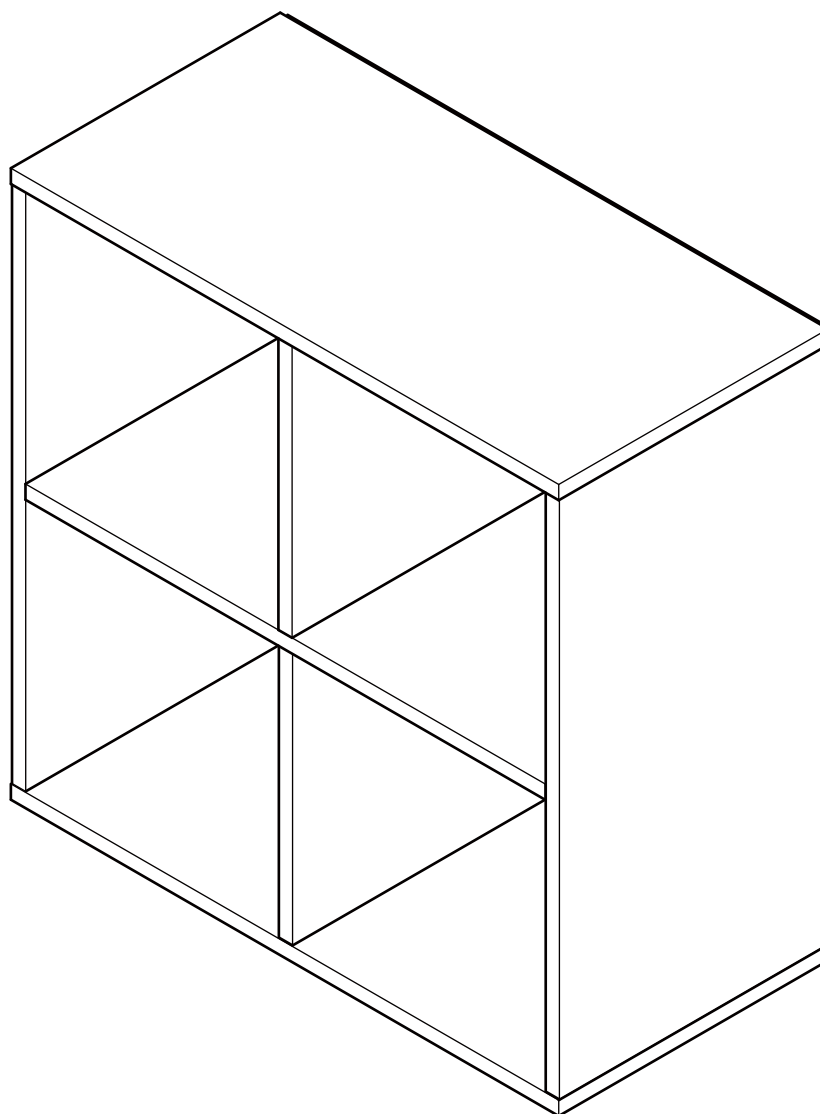

Dimensions

Width - 60cm

Depth - 30cm

Height - 60cm

Important - Please read these instructions fully before starting assembly

If you need help or have damaged or missing parts, call the **Customer Helpline:**
Argos = 0345 6400800



Safety and Care Advice

Important – Please read these instructions fully before starting assembly

- Check you have all the components and tools listed on the following pages.
- Remove all fittings from the plastic bags and separate them into their groups.
- Keep children and animals away from the work area, small parts could choke if swallowed.
- Make sure you have enough space to layout the parts before starting.

- During assembly do not stand or put weight on the product, this could cause damage.
- Assemble the item as close to its final position (in the same room) as possible.
- Assemble on a soft level surface to avoid damaging the unit or your floor.
- Parts of the assembly will be easier with 2 people.



- To reduce the likelihood of damaging your product please ensure that your power drill is set on a low torque setting.

Care and maintenance

- Only clean using a damp cloth and mild detergent, do not use bleach or abrasive cleaners.
- From time to time check that there are no loose screws on this unit.
- This product should not be discarded with household waste. Take to your local authority waste disposal centre.

Handy Hints

- Assemble all parts and bolts loosely during assembly, only once the product is complete should you fully tighten the bolts
- Regularly check and ensure that all bolts and fittings are tightened properly.

Components - Panels

If you have damaged or missing components, call the
Customer Helpline: Argos = 0345 6400800

Please check you have all the panels listed below

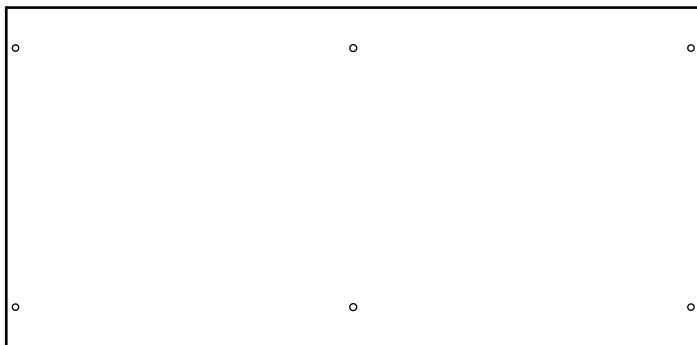

1 Top/Bottom panel x 2 (60 x 29.5cm)

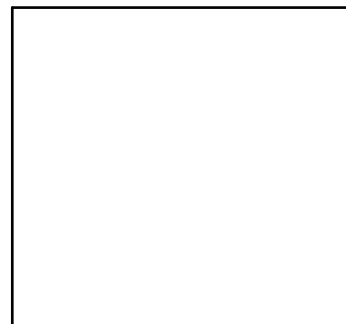

4 Vertical support x 2
(29.4 x 27.65cm)



2 Side panel x 2 (56.9 x 29.4cm)



5 Back panel x 2
(29.5 x 59.6cm)

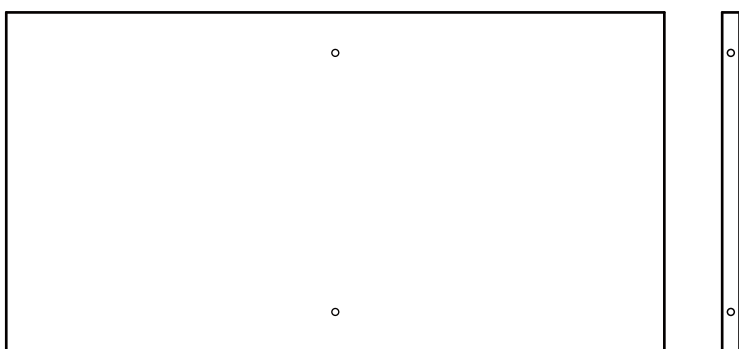





3 Middle shelf (56.9 x 29.4cm)

Components - Fittings

Please check you have all the fittings listed below

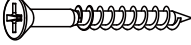
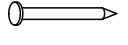
Note: The quantities below are the correct amount to complete the assembly. in some cases more fittings may be supplied than are required.

<p>A </p> <p>50mm Dowel x 2</p>	<p>B </p> <p>30mm Dowel x 8</p>	<p>C </p> <p>40mm Screw x 8</p>
<p>D </p> <p>Nail x 20</p>	<p>E </p> <p>Screw cover x 4</p>	

Tools required

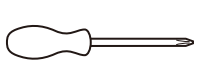

Phillips screwdriver
(medium & large)

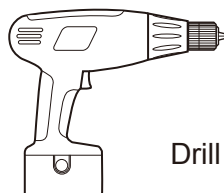

Drill



Small
hammer



7mm Suitable drill bit
(for use with wall plug)



Ruler/tape
measure



Eye protection
(when using a
hammer or glue)

Ruler - Use this ruler to help correctly identify the screws

0 5 10 15 20 25 30 35 40 45 50 55 60 65 70 75 80 85 90 95 100 105 110 115 120 125 130 135 140 145 150 155 160 165 170



The screws length is measured from the head to the point (30mm screw shown).

Assembly Instructions

Step 1

Attaching the middle shelf

Use Dowels **A** to fix the Vertical supports **4** onto the Middle shelf **3**.

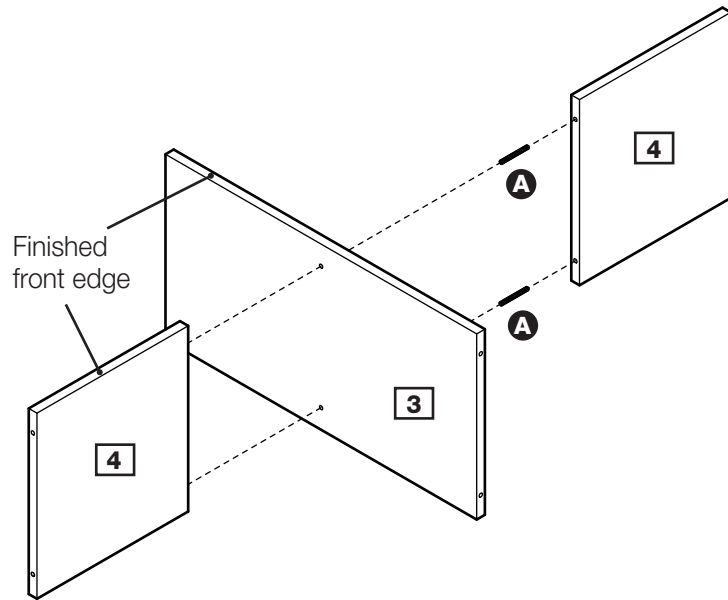

Step 2

Attaching the side panels

Use Dowels **B** to fix the Side panels **2** onto the Middle shelf **3**.

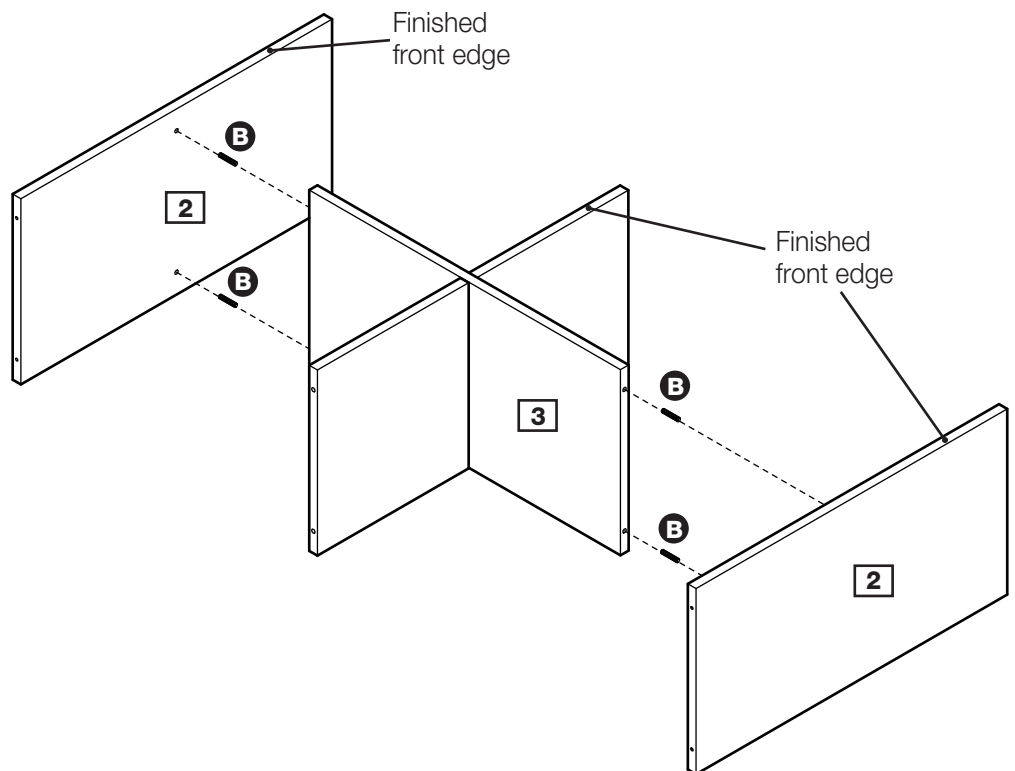

Assembly Instructions

Step 3

Attaching the top/bottom panels

a: Use Screws **C** and Dowels **B** to fix the Bottom panel **1** onto the unit.

a:

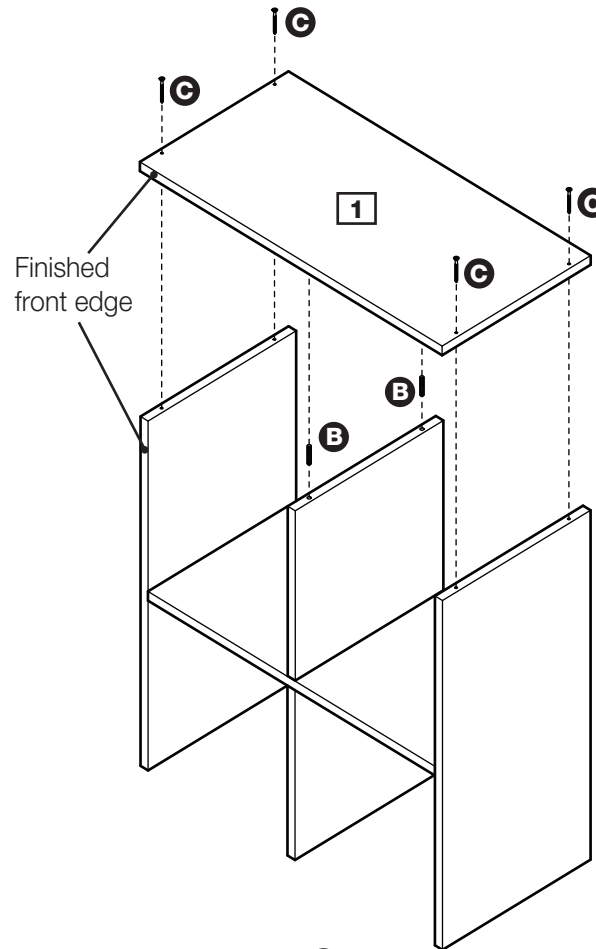

b: Use Screws **C** and Dowels **B** to fix the Top panel **1** onto the unit.

b:

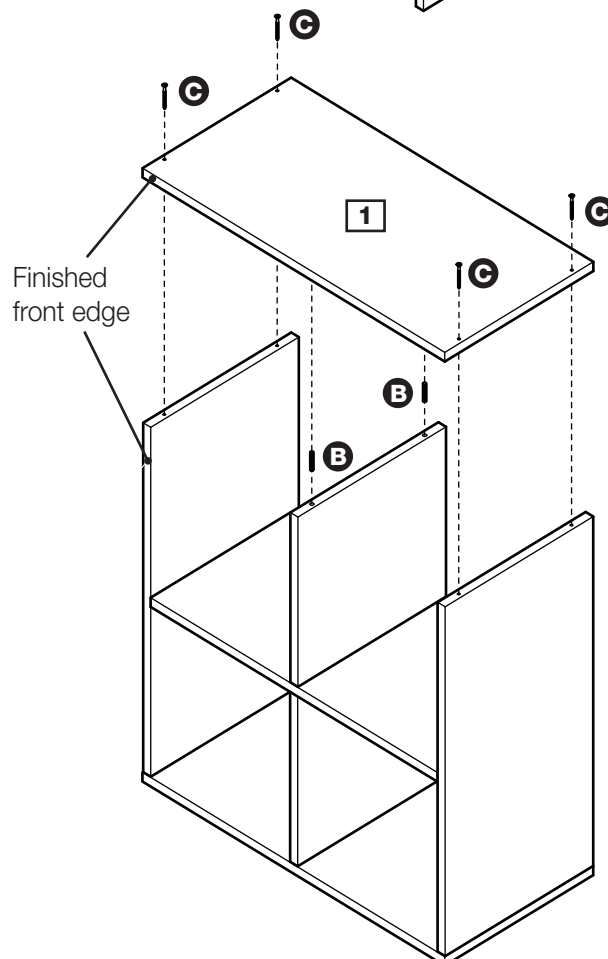

Assembly Instructions

Step 4

Fixing back panel

a: Attach Back panels **5** onto the unit using Nails **D**.



Important:

The unit **MUST** be 'square' when back is attached.

a:

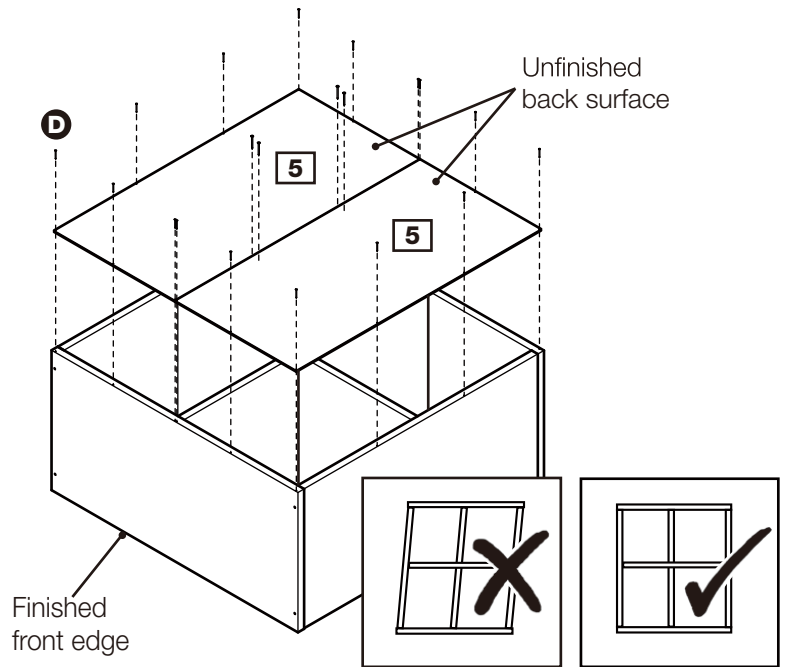

b: Use Screw covers **E** to cover the screw heads.

b:

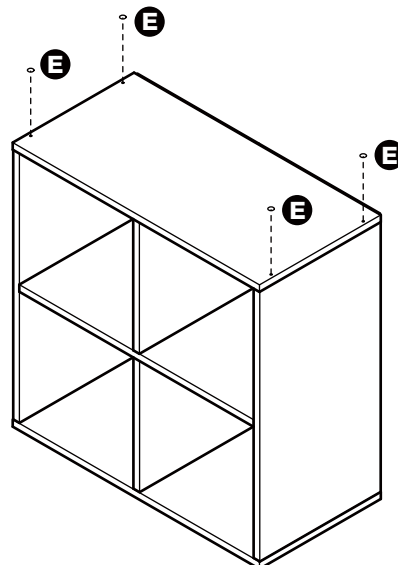

Step 5

Finished the unit

Note: It would be useful to ask someone to help you at the stage.

With help, place the unit in the intended position.

Assembly is complete.

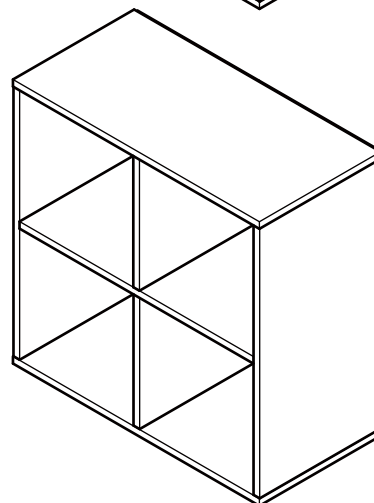

If you need help or have damaged or missing parts, call the **Customer Helpline:**
Argos = 0345 6400800