

FP48992 MUK Rev 3

morphyrichards[®]
smart ideas for your home



Accents Folding Stand Mixer

 Please read and keep these instructions for future use

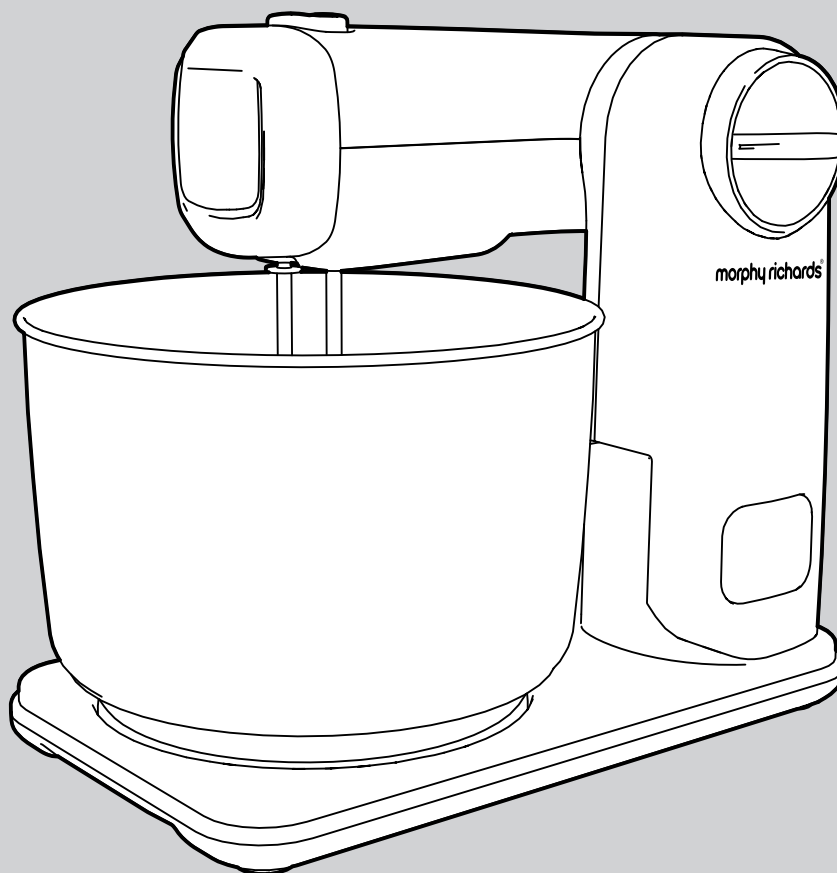

For competitions, product hints and tips
and more join us at



www.morphyrichards.co.uk/blog



www.facebook.com/loveyourhome



[@loveyourmorphyrichards](https://twitter.com/loveyourmorphyrichards)

www.morphyrichards.com

* Register online for your 2 year guarantee. See the back of this instruction book for details, (UK and Ireland customers only).

Health and Safety

The use of any electrical appliance requires the following common sense safety rules. Please read these instructions carefully before using the product.

- This appliance can be used by persons with reduced physical, sensory or mental capabilities, or lack of experience and knowledge, if they have been given supervision or instruction concerning the use of the appliance in a safe way and understand the hazards involved.
- Children shall not play with the appliance.
- The appliance shall not be used by children.
- Keep the appliance and its cord out of reach of children.
- Ensure the attachments have stopped rotating before lifting the mixer head upwards.

Location

- This appliance is intended to be used in household and similar applications such as:
farm houses;
by clients in hotels, motels and other residential type environments;
bed and breakfast type environments.
It is not suitable for use in staff kitchen areas in shops, offices and other working environments.
- Always locate your appliance away from the edge of the worktop.
- Do not place the bowl used with the appliance on a highly polished wooden surface as damage may occur to the surface.
- Do not place the appliance on or near a hot surface, such as a hot plate or radiant rings or near a naked flame.

Mains cable

- Do not let the mains cable hang over the edge of the worktop where a child could reach it.
- Do not let the lead run across an open space e.g. between a low socket and a table.
- Do not let the cable run across a cooker or other hot area which might damage the cable.
- The mains cable should reach from the socket to the base unit without straining the connections.
- The power cord cannot be replaced. Contact the service centre for advice.

Personal safety

- Avoid touching moving parts. Keep hands, hair, clothing and utensils away from the rotating parts during operation to prevent personal injury and/or damage to the appliance.
- **WARNING:** To protect against the risk of electric shock, NEVER immerse the appliance body in water or in any other liquid and always ensure the electrical connections are kept dry.

Other safety considerations

- Do not operate any appliance with a damaged cord or plug or after the appliance malfunctions or has been damaged in any manner.
- The use of attachments or tools not recommended or sold by Morphy Richards may cause fire, electric shock or injury.
- Do not use the appliance for anything other than its intended purpose.
- Unplug from the outlet when not in use, or when left unattended, and before assembling, disassembling or cleaning.
- Caution: In order to avoid a hazard due to the inadvertent resetting of the thermal cut out, this appliance must not be supplied through an external switching device, such as a timer or connected to a circuit that is regularly switched on and off by the utility.
- Do not mix for longer than the time periods recommended in 'Usage' on page 5.

Electrical requirements

Check that the voltage on the rating plate of your appliance corresponds with your house electricity supply which must be A.C. (Alternating Current).
Should the fuse in the mains plug require changing, a 3 amp BS1362 fuse must be fitted.

Product overview

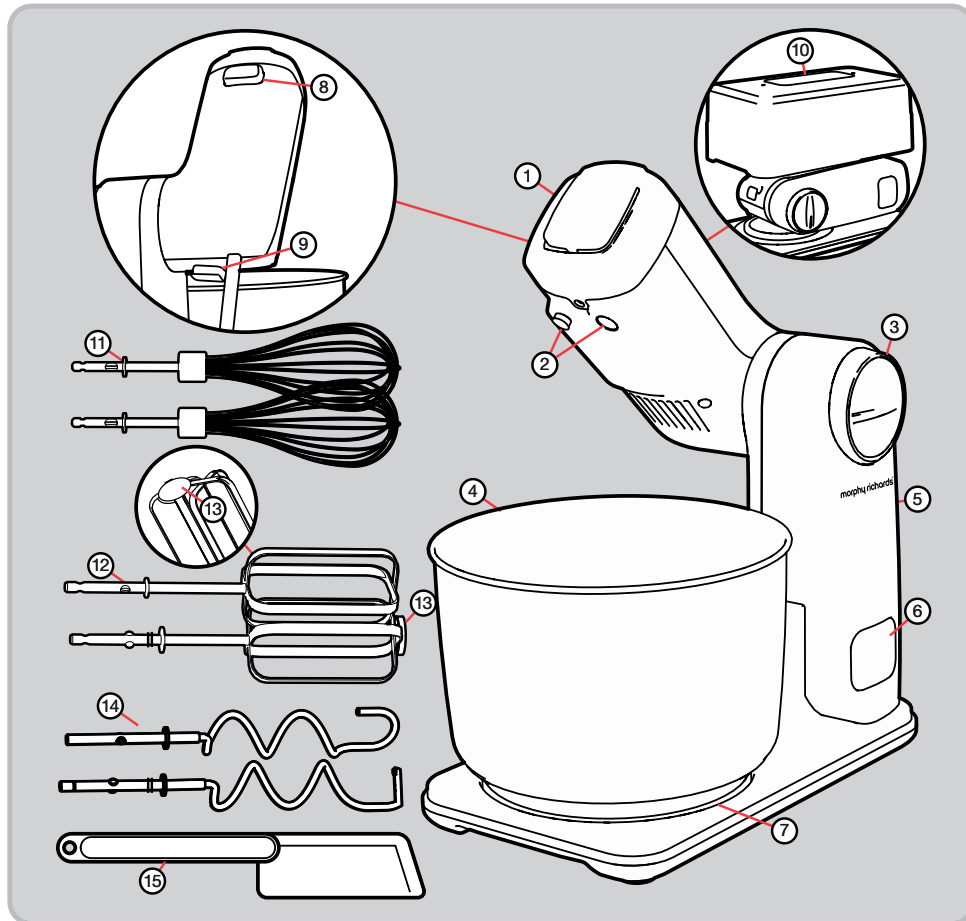

Features

- | | |
|-------------------------------|------------------------------|
| (1) Head Unit | (9) Head Unit Release Button |
| (2) Sockets | (10) Storage Lid |
| (3) Speed Control | (11) Whisks |
| (4) Mixing Bowl | (12) Beaters |
| (5) Base Unit Arm | (13) Drive Plate |
| (6) Folding Button | (14) Dough Hooks |
| (7) Rotating Base | (15) Spatula |
| (8) Attachment Release Button | |

Before first use

Before using your Accents Folding Stand Mixer for the first time, wash the Mixing Bowl (4), attachments (11),(12),(14) and Spatula (15) in warm soapy water. Dry thoroughly before use.

Using your Stand Mixer

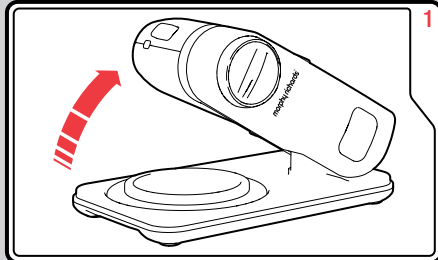

Remove the Storage Lid (10). Lift the Base Unit Arm (5) into the upright position. It will lock into place.

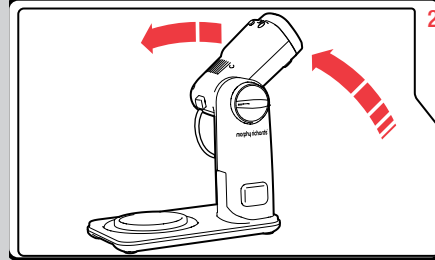

Rotate the Head Unit (1) into place. It will lock into the upright position.

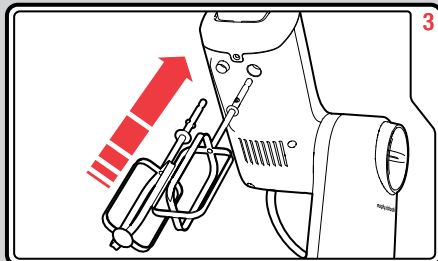

Insert the required attachment (11),(12) or (14), into the Sockets (2), ensure they are inserted in the correct Sockets, (please see page 6 for more information).

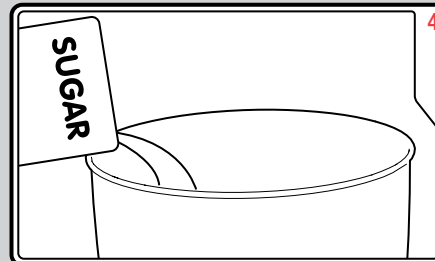

Add your ingredients to the Mixing Bowl (4). Place the Mixing Bowl onto the Rotating Base (7).

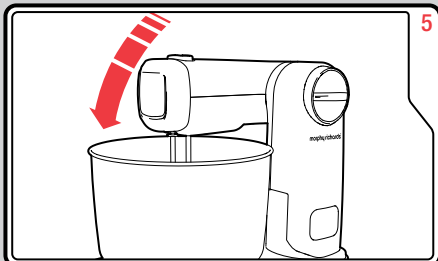

Press the Head Unit Release Button (9) to lower the attachments into the Mixing Bowl. The Head Unit will lock into place.

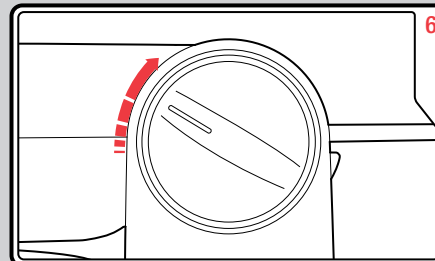

Plug the Stand Mixer into the mains. Turn the Speed Control (3) to position 1 to start the Stand Mixer, increase the speed as required.

Using your Stand Mixer

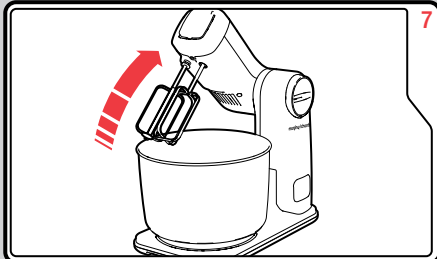

When your mixing is complete, turn the mixer off. Press the Head Unit Release Button (9) and lift the Head Unit. The Head Unit will lock in the upright position.

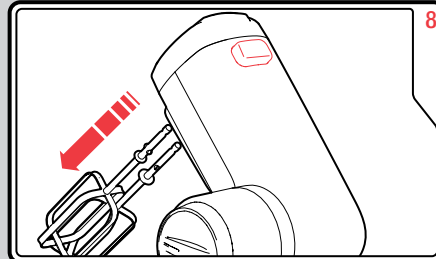

Press the Attachment Release Button (8) to remove the attachments from the Stand Mixer. Clean and fold for Storage.

Important

- Your Folding Stand Mixer has a unique Mixing Bowl (4) rotating system which allows the user to fully control the mixing process.

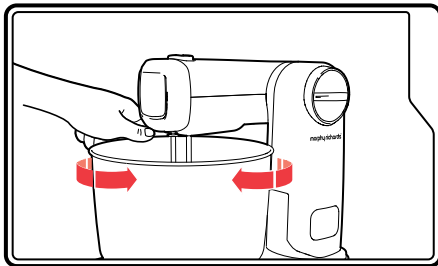

- The Mixing Bowl is self rotating for ease of mixing light ingredients. During the mixing process however, it will be necessary to control the speed of the Mixing Bowl; rotate manually by using your hand on the side of the bowl to either slow it down or to turn it clockwise & anticlockwise to aid mixing.
- You can also rotate the bowl in the opposite direction (anticlockwise), ingredients will be incorporated further for a more effective mix for some recipes. See individual recipes where this is advised.
- During mixing, ingredients may splash or cling to the side of the Mixing Bowl, turn the Speed Control (3) to the 'Off' position, using the Spatula (15) scrape the side of the Mixing Bowl incorporating this into the centre of the Mixing Bowl, continue mixing.

- When individual ingredients are added it may be necessary to scrape the side of the bowl further, always turn the Mixer off first.

Usage

Your mixer features a safety cut out designed to protect the motor from overheating. After 6 minutes of continuous use to prevent overheating you will need to switch off your stand mixer and leave to cool for 10 minutes, especially important when mixing heavier mixtures. If your machine cuts out during mixing turn the Speed Control (3) to the 'Off' position and leave to cool for 10 minutes.

Capacity

Do not overfill the Mixing Bowl (4) as damage to the mixer could occur. Maximum quantity - 1Kg of combined dry & wet ingredients should be sufficient for most mixing operations with the Beaters (12).

For preparing dough with the Dough Hooks (14) do not use more than 350g of flour.

If at any point you hear the mixer labouing, increase the speed. If required remove some of the mixture if it is overloaded or the mixture is too thick.

Attachments

Your Stand Mixer comes with three mixing attachments, each is designed for a specific task.

Whisks (11)

Use the Whisk attachments for whisking eggs and cream. Don't use the whisk for heavy mixtures (like fruit cake or cookie dough).

Beaters (12)

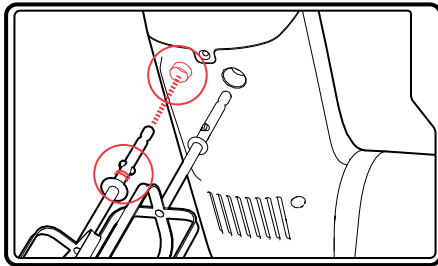

Use the Beaters for mixing cake mixes, cookie dough and creamed potatoes.

One of the Beaters is fitted with a Drive Plate (13) which helps the bowl rotate during use. This Beater also has a red band on the shaft. Ensure this Beater is fitted to the raised Socket (2) with the RED interior. Otherwise your stand mixer may not work correctly.

Note: Depending on the ingredients being mixed, the bowl may require some assistance to rotate. Manually turn the bowl to help incorporate the ingredients.

Dough Hook (14)

Use the Dough Hooks for pastry mixtures.

Dough Hooks need to be fitted correctly or they will not knead the dough. Ensure the Dough Hook with the flat end and the red band on the shaft is fitted to the raised Socket (2) with the RED interior.

The Dough Hooks are designed so they cannot be fitted incorrectly.

Not suitable for heavy dough.

Recipes

Chocolate chip cookies

Serves 18

Ingredients:

- 250g plain flour
- ½tsp bicarbonate of soda
- ½tsp salt
- 170g unsalted butter, melted
- 200g dark brown soft sugar
- 100g caster sugar
- 1tbsp vanilla extract
- 1 egg
- 1 egg yolk
- 325g chocolate chips

Method:

- 1 Preheat the oven to 170°C / Gas mark 3. Grease baking trays or line with parchment.
- 2 Sift together the flour, bicarbonate of soda and salt; set aside.
- 3 Attach the Beater Attachments to the Mixer. In the Mixing Bowl, add the melted butter, brown sugar and caster sugar and beat until well blended. Start on speed 1, increasing to speed 3 if required. Part way through mixing, it may be necessary to stop the Mixer and scrape the sides of the bowl down using the Spatula.
- 4 Beat in the vanilla, egg and egg yolk until light and creamy using speeds 1-3.
- 5 Using speed 1, mix in the sifted ingredients until just blended. Part way through mixing, it may be necessary to stop the Mixer and scrape the sides of the bowl down using the Spatula.
- 6 Stir in the chocolate chips by hand using a wooden spoon. Drop cookie dough onto the prepared baking trays, for each cookie use around 4 tablespoons of dough (for smaller cookies, drop 1 rounded tablespoonful and adjust baking time as necessary). Do not flatten the dough. Cookies should be about 8cm apart.
- 7 Bake for 15 to 17 minutes in the preheated oven, or until the edges are lightly toasted. Allow to cool on the baking trays for a few minutes before transferring to wire racks to cool completely.

Lemon meringue pie

For the pastry:

- 460g plain flour
- 280g good quality unsalted butter at room temperature (cut into pieces)
- 120g unrefined caster sugar
- 2 eggs
- Pinch of salt

For the filling:

- 2x397g tins condensed milk
- 250ml lemon juice
- 2tsp grated lemon zest
- 6 egg yolks

For the meringue topping:

- 6 egg whites
- ½tsp cream of tartar
- 125g sugar

Method:

- 1 Place the softened butter, salt and sugar in the Mixing Bowl, attach the Beater Attachments and cream the sugar and butter until fluffy and pale in colour. Start on speed 1, increasing to speed 3. Part way through mixing, it may be necessary to stop the Mixer and scrape the sides of the bowl down using the Spatula.
- 2 Crack the eggs into a small bowl and lightly whisk. Slowly add the eggs a bit at a time to the butter mixture, mixing well. Use speed 1-3. Add a little of the flour with the eggs to prevent the mixture from curdling. Part way through mixing, it may be necessary to stop the Mixer and scrape the sides of the bowl down using the Spatula.
- 3 Remove the Mixing Bowl and Beaters and sieve the flour over the creamed butter, return to the Mixer, attach the Dough Hooks. Using speeds 1-3 slowly mix in the flour into the batter, do not over mix. Once the pastry comes together stop mixing.
- 4 Turn the pastry out on to a lightly floured work surface, divide the pastry in half, do not knead the pastry, just push it together. Cover each piece with cling film and make it airtight. Place in the fridge for 30 minutes or until firm.
- 5 Preheat the oven to 190°C / Gas mark 5. Grease a 25cm fluted loose bottom tin. Place the tin onto a baking tray.
- 6 Roll out the pastry until it's big enough to generously fit the tin, leaving excess pastry falling over the sides of the tin onto the baking tray underneath the tin - don't trim at this stage.
- 7 Line the pastry with greaseproof paper and fill with baking beans. Trim the excess pastry using a sharp knife. Bake the pastry case blind for about 15-20 minutes or until the pastry is pale golden and dried out - remove the paper and beans for the last five minutes.
- 8 Lower the oven heat to 150°C / Gas mark 2.
- 9 In the Mixing Bowl, add all the filling ingredients and attach the beater attachments. Using speed 1 beat until smooth.
- 10 Pour into cooled crust and bake for 30 minutes. Leave to cool before adding the meringue topping.
- 11 Raise the oven heat to 180°C / Gas mark 4.
- 12 Place the egg whites and cream of tartar in the Mixing Bowl and insert the Whisk Attachments.
- 13 Whisk on maximum speed until at the soft peak stage. This takes about 3 minutes. During mixing hold the Mixing Bowl steady and turn clockwise and anticlockwise to allow the ingredients to mix thoroughly. It may be necessary to stop the unit and scrape the sides of the bowl a few times to make sure all the ingredients are incorporated.
- 14 Gradually beat in the sugar, over a period of 3 minutes, 1tsp at a time, until stiff.
- 15 Spread over the cooled filling; seal to edge of the pie crust. Bake for 15 minutes or until meringue is golden brown.
- 16 Leave to cool before serving.



Recipes

Fudge brownies

Ingredients:

Group1:

- 80g cocoa powder
- ½tsp bicarbonate of soda
- 80ml vegetable oil
- 120ml boiling water

Group2:

- 440g caster sugar
- 2 eggs
- 80ml vegetable oil
- 190g plain flour
- 1tsp vanilla essence
- ¼tsp salt

Method:

- 1 Pre heat the oven to 175°C / Gas Mark 3-4.
- 2 Attach the Beater Attachments to the Mixer. Grease and flour a 9x13 inch pan.
- 3 Mix the group 1 ingredients: Mix the cocoa with the bicarbonate of soda and add to the bowl along with the oil and water.
- 4 Mix on speed 1 until well blended and thickened.
- 5 Mix in the sugar, eggs and oil until thoroughly mixed.
- 6 During mixing hold the Mixing Bowl steady and turn clockwise and anticlockwise to allow the ingredients to mix thoroughly. It may be necessary to stop the mixer and scrape the sides of the bowl a few times to make sure all the ingredients are incorporated.
- 7 Add the flour, vanilla and salt and mix until just incorporated, do not over mix.
- 8 Spread evenly into the prepared pan and bake for 35-40 minutes or until a skewer comes out clean.
- 9 Allow to cool before cutting into squares.



Creamed potatoes

Ingredients:

- 725g potatoes, peeled and cut into chunks
- 100ml warm milk
- 1½tsp butter
- 1½tsp salt

Method:

- 1 Boil the potatoes for 30 minutes until soft.
- 2 Drain well and crush lightly with a fork to break up the potatoes.
- 3 Place in the Mixing Bowl and insert the Beater Attachments.
- 4 Beat on speed 3 for about 1 minute.
- 5 Add the other ingredients and beat for a further minute on speed 5-6 until creamy.
- 6 During mixing hold the Mixing Bowl steady and turn clockwise and anticlockwise to allow the ingredients to mix thoroughly. It may be necessary to stop the unit and scrape the sides of the bowl a few times to make sure all the ingredients are incorporated.





Victoria sandwich cake

Ingredients:

- 200g caster sugar
- 200g softened butter, cut into pieces
- 4 eggs, beaten
- 200g self-raising flour, sifted
- 1tsp baking powder
- 2tbsp milk

For the filling:

- 300ml whipping cream
- 1 jar of strawberry jam

Method:

- 1 Heat oven to 190°C / Gas Mark 5. Lightly grease two 20cm sandwich tins and line with non-stick baking paper.
- 2 Add all the ingredients to the Mixing Bowl and attach the Beater Attachments.
- 3 Beat all the cake ingredients together until you have a smooth, soft batter. Use speed 1 initially then increase to speed 3. Part way through mixing, it may be necessary to stop the Mixer and scrape the sides of the bowl down using the Spatula.
- 4 Divide the mixture between the tins, smooth the surface with the Spatula or the back of a spoon, then bake for about 20 minutes until golden and the cake springs back when pressed. Turn out onto a cooling rack and leave to cool completely.
- 5 Attach the Whisk Attachments to the Mixer and whip the cream for around 3 minutes starting at speed 1 and increasing to full speed.
- 6 Spread the jam over the bottom of one of the sponges, top with the cream and sandwich the second sponge on top. Dust with a little icing sugar before serving.

Buttercream

Ingredients:

- 75g butter
- 500g icing sugar
- pinch of salt
- 3-4tbsp milk
- 1½tsp vanilla

Method:

- 1 Place all ingredients in the Mixing Bowl.
- 2 Using the Beater Attachments, mix on speed 1 until light and creamy.
- 3 During mixing hold the bowl steady and turn anticlockwise to allow the ingredients to mix thoroughly. It may be necessary to stop the Mixer and scrape the sides of the Mixing Bowl using the Spatula a few times to make sure all the ingredients are incorporated.

Whipped cream

Ingredients:

- 200ml whipping cream*

*Min - 200ml

*Max - 600ml

Method:

- 1 Place cream in the Mixing Bowl and insert the Whisk Attachments.
- 2 Whip on speed 4-5 until desired thickness is achieved. (Guide time: 3-4 minutes). During mixing hold the Mixing Bowl steady and turn clockwise and anticlockwise to allow the ingredients to mix thoroughly. It may be necessary to stop the mixer and scrape the sides of the bowl a few times to make sure all the ingredients are incorporated.



Recipes

Meringues

Ingredients:

- 3 large egg whites*
 - 120g caster sugar
- *Min - 3 egg whites, use 40g of caster sugar per egg white.

Method:

- 1 Pre heat the oven to 150°C / Gas Mark 2.
- 2 Place the egg whites in the Mixing Bowl and insert Whisk Attachments.
- 3 Whisk on maximum speed until at the soft peak stage. This takes about 3 minutes. During mixing hold the Mixing Bowl steady and turn clockwise and anticlockwise to allow the ingredients to mix thoroughly. It may be necessary to stop the unit and scrape the sides of the bowl a few times to make sure all the ingredients are incorporated.
- 4 Gradually beat in the sugar, over a period of 3 minutes, 1tsp at a time, until stiff.
- 5 Shape spoonfuls of the mixture onto baking sheets lined with non stick baking paper and bake in the oven for 15 minutes.
- 6 Lower the temperature to 110°C / Gas Mark ¼ and cook for a further 2-3 hours until crisp and dry.

Storage

Your Folding Stand Mixer can be folded down after use for easy storage in a cupboard or other area. To fold your mixer, follow these steps.

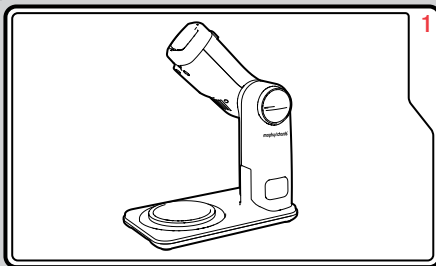

The Speed Control (3) must be set to '0' for the Base Unit Arm (5) to fold down. Ensure the Mixer is switched off with the attachments and Mixing Bowl (4) removed.

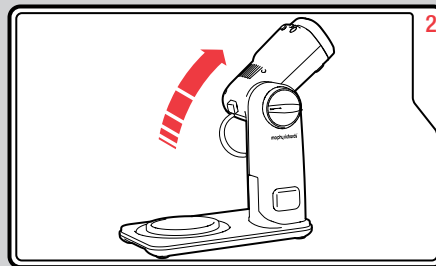

Press the Head Unit Release Button (9) and gently pull the Head Unit (1) back. The Head Unit will rotate back into the folded position.

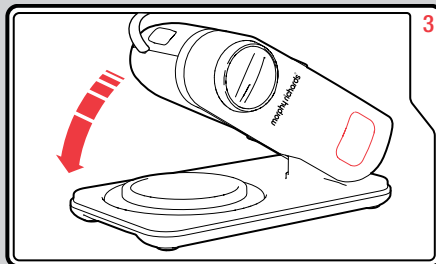

Press the Folding Button (6) on the Base Unit Arm (5), fold the mixer down onto the base. Placing a piece of packaging foam between the arms and base is recommended for protection.

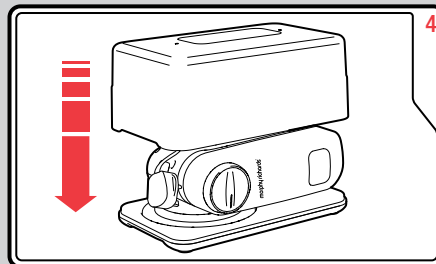

Curl the power cord up next to the mixer. Cover with the Storage Lid (10). Store the Mixing Bowl and attachments separately.



Care and cleaning

- Before cleaning, switch the Mixer off and unplug from the mains.
- Ensure the Mixer has cooled completely before using.
- To clean the Main Unit, use a damp cloth. Do not immerse in water. Do not use any abrasive or solvent-based cleaner.
- Wash the attachments (11),(12),(14), Spatula (15) and Mixing Bowl (4) in hot soapy water. Dry thoroughly.
- The Accessories and Mixing Bowl are dishwasher safe, place on the top shelf on a cool wash only.
- **WARNING: Never immerse the motor unit in water or other liquid.**

Contact us

Helpline

If you are having a problem with your appliance, please call our Helpline, as we are more likely to be able to help than the store you purchased the item from.

Please have the product name, model number and serial number to hand when you call to help us deal with your enquiry.

UK Helpline: 0844 871 0960

IRE Helpline: 1800 409 119

Spares: 0844 873 0726

Talk To Us

If you have any questions or comments, or want some great tips or recipe ideas to help you get the most out of your products, join us online:

Blog: www.morphyrichards.co.uk/blog

Facebook: www.facebook.com/morphyrichardsuk

Twitter: @loveyourmorphy

Website: www.morphyrichards.com

Notes



FP48992 MUK Rev3 3/14

Registering your 2 year guarantee

Your standard one year guarantee is extended for an additional 12 months when you register the product within 28 days of purchase with Morphy Richards. If you do not register the product with Morphy Richards within 28 days, your product is guaranteed for 1 year. To validate your 2 year guarantee register with us online at

www.morphyrichards.co.uk

Or call our customer registration line

UK 0844 871 0962

IRE 1800 409 119

N.B. Each qualifying product needs to be registered with Morphy Richards individually.

Please note that the 2 year guarantee is only available in the UK and Ireland. Please refer to the one year guarantee for more information.

Your 1 year guarantee

It is important to retain the retailer's receipt as proof of purchase. Staple your receipt to this back cover for future reference.

Please quote the following information if the product develops a fault. These numbers can be found on the base of the product.

Model no.

Serial no.

All Morphy Richards products are individually tested before leaving the factory. In the unlikely event of any appliance proving to be faulty within 28 days of purchase, it should be returned to the place of purchase for it to be replaced.

If the fault develops after 28 days and within 12 months of original purchase, you should contact the Helpline number quoting Model number and Serial number on the product, or write to Morphy Richards at the address shown.

You may be asked to return a copy of proof of purchase.

Subject to the exclusions set out below (see Exclusions), the faulty appliance will then be repaired or replaced as appropriate and dispatched usually within 7 working days of receipt.

If, for any reason, this item is replaced or repaired during the 1 year guarantee period, the guarantee on the new item will be calculated from original purchase date. Therefore it is vital to retain your original till receipt or invoice to indicate the date of initial purchase.

To qualify for the 1 year guarantee, the appliance must have been used according to the instructions supplied. For example, crumb trays should have been emptied regularly.

Exclusions

Morphy Richards shall not be liable to replace or repair the goods under the terms of the guarantee where:

- 1 The fault has been caused or is attributable to accidental use, misuse, negligent use or used contrary to the manufacturer's recommendations or where the fault has been caused by power surges or damage caused in transit.
 - 2 The appliance has been used on a voltage supply other than that stamped on the products.
 - 3 Repairs have been attempted by persons other than our service staff (or authorised dealer).
 - 4 The appliance has been used for hire purposes or non domestic use.
 - 5 The appliance is second hand.
 - 6 Morphy Richards reserves the right not to carry out any type of servicing under the guarantee at its discretion
 - 7 Plastic filters for all Morphy Richards kettles and coffee makers are not covered by the guarantee.
 - 8 Batteries and damage from leakage are not covered by the guarantee.
- This guarantee does not confer any rights other than those expressly set out above and does not cover any claims for consequential loss or damage. This guarantee is offered as an additional benefit and does not affect your statutory rights as a consumer. Morphy Richards products are intended for household use only. See usage limitations within the location safety instructions.

Disclaimer

Morphy Richards has a policy of continuous improvement in product quality and design. The company, therefore reserves the right to change the specification of its models at any time.



For electrical products sold within the European Community. At the end of the electrical products useful life, it should not be disposed of with household waste.

Please recycle where facilities exist. Check with your Local Authority or retailer for recycling advice in your country

**IF YOU ARE HAVING A PROBLEM
WITH ONE OF OUR PRODUCTS, CALL
OUR HELPLINE:**

**UK: 0844 871 0960
EIRE: 1800 409 119
SPARES: 0844 873 0726**

morphy richards

The After Sales Division
Morphy Richards Ltd
Mexborough, South Yorkshire,
England, S64 8AJ

Helplines (office hours)
UK 0844 871 0960
Spare Parts 0844 873 0726
Republic of Ireland 1800 409 119
www.morphyrichards.com

