

IMPORTANT

- **WARNING:** if the door or door seals are damaged, the oven must not be operated until it has been repaired by a competent person;
- **WARNING:** it is hazardous for anyone other than a competent person to carry out any service or repair operation that involves the removal of a cover which gives protection against exposure to microwave energy;
- **WARNING:** liquids and other food must not be heated in a sealed container since they are liable to explode;
- **WARNING:** only allow children to use the oven without supervision when adequate instruction have been given so that the child is able to use the oven in a safe way and understands the hazards of improper use.
- **WARNING:** accessible parts may become hot during use. Young children should be kept away.

CAREFULLY RETAIN THESE INSTRUCTIONS

Contents

Safety Information	2-6
Materials you can use in microwave oven	7
Materials to avoid using in the microwave oven	7
Utensils	7
Setting Up your Oven	8
Oven components and accessories	8
Turntable installation	8
Microwave cooking principle	9
Microwave Food Packaging Symbols	9
Accessories included	9
Installation	10-11
Please Note Electrical connection	10
Earthing installation	11
Operating your microwave oven	12-13
Cleaning your microwave oven	14
Troubleshooting and maintenance	15
Questions and Answers	16
Technical Specifications	17
Guarantee	18

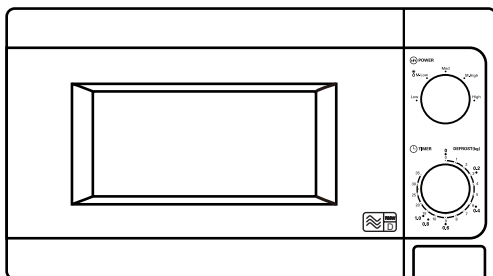

Safety Information

Important – Please read these instructions fully before installation

IMPORTANT SAFETY INSTRUCTIONS READ CAREFULLY AND KEEP FOR FUTURE REFERENCE

1. The temperature of accessible surfaces may get hot when the appliance is operating especially the metal top area and the warming rack if any.
2. This appliance is not intended for use by persons (including children) with reduced physical, sensory or mental capabilities, or lack of experience and knowledge, unless they have been given supervision or instruction concerning use of the appliance by a person responsible for their safety.
3. This appliance can be used by children aged from 8 years and above and persons with reduced physical, sensory or mental capabilities or lack of experience and knowledge if they have been given supervision or instruction concerning use of the appliance in a safe way and understand the hazards involved. Children shall not play with the appliance. Cleaning and user maintenance shall not be made by children unless they are older than 8 and supervised.
4. Keep the appliance and its cord out of reach of children less than 8 years.
5. Children should be supervised to ensure that they do not play with the appliance.

Safety Information

Important – Please read these instructions fully before installation

6. The appliance is not intended to be operated by means of an external timer or separate remote-control system.

7. The appliance is intended to be used in household and similar applications such as :

- staff kitchen areas in shops, offices and other working environment;
- by clients in hotels, motels and other residential type environments;
- farm houses;
- bed and breakfast type environments.

8. **WARNING** : If the door or door seals are damaged, the oven must not be operated until it has been repaired by a competent person.

9. **WARNING** : It is hazardous for anyone other than a competent person to carry out any service or repair operation that involves the removal of a cover which gives protection against exposure to microwave energy.

10. **WARNING** : Liquids and other foods must not be heated in sealed containers since they are liable to explode.

11. A minimum clearance of 12inches (30cm) must be left above the top of the oven.

Safety Information

Important – Please read these instructions fully before installation

12. Only use utensils that are suitable for use in microwave ovens.
13. When heating food in plastic or paper containers, keep an eye on the oven due to the possibility of ignition.
14. If smoke is emitted, switch off or unplug the appliance and keep the door closed in order to stifle and flames.
15. Microwave heating of beverages can result in delayed eruptive boiling, therefore care must be taken when handling the container.
16. The contents of feeding bottles and baby food jars shall be stirred or shaken and the temperature checked before consumption, in order to avoid burns.
17. Eggs in their shell and whole hard-boiled eggs should not be heated in microwave ovens since they may explode, even after microwave heating has ended.
18. The oven should be cleaned regularly and any food deposits removed.
19. When cleaning door and oven surfaces use only mild, non-abrasive soaps or detergents applied with a sponge or soft cloth.

Safety Information

Important – Please read these instructions fully before installation

20. Failure to maintain the oven in a clean condition could lead to deterioration of the surface which could adversely affect the life of the appliance and possibly result in a hazardous situation.

21. The microwave oven shall not be placed in a cabinet unless it has been tested in a cabinet.

22. The rear surface of appliances shall be placed against a wall.

23. **WARNING** : The appliance and its accessible parts become hot during use. Care must be taken to avoid touching heating elements. Children less than 8 years of age shall be kept away unless continuously supervised.

24. Do not use harsh abrasive cleaners or sharp metal scrapers to clean the oven door glass since they can scratch the surface, which may result in shattering of the glass.

25. Do not use steam cleaners inside the cavity.

Safety Information

Important – Please read these instructions fully before installation

1. The oven must be placed on a level surface.
2. The turntable and turntable ring assembly must always be used in the oven during cooking. Place the cookware gently on the turntable and handle it carefully to avoid possible breakage.
3. Incorrect use of dish for browning food may cause turntable to break.
4. Use only the specified bag size when using pre-prepared popcorn.
5. The oven has several built-in safety switches to ensure that the power remains off when the door is open. Do not tamper with these switches.
6. Do not operate the microwave oven when empty. Operating the oven with no food or food that is extremely low in moisture can cause fire, charring or sparking.
7. Do not cook bacon directly on the turntable. Excessive local heating of the turntable may cause the turntable to break.
8. The contents of feeding bottles and baby food jars are to be stirred or shaken and the temperature should be carefully checked before consumption, in order to avoid burns.
9. Do not heat narrow-necked containers, such as syrup or sauce bottles.
10. Do not attempt to deep-fry in your microwave oven.
11. Do not attempt home canning in this microwave oven as it is impossible to be sure all contents of the jar have reached boiling temperature.
12. Do not use this microwave oven for commercial purpose. This microwave oven is made for household use only.
13. Caution : Stir the liquid prior to and during heating / reheating, let liquid stand for at least 10 seconds after cooking and always take care when adding ingredients to hot liquids. Microwave heating of beverages can result in delayed eruptive boiling, therefore care must be taken when handling the container.
14. Check the food in the microwave oven frequently to avoid burning due to overheating.
15. Failure to maintain the oven in a clean condition could lead to deterioration of the surface which could adversely affect the life of the appliance and possibly result in a hazardous situation.
16. Stand at arm's length when opening the door to avoid scalding when steam or hot air is released.
17. ALWAYS allow an appropriate standing time after the oven has switched off according to the food being cooked to allow heat to distribute evenly throughout the food.
18. Use oven gloves when removing any cookware from oven to reduce chance of being burned or scalded.
19. Read and follow the specific: "precautions for avoiding possible exposure to excessive microwave energy".
20. As with most cooking appliances, close supervision is necessary to reduce the risk of a fire in the oven cavity.
 - a. If a fire should start or smoke is observed:
 - a. Keep the oven door closed.
 - b. Turn the oven off and unplug the appliance.
21. Eggs in their shell and whole hard-boiled eggs should not be heated in microwave ovens since they may explode, even after microwave heating has ended.
22. Do not overcook food. Regularly observe the oven if paper, plastic, or other combustible materials are used in the oven.
23. Do not use the oven cavity for storage purposes. Do not store items such as bread, cookies, paper products, etc. inside the oven.
24. Remove wire twist-ties and metal handles from paper or plastic containers/bags before placing them in the oven.
25. This oven must be earthed. Connect only to properly earthed outlet. See "earthing installation".
26. Install or locate this oven in accordance with the installation instructions provided.
27. Use this appliance only for its intended uses as described in the manual. Do not use corrosive chemicals or vapours in this appliance. This oven is specifically designed to heat or cook food. It is not designed for industrial or laboratory use.
28. Never allow children to use the oven without supervision unless adequate instructions have been given so that the children are able to use the oven in a safe way and understand the hazards of improper use.
29. If the supply cord or plug is damaged, or if the oven is not working properly or has been dropped it must be replaced or repaired by the manufacturer or its service agent or a similarly qualified person in order to avoid a hazard.
30. This appliance should be serviced only by qualified service technicians. Contact the nearest authorised service facility for examination, repair or adjustment.
31. Do not cover or block any vents on the oven.
32. Do not store or use this appliance outdoors.
33. Do not use this oven near water, near a kitchen sink, in a wet basement or near a swimming pool.
34. Do not immerse cord or plug in water.
35. Keep cord away from heated surfaces.
36. Do not let cord hang over edge of table or counter.
37. When cleaning door and oven surfaces use only mild, non-abrasive soaps or detergents applied with a sponge or soft cloth.
38. The contents of feeding bottles and baby food jars are to be stirred or shaken and the temperature should be carefully checked before consumption, in order to avoid burns.
39. Do not attempt to repair the oven yourself, please consult an authorised service agent.
40. Do not attempt to operate this oven with the door open since open-door operation can result in harmful exposure to microwave energy. It is important not to try an override or tamper with the safety interlocks.
41. Do not operate the oven if it is damaged. It is particularly important that the oven door closes properly and that there is no damage to the, (1) door (i.e. door is not bent or dented), (2) hinges and latches (broken or loosened), (3) door seals and sealing surfaces.
42. Utensils should be checked to ensure that they are suitable for use in microwave ovens.
43. The symbol  on the product or on its packaging indicates that this product may not be treated as household waste. Instead it shall be handed over to the applicable collection point for the recycling of electrical and electronic equipment. By ensuring this product is disposed of correctly, you will help prevent potential negative consequences for the environment and human health, which could otherwise be caused by inappropriate waste handling of this product. For more detailed information about recycling of this product, please contact your local city office, your household waste disposal service or the shop where you purchased the product.
44. The lamp holder must be serviced by an authorised service agent.
45. The oven should be cleaned regularly and any food deposits removed.
46. Do not use harsh abrasive cleaners or sharp metal scrapers to clean the oven door glass since they can scratch the surface, which may result in shattering of the glass.
47. Do not use steam cleaners inside the cavity.
48. During use the appliance becomes hot. Care should be taken to avoid touching heating elements inside the oven.
49. This appliance is not intended for use by persons (including children) with reduced physical, sensory or mental capabilities, or lack of experience and knowledge, unless they have been given supervision or instruction concerning use of the appliance by a person responsible for their safety.
50. The product is classified as a Group 2, Class B, ISM appliance. Group 2 includes all ISM (Industrial, Scientific or Medical) appliances in which radio frequencies are generated intentionally and/or used in the form of electromagnetic radiation to treat materials, together with electroerosion equipment. Class B includes equipment for domestic use or on premises directly connected to low voltage electricity supply for supplying buildings for residential use.
51. This appliance complies with EC directive 2004/108/EC on electromagnetic compatibility and European regulation no. 1935/2004 of 27/10/2004 on food contact materials.
52. Children should be supervised to ensure that they do not play with the appliance.
53. Material and accessories coming into contact with food conform to EC regulation 1935/2004.

MATERIALS YOU CAN USE IN MICROWAVE OVEN

Utensils	Remarks
Aluminium foil	Shielding only. Small smooth pieces can be used to cover thin parts of meat or poultry to prevent overcooking.
Arcing can occur if foil is too close to oven walls.	The foil should be a least 1 inch (2.5cm) away from oven walls.
Browning dish	Follow manufacturer's instructions. The bottom of browning dish must be at least 3/16 inch (5mm) above the turntable. Incorrect usage cause the turntable to break.
Dinnerware	Microwave-safe only. Follow manufacturer's instructions. Do not use cracked or chipped dishes.
Glass jars	Always remove lid. Use only to heat food until just warm. Most glass jars are not heat resistant and may break.
Glassware	Heat-resistant oven glassware only. Make sure there is no metallic trim. Do not use cracked or chipped dishes.
Oven cooking bags	Follow manufacturer's instructions. Do not close with metal tie. Make slits to allow steam to escape.
Paper plates and cups	Use for short-term cooking/warming only. Do not leave oven unattended while cooking.
Paper towels	Use to cover food for reheating and absorbing fat. Use with supervision for short-term cooking only.
Parchment paper	Use as a cover to prevent splattering or as a wrap during steaming.
Plastic	Microwave-safe only. Follow the manufacturer's instructions. Should be labelled "Microwave Safe". Some plastic containers soften as the food inside gets hot. "Boiling bags" and tightly closed plastic bags should be slit, pierced or vented as directed by package.
Plastic wrap	Microwave-safe only. Use to cover food during cooking to retain moisture. Do not allow plastic wrap to touch food.
Thermometers	Microwave-safe only (meat and sugar thermometers).
Wax paper	Use as a cover to prevent splattering and retain moisture.

MATERIALS TO AVOID USING IN THE MICROWAVE OVEN

Utensils	Remarks
Aluminium tray	May cause arcing. Transfer food into microwave-safe dish.
Food carton with metal handle	May cause arcing. Transfer food into microwave-safe dish.
Metal or metal-trimmed utensils	Metal shields the food from microwave energy. Metal trim may cause arcing.
Metal twist ties	May cause arcing and could cause a fire in the oven.
Paper bags	May cause a fire in the oven.
Plastic foam	Expanded polystyrene may melt or contaminate the liquid inside when exposed to high temperature.
Wood	Wood will dry out when used in the microwave oven and may split or crack.

UTENSILS

CAUTION

Personal Injury Hazard

Tightly-closed containers could explode. Closed containers should be opened and plastic pouches pierced before cooking.

See above for further instructions "Materials you can use in microwave oven or to avoid using in microwave oven." There may be certain non-metallic utensils that are not safe to use for microwaving. If in doubt, you can test the utensil in question by following the procedure below.

Utensil test:

1. Fill a microwave-safe container with 1 cup of cold water (250ml) along with the utensil in question.
2. Cook on maximum power for 1 minute.
3. Carefully feel the utensil. If the utensil is warm, do not use if for microwave cooking.
4. Do not exceed 1 minute cooking time.

Setting Up Your Oven

OVEN COMPONENTS AND ACCESSORIES

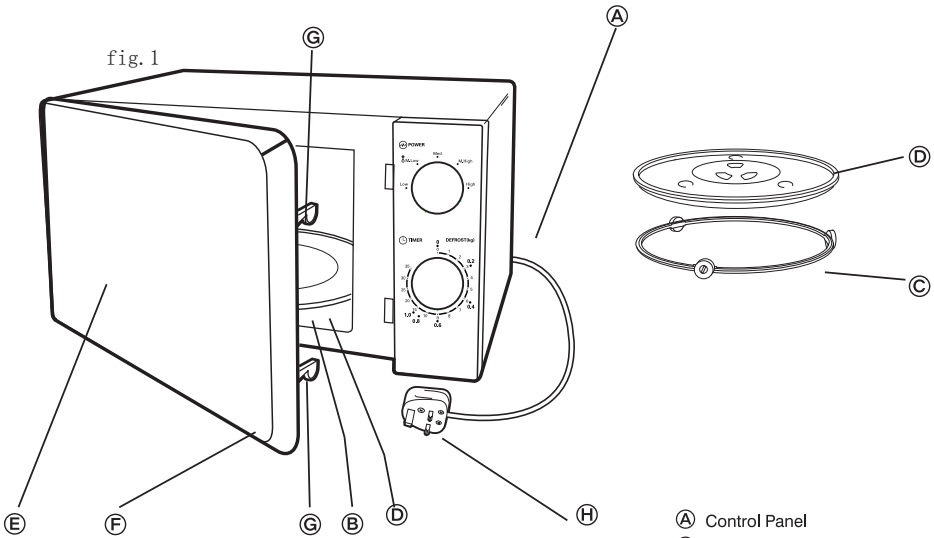

Remove the oven and all materials from the carton.

- A Control Panel
- B Turntable Shaft
- C Turntable Ring Assembly
- D Glass Turntable
- E Observation Window
- F Door Assembly
- G Safety Interlock System
- H Plug and Power Cord

NOTE: Oven power turns off automatically if door is opened during operation.

TURNTABLE INSTALLATION

- A Turntable Ring Assembly C .
To be placed in the centre of the oven to support the glass plate, (see Fig. 2)
 - B Hub. Rotates the glass plate D , (see Fig. 2)
 - C Glass Plate D . To be placed on the turntable ring with the centre fitting located on the hub. (see Fig. 2)
- a. Never place the glass turntable D upside down. The turntable should never be restricted in movement.
 - b. Both glass turntable D and turntable ring assembly C must always be used during cooking.
 - c. All food and containers of food should always be placed on the glass tray for cooking.
 - d. The glass turntable rotates clockwise or anti-clockwise randomly, this is normal.
 - e. If glass turntable or turntable ring assembly cracks or breaks, contact your nearest authorised service centre.

Warning : Do not remove the light brown Mica cover that is attached to the oven cavity to protect the magnetron.

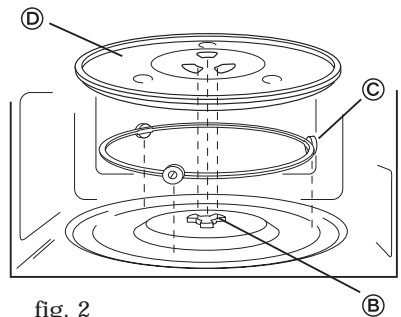

Setting Up Your Oven

Microwave cooking principles

1. The microwaves generated by the magnetron are evenly distributed through the food as the glass turntable revolves. This ensures that the food is cooked uniformly.
2. The microwaves are absorbed by the food up to a depth of approximately 1 inch (2.5cm). Cooking continues as the heat is dissipated through the food.
3. Cooking times will vary according to the recipe and the density, weight and water content of the food. The cooking time will also vary according to the temperature at the start of cooking, i.e. depending on whether the food is frozen or not.

Microwave Food packaging Symbols

Microwave Symbols:

On the front of your oven there is a microwave symbol, as shown below. This symbol has been introduced for your benefit when cooking or reheating packaged food.

Packaged food is also increasingly using a microwave symbol similar to the one below.

When you see this symbol on food packaging the cooking instructions are based on either IEC Power Output Rating, on the Reheating Categories A,B,C,D or E.

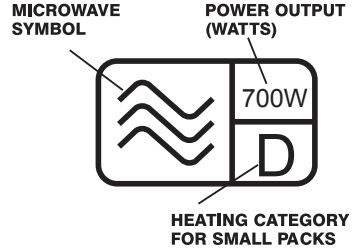

A, B, C, D or E

MORE HEATING TIME

LESS HEATING TIME

Accessories included

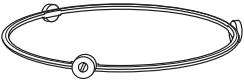

Turntable Ring Assembly



Glass Tray

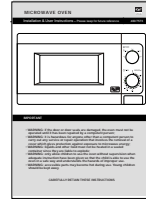

Instruction

Installation

Please Note Electrical connection

The oven is fitted with a plug and must be only connected to a properly installed earthed socket. In accordance with the appropriate regulations, the socket must only be installed and the connecting cable must only be replaced by a qualified electrician. If the plug is no longer accessible following installation and all-pole isolating switch must be present on the installation side with a contact gap of at least 3mm.

1. Select a level surface that provide enough open space for the intake and/or outlet vents.

The rear surface of appliance shall be placed against a wall.

One side must be open.

- (1) **Leave a minimum clearance of 12 inches (30cm) above the oven.**
 - (2) **Do not remove the legs from the bottom of the oven.**
 - (3) Blocking the intake and/or outlet openings can damage the oven.
 - (4) Place the oven as far away from radios and TV as possible. Operation of microwave oven may cause interference to your radio or TV reception.
2. Plug your oven into a standard household outlet. Be sure the voltage and the frequency is the same as the voltage and the frequency on the rating label.

WARNING: Do not install oven over a range cooktop or other heat-producing appliance. If installed near or over a heat source, the oven could be damaged and the warranty would be void.

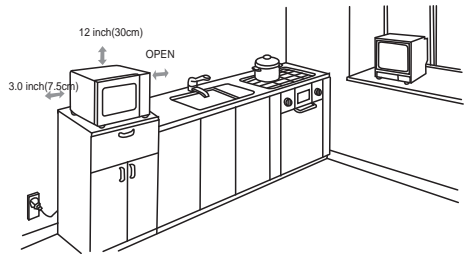

Installation

EARTHING INSTALLATION

DANGER

Electric Shock Hazard

Touching some of the internal components can cause serious personal injury or death.

Do not disassemble this appliance.

WARNING

Electric Shock Hazard

Improper earthing can result in electric shock.

Do not plug into an outlet until appliance is properly installed and earthed.

Three pin earthed plug Properly polarised and earthed outlet.

This appliance must be earthed. In the event of an electrical short circuit, grounding reduces the risk of electric shock by providing an escape wire for the electric current. This appliance is equipped with a cord having a grounding wire with a earthing plug. The plug must be plugged into an outlet that is properly installed and earthed.

Consult a qualified electrician or serviceman if the earthing instructions are not completely understood or if doubt exists as to whether the appliance is properly earthed. If it is necessary to use an extension cord, use only a 3-wire extension cord that has a 3 pin earthing plug, and a 3-slot socket which will accept the plug.

1. A short power-supply cord is provided to reduce the risks resulting from becoming entangled in or tripping over a longer cord.
2. If an extension cord is used:
 - a. The marked electrical rating of the extension cord should be at least as great as the electrical rating of the appliance.
 - b. The extension cord must be earthed, a 3-wire cord.
 - c. The extension cord should be arranged so that it will not drape over the worktop or tabletop where it can be pulled on by children or tripped over accidentally.

Check that the voltage marked on the product corresponds with your supply voltage.

This product is fitted with a 13 A plug complying with BS1363. If this plug is unsuitable or needs to be replaced, please note the following:

Important:The wires in the mains lead are coloured in accordance with the following code:

GREEN / YELLOW – EARTH,

BLUE – NEUTRAL, BROWN – LIVE

For UK use only

Plug fitting details (where applicable):

As the colours of the wires in the mains lead of this appliance may not correspond with the coloured markings identifying the terminals in your plug proceed as follows:

The GREEN/YELLOW wire is the EARTH and must be connected to the terminal which is marked with the letter (E) or by the earth symbol or coloured GREEN or GREEN/YELLOW.

The BLUE wire is the NEUTRAL and must be connected to the terminal marked with the letter (N) or coloured BLACK.

The BROWN wire is the LIVE and must be connected to the terminal marked with the letter(L) or coloured RED.

Always ensure that the plug cord grip is fastened correctly.

If a 13A (BS 1363) fused plug is used it must be fitted with a 13A fuse conforming to BS1362 and be ASTA approved.

If in doubt contact a qualified electrician.

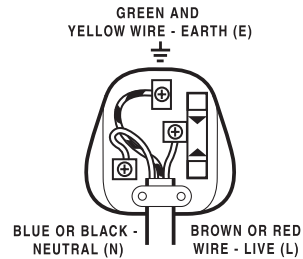

DANGER
Electric
Shock Risk

OPERATING YOUR MICROWAVE OVEN

CONTROL PANEL AND FEATURES

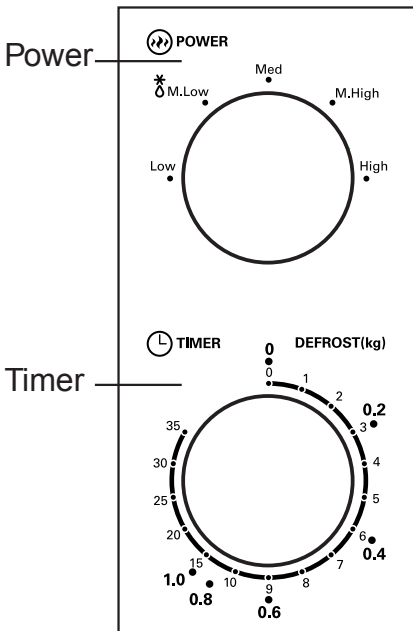

1. Set the cooking power by turning the power selection knob to desired level.
 2. Set the time of cooking by turning the timer knob to desired time per your food cooking guide.
 3. The microwave oven will automatically start cooking after power level and time is set.
 4. After the cooking time is up, the unit will "Ding" to stop.
 5. If the unit is not in use, always set time to "0" .
- NB: To set a time less than 1 min turn the control past the required setting, and then move the control, back.

Function/power	Output (%)	Application
120W/Low power	17% microwave	Keep food temperature, soften ice cream
 Med. Low(Defrost)	33% microwave	Defrost
385W/Medium power	55% microwave	Cook cream cake, braise food
540W/Med. High power	77% microwave	rice, fish and shell-fish, cookies, meat
700W/High power	100% microwave	Reheat, boil water, cook fresh vegetable, chickens ducks, heat non-milk drink

OPERATING YOUR MICROWAVE OVEN

Microwave cooking

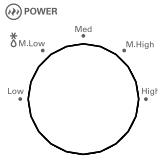

Turn power selection dial to Microwave cooking position.

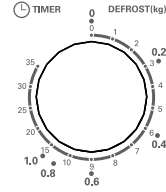

Set microwave cooking time by turning timer dial. To set a time less than 1 min turn the control past the required setting, and then move the control, back.

1. This function allows food to be cooked by microwave only.
2. Turn the power selection dial to select power level. Then set the time by turning the timer dial. Cooking will be started immediately.
3. To stop cooking, turn timer dial to zero position.
4. The glass turnable must always be in position when using the oven.
5. Always remember that cooking instructions are intended only as a guide. If you have followed the instructions and the food is still not piping hot throughout, simply return it to the oven and cook it until it is.

Defrost cooking

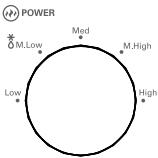

Turn power selection dial to Defrost position.

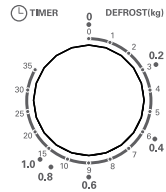

Set Defrosting time by turning timer dial.

1. The defrosting function is the gentle thawing of uncooked food.
2. Turn the power selection dial to Defrost position . Then set the time by turning the timer dial. Cooking will be started immediately.
3. After defrosting always check food to ensure that it has completely defrosted. If necessary some foods, particularly foods which have been in a deep freeze, may need extra defrosting time. You can cook some food from frozen.

CLEANING YOUR MICROWAVE OVEN

Attention

Your microwave oven should be cleaned regularly to prevent grease and food particles from building up on the inside surface. The accumulated grease / food particles may cause a fire hazard.

It is important to clean the interior of your microwave oven after each use.

To clean the oven interior, use a mild detergent solution, such as washing-up liquid, with warm water on a soft cloth.

It is suggested to place half a lemon in a bowl and add 300ml water inside the oven. Then heat it on 100% microwave power setting for 10 minutes. Wipe the oven clean with a soft, dry cloth.

IMPORTANT:

ALWAYS switch off oven and unplug from power supply.

ALWAYS use a branded cleaning spray, and for stubborn spots inside the oven, spray a small amount of cleaner onto a damp cloth.

DO NOT SPRAY DIRECTLY INSIDE THE OVEN.

Removable Parts

1. The turntable may be cleaned at the sink. Be careful not to chip or scratch the edges as this may cause the turntable to break during use.
2. The turntable roller rest should be cleaned regularly.
3. Do not immerse the turntable glass in cold water.

Special Care

For best performance and safety, the inner door panel and the oven front frame should be free of food residue. To prevent damage to the operating parts inside the oven, water should not be allowed to seep into the ventilation openings.

Troubleshooting and maintenance

NORMAL CONDITION

Microwave oven interfering with TV reception.

Radio and TV reception may be interfered with when microwave oven is in operation. It is similar to the interference of small electrical appliances such as food mixers, vacuum cleaners and electric fans. This is normal.

Oven light dim.

In low power microwave cooking, oven light may become dim. This is normal.

Steam accumulating on door, hot air out of vents.

In cooking, steam may come out of food. Most will come out from vents but some may condense on cool places such as the oven door. This is normal.

Oven started accidentally with no food in.

Although starting the oven with no food in it should be avoided, it does no damage to the oven provided it is only operated empty for a very short time. It is advised that a glass or microwave safe container of water is always left in the oven to absorb any heat should the oven be turned on accidentally.

MAINTENANCE

Troubleshooting

Check for problems by using the chart below. If the microwave oven still does not work properly, contact the nearest authorised service centre.

PROBLEM	POSSIBLE CAUSE
Oven will not start	<ol style="list-style-type: none">Plug not secure in power socket, or not switched on.Door is open.Wrong operation is set.
Arcing or sparking	<ol style="list-style-type: none">Materials which should be avoided in microwave oven are used.The oven is operated when empty.Spilled food remains in the cavity.
Unevenly cooked food	<ol style="list-style-type: none">Materials which should be avoided in microwave oven are used.Food is not defrosted completely.Power setting for cooking time is incorrect.Food is not turned or stirred.
Overcooked food	Power setting for cooking time is incorrect.
Undercooked food	<ol style="list-style-type: none">Materials to be avoided in microwave oven are used.Food is not defrosted completely.Oven ventilation ports are restricted.Power setting for cooking time is incorrect.
Incomplete defrosting	<ol style="list-style-type: none">Materials to be avoided in microwave oven are used.Power setting for cooking time is incorrect.Food is not turned or stirred.
Noise comes from turntable when oven is turned on	<ol style="list-style-type: none">Food residue exists between the turntable roller rest and cavity bottom.
Oven light does not glow	<ol style="list-style-type: none">The light bulb has burned out, a new bulb must be fitted by a qualified service engineer.START has not been pressed.

Questions And Answers

- Q: When the oven is plugged into a wall outlet for the first time, it does not work properly . What's wrong?
A: The microcomputer used in the oven control may temporarily become scrambled and fail to function as programmed. Unplug the oven from the wall outlet and then plug it back in. The microcomputer will then reset for proper functioning.
- Q: Why is there noise coming from the oven when using a lower power level?
A: When cooking with power other than 100%, the oven automatically switches on and off to obtain the correct power output. The clicking noise can be heard when the oven switches on and off . This is normal
- Q: Why is there steam coming out of the air exhaust vent?
A: Steam is produced during cooking. The microwave oven has been made to vent this steam.
- Q: What is wrong when the oven light will not glow?
A: There may be several reasons why the oven light will not glow . The light bulb has burned out or START has not been pressed.
- Q: Why do eggs sometimes burst?
A: The egg yolk may burst because of steam build-up inside the membrane. Pierce the membrane with a toothpick before cooking it. Never microwave eggs in the the shell as they may explode.
- Q: How is boiling over avoided?
A: Use a larger utensil than usual for cooking. If you open the oven door or touch STOP/CLEAR, the food will stop boiling.

Important Notes

1. Before first using this oven please read this instruction manual and keep it carefully .
2. Do not attempt to repair the oven yourself , please consult an authorised expert.
3. The contents of feeding bottles and baby food jars are to be stirred or shaken and the temperature should be carefully checked before consumption, in order to avoid burns.
4. Check the oven and the cable regularly for damage. If there is any kind of damage, the oven should not be used.

Warning:

- a. It is hazardous for anyone other than a trained person to carry out any service or repair operation which involves the removal of any cover which gives protection against exposure to microwave energy .
- b. Never allow children to use the oven without supervision unless adequate instructions have been given so that the children are able to use the oven in a safe way and understand the hazards of improper use.
- c. If the supply cord is damaged, it must be replaced by the manufacturer or its service agent or a similarly qualified person in order to avoid a hazard.

NOTE

- Do not attempt to operate this oven with the door open since open-door operation can result in harmful exposure to microwave energy. It is important not to try and override or tamper with the safety interlocks.
- Carefully clean door seals and sealing surfaces.
- Do not operate the oven if it is damaged. It is particularly important that the oven door closes properly and that there is no damage to the, (1) door (i.e. door is not bent or dented), (2) hinges and latches (broken or loosened), (3) door seals and sealing surfaces.
- Utensils should be checked to ensure that they are suitable for use in microwave ovens.
- When heating food in plastic or paper containers, check the oven frequently to avoid any possibility of ignition.
- Microwave heating of beverages can result in delayed eruptive boiling, therefore care has to be taken when handling the container.
- If smoke is observed, switch off or unplug the appliance immediately and keep the door closed in order to stifle any flames.
- Eggs in their shells and whole hard-boiled eggs should not be heated in microwave ovens since they may explode.
- If the door or door seals are damaged the oven must not be operated until it has been repaired by a trained person.
- Liquids or other foods must not be heated in sealed containers since they are liable to explode.
- Warning: Children should only use this oven under adult supervision.
- When heating food in plastic or paper containers, keep an eye on the oven due to the possibility of ignition.
- The temperature of accessible surfaces may be high when the appliance is operating. The surfaces are liable to get hot during use. Keep cord away from heated surface, and do not cover any events on the oven.
- Children should be supervised to ensure that they do not play with the appliance.
- The appliances are not intended to be operated by means of an external timer or separate remote-control system.

BULB REPLACEMENT

If the interior light bulb fails, it can be easily replaced by a qualified service engineer . Do not attempt to remove the outercasing, as this will expose live components. Please consult a qualified service engineer .

Technical Specifications

Model	MM717CNF (F) -PM
Power Source:	230-240 V~50Hz
Microwave Power Consumption:	1100-1150 Watt
Maximum Output:	650-700 Watt
Oven Capacity:	17 litres
Turntable Diameter:	Ø 255 mm
External Dimensions (L x W x H):	440mm x 335mm x 258mm
Net Weight:	Approx. 9.6 Kg

We apologise for any inconvenience caused by any minor inconsistencies in these instructions, which may occur as a result of product improvements and development.

Spare glass turntable and ring assembly can be ordered in www.argosspares.co.uk



PRODUCT GUARANTEE

This product is guaranteed against manufacturing defects for a period of



Year

This product is guaranteed for twelve months from the date of original purchase.

Any defect that arises due to faulty materials or workmanship will either be replaced, refunded or repaired free of charge where possible during this period by the dealer from whom you purchased the unit.

The guarantee is subject to the following provisions:

- The guarantee does not cover accidental damage, misuse, cabinet parts, knobs or consumable items.
- The product must be correctly installed and operated in accordance with the instructions contained in this manual.
- It must be used solely for domestic purpose.
- The guarantee will be rendered invalid if the product is re-sold or has been damaged by inexpert repair.
- Specifications are subject to change without notice.
- The manufacturer disclaims any liability for the incidental or consequential damages.
- The guarantee is in addition to, and does not diminish your statutory or legal rights.
- In the event of a problem with the product within the guarantee period call the Customer Helpline on 0845 640 0800.

Guarantor: Argos Ltd
489 - 499 Avebury Boulevard
Central Milton Keynes
MK9 2NW