

Guarantee

BUSH

PRODUCT GUARANTEE

This product is guaranteed against manufacturing defects for a period of



Year

This product is guaranteed for twelve months from the date of original purchase.

Any defect that arises due to faulty materials or workmanship will either be replaced, refunded or repaired free of charge where possible during this period by the dealer from whom you purchased the unit.

The guarantee is subject to the following provisions:

- The guarantee does not cover accidental damage, misuse, cabinet parts, knobs or consumable items.
- The product must be correctly installed and operated in accordance with the instructions contained in this manual.
- It must be used solely for domestic purpose.
- The guarantee will be rendered invalid if the product is re-sold or has been damaged by inexpert repair.
- Specifications are subject to change without notice.
- The manufacturer disclaims any liability for the incidental or consequential damages.
- The guarantee is in addition to, and does not diminish your statutory or legal rights.

Guarantor: Argos Limited
489 - 499 Avebury Boulevard
Central Milton Keynes
MK9 2NW

BUSH

Instruction Manual CH-965



Table of contents

Safety Warnings	2
Safety Warnings	3
Accessories included	4
Overview of controls	4
Recharging information	5
Emptying your Cleaner	5
Operating instructions	5
Operating instructions (cont)	6
Cleaning & maintenance	6
Wall mounting instructions	7
Wall mounting & fixings	8
Care & maintenance	9
Purchasing replacement filters	9
Troubleshooting	9
Rechargeable battery disposal	9
Technical specifications	9

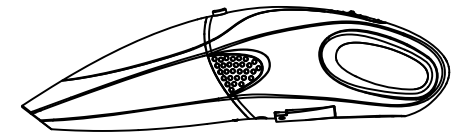

Product Codes

CH-965

MuseoSansRounded-100

Safety information

Important – Please read these instructions fully before installation

Safety Warnings

IMPORTANT SAFETY INSTRUCTIONS

We recommend this product is not used by children and please read the instruction booklet for further information.

When using an electrical appliance, basic safety precaution should always be observed, including the following.

PLEASE READ ALL INSTRUCTIONS CAREFULLY BEFORE USING THE PRODUCT, AND KEEP FOR FUTURE REFERENCE.

FOR HOUSEHOLD USE ONLY!

WARNING: To reduce the risk of fire, electrical shock or injury:

- 1: User must read & understand instructions prior to usage of this product. Use only as described in this manual. Use manufacturer's original accessories only.
- 2: Follow all label and marking instructions on your Vacuum Cleaner.
- 3: Do not use or recharge the Vacuum Cleaner outdoors.
- 4: Do not pick up anything that is burning or smoking, such as cigarettes, matches. This is a fire risk

- 5: Do not use the Vacuum Cleaner to pick up flammable or combustible liquids.
- 6: Do not use in an area where dangerous items are stored.
- 7: Do not handle or use the Vacuum or Battery Charging Adapter with wet hands
- 8: Do not use the Vacuum when it is plugged in to a mains socket
- 9: Do not use the Vacuum without a filter in place.
- 10: While vacuuming, do not block the air-intake, or the exhaust vents of the Vacuum. This could cause the motor to overheat and malfunction.
- 11: Take care in keeping all body parts (hair, fingers & clothing) away from moving parts & openings.
- 12: Keep the air-intake (nozzle); exhaust vents, crevice tool & brush away from your face and body & loose clothing.
- 13: Take care when vacuuming stairs.
- 14: Do not charge if the charger plug or cable is damaged in any way.
- 15: Plug the charging unit directly into a mains wall socket; do not use an extension cable.
- 16: Store the Vacuum (indoors) correctly after use to avoid accidents.

BUSH

Safety information

Important – Please read these instructions fully before installation

- 17: This vacuum includes re-chargeable NI-MH cells. DO not incinerate cells or expose to high temperatures, as they may explode.
- 18: Do not remove the battery pack yourself. Take the entire Vacuum to qualified service engineer.
- 19: Use only the attachments & charging adapter supplied by the manufacturer
- 20: Do not continue to use this Vacuum if it appears to be malfunctioning
- 21: If the Vacuum malfunctions, or is damaged in any way it should be taken to a qualified service engineer for repair.
- 22: Do not apply lubricants to the motor of the Vacuum Cleaner
- 23: Leakage of ingredients contained within the battery pack, can cause personal injury as well as damage to your Vacuum. If battery leakage occurs, avoid contact with skin. If contact occurs, immediately wash thoroughly with soap and water. If liquid leaking from a battery pack comes into contact with your eyes, immediately flush thoroughly with water and see a doctor.
- 24: The Vacuum Cleaner is not a toy, keep away from small children.
- 25: Do not abuse the charger cable. Never carry the charger or base by the cable or pull to disconnect from a socket. Instead grasp the plug and pull to remove.
- 26: Keep the charger away from hot surfaces.
- 27: Do not insert objects into openings. Do not use with openings blocked; keep free of dust, lint & hair. Anything that may reduce air flow.
- 28: Do not attempt to use the charger with any other product nor attempt to charge this product with another charger. Use only the charger supplied with this product.
- 29: Do not use this Vacuum while charging.
- 30: This appliance can be used by children aged from 8 years and above and persons with reduced physical, sensory or mental capabilities or lack of experience and knowledge if they have been given supervision. Children shall not play with the appliance. Cleaning and user maintenance shall not be made by children without supervision.

BUSH

Functions & controls

Please familiarise yourself with the parts and accessories listed below

Accessories included

- 1 X CH-965 Vacuum
- 1 X Power Brush
- 1 X Wall Bracket with Adaptor
- 1 X Instruction Manual
- 1 X Crevice Tool
- 2 X Screws & Plugs

Overview of controls

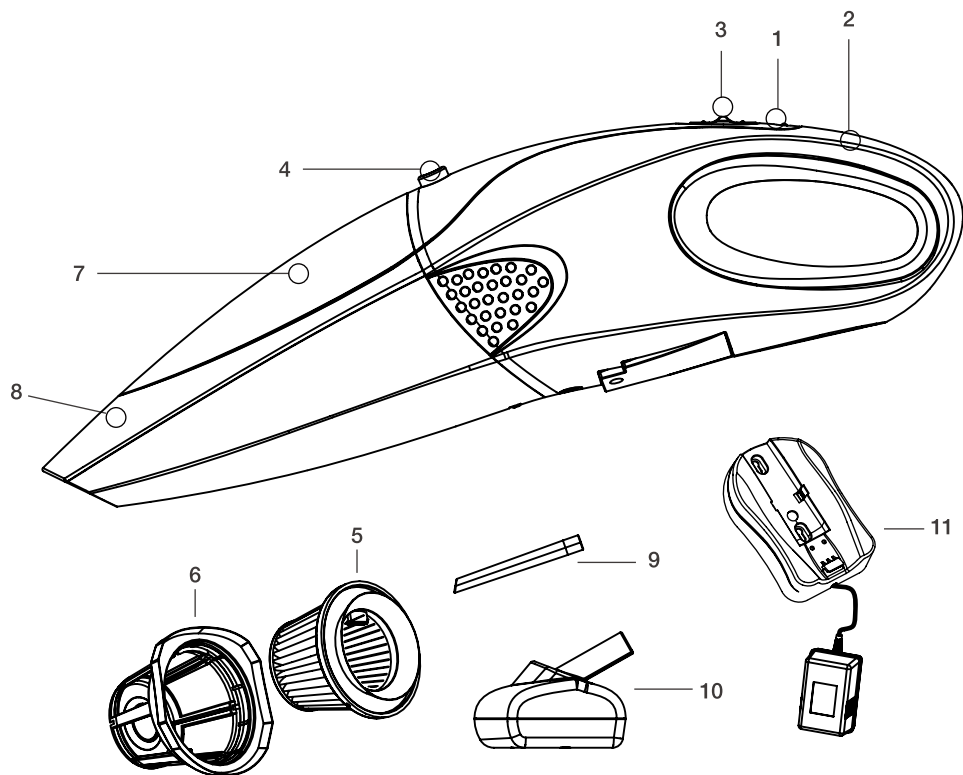

Features:

- | | | |
|-----------------------|-------------------------|-------------------------------|
| 1. Charging Indicator | 6. Outer Filter | 11. Wall Bracket with Adaptor |
| 2. Handle | 7. Dust Compartment/Bin | |
| 3. On/Off Switch | 8. Inlet | |
| 4. Release Button | 9. Crevice Tool | |
| 5. Inner Filter | 10. Power Brush | |

User instructions

Note : For Dry Use Only

Recharging information

- **Before using for the first time** charge the vacuum cleaner for at least 14 hours. The recommended duration for each subsequent charge is 14 hours to maintain maximum performance from the internal battery.

NOTE: The LED indicator will illuminate during charging.

- **To maintain peak performance** - We recommend discharging the Vacuum battery fully at least once a month and then charging for the full 14 hours.
- **Recommendation for efficient cleaning** - Please keep the usage time to no more than 10 minutes each time.

IMPORTANT

- The air vents must not be blocked at any time. Blocking the vents may cause overheating which will damage the motor.
- We recommend you clean the dust filter after each use.
- Do not use on liquids.

We strongly recommend following our easy Care and Cleaning instructions. This will optimise the performance of your hand vacuum and prolong its operating life.

Emptying your Cleaner

Note: Always switch 'OFF' before opening your hand-held vacuum cleaner.

1. Press the release button down and detach the dust compartment.
2. Remove the filters from the dust compartment and empty the container.

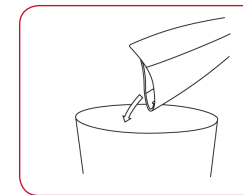
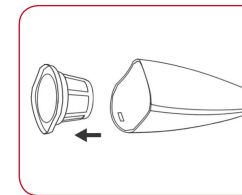
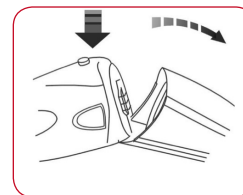

3. Gently tap out each of the filter to dislodge any dust and debris. A soft brush can be used to gently remove any dirt and dust from the filter.

To clean the filter more thoroughly, you can rinse them with cold or tepid water.

Ensure the filter parts are correctly fitted together, before putting back into the dust compartment. This will make the task easier. Maximum dust collection will only be obtained with clean filter/s and an empty dust compartment replacing back into the vacuum.

Operating instructions

USAGE IN DRY CONDITIONS

- 1: Lift and remove the Vacuum from the charging dock.
- 2: Attach the **BRUSH** or **CREVICE** attachments to the **SUCTION NOZZLE** to reach confined spaces or brush the particles.
- 3: Switch the Vacuum **ON** using the **ON/OFF** switch.

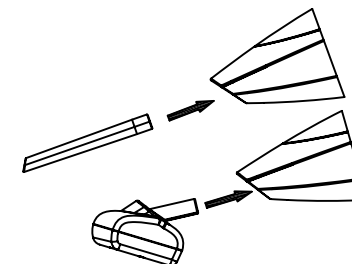

- 4: Replace the cleaner on the charging dock after use. The **LED** indicator will illuminate to indicate the vacuum is being charged.

User instructions

Cleaning & maintenance

REMOVING THE DUST CONTAINER

- 1: Press the **DUST CONTAINER RELEASE BUTTON** on the top of the handle, and slide the **DUST CONTAINER** away from the motor section.

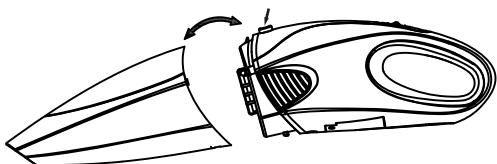

- 2: To re-fit the **DUST CONTAINER**, slide the **CONTAINER** back onto the motor section until it locates the bottom pip first and then locate the hole in the top of the **DUST CONTAINER**, it will then click into place.

NOTE: This Vacuum is intended for **NORMAL** household usage only.

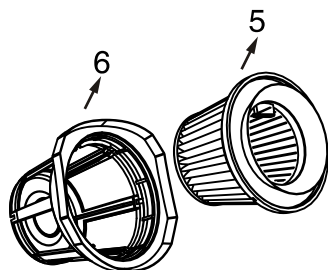

Cleaning & maintenance (cont)

CLEANING THE DUST CONTAINER & FILTER

- 1: Remove the **DUST CONTAINER** (see step 1 of removing the dust container),
- 2: Remove the **FILTER** by sliding the entire plastic section out of the largest end of the **CONTAINER**.

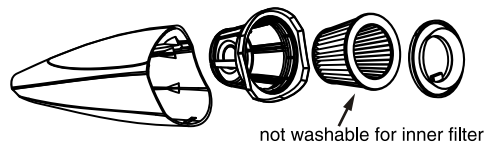

- 3: Clean the **DUST FILTER** section and if required the inside of the **DUST CONTAINER**.
- 4: Re-fit the **FILTER** inside the **CONTAINER** (Ensure the filter is pushed fully up to the stops inside the container) and follow step 2 of 'removing the dust container' to re-fit the **DUST CONTAINER**.

REPLACING THE FILTER

After time the filter will become clogged with particles and will require changing. Follow the below steps to replace the dust filter,

- 1: Follow steps 1-3 to remove & clean the **DUST FILTER**.
- 2: The outer filter (6) can be cleaner using a soft brush to remove any dust/debns.
- 3: Insert the replacement filter block(5)
- 4: Once secure push the **FILTER** back inside the **DUST CONTAINER** until fitted snugly.

NOTE: Replacement filters are available to purchase. Please see details in the rear of this manual.

User instructions

Wall mounting instructions

See the below diagram for wall mounting the charging dock, Further fixing instructions can be found on pg 8.

- 1: Insert the wall fixings supplied (or suitable fixings as described on page 8) shown to below.

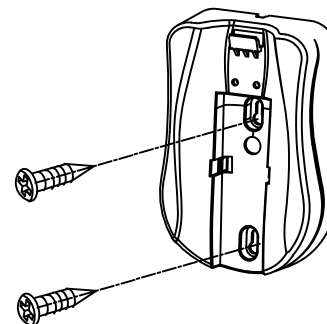

- 2: Dock the Vacuum as show on the diagram below. Ensure the Charging dock is mounted with the **JACK** pointing vertically upwards to ensure the Vacuum remains seated when docked.

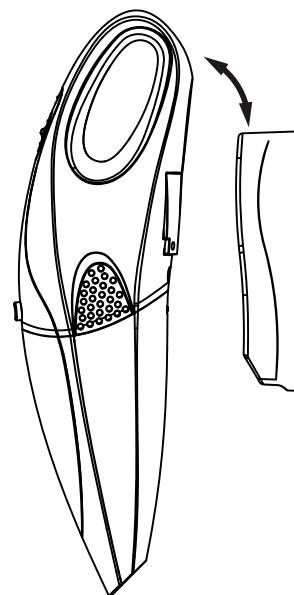

A Guide to

Wall Mounting & Fixings

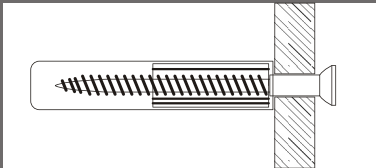

IMPORTANT:

When drilling into walls always check that there are no hidden wires or pipes etc. Make sure that the screws and wall plugs being used are suitable for supporting your unit. Consult a qualified tradesperson if you are unsure.

HINTS:



Always use a larger screw and wall plug if you are not sure.

- 1) General Rule
- 2) Ensure you use the recommended drill bit to match the wall plug and hole size.
- 3) Ensure you drill the hole horizontally, do not force the drill or enlarge the hole.
- 4) Take extra care when drilling high walls, ceilings and ceramic tiles. Ensure the plug is fitted below a ceramic tile to avoid splitting or cracking.
- 5) Ensure wall plugs are well fitted and are a tight fit in the drilled hole.

Types of Walls

You can use one of the following types of wall plug if your walls are made of brick, breeze block, concrete, stone, wood or plaster board.

No.1 "Standard" Wall Plug General Wall Materials

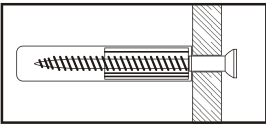

These come in various sizes and are made from plastic or sometimes wood fibre.

No.2 "General Purpose" Wall Plug Aerated / Breeze Block

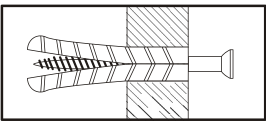

Generally aerated blocks should not be used to support heavy loads. Use a specialist fitting in this case. For light loads, a general purpose plug can be used.

No.3 "Shield Anchor" Wall Plug Heavy Loads

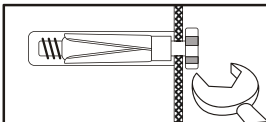

For use with heavier loads such as TV, Hi-Fi speakers & Satellite dishes etc.

No.4 "Cavity Fixing" Wall Plug

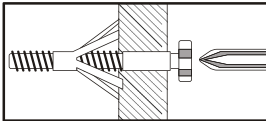

For use with plaster board partitions or hollow wooden doors.

No.5 "Cavity Fixing - Heavy Duty" Wall Plug

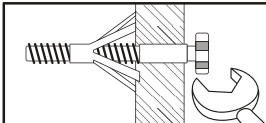

For use when fitting or supporting heavy loads such as shelving, wall cabinets & coat racks.

No.6 "Hammer Fixing" Wall Plug

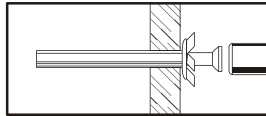

For use with walls stuck with plaster board. The hammer fixing allows it to be fixed to the wall rather than the plaster board. Always check the fixing is secure to the retaining wall.

CARE & MAINTENANCE



SAFETY

Always check the fitting and location to ensure your safety in and around the home.



FITTING

From time to time check the fitting to ensure the wall plugs or screws do not become loose.

User instructions

Care & maintenance



Important: Always unplug the appliance from the power socket during cleaning and maintenance. Never use any sharp instruments or abrasive substances, soap, household cleaner, detergent or wax polish for cleaning.

Clean the external surfaces with a damp soft cloth only. Never use abrasive products or solvents as they may damage the appliance.

Purchasing replacement filters

Replacement filters are available for Purchase. If you would like to purchase a filter please phone 08432 899160 between the hours of 9am-5pm Mon-Fri

Troubleshooting

In the unlikely event of difficulties with your appliance please follow the trouble shooting guide below. If the problem persists, contact the retailer if the machine is still under guarantee.

Customer helpline: **0345 604 0105 between the hours of 8am - 7pm Mon - Sat and 10am - 4pm Sun**

Problem	Reason(s)	Solution(s)
No Power	• Battery is drained	• Charge the battery fully
Low or no suction power	• Battery is drained • Dust container is full • Filter is clogged	• Charge the battery fully • Empty the container (see page 6) • Clean the filter (see page 6)
Dust leaking from the unit	• Dust container is full • Dust container is not fitted to the motor section correctly	• Empty the container (see page 6) • Re-fit the Dust container (see page 6)

Rechargeable battery disposal

DO NOT use ordinary batteries for replacements. These may leak and damage the Vacuum cleaner and cause personal injury.

In order to preserve the ecology please dispose of this unit properly so that it can be recycled.

Do not dispose of to unsorted waste.

For more detailed information about recycling of this product or battery, please contact your local Civic Office, your household waste disposal service or the shop where you purchased the product.

Technical specifications

Motor	• 12V 72W
Battery Charger Rating	• Input 100-240V~50/60Hz 0.3A
Battery Charger Voltage	• 17V 0.3A
Charging Rate	• 14 Hours(Approx)
Battery Pack	• Ni-MH AA 12V (1.2V x 10) 1200mAH