

Lamp Table

Assembly Instructions - Please keep for future reference

389/5690

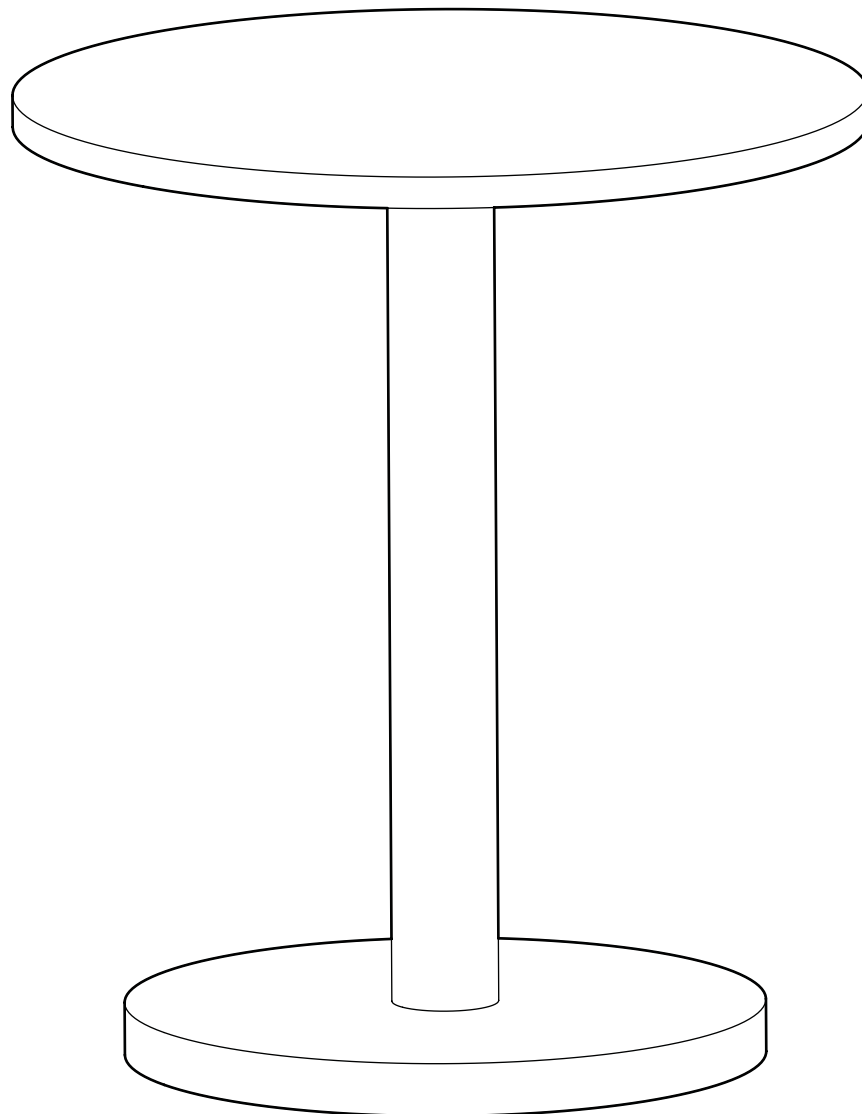

Dimensions

Width - 40cm
Height - 45.8cm

Important - Please read these instructions fully before starting assembly

If you need help or have damaged or missing parts, call the **Customer Helpline**
Argos = 0345 6400800



Safety and Care Advice

Important - Please read these instructions fully before starting assembly

- Check you have all the components and tools listed on the following pages.
- Remove all fittings from the plastic bags and separate them into their groups.
- Keep children and animals away from the work area, small parts could choke if swallowed.
- Make sure you have enough space to layout the parts before starting.

- During assembly do not stand or put weight on the product, this could cause damage.
- Assemble the item as close to its final position (in the same room) as possible.
- Assemble on a soft level surface to avoid damaging the unit or your floor.
- Parts of the assembly will be easier with 2 people.



- We do not recommend the use of power drill/ drivers **for inserting screws**, as this could damage the unit. Only use hand screwdrivers.

Care and maintenance

- Only clean using a damp cloth and mild detergent, do not use bleach or abrasive cleaners.
- From time to time check that there are no loose screws on this unit.
- This product should not be discarded with household waste. Take to your local authority waste disposal centre.

Handy Hints

- Assemble all parts and bolts loosely during assembly, only once the product is complete should you fully tighten the bolts
- Regularly check and ensure that all bolts and fittings are tightened properly.

Components - Panels

If you have damaged or missing components, call the **Customer Helpline Argos = 0345 6400800**

Please check you have all the panels listed below

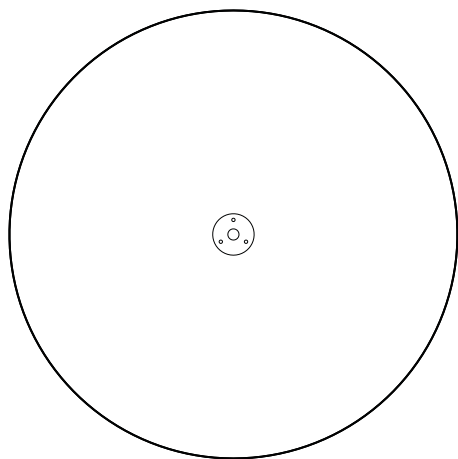

1 Top panel x 1 (40 x 15cm)

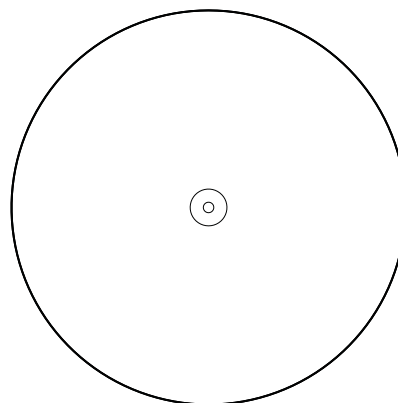





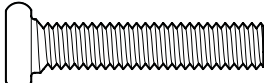

2 Bottom panel x 1 (30 x 25cm)

Components - Fittings

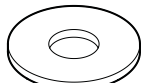
Please check you have all the fittings listed below

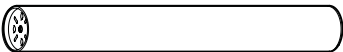
Note: The quantities below are the correct amount to complete the assembly. In some cases more fittings may be supplied than are required.

A  38mm bolt x 1	B  13mm Spring Washer x 1	C  21mm Metal Washer x 1
D  50mm Double head bolt x 1	E  Metal tube x 1	F  Allen Wrench x 1

Ruler - Use this ruler to help correctly identify the screws

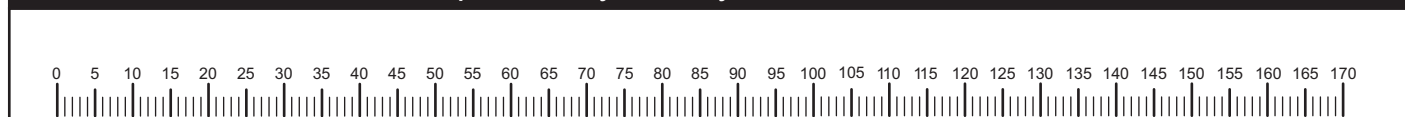

The screws length is measured from the head to the point (30mm screw shown).

Assembly Instructions

Step 1

Attaching bottom panel and metal tube.

Attaching bottom panel **2** and metal tube **E** by screw **A**. Be ware of the sequence of the washers **B** and **C**.

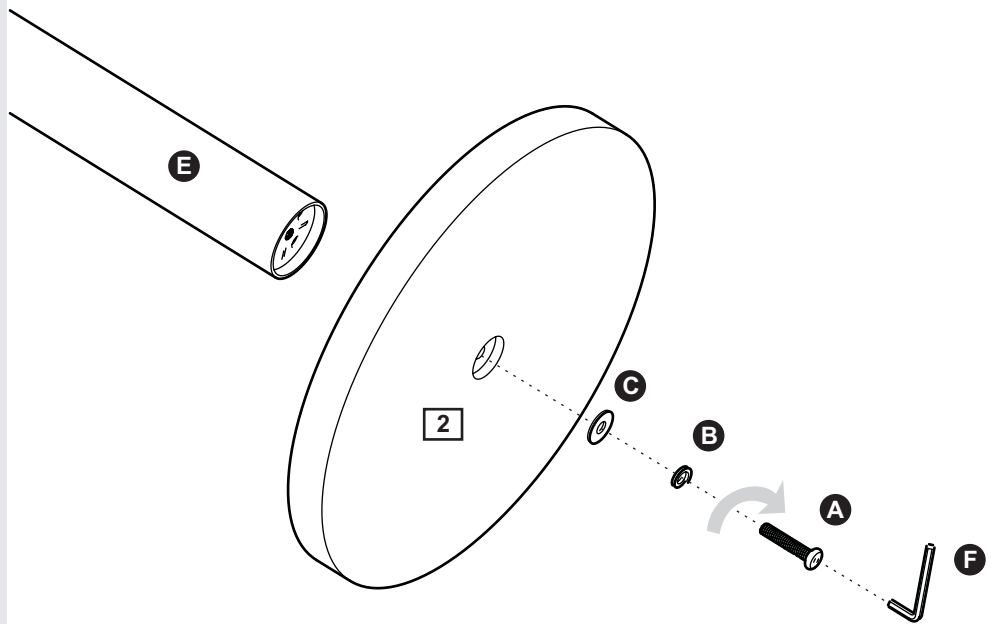

Step 2

Fitting the bolt

Insert the double head bolt **D** into top panel **1**.

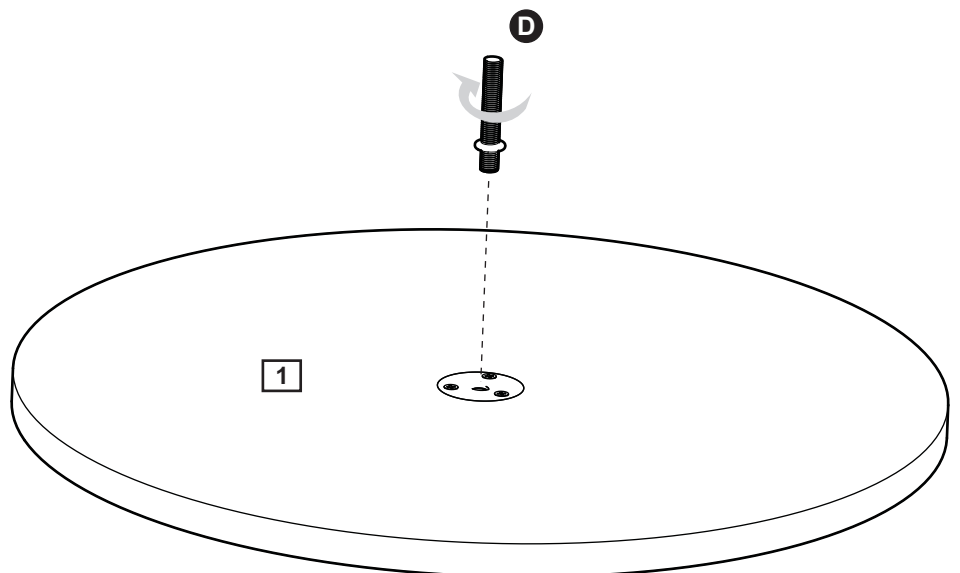

Assembly Instructions

Step 3

Fitting the Top panel

Turn the top panel onto the unit until tight.

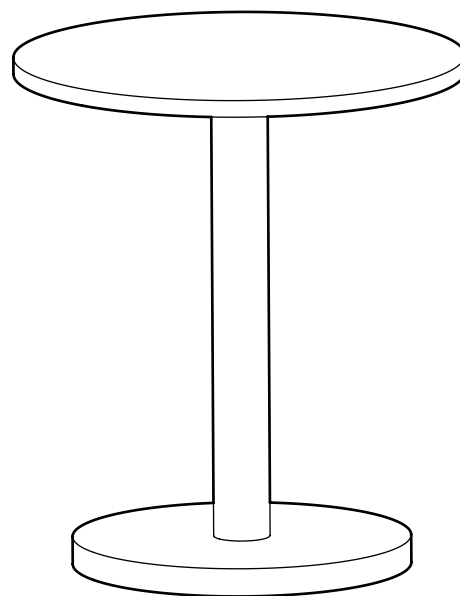
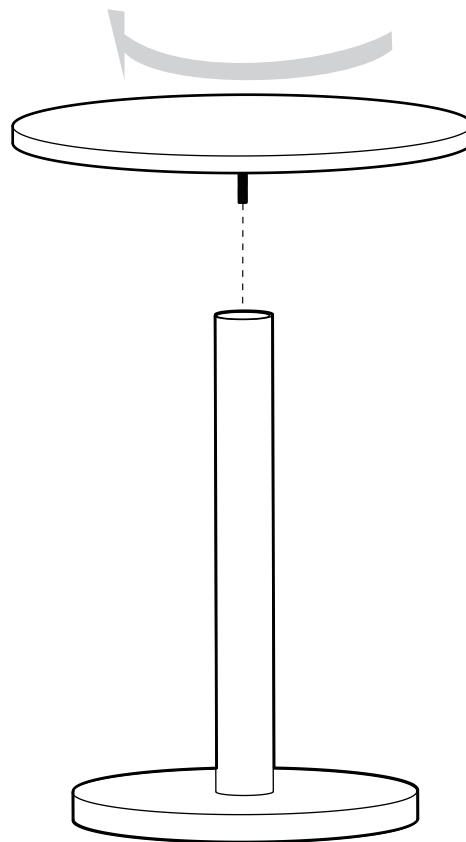

Assembly is complete.

If you need help or have damaged or missing parts, call the **Customer Helpline**
Argos = 0345 6400800