

SHARP®

LC-32LD171K
LC-40LD271K
LC-50LD271K

LCD COLOUR TELEVISION

OPERATION MANUAL



AQUOS

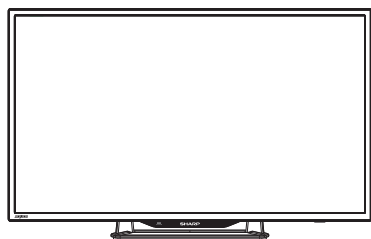

LC-32LD171K



LC-40LD271K LC-50LD271K



Contents

Contents	1	Teletext Setup	8
Introduction	1	Common Interface	8
Dear SHARP customer	1	Network	8
Important Safety Precautions	2	Interaction CH	8
Trademarks	3	MHEG PIN Protection	8
Remote control unit	4	Internet Connection	8
Preparation and Watching TV	5	Information	8
Using the remote control	5	IP Setup	8
Select an item by the remote control	5	Connection Test	9
Run the auto installation	5	OAD (Manual Software Download)	9
Daily operation	5	Power Control	9
Turning on/off the power	5	Audio Only	9
Changing channels	5	Power Saving	9
Standby mode	5	No Operation To Sleep	9
Selecting external video source	5	CEC Setup	9
Operation without a remote control	6	Location	9
EPG (Electronic Programme Guide)	6	Input Labels	9
Teletext	6	Icon Light Up Setting	9
Using the MHEG5 application	6	Version Info	9
TV menu	7	Reset	9
Picture	7	Parental	9
Adjust picture settings	7	CH Block	9
Use Smart Picture	7	Age Rating	9
Reset to Defaults	7	Change password	9
Sound	7	Clear all parental settings	9
Adjust sound settings	7	Connecting a USB device or external devices ..	10
Use Sound Mode	7	USB function	10
Reset to Defaults	7	Basic Operation	10
TV	7	View Photos	10
Select a digital audio language	7	Listen to Music	10
Auto CH Search	7	Play Videos	10
Update CH	8	USB device compatibility	10
DVB-T Single RF Scan	8	Inserting the Smartcard into CA module	11
Favourites CH	8	Checking CA module information	11
CH Skip	8	HDMI connection	11
CH Sort	8	Audio return channel (ARC)	11
CH Edit	8	Supported display resolutions	11
Clean CH List	8	Appendix	12
Setup	8	Troubleshooting	12
Language	8	Environmental specifications	12
View Mode	8	Specification	13
Time Setup	8		
Subtitle Setup	8		

Introduction

Dear SHARP customer

Thank you for your purchase of the SHARP LCD colour TV product. To ensure safety and many years of trouble-free operation of your product, please read the **Important Safety Precautions** carefully before using this product.

Introduction

Important Safety Precautions

- Cleaning—Unplug the AC cord from the AC outlet before cleaning the product. Use a damp cloth to clean the product. Do not use liquid cleaners or aerosol cleaners.
- Use a soft damp cloth to gently wipe the panel when it is dirty. To protect the panel, do not use a chemical cloth to clean it. Chemicals may cause damage or cracks in the cabinet of the TV.
- Water and moisture—Do not use the product near water, such as bathtub, washbasin, kitchen sink, laundry tub, swimming pool and in a wet basement.
- Do not place vases or any other water-filled containers on this product. The water may spill onto the product causing fire or electric shock.
- Stand—Do not place the product on an unstable cart, stand, tripod or table. Doing so can cause the product to fall, resulting in serious personal injuries as well as damage to the product. Use only a cart, stand, tripod, bracket or table recommended by the manufacturer or sold with the product. When mounting the product on a wall, be sure to follow the manufacturer's instructions. Use only the mounting hardware recommended by the manufacturer.
- When relocating the product placed on a cart, it must be moved with utmost care. Sudden stops, excessive force and uneven floor surface can cause the product to fall from the cart.
- Ventilation—The vents and other openings in the cabinet are designed for ventilation. Do not cover or block these vents and openings since insufficient ventilation can cause overheating and/or shorten the life of the product. Do not place the product on a bed, sofa, rug or other similar surface, since they can block ventilation openings. This product is not designed for built-in installation; do not place the product in an enclosed place such as a bookcase or rack, unless proper 10 cm ventilation is provided or the manufacturer's instructions are followed.
- The LCD panel used in this product is made of glass. Therefore, it can break when the product is dropped or impact applied. If the LCD panel is broken, be careful not to be injured by broken glass.
- Heat sources—Keep the product away from heat sources such as radiators, heaters, stoves and other heat-generating products (including amplifiers).
- To prevent fire, never place any type of candle or naked flames on the top or near the TV set.
- To prevent fire or shock hazard, do not place the AC cord under the TV set or other heavy items.
- Headphones—Do not set the volume at a high level. Hearing experts advise against extended listening at high volume levels.
- Do not display a still picture for a long time, as this could cause an afterimage to remain.
- There is power consumption always if main plug is connected.
- Servicing—Do not attempt to service the product yourself. Removing covers can expose you to high voltage and other dangerous conditions. Request a qualified person to perform servicing.
- "The mains plug or appliance coupler is used as the disconnect device, the disconnect device shall remain readily operable." or equivalent.
- Apparatus shall not be exposed to dripping or splashing and no objects filled with liquids, such as vases, shall be placed on the apparatus.

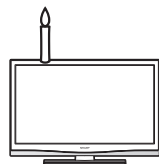
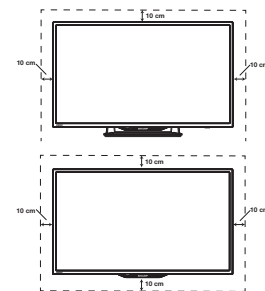

The LCD panel is a very high technology product, giving you fine picture details.

Due to the very large number of pixels, occasionally a few non-active pixels may appear on the screen as a fixed point of blue, green, red or yellow. This is within product specifications and does not constitute a fault.

Precautions when transporting the TV

When transporting the TV, never carry it by putting pressure onto the display. Be sure to always carry the TV by two people holding it with two hands—one hand on each side of the TV.

Wall mounting

- Installing the LCD Colour TV requires special skill that should only be performed by qualified service personnel. Customers should not attempt to do the work themselves. SHARP bears no responsibility for improper mounting or mounting that results in accident or injury.
- At the time of purchasing wall bracket, please check if there is enough space between the wall bracket and TV terminals for the terminal connection

WARNING

To prevent the spread of fire, keep candles or other open flames away from this product at all times.

“Excessive sound pressure from earphones and headphones can cause hearing loss. Adjustment of the equalizer to maximum increases the earphones and headphones output voltage and therefore the sound pressure level.” or equivalent.

**Cautions regarding use in high and low temperature environments**

- When the unit is used in a low temperature space (e.g. room, office), the picture may leave trails or appear slightly delayed. This is not a malfunction, and the unit will recover when the temperature returns to normal.
- Do not leave the unit in a hot or cold location. Also, do not leave the unit in a location exposed to direct sunlight or near a heater, as this may cause the cabinet to deform and the LCD panel to malfunction.
- Storage temperature: +5°C to +35°C.

Devices connected to the protective earthing of the building installation through the MAINS connection or through other devices with a connection to protective earthing and to a television distribution system using coaxial cable, may in some circumstances create a fire hazard. Connection to a television distribution system therefore has to be provided through a device providing electrical isolation within a certain frequency range (galvanic isolator, see EN 60728-11).

NOTE

- For requirements in **Norway** and **Sweden**, the requirements for isolation are also relevant for devices that can be connected to television distribution systems.

Dichiarazione di conformità Questo apparecchio è fabbricato nella Comunità Economica Europea nel rispetto delle disposizioni di cui al D. M. 26/03/92 ed in particolare è conforme alle prescrizioni dell'art. 1 dello stesso D.M. Si dichiara che l'apparecchi.

CAUTION

Improper use of batteries can result in chemical leakage or explosion. Be sure to follow the instructions below:

- Do not mix batteries of different types. Different types of batteries have different characteristics.
- Do not mix old and new batteries. Mixing old and new batteries can shorten the life of new batteries or cause chemical leakage in old batteries.
- Remove batteries as soon as they have worn out. Chemicals that leak from batteries can cause a rash. If you find any chemical leakage, wipe thoroughly with a cloth.
- The batteries supplied with this product may have a shorter life expectancy due to storage conditions.

Note on disposing batteries:

The batteries provided contain no harmful materials such as cadmium, lead or mercury.

Regulations concerning used batteries stipulate that batteries may no longer be thrown out with the household rubbish. Deposit any used batteries free of charge into the designated collection containers set up at commercial businesses.

Trademarks

- HDMI, the HDMI logo and High-Definition Multimedia Interface are trademarks or registered trademarks of HDMI Licensing LLC.
- The “HD TV” Logo is a trademark of DIGITALEUROPE.
- The “HD TV 1080p” Logo is a trademark of DIGITALEUROPE.
- The DVB logo is the registered trademark of the Digital Video Broadcasting - DVB - project.
- Manufactured under license from Dolby Laboratories.
- Dolby and the double-D symbol are trademarks of Dolby Laboratories.
- Manufactured under license under U.S. Patent Nos: 5,956,674; 5,974,380; 6,487,535 & other U.S. and worldwide patents issued & pending. DTS, the Symbol, & DTS and the Symbol together are registered trademarks & DTS 2.0+Digital Out is a trademark of DTS, Inc. Product includes software. © DTS, Inc. All Rights Reserved.

Introduction

Remote control unit

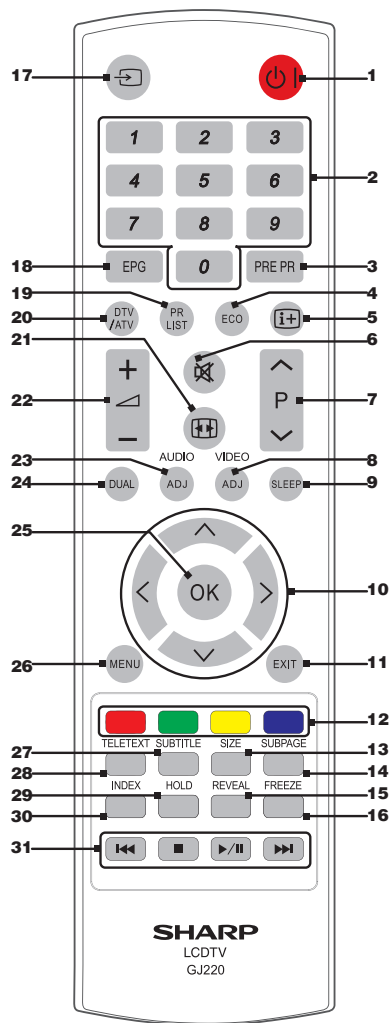

1. **⏻ (POWER)**

Press to turn the LCD TV on or to enter standby mode.

2. **0-9 DIGIT BUTTONS**

Press to select a TV channel directly.

3. **PRE PR**

Press to display the previous selected TV channel.

4. **ECO**

Press to switch **Power Saving** between **On** and **Off**.

5. **i+**

Press to display programme information, if available.

6. **🔇**

Press to toggle audio on and off. You can also press **⏮ (+/-)** to restore the previous volume level.

7. **P (^/∨)**

Press to select programme channel.

8. **VIDEO (ADJ)**

Press to set the LCD TV to a predefined picture setting: **Dynamic / Standard / Movie / Power Saver**.

9. **SLEEP**

Press to turn the LCD TV off within an amount of time (10 ~ 120 minutes.)

10. **^∨<>**

Press to navigate and confirm your selection.

11. **EXIT**

Press to exit the LCD TV OSD or return to the previous layer.

12. **R/G/Y/B (Colour Button)**

Press to select the pictures with various colours of text. Different channels display different functions.

13. **SIZE**

Press to change the font size: Full screen, Top half, and Bottom half.

14. **SUBPAGE**

Press to select the subpage when the current page contains subpage(s).

15. **REVEAL**

Reveal hidden information such as answers to a quiz.

16. **FREEZE**

Press to freeze a moving image on the screen (only available when your input source is TV).

The SCART output signal will also be frozen when you are watching digital channels.

Caution: Do not freeze the video image for long periods of time, as this may damage the LCD TV screen.

17. **⏮ (INPUT SOURCE)**

Press to select an input source.

18. **EPG**

Press to display electronic programme guide when watching digital channels.

19. **PR LIST**

Press to display channel list.

20. **DTV/ATV**

This key is invalid on this model.

21. **⏮ (View Mode)**

Press to select picture formats: **Auto / 16:9 / 14:9 / Full Screen / 4:3 / Zoom1 / Zoom2 / Zoom3**.

22. **⏮ (+/-)**

Press to adjust the volume.

23. **AUDIO (ADJ)**

Press to set the LCD TV to a predefined sound setting: **User / Music / Speech**.

24. **DUAL**

Press to select Audio language for DTV channel.

25. **OK**

Press to activate a setting.

26. **MENU**

Press to activate the LCD TV OSD.

27. **SUBTITLE**

For DTV, press to toggle off / between available subtitle languages.

28. **TELETEXT**

Press to activate Teletext. Press again to activate Teletext with TV. Press again to turn off Teletext.

29. **HOLD**

Press to stop the scrolling of pages. The text decoder stops receiving data.

30. **INDEX**

Press to return to page 100 or the index page; and then press 0 to 9. The teletext page will be numbered and added to the page you select or the secondary item.

31. **In USB mode:**

(You need to programme the setting with remote control to control connected devices.)



Press to skip back to the previous title or track.



Press to stop playback.



Press to start/pause playback.



Press to skip forward to the next title or track.

Using the remote control

Use the remote control unit by pointing it towards the remote control sensor. Objects between the remote control unit and sensor may block proper operation.

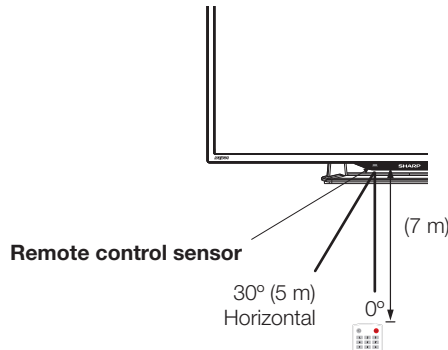

- If you are not going to use the remote control for a long time, remove the batteries to avoid damaging remote control caused by chemical leakage.

Display the Menu Screen

Press **MENU** on the remote control to display the menu screen.

Select an item by the remote control

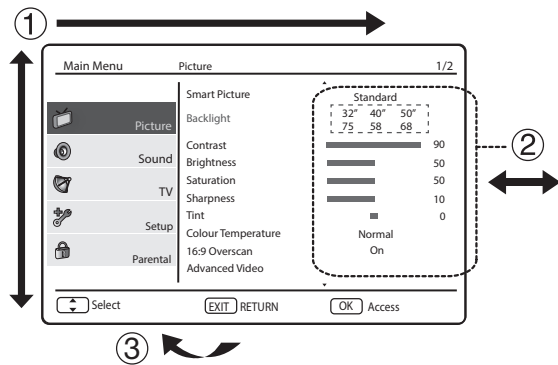

- Press $\wedge \vee >$ to select the desired menu.
- Press $< >$ to select / adjust the item to the desired level. The new setting on the screen is applied immediately.
- Press **EXIT** to return to the previous layer.

Exit the Menu Screen

Press **EXIT** or **Menu** to exit the menu screen.

Run the auto installation

Follow the onscreen instructions to select your preferred **Language**, **Country**, and **Location**.

Daily operation

Turning on/off the power

Turn on the power by pressing the ⏻ button on the TV. Turn off the power by pressing again the ⏻ button on the TV.

Changing channels

Change channels by pressing **P** $\wedge \vee$ button.

Standby mode

To standby mode

If the TV set is switched on, you can switch it to standby mode by pressing ⏻ | button on the remote control.

Switching on from standby

To switch on from standby mode, press ⏻ | button on the remote control.

TV indicator status

⏻ indicator	Status
Off	Power off
Red	Standby
Blue	Power on

NOTE

- If you are not going to use this TV for a long period of time, be sure to remove the AC cord from the power outlet.
- A small amount of electric power is still consumed even when the power is turned off.

Selecting external video source

Once the connection is done, press ⏻ button to display the **Input Selection** screen, and then press $\wedge \vee$ button to switch over to the appropriate external source, and press with **OK** button to confirm.

Preparation and Watching TV

Operation without a remote control

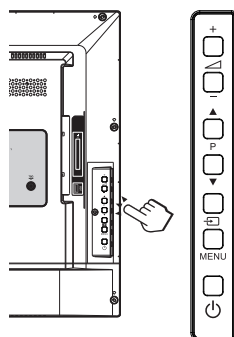

This function is useful when there is no remote control within your reach.

1. Press **MENU** briefly to display the direct control screen.
2. Press **P ▲ ▼** instead of \wedge / \vee , or press $\triangleleft + / -$ instead of $\langle \rangle$, to select the menu option.
3. Press \rightarrow to confirm the selection.

NOTE

- The direct control menu screen will disappear if left unattended for several seconds.

EPG (Electronic Programme Guide)

EPG is an on-screen guide that displays scheduled digital TV programmes. You can navigate, select and view programmes.

NOTE

- The first time you use EPG, you may be prompted to perform an update. If so, follow the on-screen instructions.
1. Press **EPG** on the remote control to display the **EPG** menu.
 2. Use the buttons on the remote control to activate available actions.
 - $\wedge \vee$: Select the channel.
 - $\langle \rangle$: Change the time.
 - **Red** (colour button): List the previous day's EPG.
 - **Green** (colour button): List the next day's EPG.
 3. Press **EPG** or **EXIT** to exit.

Teletext

Turning on and off Teletext

1. Select a TV channel or external source providing a Teletext programme.
2. Press **TELETEXT** to display Teletext.
 - Many stations use the TOP operating system, while some use FLOF (e.g. CNN). Your TV supports both these systems. The pages are divided into topic groups and topics. After switching on the teletext, up to 1000 pages are stored for fast access.
 - If you select a programme with no Teletext signal, "No Teletext" displays.
 - The same message displays during other modes if no Teletext signal is available.
3. Press **TELETEXT** again to activate Teletext with TV.
4. Press **TELETEXT** again to deactivate Teletext.

NOTE

- Teletext will not work if the selected signal type is RGB.

Buttons for teletext operations

Buttons	Description
P (\wedge / \vee)	Increase or decrease the page number.
Colour (R/G/Y/B)	Select a group or block of pages displayed in the coloured brackets at the bottom of the screen by pressing the corresponding Colour (R/G/Y/B) on the remote control unit.
0 - 9	Directly select any page from 100 to 899 by using 0 - 9 .
SIZE	Switch the Teletext image to Top, Bottom or Full.
INDEX	Press this button to return to page 100 or index page.
HOLD	Stop updating Teletext pages automatically or release the hold mode.
REVEAL	Reveal or hide hidden information such as an answer to a quiz.
SUBPAGE	Select the subpage when the current page contains subpage(s). Press number buttons on the remote control to access the subpage directly. (two digits)

Using the MHEG5 application

Some services bring you programmes with the MHEG (Multimedia and Hypermedia Expert Group) application encoded, letting you experience DTV interactively.

When provided, the MHEG5 application will start when you press the **Red** button or **TELETEXT** on the remote control.

Picture

Adjust picture settings

- **Backlight:** Change the level of backlight intensity.
- **Contrast:** Change the level of bright parts in the video but keep the dark parts unchanged.
- **Brightness:** Change the level of light in the video.
- **Saturation:** Change the level of saturation.
- **Sharpness:** Change the level of sharpness of fine details.
- **Tint:** Change the colours to reddish or greenish.
- **Colour Temperature:** Set the colour temperature to **Cool** (bluer), **Normal** (balanced), **Warm** (redder).
- **16:9 Overscan:** When set to **"On"**, enlarge the image to hide the edge of the image.
- **Advanced Video:**
 - * **Digital Noise Reduction:** Filter and reduce the noise in the video.
 - * **Active Contrast:** Dynamically improve the details of contrast in the video.
 - * **Gamma Adjustment:** Change the tones between bright parts and dark parts.
 - * **Adaptive Backlight:** Automatically optimize the backlighting levels for dark scenes.

Use Smart Picture

Apart from manually adjusting picture settings, you can use **Smart Picture** to set your TV to a predefined picture setting.

- **Dynamic**
- **Standard**
- **Movie**
- **Power Saver**

Reset to Defaults

When you activate the **Reset to Defaults**, the TV enters to first time installation.

Sound

Adjust sound settings

- **Bass:** Adjust the amount of bass.
- **Treble:** Adjust the amount of treble.
- **Equalizer:** Adjust the frequency level to suit your favourite sound quality.
- **Balance:** Set the balance of the left and right speakers to best fit your listening position.
- **Headphone Volume:** Adjust the volume of headphone.
- **Sound Surround:** Automatically switch the TV to the best surround sound mode available from a broadcast.

- **Audio CH:** Select the audio mode.
- **Digital Output Type:** Select the type of digital audio out.
- **HDMI 1 Input:** Select to fit the input signal.
- **HDMI 2 Input:** Select to fit the input signal.
- **Auto Volume Control:** Reduce sudden volume changes, for example, during commercials or when switching from one channel to another.
- **Type:** Select the type of audio broadcast.
 - * **Normal:** Set regular audio only.
 - * **Hearing Impaired:** Provides aids in understanding and enjoyment with subtitles (depending on the broadcaster).
 - * **Visually Impaired:** Set the mix of visually impaired audio with regular audio.
- **Visually Impaired:** Adjust the output of visually impaired audio.
 - * **Speaker**
 - * **Headphone**
 - * **Volume:** Adjust the volume of outputs.
 - * **Pan and Fade:** Control the level of the main audio and the pan of the associated audio.

NOTE

- **Bass/Treble:** not available in **User mode(Sound Mode)**.
- **Equalizer:** available only in **User mode(Sound Mode)**.
- **HDMI1 Input/HDMI2 Input:** available only when HDMI is select.

Use Sound Mode

Apart from manually adjusting sound settings, you can use **Sound Mode** to set your TV to a predefined sound setting.

- **User**
- **Music**
- **Speech**

Reset to Defaults

When you activate the **Reset to Defaults**, the TV enters to first time installation.

TV

This chapter provides instructions on how to reinstall channels as well as other useful channel installation features.

Select **Tuning Mode > Access** to enter.

● Select a digital audio language

Select **1st Audio** or **2nd Audio**.

NOTE

- If your selected audio language is not broadcasted, the default audio language will be displayed.

TV menu

● Auto CH Search

Your TV searches and stores all available digital TV channels as well as all available digital radio channels.

● Update CH

Update CH has similar function with **Auto CH Search**. The difference is you can update channel list without erasing the original information.

● DVB-T Single RF Scan

Antenna:

Highlight the **RF Channel** box, select a channel number you prefer to scan.

● Favourites CH

You can create a list of favourite channels.

● CH Skip

Allows you to skip one or more channels .

NOTE

- To watch the skipped channels, enter the channel numbers by using the **digit buttons** on the remote control or select from **PR LIST**.

● CH Sort

Channel sort allows you to reorder the channels in the **PR LIST**.

● CH Edit

Allows you to change the channel number or the channel name.

- **Channel:** Enter a new channel by using the **digit buttons** on the remote control.
- **Channel Name:** Press the **digit buttons** on the remote control to rename the channel.

NOTE

- The new channel number you have entered can not override the exist one.

● Clean CH List

Select to clean all the channels that stored in the channel list.

Setup

Language

Select the menu display language.

View Mode

Change the video format to suit your content.

Time Setup

Set the current time and the sleep timer.

- Set **Time**
- Set **Sleep Timer**

Sleep Timer switches the TV to standby after a defined period of time.

NOTE

- When you press any button on the remote control with less than **3** minutes left in the countdown, **Sleep Timer** will be automatically canceled.

Subtitle Setup

You can enable subtitles for each TV channel.

Subtitles are broadcasted via teletext or DVB-T digital broadcasts. With digital broadcasts, you have the additional option of selecting a preferred subtitle language.

When watching channels with hearing impaired service, you can enable the subtitle commentary for the hearing handicapped. For digital channels only.

NOTE

- If your selected subtitle language is not broadcast, the default language subtitle will be displayed.
- If the **1st Subtitle** language you selected is not available, the **2nd Subtitle** language will be displayed.

Teletext Setup

You can select Teletext language when the TV receives Teletext signals broadcast by a TV network.

Common Interface

This function enables you to watch encrypted services (pay services). (See page.11)

NOTE

- This functions may not work depending upon the country broadcasting circumstances.

Network

● Interaction CH

This function provides an extension of broadcast interactive services via broadcast transmission or IP connection.

● MHEG PIN Protection

Ask the viewer to enter the PIN to allow presentation.

● Internet Connection

When set to "**On**", enable network settings.

● Information

Display information of network connection.

● IP Setup

- Address Type

Select **Auto** to detect IP automatically, or select **Manual** to enter **IP Address**, **Netmask**, **Gateway**, **Primary DNS**, and **Secondary DNS**.

- * **IP Address**
- * **Netmask**
- * **Gateway**
- * **Primary DNS**
- * **Secondary DNS**

● Connection Test

Check if the TV connects to network successfully or not.

OAD (Manual Software Download)

When you get the software updating news from the retailer or internet, you can update the operation software using the **OAD** (Over Air Download). The updated software data will be transferred through the TV signal.

NOTE

- Please do not switch off the TV during the downloading process.

Power Control

You can use this function to save energy.

● Audio Only

When set to **"On"**, you can turn the screen off and enjoy audio only.

● Power Saving

When set to **"On"**, the TV will decrease the power consumption and increase the backlight lifespan.

● No Operation To Sleep

Allows the TV to automatically enter standby mode when there is no operation. Select the time to **1 Hour / 2 Hours / 4 Hours**. Or select **Off** to disable this function.

NOTE

- **5** minutes before the TV enters standby mode, the remaining time is displayed every minute.

CEC Setup

This function enables you to control the HDMI-CEC compliant device connected via the HDMI connector.

Location

Select **Store** or **Home**. Store mode is recommended

for displaying in a retail showroom, and Home mode is recommended for normal home using for energy saving.

Input Labels

You can label each input source (except **USB**) with a custom description.

Icon Light Up Setting

When set to **"On"**, the LED on the front of the TV turns on.

Version Info

Displays the Software information.

Reset

When you activate the **Reset**, the TV enters to first time installation.

Parental

Lock TV channels or connected devices with a four-digit code to prevent children from watching unauthorized content.

You have to enter a 4-digit password every time to access **Parental** menu.

Enter **"5351"** as the default password.

CH Block

Lock TV channels to prevent children from watching certain channels.

NOTE

- If you switch to the locked channel, you will be prompted to enter your password. (If your password is correct, the locked channel will be unlocked before the TV restarts from standby.)

Age Rating

Some digital broadcasters rate their programmes according to age. You can set TV to display only programmes with age ratings higher than your child's.

Change password

Enter your new password in the **New Password** box by using the **digit buttons** on the remote control. Then, enter your new password again in the **Confirm Password** box.

Clear all parental settings

Reset all the settings in the **Parental** menu.

Connecting a USB device or external devices

USB function

This TV is equipped with a USB1.1 and USB2.0 compatible connector that enables you to view photos, listen to music, and play videos stored on a USB storage device.

NOTE



- Depending on the USB device, the TV may not be able to recognise the contained data.
- Use only alphanumeric characters for naming files.
- File names over 80 characters (may vary depending on character set) may not be displayed.
- Do not disconnect a USB device or memory card from the TV while transferring files, using the slide show function, when a screen is switching to another or before you exit "USB" from the "Input List" menu.
- Do not connect and disconnect a USB device from the TV repeatedly.

Basic Operation

1. Turn on the TV.
2. Connect the USB storage device to the USB port on the side of your TV.
3. Press  on the remote control and press $\wedge \vee$ to select **USB** input source and press **OK**. The USB menu appears.
4. Press $\langle \rangle$ to select **Photo**, **Music**, or **Video** and press **OK**. The USB thumbnail browser appears.
5. Press $\wedge \vee \langle \rangle$ and **OK** to browse the files or folders. Press **EXIT** to return to the previous operation / folder.
6. In the thumbnail browser, press $\wedge \vee \langle \rangle$ to select a photo, a music or a video.
7. Press **OK** to view the image, play the MP3, or play the video.
8. Use the buttons on the remote control and follow the on-screen instructions.

View Photos

Buttons for enlarged photo display operation:

Buttons	Descriptions
	Play or pause the slide show.
	Go to the previous/next photo in the same directory.
MENU	Open the Photo sub-menu.
Blue button	Rotate the photo.
EXIT	Return to the previous operation.



Press **Menu** to access **Slideshow Settings**.

NOTE

- **Blue button:** available only in pause mode.

Listen to Music



Buttons for music mode:

Buttons	Descriptions
\rangle (Cursor)	Fast forward the music.
\langle (Cursor)	Rewind the music.
	Play or pause the music.
	Stop the music.
	Go to the previous/next music.
MENU	Open the music sub-menu.
EXIT	Return to the previous operation.
Blue button	Audio only.

Press **Menu** to access **Music Setup Menu**.

Play Videos

Buttons for playing video mode:

Buttons	Descriptions
\rangle (Cursor)	Fast forward the video.
\langle (Cursor)	Reverse the video.
	Play or pause the video.
	Stop the video.
	Go to the previous/next chapter.
MENU	Open the video sub-menu
EXIT	Return to the previous operation.

Press **Menu** to access **Video Setup Menu**.

USB device compatibility

USB 2.0 device	USB Memory, USB card reader, HDD (Mass Storage class)
File system	FAT32 / NTFS
Photo file format	JPEG (*.jpg), PNG
Music file format	MPEG1 (*.MP3) Bitrate: 32k, 64k, 96k, 128k, 196k, 256k, 320kbps Sampling frequency: 32k, 44.1k, 48kHz
Video file format	MPEG1/2 (*.AVI, *.MPG, *.MPEG, *.TS) MPEG4 (*.AVI, *.MP4, *.MOV, *.MKV) H.264 (*.AVI, *.MP4, *.MOV, *.MKV, *.TS) XviD (*.AVI)

NOTE

- Progressive format jpeg files are not supported.
- All files in a USB device with capacity may not be played properly.
- Operation using USB hubs is not guaranteed.

Connecting a USB device or external devices

- Cables used to extend the USB device must be certified as USB 2.0.
- Video playback via a USB device may not be possible or the playback quality affected if the device data transfer speed rating is too low.
- File number over 1000 may not be displayed.
- No quickly operation between play / pause / fast forward / rewind.
- The video might get judder or unsmooth when USB read/write speed is under requirement(some Full HD format).
- Files in USB 1.1 devices may not be played properly.
- Some video file formats may not be played depending on the file.

Inserting the Smartcard into CA module

In order to receive coded digital stations, a Conditional Access module (CA module) and a Smartcard must be inserted into the CI (Common Interface) slot of the TV.

The CA module and the Smartcard are not supplied accessories. They are usually available from your dealer.

Inserting the Smartcard into the CA module

1. Carefully insert the CA module into the CI slot with the contact-side forward.
2. The logo on the CA module must be facing outward from the rear of the TV.

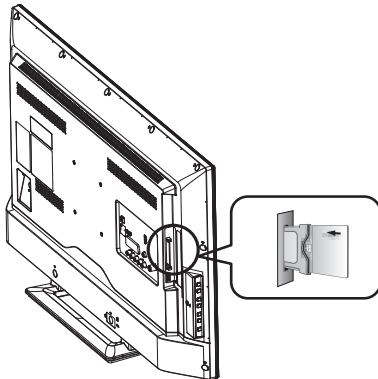

NOTE

- It takes about 30 seconds to certify the license key when you insert a Smartcard into the CI+ compatible CA module for the first time. This process may fail when there is no antenna input or you have never run "Auto installation".
- The CI+ compatible CA module sometimes upgrades its firmware. You may not receive any TV images before upgrading. You can only use the power button during upgrading.
- The CI+ compatible CA module does not allow you to output any copy protected programmes using monitor out.
- If the TV displays an update confirmation message for the Smartcard while receiving CI+ compatible broadcasts, follow the screen prompts.
- Make sure that the CA module is properly inserted.

Checking CA module information

After inserting and activating the CA module, make sure the input source is **TV**.

NOTE

- This menu is only available for digital stations.
- The content of this menu depends on the provider of the CA module.

Module: General information on CA module displays.

Menu: Adjustment parameters of each Smartcard displays.

Enquiry: You can input numerical values such as passwords here.

HDMI connection

System Standby

- When set to "On", turning off the TV will automatically turn off the connected HDMI-CEC compliant device .

Audio return channel (ARC)

The TV can send audio data for video content shown on the TV to a connected audio device with just one ARC-compatible HDMI cable. Using this function eliminates the need to use a separate digital or analogue audio cable.

Connection for using "Audio return channel"

- You need to use ARC-compatible cables/devices and connect to the **HDMI 1** terminal to activate this function.

Supported display resolutions

Computer formats (PC)

Resolution	Refresh rate
640 x 480	60Hz
800 x 600	60Hz
1024 x 768	60Hz
1280 x 768	60Hz
1360 x 768	60Hz
1280 x 1024	60Hz

Video formats

Resolution	Refresh rate
480i	60Hz
480p	60Hz
576i	50Hz
576p	50Hz
720p	50Hz, 60Hz
1080i	50Hz, 60Hz
1080p	(HDMI only) 50Hz, 60Hz, 24Hz

Appendix

Troubleshooting

Problem	Possible Solution
No picture	<ol style="list-style-type: none"> 1. Connect power cord correctly. 2. Turn on power. 3. Connect signal cable correctly. 4. Press any button on the LCD TV.
Abnormal colours	Connect signal cable correctly.
Twisted picture	<ol style="list-style-type: none"> 1. Connect signal cable correctly. 2. Please use compatible signal.
Picture too dark	Adjust brightness and contrast.
Audio only, no images	<ol style="list-style-type: none"> 1. Please check if input signal is connected correctly. 2. TV-RF signal must not be lower than 50dB.
Picture only, no audio	<ol style="list-style-type: none"> 1. Connect signal cable correctly. 2. Adjust volume to proper level. 3. Connect audio signal cable correctly. 4. TV-RF signal must not be lower than 50dB.
Cannot use remote control	<ol style="list-style-type: none"> 1. Please change battery. 2. Turn off power for 10 seconds; and then restart power.
Cannot receive sufficient channels through antenna	Please use the Channel Scan function to increase the number of channels not included in memory.
No colour	Please adjust the colour setup.
Blinking picture accompanied by ghost image	<ol style="list-style-type: none"> 1. Check the connection of antenna/signal cable. 2. Check if channel is in play mode. 3. Press signal source and change input mode.
Broken lines or segments	Adjust antenna. Keep the TV away from noise sources, such as automobiles, neon lights, and hair dryers.
Certain TV channels are blocked (Hope to acquire some channels)	Please use the Update Scan method to add the channels not included in memory.
Overlapping images or ghost images	Please use multi-directional outdoor antenna. (If your TV is subject to the influence of nearby mountains or buildings).
Cannot use a function	If the item you choose turns gray, that item cannot be selected.
Cannot receive programmes	Please use the Update Scan method to add the channels not included in memory.

Environmental specifications

A	Product Fiche			
B	Commercial Brand: SHARP			
C	Product.	LCD TV		
D	Model name	LC-32LD171K	LC-40LD271K	LC-50LD271K
E	Energy Efficiency Class	Class A+	Class A+	Class A+
F	Visible screen size(diagonal aprox)(inch/cm)	32" / 80 cm	40" / 101 cm	50" / 127 cm
G	On mode average power consumption(Watt)*	31W	46W	71W
H	Annual energy consumption(kWh/annum)**	45kWh	67kWh	104kWh
I	Standby power consumption(Watt)	0.26W	0.27W	0.27W
G	Off mode power consumption(Watt)	N/A	N/A	N/A
K	Display resolution(Pixels)	1366 x 768	1920 x 1080	1920 x 1080

NOTE

** - Energy consumption XYZ kWh per year, based on the power consumption of the television operating 4 hours per day for 365 days. The actual energy consumption will depend on how the television is used.

* - when the TV is turned off with the remote control and no function is active

Specification

Item		32" LCD COLOUR TV Model: LC-32LD171K	40" LCD COLOUR TV Model: LC-40LD271K	50" LCD COLOUR TV Model: LC-50LD271K
LCD screen size (diagonal)		32" / 80 cm	40" / 101 cm	50" / 127 cm
Number of dots		3,147,264 dots (1366 x 768 x 3 dots)	6,220,800 dots (1920 x 1080 x 3 dots)	
Video Colour System		PAL/SECAM/NTSC 3.58/NTSC 4.43/PAL 60		
TV Function	TV-Standard	Digital	DVB-T, DVB-T2	
	Receiving Channel	VHF/UHF	DVB-T: E5-E69	
	TV-Tuning System		Auto Preset 1599 ch, Auto Label, Auto Sort	
Audio amplifier		5 W x 2	8 W x 2	
Speaker (mm)		132(H) x 34(W) x 36.5(D)		
Rear	ANTENNA	UHF/VHF 75 Ω		
	SCART	SCART (AV input, Y/C input, RGB input, TV output)		
	ETHERNET	Network connector		
	CVBS/COMPONENT	CVBS/Y/Pb(Cb)/Pr(Cr), RCA pin (L/R)		
	Digital Audio out	Optical Digital audio output x 1 (PCM)		
	HDMI 1	Digital video and audio input, ARC		
	HDMI 2	Digital video and audio input		
	HEADPHONE	Ø 3.5mm jack (Audio output)		
Side	C. I. (Common Interface)	EN50221, R206001, CI Plus specification		
	USB	Software update, multi-media play		
OSD Language		English, German, French, Italian, Dutch, Spanish, Greek, Portuguese, Swedish, Finnish, Russian, Polish, Turkish, Hungarian, Czech, Slovak, Danish, Norwegian, Estonian, Latvian, Lithuanian, Slovenian, Bulgarian, Croatian, Romanian, Serbian, Ukrainian		
Power Requirement		AC 220–240 V, 50 Hz		
Power Consumption (IEC60065)		50 W	75 W	110 W
Standby Consumption		< 0.3W	< 0.3W	< 0.3W
Weight	Without stand	4.63 kg	7.6 kg	12.7 kg
	With stand	5.02 kg	8.2 kg	13.5 kg
Operating temperature		0°C to +40°C		

- As a part of policy of continuous improvement, SHARP reserves the right to make design and specification changes for product improvement without prior notice. The performance specification figures indicated are nominal values of production units. There may be some deviations from these values in individual units.

NOTE

- 32" Unit without base weight=4.63 kg The equipment and its associated mounting means still remain secure during the test. (Used wall mounting kit, 100 x 100 mm distance, diameter of Screw dimension: M4 x 18) or equivalent.
- 40" Unit without base weight=7.6 kg The equipment and its associated mounting means still remain secure during the test. (Used wall mounting kit, 200 x 200 mm distance, diameter of Screw dimension: M4 x 18) or equivalent.
- 50" Unit without base weight=12.7 kg The equipment and its associated mounting means still remain secure during the test. (Used wall mounting kit, 400 x 200 mm distance, diameter of Screw dimension: M6 x 18) or equivalent.
- Refer to the inside back cover for dimensional drawings.
- Audio cannot be output through the HDMI terminal.

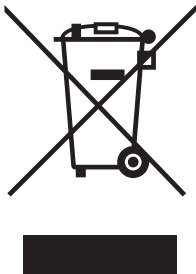

Attention:

Your product is marked with this symbol. It means that used electrical and electronic products should not be mixed with general household waste. There is a separate collection system for these products.

A. Information on Disposal for Users (private households)

1. In the European Union

Attention: If you want to dispose of this equipment, please do not use the ordinary dust bin!

Used electrical and electronic equipment must be treated separately and in accordance with legislation that requires proper treatment, recovery and recycling of used electrical and electronic equipment.

Following the implementation by member states, private households within the EU states may return their used electrical and electronic equipment to designated collection facilities free of charge*. In some countries* your local retailer may also take back your old product free of charge if you purchase a similar new one.

*) Please contact your local authority for further details.

If your used electrical or electronic equipment has batteries or accumulators, please dispose of these separately beforehand according to local requirements.

By disposing of this product correctly you will help ensure that the waste undergoes the necessary treatment, recovery and recycling and thus prevent potential negative effects on the environment and human health which could otherwise arise due to inappropriate waste handling.

2. In other Countries outside the EU

If you wish to discard this product, please contact your local authorities and ask for the correct method of disposal.

For **Switzerland:** Used electrical or electronic equipment can be returned free of charge to the dealer, even if you don't purchase a new product. Further collection facilities are listed on the homepage of www.swico.ch or www.sens.ch.

B. Information on Disposal for Business Users

1. In the European Union

If the product is used for business purposes and you want to discard it:

Please contact your SHARP dealer who will inform you about the take-back of the product. You might be charged for the costs arising from take-back and recycling. Small products (and small amounts) might be taken back by your local collection facilities.

For **Spain:** Please contact the established collection system or your local authority for take-back of your used products.

2. In other Countries outside the EU

If you wish to discard of this product, please contact your local authorities and ask for the correct method of disposal.



For **EU:** The crossed-out wheeled bin implies that used batteries should not be put to the general household waste! There is a separate collection system for used batteries, to allow proper treatment and recycling in accordance with legislation.

Please contact your local authority for details on the collection and recycling schemes.

For **Switzerland:** The used battery is to be returned to the selling point.

For other **non-EU countries:** Please contact your local authority for correct method of disposal of the used battery.

SHARP®

SHARP CORPORATION
<http://www.sharp.eu>



PIN

--	--	--	--

Printed in Poland

SHA/MAN/000G



X41G32MV84307A