

# Panasonic®

## Operating Instructions Home Theater Audio System

Model No. SC-HTB485



Thank you for purchasing this product.  
Please read these instructions carefully before using this product,  
and save this manual for future use.

### Included Installation Instructions

**The installation work should be done by a qualified installation specialist. (⇒ 13 to 18)**

Before commencing work, carefully read these installation instructions and the operating instructions to ensure that installation is performed correctly.

(Please keep these instructions. You may need them when maintaining or moving this system.)

Model number suffix “EB” denotes UK model.

EG EB GN

RQT0A04-B

# Safety precautions

## WARNING

### Unit

- To reduce the risk of fire, electric shock or product damage,
  - Do not expose this unit to rain, moisture, dripping or splashing.
  - Do not place objects filled with liquids, such as vases, on this unit.
  - Use only the recommended accessories.
  - Do not remove covers.
  - Do not repair this unit by yourself. Refer servicing to qualified service personnel.
- To prevent injury, this apparatus must be securely attached to the wall in accordance with the installation instructions.

### AC mains lead

- To reduce the risk of fire, electric shock or product damage,
  - Ensure that the power supply voltage corresponds to the voltage printed on this unit.
  - Insert the mains plug fully into the socket outlet.
  - Do not pull, bend, or place heavy items on the lead.
  - Do not handle the plug with wet hands.
  - Hold onto the mains plug body when disconnecting the plug.
  - Do not use a damaged mains plug or socket outlet.
- The mains plug is the disconnecting device. Install this unit so that the mains plug can be unplugged from the socket outlet immediately.

### Button-type battery (Lithium battery)

- Risk of fire, explosion and burns. Do not recharge, disassemble, heat above 60 °C or incinerate.
- Keep the Button-Type battery out of the reach of children. Never put Button-Type battery in mouth. If swallowed call your doctor.

### Small object

- Keep the screws out of reach of children to prevent swallowing.
- Keep the adhesive tape out of reach of children to prevent swallowing.
- Keep the button-type battery out of reach of children to prevent swallowing.

## CAUTION

### Unit

- Do not place sources of naked flames, such as lighted candles, on this unit.
- This unit may receive radio interference caused by mobile telephones during use. If such interference occurs, please increase separation between this unit and the mobile telephone.
- This unit is intended for use in moderate climates.
- Product Identification Marking is located on the bottom of the unit.

### Placement

- Place this unit on an even surface.
- To reduce the risk of fire, electric shock or product damage,
  - Do not install or place this unit in a bookcase, built-in cabinet or in another confined space. Ensure this unit is well ventilated.
  - Do not obstruct this unit's ventilation openings with newspapers, tablecloths, curtains, and similar items.
  - Do not expose this unit to direct sunlight, high temperatures, high humidity, and excessive vibration.

### Button-type battery (Lithium battery)

- Danger of explosion if battery is incorrectly replaced. Replace only with the type recommended by the manufacturer.
- Insert with poles aligned.
- Mishandling of batteries can cause electrolyte leakage and may cause a fire.
  - Remove the battery if you do not intend to use the remote control for a long period of time. Store in a cool, dark place.
  - Do not heat or expose to flame.
  - Do not leave the battery(ies) in a car exposed to direct sunlight for a long period of time with doors and windows closed.
- When disposing of the batteries, please contact your local authorities or dealer and ask for the correct method of disposal.

# Caution for AC Mains Lead

## (For the AC mains plug of three pins)

For your safety, please read the following text carefully.

This appliance is supplied with a moulded three pin mains plug for your safety and convenience. A 5-ampere fuse is fitted in this plug.

Should the fuse need to be replaced please ensure that the replacement fuse has a rating of 5-ampere and that it is approved by ASTA or BSI to BS1362.

Check for the ASTA mark  or the BSI mark  on the body of the fuse.

If the plug contains a removable fuse cover you must ensure that it is refitted when the fuse is replaced.

If you lose the fuse cover the plug must not be used until a replacement cover is obtained.

A replacement fuse cover can be purchased from your local dealer.

### Before use

Remove the connector cover.

### How to replace the fuse

The location of the fuse differ according to the type of AC mains plug (figures A and B). Confirm the AC mains plug fitted and follow the instructions below.

Illustrations may differ from actual AC mains plug.

1. Open the fuse cover with a screwdriver.

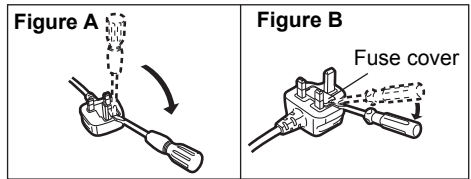

2. Replace the fuse and close or attach the fuse cover.

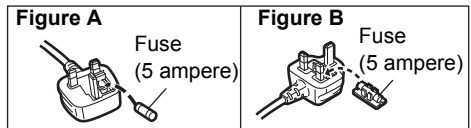

# Table of contents

Safety precautions.....	2
Caution for AC Mains Lead.....	3

## Before use

---

---

Supplied items .....	5
This system (SC-HTB485) .....	5
Accessories .....	5
Control reference guide .....	6
This system (Front) .....	6
This system (Rear) .....	7
Remote control .....	8

## Getting started

---

---

Step 1 Connections .....	9
Connection with the TV .....	9
Connection from an HDMI compatible device .....	10
Connection to a 4K Ultra HD TV .....	11
Using the IR Blaster .....	11
AC mains lead connection .....	12
Step 2 Placement .....	13
Safety Precautions .....	13
The active subwoofer .....	13
Wireless interference .....	13
Selecting the placement method .....	14
When placing the main unit in a rack or on a table .....	15
When attaching the main unit to a wall .....	16
Step 3 Wireless connections .....	19
Active subwoofer wireless connection .....	19
Bluetooth® connection .....	19
Remote control code .....	20

## Operations

---

---

Using this system .....	21
3D sound .....	22
Sound menu .....	22
Audio format .....	23
Setup menu .....	24
Linked operations with the TV (VIERA Link “HDAVI Control™”) .....	25

## Reference

---

---

Troubleshooting .....	26
About Bluetooth® .....	29
Unit care .....	29
Licenses .....	29
Specifications .....	30
Limited Warranty (ONLY FOR AUSTRALIA).....	35

- The illustrations shown may differ from your unit.
- Operations in this operating instructions are described mainly with the remote control, but you can perform the operations on the main unit if the controls are the same.





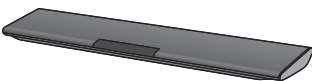
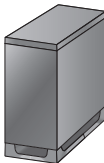

## Supplied items

### This system (SC-HTB485)

<input type="checkbox"/> <b>1 Main unit (speaker)</b> (SU-HTB485) 	<input type="checkbox"/> <b>1 Active subwoofer</b> (SB-HWA480) 
--	--

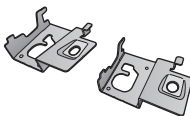
### Accessories

Check the supplied accessories before using this system.

<input type="checkbox"/> <b>1 Remote control (with a battery)</b> (N2QAYC000109) 	<input type="checkbox"/> <b>1 IR Blaster</b> (K2ZZ02C00007) 	<input type="checkbox"/> <b>2 Wall mount brackets</b> (RMQ2281A, RMQ2281B) 
<input type="checkbox"/> <b>2 AC mains leads</b> <div style="display: flex; justify-content: space-around;"> <div data-bbox="39 850 364 1058"> <p>For the United Kingdom and Ireland (K2CT2YY00097)</p>  </div> <div data-bbox="364 850 683 1058"> <p>For Continental Europe (K2CQ2YY00119)</p>  </div> <div data-bbox="683 850 1008 1058"> <p>For Australia and New Zealand (K2CJ2YY00101)</p>  </div> </div>		
<input type="checkbox"/> <b>2 Screws</b> (XYN5+J14FJK) 		



- Product numbers are correct as of December 2014. These may be subject to change.
- The supplied AC mains lead is for use with this system only.  
Do not use it with other equipment. Also, do not use cords from other equipment with this system.

# Control reference guide

## This system (Front)

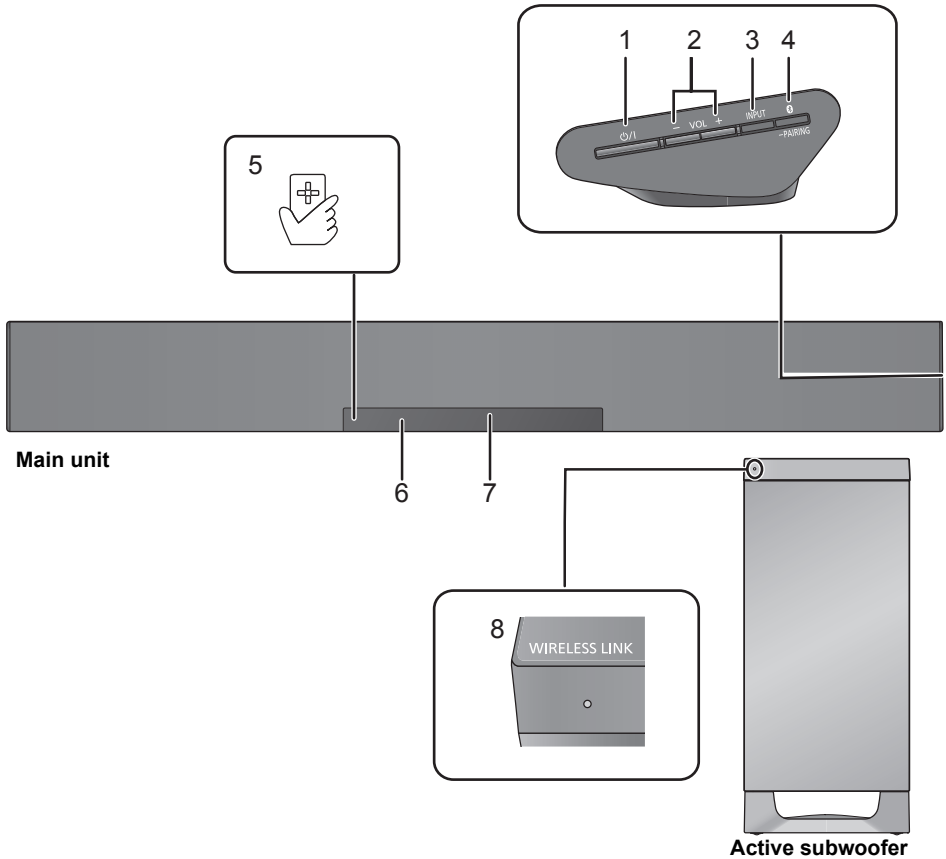

- 1 Standby/on switch (⏻/⏻)**  
Press to switch the unit from on to standby mode or vice versa. In standby mode, the unit is still consuming a small amount of power.
- 2** Adjust the volume of this system (⇒ 21)
- 3** Select the input source (⇒ 21)  
“TV” → “BD/DVD” → “BLUETOOTH”  
↑
- 4** Select the Bluetooth® device as the source (⇒ 21)
- 5** NFC touch area (⇒ 20)
- 6** Remote control signal sensor (⇒ 8)
- 7** Display
- 8** WIRELESS LINK indicator (⇒ 19)

## This system (Rear)

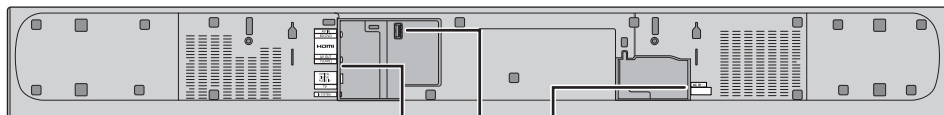

Main unit

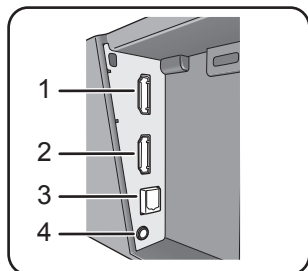

5

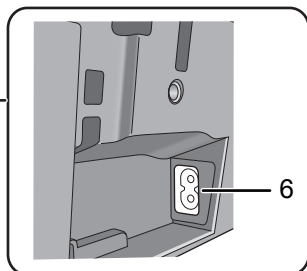

6

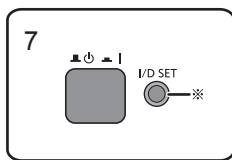

7

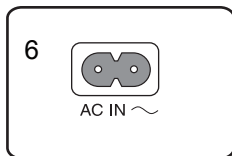

6

Active subwoofer

- |  |   |
|--|---|
| 1 HDMI AV IN (BD/DVD) terminal (⇒ 10)                        | 4 Ir SYSTEM terminal (⇒ 11, 12)         |
| 2 HDMI AV OUT (TV (ARC)) terminal (ARC compatible) (⇒ 9, 10) | 5 USB port (for service use only)       |
| 3 OPTICAL DIGITAL AUDIO IN (TV) terminal (⇒ 10)              | 6 AC IN terminal (⇒ 12)                 |
|  | 7 Active subwoofer on/off button (⇒ 19) |

※ The I/D SET button is only used when the main unit is not paired with the active subwoofer. (⇒ 28)

## Remote control

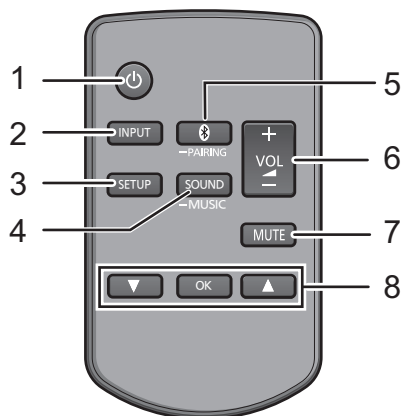

- 1 Turn the main unit on or off (⇒ 21)
- 2 Select the input source (⇒ 21)  
 “TV” → “BD/DVD” → “BLUETOOTH”
- 3 Select the setup menu (⇒ 24)
- 4 Select the sound menu (⇒ 22)
- 5 Select the Bluetooth® device as the source (⇒ 21)
- 6 Adjust the volume of this system (⇒ 21)
- 7 Mute the sound (⇒ 21)
- 8 Select and confirm the option

### ■ Before using for the first time

Remove the insulation sheet **A**.

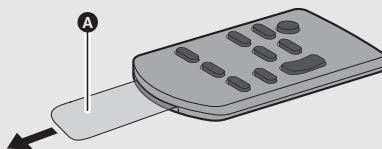

### ■ To replace a button-type battery

Battery type: CR2025 (Lithium battery)

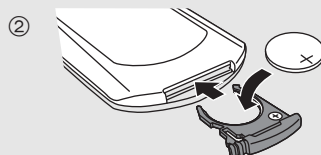
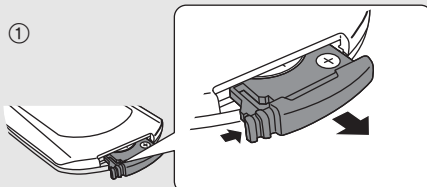

- Set the button-type battery with its (+) mark facing upward.

### ■ About remote control signal sensor

The remote control signal sensor is located on the main unit.

- Use the remote control within the correct operation range.

Distance: Within approx. 7 m directly in front

Angle: Approx. 30° left and right

#### For table top layout

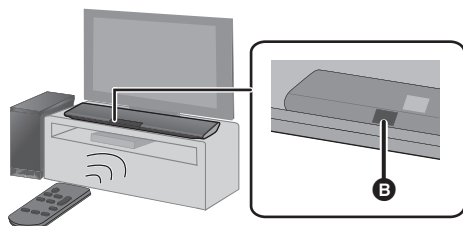

#### For wall mounting layout

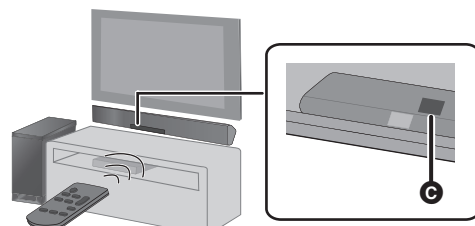

- B** Remote control signal sensor for table top layout
- C** Remote control signal sensor for wall mounting layout



# Step 1 Connections

- Turn off all equipment before connection and read the appropriate operating instructions.
- Do not connect the AC mains lead until all other connections are completed.

## ■ HDMI (High-Definition Multimedia Interface)

- The HDMI connection supports VIERA Link "HDAVI Control" (⇒ 25) when used with a compatible Panasonic TV.
- Use the ARC compatible High Speed HDMI Cables. Non-HDMI-compliant cables cannot be utilised.
- It is recommended that you use Panasonic's HDMI cable.

## ■ IR (Infrared) Blaster

- Do not use the IR Blaster if the TV's remote control sensor is not blocked by the main unit. (⇒ 14)

## Connection with the TV

### 1 Verify if the TV's HDMI terminal is labelled "HDMI (ARC)".

Connection differs depending on the label printed next to the HDMI terminal.

Labelled "HDMI (ARC)": Connection **A**

Not Labelled "HDMI (ARC)": Connection **B**

## ■ What is ARC?

ARC is an abbreviation of Audio Return Channel, also known as HDMI ARC. It refers to one of the HDMI functions. When you connect the main unit to the terminal labelled "HDMI (ARC)" on the TV, the optical digital audio cable that is usually required in order to listen to sound from a TV is no longer required, and TV pictures and sound can be enjoyed with a single HDMI cable.

### 2 Make the connection.

#### **A** Labelled "HDMI (ARC)"

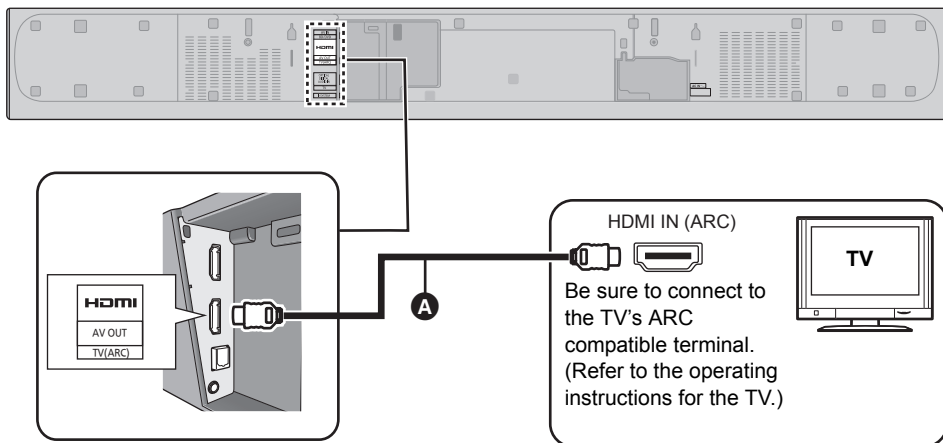

**A** HDMI cable

## **B** Not labelled “HDMI (ARC)”

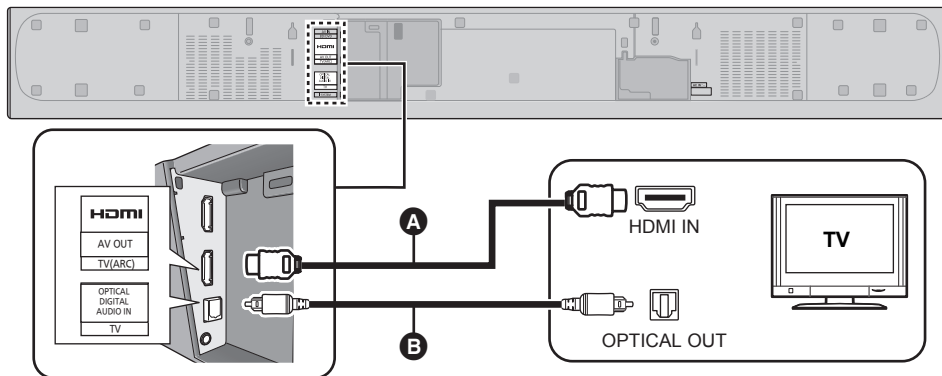

**A** HDMI cable

**B** Optical digital audio cable

- When you use the optical digital audio cable, insert the tip correctly into the terminal.

## **Connection from an HDMI compatible device**

You can direct the audio signal from the connected Blu-ray Disc player, DVD player, Set Top Box, etc. to this system.

### **Preparation**

- Connect the main unit to the TV. (⇒ 9)

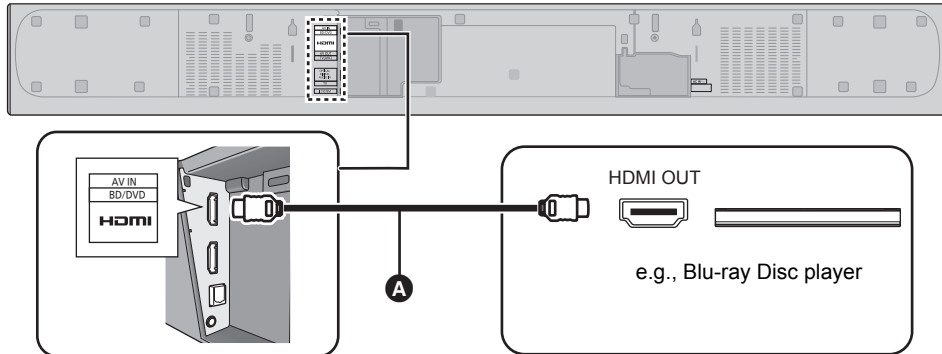

**A** HDMI cable

### **HDMI standby pass-through**

Even if the main unit is in standby mode, the audio and/or video signal from the device connected to the HDMI AV IN terminal will be sent to the TV connected to the HDMI AV OUT terminal (the sound will not be output from this system).

### **3D compatibility**

Compatible with FULL HD 3D TV and Blu-ray Disc player.

- The main unit can pass-through the 3D video signal from a 3D compatible Blu-ray Disc player to a FULL HD 3D TV.



- Refer to the operating instructions of the connected HDMI compatible device for the necessary setting, to output the video and audio signals.

## Connection to a 4K Ultra HD TV

This system cannot pass-through the 4K content of a 4K compatible equipment to a 4K Ultra HD TV. However, you can connect the system to a 4K Ultra HD TV to enjoy the 4K content.

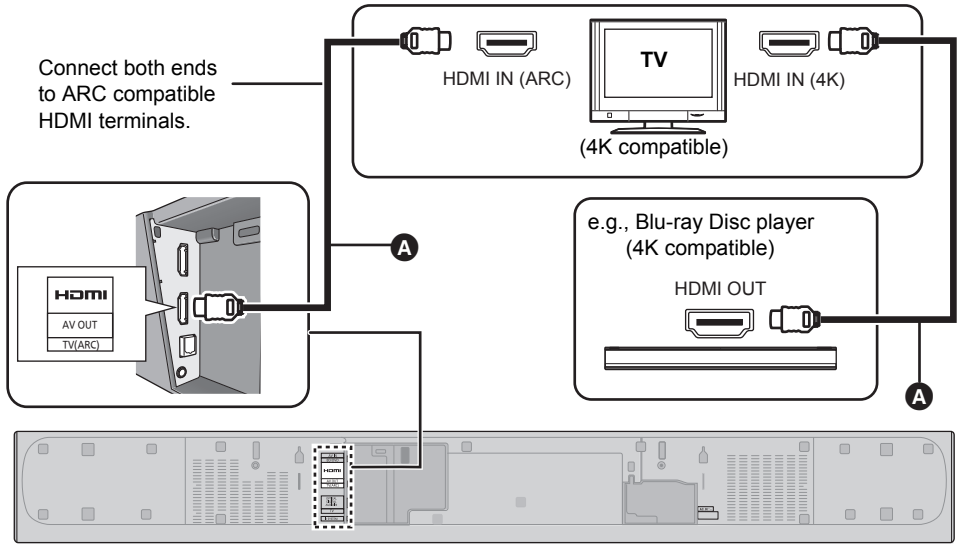

### A HDMI cable



- Refer to the operating instructions of the 4K Ultra HD TV (VIERA) and the 4K/60p compatible equipment for setup and for playing the 4K content.
- To enjoy multi-channel output from this system, set the audio output of other equipment to Bitstream.
- The audio signal input to this system is up to 5.1 channels.

## Using the IR Blaster

With the IR Blaster connection, it is possible to send the IR signal received by this system's remote control signal sensor to the TV's sensor.

**Use the TV's remote control within the operation range of this system's remote control signal sensor.**

- For the operation range, refer to page 8.

### 1 Connect the jack plug to the main unit's Ir SYSTEM terminal.

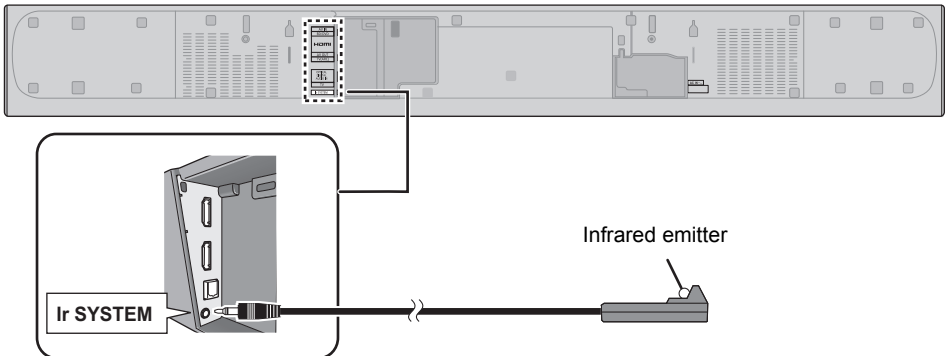

## 2 Place the infrared emitter in sight of the TV's remote control signal sensor.

- For the location of the TV's remote control signal sensor, refer to the operating instructions for the TV.

## 3 Aim the TV's remote control at this system's remote control sensor and operate the TV.

- For the location of this system's remote control signal sensor, refer to page 8.
- Make sure to clean the surface, where the adhesive tape is to be attached.
- If you peel off the adhesive tape, the surface may become damaged and exposed adhesive may remain. Once you have confirmed the TV is operating correctly, secure it by attaching the adhesive tape.



- The supplied IR Blaster is only compatible with Panasonic TVs.

### ■ Placement example

On the rear of the main unit:

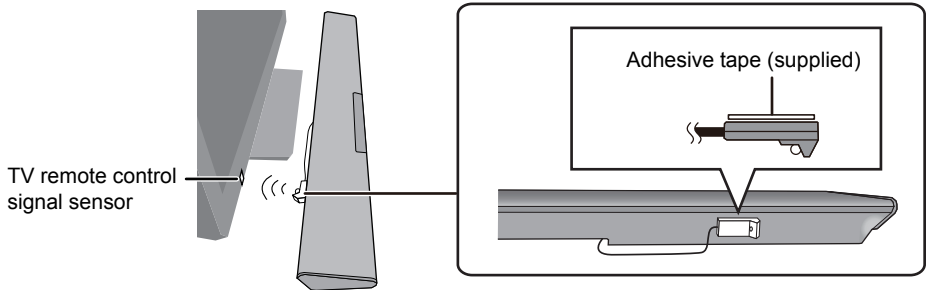

## AC mains lead connection

- Connect only after all other connections are completed.

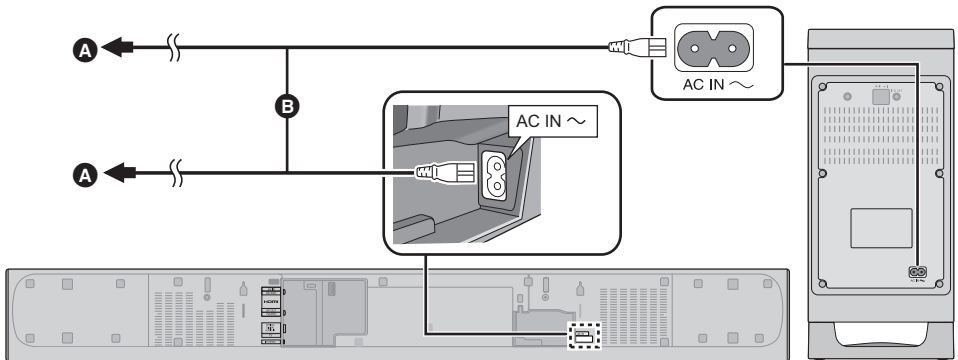

- A** To a household mains socket

- B** AC mains lead (supplied)

- This system consumes a small amount of AC power (⇒ 30) even when it is turned off. In the interest of power conservation, if you will not be using this system for a long time, unplug it from the household mains socket.

### Saving energy

The main unit is designed to conserve its power consumption and save energy.

- The main unit will automatically switch to standby mode when no signal is input and no operation is performed for approx. 20 minutes. Refer to page 24, "AUTO POWER DOWN" to turn this function off.

# Step 2 Placement

## Safety Precautions

Professional installation is required.

The installation should never be done by any other than a qualified installation specialist. PANASONIC DISCLAIMS ANY PROPERTY DAMAGE AND/OR SERIOUS INJURY, INCLUDING DEATH RESULTING FROM IMPROPER INSTALLATION OR INCORRECT HANDLING.

- Be sure to install the main unit as indicated within this operating Instructions.
- Attach using techniques suited to the structure and materials of the installation location.

### Caution

- This system is to be used only as indicated in these instructions. Failure to do so may lead to damage to the amplifier and/or the speaker, and may result in the risk of fire. Consult a qualified service person if damage has occurred or if you experience a sudden change in performance.
- Do not attempt to attach the main unit to a wall using methods other than those described in this manual.



- Do not hold the main unit in one hand to avoid injury, you may drop the main unit when carrying it.
- To prevent damage or scratches, lay down a soft cloth and perform the assembly on it.

## The active subwoofer

When carrying the active subwoofer

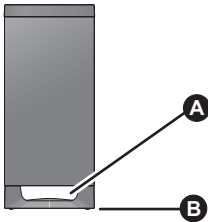

- A** Do not hold the active subwoofer from this opening.  
The parts inside may get damaged.
- B** Always hold the bottom of the active subwoofer when moving it.

## Wireless interference

To avoid interference, maintain the following distances between the main unit/active subwoofer and other electronic devices that use the same radio frequency (2.4 GHz band).

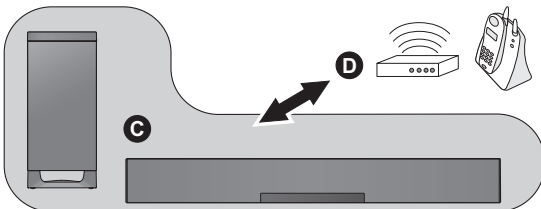

- C** Main unit/active subwoofer
- D** Wireless router, cordless phone and other electronic devices: approx. 2 m

## Selecting the placement method

Choose a placement method that suits you best.

### When placing the main unit in a rack or on a table

- Place the main unit on a flat and horizontal surface.



Page 15

### When attaching the main unit to a wall

- Place the main unit on a flat and vertical surface.



Page 16

### ■ When placing the main unit in front of the TV

The main unit may block or interfere with the TV's various sensors (C.A.T.S. (Contrast Automatic Tracking System) sensor, remote control sensor, etc.) and the 3D Eyewear transmitters on a 3D compatible TV.

- If interference occurs, move the main unit further away from the TV. If the TV still does not function correctly, try using it in a rack or in the wall mount position.

### ■ If the TV's remote control sensor is blocked by the main unit

Try using the TV's remote control from a different angle. If the problem persists, you can use the supplied IR Blaster to relay the signal to the TV. (⇒ 11, 12)



- Place the active subwoofer within a few meters of the main unit and in a horizontal position with the top panel facing upward.
- Do not use the main unit or the active subwoofer in a metal cabinet.
- Placing the active subwoofer too close to the walls and corners can result in excessive bass. Cover walls and windows with thick curtains.
- If irregular colouring occurs on your TV, turn the TV off for about 30 minutes. If it persists, move the main unit and active subwoofer further away from the TV.
- Keep magnetised items away. Magnetised cards, watches, etc., can be damaged if placed too close to the main unit and active subwoofer.

## When placing the main unit in a rack or on a table

### Additionally required accessories (commercially available)

- Fall prevention cord ..... × 2
- Screw eyes (to attach the fall prevention cord) ..... × 2



- Use commercially available screws that are capable of supporting over 26 kg.
- Use a cord that is capable of supporting over 26 kg (with a diameter of about 1.5 mm).

### 1 Attach the cord to the main unit.

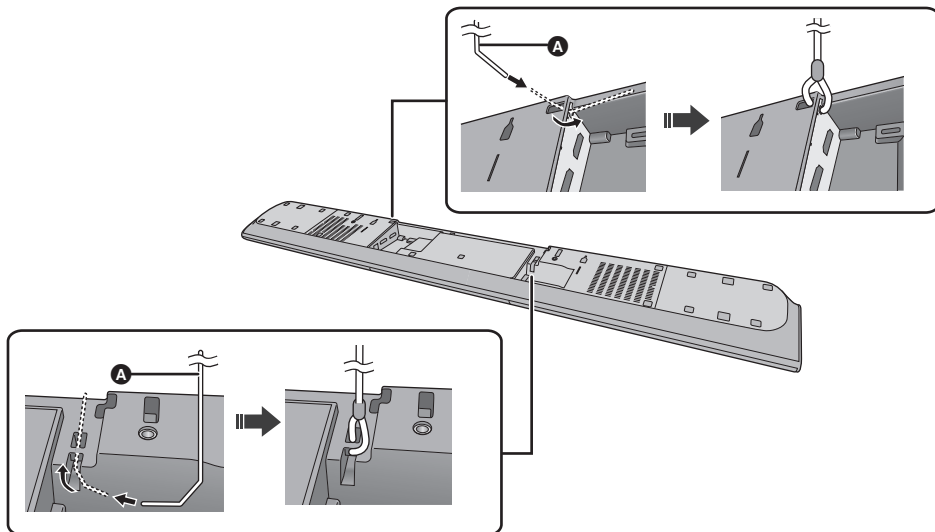

#### A Cord\*

- ※ If the cord cannot be threaded through the holes, try bending the cord in 2 locations, about 5 mm apart from the tip, at an angle of 45° (as illustrated above).

### 2 Place the main unit in the desired position and attach each cord onto the rack or table.

- Make sure that the slack of the cord is minimal.
- Do not lean the main unit against the TV or wall.

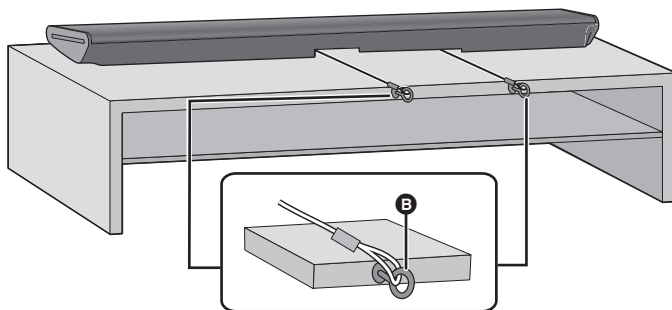

#### B Screw eye

- Attach at a position capable of supporting over 26 kg.
- Depending on the placement of the main unit, the screwing position of the screw eye may differ.

## When attaching the main unit to a wall

The main unit can be wall mounted using the supplied wall mount brackets, etc. Make sure that the screw used and the wall are strong enough to support the weight of at least 26 kg.

The screws and other items are not supplied as the type and size will vary with each installation.

- Refer to step 3 for details about the required screws.
- Be sure to attach the fall prevention cord as a secondary safety measure.

### Supplied accessories

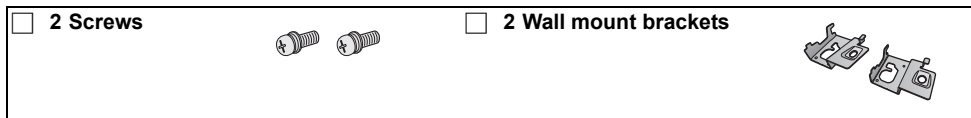

### Additionally required accessories (commercially available)

- |  |     |
|--|-----|
| ● Screws for wall mounting .....                       | × 2 |
| ● Fall prevention cord .....                           | × 2 |
| ● Screw eyes (to attach the fall prevention cord)..... | × 2 |



- Use a cord that is capable of supporting over 26 kg (with a diameter of about 1.5 mm).

## 1 Attach the cord to the main unit.

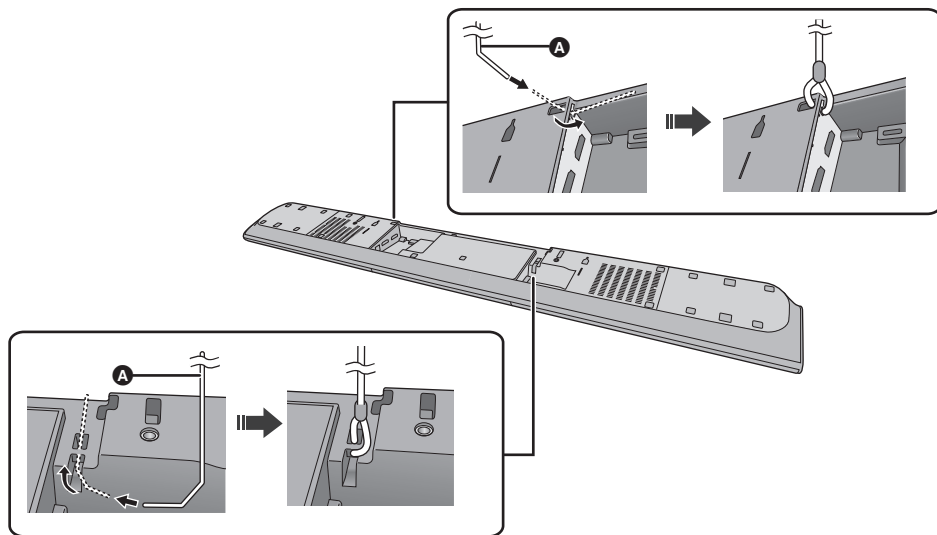

### A Cord\*

- ※ If the cord cannot be threaded through the holes, try bending the cord in 2 locations, about 5 mm apart from the tip, at an angle of 45° (as illustrated above).



## 2 Attach the wall mount brackets to the main unit.

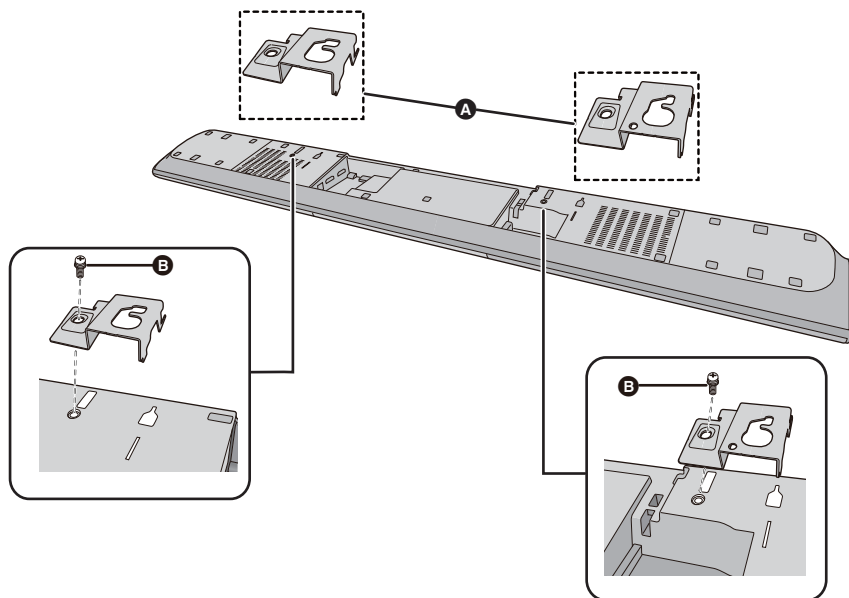

- A** Wall mount bracket (supplied)
- B** Screw (supplied)

## 3 Drive a screw into the wall.

- Use the measurements indicated below to identify the screwing positions on the wall.
- Leave at least 100 mm of space above of the main unit to allow enough space for fitting the main unit.
- Position the main unit with at least 50 mm of free space to its right. If not, it may not be possible to access the buttons.
- Be sure to use a level to ensure that both mounting holes are level to each other.

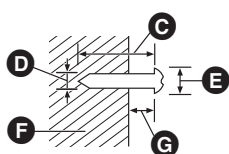

- C** At least 30 mm
- D**  $\varnothing 4.0$  mm
- E**  $\varnothing 7.0$  mm to  $\varnothing 9.4$  mm
- F** Wall or pillar
- G** 1.6 mm to 2.5 mm

### Front view (semi-transparent image)

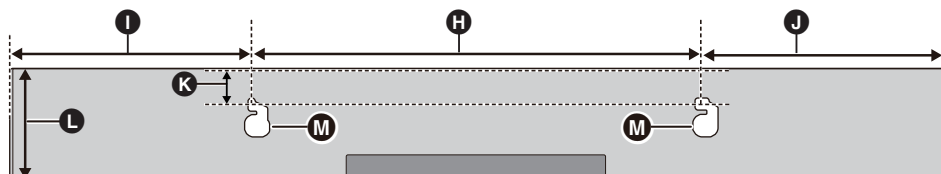

- H** 400 mm
- I** 275 mm
- J** 275 mm
- K** 27 mm
- L** 110 mm
- M** Wall mounting hole

#### 4 Fit the main unit securely onto the screw(s).

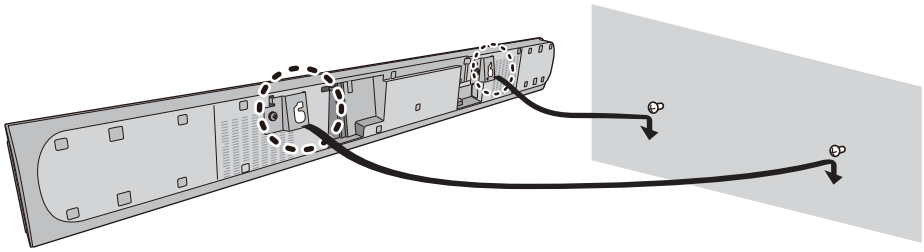

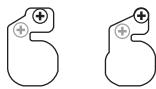
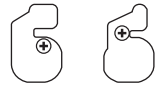
DO	DO NOT
 <ul style="list-style-type: none"><li>• Move the speaker so that the screw is in this position.</li></ul>	 <ul style="list-style-type: none"><li>• In this position, the speaker will likely fall if moved to the left or right.</li></ul>

#### 5 Secure the cord to the wall.

- Make sure that the slack of the cord is minimal.

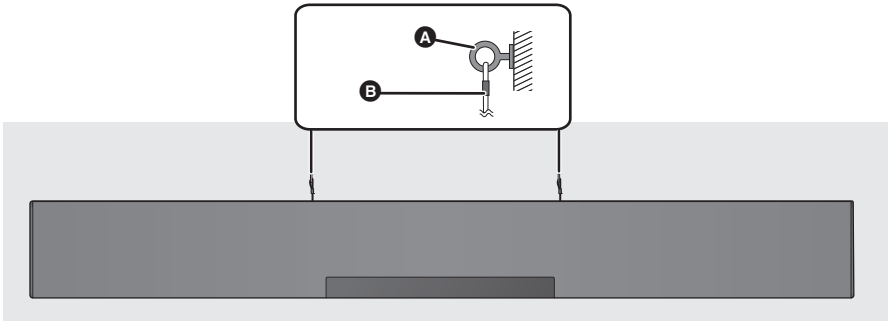

- A** Screw eye
- B** Cord

# Step 3 Wireless connections

## Active subwoofer wireless connection

### Preparation

- Turn on the main unit.

**1** Press [  ].

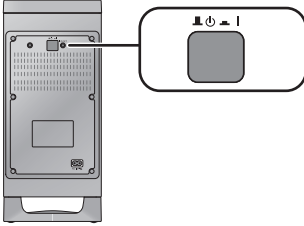

### Active subwoofer on/off button [ ]



Use this button to turn the active subwoofer on and off.

 I:

The active subwoofer is on.

 :

The active subwoofer is off.

The active subwoofer will still consume a small amount of power even when it is turned off (  ,  ).

**2** Check that the wireless link is activated.

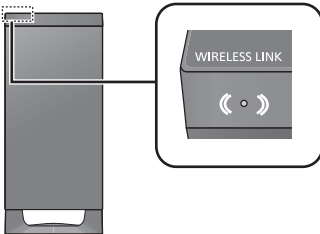

### WIRELESS LINK indicator

**Lights red:**

The wireless link is not activated.

**Lights green:**

The wireless link is activated.

**Blinks green:**

The active subwoofer is trying to activate the wireless link with the main unit.



The wireless link will be activated when the main unit and the active subwoofer are both turned on.

## Bluetooth® connection

By using the Bluetooth® connection, you can listen to the sound from the Bluetooth® audio device from this system wirelessly.

- Refer to the operating instructions of the Bluetooth® device for further instruction on how to connect a Bluetooth® device.

### Preparation

- Turn on the Bluetooth® feature of the device and place the device near the main unit.

## Bluetooth® pairing

**1** Press [  ] to select “BLUETOOTH”.

- If “PAIRING” is indicated on the display, go to step 3.

**2** Press and hold [  ] until “PAIRING” is indicated on the display.

**3** Select “SC-HTB485” from the Bluetooth® device’s Bluetooth® menu.

- If prompted for the passkey on the Bluetooth® device, enter “0000”.
- Once the Bluetooth® device is connected, the name of the connected device will be indicated on the display for a few seconds.



- You can register up to 8 devices with this system. If a 9th device is paired, the device that has not been used for the longest time will be replaced.

## Connecting a paired Bluetooth® device

**1** Press [  ] to enter Bluetooth® mode.

“BLUETOOTH READY” is indicated on the display.

**2** Select “SC-HTB485” from the Bluetooth® device’s Bluetooth® menu.

### ■ Disconnecting a Bluetooth® device

Press and hold [  ] until the “BLUETOOTH READY” is indicated on the display.



- When “BLUETOOTH” is selected as the source, this system will automatically try and connect to the last connected Bluetooth® device.
- The Bluetooth® device will be disconnected if a different audio source (e.g. “TV”) is selected.
- This system can only be connected to one device at a time.
- To change the sound quality, refer to page 24 “LINK MODE”.

## One-Touch Connection (Connecting by NFC)

### For NFC-compatible Bluetooth® devices (Android™ devices) only

Simply by touching an NFC (Near Field Communication)-compatible Bluetooth® device on the main unit, you can complete all preparations, from registering a Bluetooth® device to establishing a connection.

### Preparation

- Turn on the NFC feature of the device.
- Android device version lower than 4.1 requires the installation of the app “Panasonic Music Streaming” (free of charge).
  - 1 Enter “Panasonic Music Streaming” in the search box of Google Play™ to search, and then select “Panasonic Music Streaming”.
  - 2 Start the app “Panasonic Music Streaming” on the device.
    - Follow on-screen instructions on your device.
    - Always use the latest version of the app.

**1** Press [] to select “BLUETOOTH”.

**2** Touch and hold your device on the NFC touch area of the main unit [].  
(⇒ 6)

Do not move the Bluetooth® device until it beeps, displays a message or reacts in some way. Once the Bluetooth® device has reacted, move the device away from the main unit.

- When the registration and connection of the Bluetooth® device is complete, the name of the connected device is indicated on the display for a few seconds.
- The location of the NFC touch area differs depending on the device. When a connection cannot be established even if your Bluetooth® device has touched the NFC touch area of the main unit, change the position of the device. The condition may also improve if you download the dedicated app “Panasonic Music Streaming” and start it up.

**3** Start playback on the Bluetooth® device.



- If you touch another device to the main unit, you can update the Bluetooth® connection. The previously connected device will be disconnected automatically.
- When the connection is established, playback may start automatically depending on the type of device being used.
- The One-Touch Connection may not work properly depending on the type of device being used.

## Remote control code

When other Panasonic devices respond to this system's remote control, change the remote control code on this system and the remote control.

### Preparation

- Turn off all other Panasonic products.
- Turn on the main unit.

#### ■ To set the code to “REMOTE 2”

Press and hold [MUTE] and [OK] for more than 4 sec.

“REMOTE 2” is indicated on the display.

#### ■ To set the code to “REMOTE 1”

Press and hold [MUTE] and [▼] for more than 4 sec.

“REMOTE 1” is indicated on the display.

# Using this system

## Preparation

- Turn on the active subwoofer.
- Turn on the TV and/or connected device.

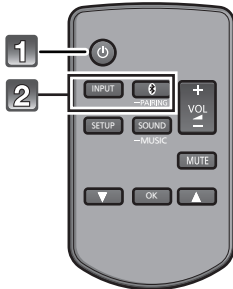

**1** Press [⏻] to turn on the main unit.

**2** Select the source.

Press	To select
[INPUT]	“TV” → “BD/DVD” ↑ “BLUETOOTH” ←
[🔊]	“BLUETOOTH”

- This remote control cannot be used to control the operations of the connected devices.

### ■ When “BLUETOOTH” is selected as the source

On the Bluetooth® device:

Select this system as the output source of the connected Bluetooth® device and start the playback.

### ■ When “BD/DVD” is selected as the source

On the TV and the connected device:

Select the TV’s input for this system and start the playback on the connected device.

### ■ To adjust the volume of this system

Press [+ VOL -].

- Volume range: 0 to 100

### ■ To mute the sound

Press [MUTE].

- While muting, “MUTE” is indicated on the display.
- To cancel, press the button again or adjust the volume.
- Muting is cancelled if the main unit is turned off.



**If this system does not operate as expected or sound is unusual, returning the settings to the factory preset may solve the problem. (⇒ 26)**

- If there is sound coming out of the TV’s speakers, reduce the volume of the TV to its minimum.

## 3D sound

This system provides a feeling that the sound and the image are as one.

- To change the applied effect, refer to "Sound menu". (⇒ right)

e.g., Image of 3D sound field

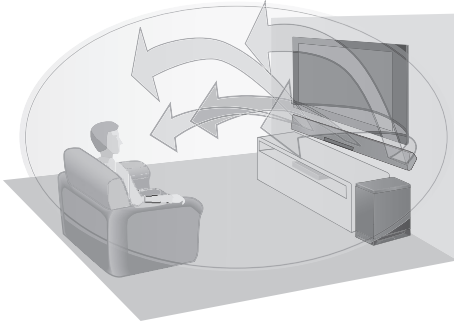

3D sound	
<b>Dolby®Virtual Speaker</b>	With this effect you can enjoy a surround sound effect similar to 5.1ch.
<b>3D surround effect</b>	Adding to the Dolby Virtual Speaker effect, Panasonic has applied its own sound field controlling technology to expand the sound field forwards, backwards, upwards, and downwards, providing a sound with depth and force that better matches 3D images.
<b>Clear-mode dialog</b>	Sports commentary and dialogs from TV dramas are heard as if the sound is coming from the TV, giving the feeling that the sound and the image are one. Also, the dialog will stand out from the other sounds during normal volume playback and when the volume is lowered for night time viewing.



- Dolby Virtual Speaker effect is ON except STEREO mode.
- To turn off Dolby Virtual Speaker and the 3D surround effects, select "STEREO" as the sound mode. (⇒ right)
- To turn off the 3D surround and the Clear-mode dialog effects, refer to "3D CLR DIALOG". (⇒ 23)

## Sound menu

- 1 Press [SOUND] repeatedly to select the sound effect.
- 2 Press [▲, ▼] repeatedly to select the desired setting and then press [OK].

<b>SOUND MODE</b>	<p><b>STANDARD:</b> Best suited for dramas and comedy shows.</p> <p><b>STADIUM:</b> Produces a realistic sound for live sports broadcasts.</p> <p><b>MUSIC:</b> Enhance the sound of musical instruments and songs.</p> <ul style="list-style-type: none"> <li>• Instead of steps 1 and 2, you can select "MUSIC" mode directly by pressing and holding [SOUND] until "MUSIC" is indicated on the display.</li> </ul> <p><b>CINEMA:</b> Produces three-dimensional sound unique to movies.</p> <p><b>NEWS:</b> Enhance the voice of news and sports commentaries.</p> <p><b>STEREO:</b> Play any source of sound in stereo.</p>
<b>SUBWOOFER</b>	<p>You can adjust the amount of bass. This system automatically selects the most suitable setting according to the type of playback source.</p> <p><b>LEVEL 1</b></p> <p><b>LEVEL 2:</b> Default for 2 channel audio source</p> <p><b>LEVEL 3:</b> Default for multi-channel audio source</p> <p><b>LEVEL 4</b></p> <p>The setting you make is retained and recalled every time you play the same type of source.</p>

<b>DIALOG</b>	Adjust the dialog level. <b>LEVEL 1</b> <b>LEVEL 2</b> <b>LEVEL 3</b> <b>LEVEL 4</b> "DIALOG" is not indicated on the display when "3D CLR DIALOG" is set to "OFF".
<b>H.BASS</b>	Enhance the harmonic bass effect. <b>ON</b> <b>OFF</b>
<b>3D CLR DIALOG</b>	The 3D Clear Mode Dialog feature creates a sound field similar to the sound coming from a TV screen and makes dialogues clearer. <b>ON</b> : 3D Surround, Clear Mode Dialog and Dolby Virtual Speaker effect <b>OFF</b> : Dolby Virtual Speaker effect The setting is set back to "ON" every time you turn the main unit on.
<b>DUAL AUDIO</b>	Sets the preferred audio channel mode when there are two audio modes received by this system. <b>M1</b> : Main <b>M2</b> : Secondary <b>M1 + M2</b> : Main + Secondary This effect only works if the audio output of the TV or player is set to "Bitstream" and "Dolby Dual Mono" is available in the sound source.
<b>AGC</b>	Auto gain control prevents sudden loud sound by reducing the sound level automatically when the input is too high. This function is suitable for TV broadcast that has sound level difference. <b>ON</b> <b>OFF</b> If the sound becomes unnatural, select "OFF".

<b>LOW VOL MODE</b>	Enhance the dialog in low volume condition. <b>ON</b> <b>OFF</b> Select "OFF" to cancel this effect if the dialog does not sound natural in low volume condition.
---------------------	--



- The default setting is underlined. Changed settings will be kept until it is changed again, unless otherwise indicated.

## Audio format

You can view the current audio format.

**Press and hold [OK] for more than 4 sec.**

<b>DOLBY DIGITAL</b>	Dolby Digital is the audio source.
<b>DTS</b>	DTS® is the audio source.
<b>PCM MULTI</b>	Linear pulse-code modulation is the audio source.
<b>PCM</b>	2 channel pulse-code modulation is the audio source.

# Setup menu

- 1 Press [SETUP] repeatedly to select the setup item.
- 2 Press [▲, ▼] repeatedly to select the desired setting and then press [OK].

<b>DIMMER</b>	Dims the display after 5 seconds of inactivity. <b><u>ON</u></b> <b><u>OFF</u></b>
<b>AUTO POWER DOWN</b>	The main unit automatically is turned off if there is no audio input and when you do not use it for approx. 20 minutes. <b><u>ON</u></b> <b><u>OFF</u></b>
<b>VOL LIMITATION</b>	Sets the volume limit to 50 when you turn on the main unit although the volume is set to above 50 before it is turned off. <b><u>ON</u></b> <b><u>OFF</u></b>
<b>BLUETOOTH STANDBY</b>	This function allows you to connect a paired Bluetooth® device when the main unit is in standby mode. <b><u>ON</u></b> <b><u>OFF</u></b> The main unit will be turned on automatically when you connect a paired Bluetooth® device. ● If this function is set to "ON", the standby power consumption will increase.

<b>LINK MODE</b>	Change the Bluetooth® connection link mode to suit the connection type. Make sure to disconnect the current connected device ("BLUETOOTH READY" is indicated on the display). <b>MODE 1:</b> Emphasis on connectivity. <b><u>MODE 2:</u></b> Emphasis on sound quality.
<b>VIERA LINK</b>	Turn on the VIERA Link function. <b><u>ON</u></b> <b><u>OFF</u></b> Select "OFF" when your HDAVI Control device does not work correctly with this system. ARC will be disabled. Connect an optical digital audio cable. Turn off all connected devices and then turn them on again after changing the setting.



- The default setting is underlined. Changed settings will be kept until it is changed again, unless otherwise indicated.



# Linked operations with the TV (VIERA Link “HDAVI Control™”)

## What is VIERA Link “HDAVI Control”?

VIERA Link “HDAVI Control” is a convenient function that offers linked operations of this system, and a Panasonic TV (VIERA) under “HDAVI Control”.

You can use this function by connecting the equipment with an HDMI cable. See the operating instructions for connected equipment for operational details.

## Preparation

- ① Confirm that the HDMI connection has been made. (⇒ 9, 10)
- ② Set the “HDAVI Control” operations on the connected equipment (e.g., TV).
- ③ For the optimal “HDAVI Control” operations change the following settings on the connected TV\*1.
  - Set the default speaker settings to this system.\*2
  - Set the speaker selection settings to this system.
- ④ Turn on all “HDAVI Control” compatible equipment and select the TV’s input for this system so that the “HDAVI Control” function works properly.
- ⑤ If a device is connected to the HDMI AV IN terminal, start play to check that the picture is displayed on the TV correctly.

## When the connection or settings are changed, repeat this procedure.

- \*1 The availability and function of the settings may vary depending on the TV. Refer to the operating instructions for the TV for details.
- \*2 If the TV has a default speaker setting within the VIERA Link setting items, choosing this system as the default speaker will automatically change the speaker selection to this system.



- VIERA Link “HDAVI Control”, based on the control functions provided by HDMI which is an industry standard known as HDMI CEC (Consumer Electronics Control), is a unique function that we have developed and added. As such, its operation with other manufacturers’ equipment that supports HDMI CEC cannot be guaranteed.
- This unit supports “HDAVI Control 5” function. “HDAVI Control 5” is the standard for Panasonic’s HDAVI Control compatible equipment. This standard is compatible with Panasonic’s conventional HDAVI equipment.
- Please refer to individual manuals for other manufacturers’ equipment supporting VIERA Link function.

## What you can do with VIERA Link “HDAVI Control”

To make sure that the audio is output from this system, turn the main unit on by using the TV’s remote control and selecting home cinema from the speaker menu of VIERA Link menu.

The availability and function of the settings may vary depending on the TV. Refer to the operating instructions for the TV for details.

### ■ Speaker control

You can select whether audio output is from this system or the TV speakers by using the TV menu settings.

### Home cinema

This system is active.

- When the main unit is in standby mode, changing the TV speakers to this system in the VIERA Link menu will automatically turn the main unit on.
- You can control the volume setting of this system using the volume or mute button on the TV remote control.
- If you turn off the main unit, TV speakers will be automatically activated.
- Audio will automatically be output from this system if the TV is compatible to VIERA Link “HDAVI Control 4” or later.

### TV

TV speakers are active.

- The volume of this system is set to its minimum.

### ■ Automatic input switching

When the following operations are performed, the main unit will automatically change the input to the corresponding source.

- When play starts on an HDMI connected device.\*3
- When the TV input or the TV channel is changed.

- \*3 If the speaker output setting on the TV is set to this system, the TV and the main unit turn on automatically (Power on link).

### ■ Power off link

When the TV is turned off, the main unit also turns off automatically. (This function does not work when Bluetooth® is the source.)

### ■ Automatic lip-sync function

(for HDAVI Control 3 or later)

Delay between audio and video is automatically adjusted by adding time-lag to the audio output, enabling you to enjoy smooth audio for the picture.



The delay information is automatically set if the TV is compatible to VIERA Link “HDAVI Control 3” or later and the VIERA Link is set to on.

# Troubleshooting

Before requesting service, make the following checks. If you are in doubt about some of the check points, or if the solutions indicated in the following guide do not solve the problem, consult your dealer for instructions.

## To return to the factory preset.

While the main unit is on, press and hold [⏪/I] on the main unit for more than 4 sec. ("RESET" is indicated on the display when this system is reset.)

**If this system does not operate as expected, returning the settings to the factory preset may solve the problem.**

- The remote control code will return to "REMOTE 1" when this system is returned to the factory preset. To change the remote control code, refer to page 20.

## General operation

### No power.

- Unplug the AC mains lead for 10 sec before plug in again.
- After turning the main unit on, if the main unit immediately turns off, unplug the AC mains lead and consult your dealer.
- If the main unit does not turn on by turning on TV (HDAVI control), turn on the main unit manually. If the problem persists, refer to "HDMI" in "Troubleshooting".

### The remote control does not work properly.

- The battery is depleted. Replace it with a new one. (⇒ 8)
- It is possible that the insulation sheet has not been removed. Remove the insulation sheet. (⇒ 8)
- It may be necessary to set the code of the remote control again after changing the battery of the remote control. (⇒ 20)
- Use the remote control within the correct operation range. (⇒ 8)
- Check which remote control signal sensor is working by the following operation.
  - Press and hold [INPUT] on the main unit for more than 4 sec. "ON TABLE" or "ON WALL" is indicated on the display for 4 sec.
  - Refer to page 8 "About remote control signal sensor" for the remote control signal sensor location.

### The main unit is automatically switched to standby mode.

"AUTO POWER DOWN" function is on.

The main unit will automatically switch to standby mode when no signal is input and no operation is performed for approx. 20 minutes. Refer to page 24 to turn this function off.

### The main unit is turned off when the TV's speakers are selected in the speaker control.

This is a normal feature when using VIERA Link (HDAVI Control 4 or later). Please read the operating instructions for the TV for details about its power save feature. (⇒ 25)

## HDMI

### This system does not operate correctly.

If the HDMI cable is connected to the wrong terminal (HDMI AV IN or HDMI AV OUT), this system will not operate correctly. Turn the main unit off, disconnect the AC mains lead and reconnect the HDMI cable(s). (⇒ 9, 10)

### VIERA Link related operations no longer function properly.

- Check the VIERA Link setting on the connected devices.
  - Turn on VIERA Link function on the connected devices.
  - Select this system as the speaker in the TV's VIERA Link menu.
- Have you turned the VIERA Link settings off? (⇒ 24)
- When the HDMI connections are changed, after a power failure or after the AC mains lead has been removed, VIERA Link operations may not function properly.
  - Turn on all the devices that are connected to the TV with an HDMI cable and then turn the TV on.
  - Turn off the VIERA Link settings of the TV and turn it on again. For details refer to the operating instructions for the TV.
  - While the main unit and the TV are connected with the HDMI cable, turn on the TV and then remove the main unit's AC mains lead and reconnect it again.

---

**The first few seconds of audio cannot be heard when using the HDMI connection.**

This may occur during DVD-Video chapter playback. Change the digital audio output setting on the connected device from "Bitstream" to "PCM".

---

**When operating an HDMI compatible device of a different brand, the main unit reacts in an unwanted manner.**

HDAVI Control commands may use a different signal depending on the brand of the device. In this case, turn VIERA Link off. (⇒ 24)

---

**When the main unit is turned on or off, audio and video are temporarily disabled**

When the main unit is turned on or off it is normal for the audio and video to be temporarily disabled. This is not a malfunction. This can occur when the device it is connected to, via HDMI, does not support Panasonic's VIERA Link feature (HDAVI Control 3 or later).

---

## Bluetooth®

---

**Pairing cannot be done.**

Check the Bluetooth® device condition.

---

**The device cannot be connected.**

- The pairing of the device was unsuccessful or the registration has been replaced. Try pairing the device again. (⇒ 19)
  - This system might be connected to a different device. Disconnect the other device and try pairing the device again.
- 

**The device is connected but audio cannot be heard through this system.**

For some built-in Bluetooth® devices, you have to set the audio output to "SC-HTB485" manually. Read the operating instructions for the device for details.

---

**The sound is interrupted.**

- The device is out of the 10 m communication range. Bring the Bluetooth® device closer to the main unit.
  - Remove any obstacle between the main unit and the device.
  - Other devices that use the 2.4 GHz frequency band (wireless router, microwaves, cordless phones, etc.) are interfering. Bring the Bluetooth® device closer to the main unit and distance it from the other devices.
  - Select "MODE1" for stable communication. (⇒ 24)
- 

**The One-Touch Connection (NFC feature) is not working.**

Make sure the main unit and the NFC feature of the device are turned on. (⇒ 20)

---

## Sound

---

**No sound (or image).**

- Turn muting off. (⇒ 21)
  - Check the connections to the other devices. (⇒ 9, 10)
  - Make sure that the received audio signal is compatible with this system. (⇒ 30)
  - Turn this system off and then on again.
  - If the main unit is connected to the TV with only an HDMI cable, make sure that the TV's HDMI terminal is labelled "HDMI (ARC)". If not, connect using the optical digital audio cable. (⇒ 9, 10)
  - If the main unit is connected to a Panasonic TV and turned on using the button on the main unit or the remote control, sound might not be output from this system. In this case, turn the main unit on using the TV's remote control. (⇒ 25)
  - If the connections are correct, there might be a problem with the cables. Redo the connections with different cables.
  - Check the audio output settings on the connected device.
- 

**The dual audio cannot be changed from main to secondary.**

If the audio received from the connected device is not "Dolby Dual Mono" or the output setting is not "Bitstream", the setting cannot be changed from this system. Change the setting on the connected device.

---

**The volume is lowered when the main unit is turned on.**

"VOL LIMITATION" is on.

If the main unit is turned off with the volume setting in the greater half (above 50), the main unit will automatically lower the volume to the middle (50) when the main unit is turned on. (⇒ 24)

---

**The dialog is too persistent or the dialog does not sound natural.**

This system has a function to make the dialog stand out when the volume is low. (⇒ 23)

---

---

**There is no audio.**

**The power of the main unit turns off automatically.**

(When the main unit detects a problem, a safety measure is activated and the main unit automatically switches to standby mode.)

- There is a problem with the amplifier.
- Is the volume extremely high?  
If so, lower the volume.
- Is this system placed in an extremely hot place?  
If so, move this system to a cooler place and wait a few moments and then try to turn it on again.

If the problem persists, confirm the display, turn this system off, remove the AC mains lead cord and consult your dealer. Please be sure to remember the display that was indicated and inform the dealer.

---

## Main unit displays

**“F61”**

- There is a problem with the amplifier of the system.
- Disconnect the AC mains lead and consult the dealer.

---

**“F70 HDMI” / “U701” / “U703”**

- Check HDMI connection.
- Turn off the main unit and then switch it on again.
- Disconnect the HDMI cable.

---

**“F76”**

- There is a problem with the power supply.
- Disconnect the AC mains lead and consult the dealer.

---

**“U704”**

- This system is receiving unsupported video format signal from the input source.
  - Change the video resolution setting on the connected device. (Refer to the operating instructions for the device.)
  - If there is no image, connect the device directly to the TV to change the settings.

---

## Active Subwoofer

**No power.**

Ensure the AC mains lead of the active subwoofer is connected properly.

---

**After turning the subwoofer on, it immediately turns off.**

Unplug the AC mains lead and consult your dealer.

---

**No sound from the subwoofer.**

- Check that the active subwoofer is turned on.
- Check that the WIRELESS LINK indicator lights green. (⇒ 19)

---

**The WIRELESS LINK indicator lights red.**

- There is no link between the main unit and the active subwoofer.
  - Check that the main unit is turned on.
  - Turn the active subwoofer off and then back on. Alternatively, turn the active subwoofer off, disconnect the AC mains lead and then reconnect it.
- The active subwoofer and the main unit may not be paired correctly. Try the following operation. (Wireless pairing)
  - ① Turn on the main unit and active subwoofer.
  - ② Press and hold [ID SET] on the rear of the active subwoofer for more than 3 sec. (The WIRELESS LINK indicator will blink in red.)
  - ③ While pressing and holding [INPUT] on remote control, press and hold [VOL +] on the main unit for more than 4 sec. (“SUBWOOFER PAIRING” will be indicated on the display.)
    - When the wireless pairing is successful, “PAIRED” will be indicated on the display for 2 sec and WIRELESS LINK indicator lights green.
  - ④ Turn the main unit off and on.
- Consult your dealer if the problem persists.

# About Bluetooth®

Panasonic bears no responsibility for data and/or information that is compromised during a wireless transmission.

## ■ Frequency band used

This system uses the 2.4 GHz frequency band.

## ■ Certification of this device

- This system conforms to frequency restrictions and has received certification based on frequency laws. Thus, a wireless permit is not necessary.
- The action below are punishable by law in some countries:
  - Taking apart or modifying the unit.
  - Removing specification indications.

## ■ Restrictions of use

- Wireless transmission and/or usage with all Bluetooth® equipped devices is not guaranteed.
- All devices must conform to standards set by Bluetooth SIG, Inc.
- Depending on the specifications and settings of a device, it can fail to connect or some operations can be different.
- This system supports Bluetooth® security features. But depending on the operating environment and/or settings, this security is possibly not sufficient. Transmit data wirelessly to this system with caution.
- This system cannot transmit data to a Bluetooth® device.

## ■ Range of use

Use this device at a maximum range of 10 m. The range can decrease depending on the environment, obstacles or interference.

## ■ Interference from other devices

- This system may not function properly and troubles such as noise and sound jumps may arise due to radio wave interference if the main unit is located too close to other Bluetooth® devices or the devices that use the 2.4 GHz band.
- This system may not function properly if radio waves from a nearby broadcasting station, etc. are too strong.

## ■ Intended usage

- This system is for normal, general use only.
- Do not use this system near equipment or in an environment that is sensitive to radio frequency interference (example: airports, hospitals, laboratories, etc.).

# Unit care

## ■ Clean this system with a soft, dry cloth

- When dirt is heavy, wring a cloth moistened in water tightly to wipe the dirt, and then wipe it with a dry cloth.
- When cleaning the speakers, use a fine cloth. Do not use tissues or other materials (towels, etc.) that can fall apart. Small grains may get stuck inside the speaker cover.
- Never use alcohol, paint thinner or benzine to clean this system.
- Before using chemically-treated cloth, carefully read the instructions that came with the cloth.

## ■ To dispose or transfer this system

This system may keep the user settings information in the main unit. If you discard the main unit either by disposal or transfer, then follow the procedure to return all the settings to the factory presets to delete the user settings. (⇒ 26, "To return to the factory preset.")

- The operation history may be recorded in the memory of the main unit.

# Licenses

Manufactured under license from Dolby Laboratories. Dolby, Pro Logic, and the double-D symbol are trademarks of Dolby Laboratories.

For DTS patents, see <http://patents.dts.com>. Manufactured under license from DTS Licensing Limited. DTS, the Symbol, & DTS and the Symbol together are registered trademarks, and DTS Digital Surround is a trademark of DTS, Inc. © DTS, Inc. All Rights Reserved.

HDMI, the HDMI Logo, and High-Definition Multimedia Interface are trademarks or registered trademarks of HDMI Licensing LLC in the United States and other countries.

HDAVI Control™ is a trademark of Panasonic Corporation.

The Bluetooth® word mark and logos are registered trademarks owned by Bluetooth SIG, Inc. and any use of such marks by Panasonic Corporation is under license. Other trademarks and trade names are those of their respective owners.

Google Play and Android are trademarks of Google Inc.

# Specifications

## AMPLIFIER SECTION

### RMS output power: Dolby Digital Mode

#### Front ch (L, R ch)

60 W per channel (6 Ω), 1 kHz, 10 % THD

#### Subwoofer ch

130 W per channel (8 Ω), 100 Hz, 10 % THD

#### Total RMS Dolby Digital mode power

250 W

## TERMINAL SECTION

### HDAVI Control

This unit supports "HDAVI Control 5" function.

### HDMI AV input (BD/DVD)

1

#### Input connector

Type A (19 pin)

### HDMI AV output (TV (ARC))

1

#### Output connector

Type A (19 pin)

### Digital audio input (TV)

#### Optical digital input

Optical terminal

### Sampling frequency

32 kHz, 44.1 kHz, 48 kHz  
88.2 kHz, 96 kHz (only LPCM)

### Audio format

LPCM, Dolby Digital, DTS Digital Surround™

### IR Blaster

#### Terminal Type

3.5 mm jack

### USB Port

For service use only.

## GENERAL

### Power consumption

#### Main unit

34 W

#### Active subwoofer

23 W

### In standby condition

#### Main unit<sup>※1</sup>

When "BLUETOOTH STANDBY" is "OFF"

Approx. 0.48 W

When "BLUETOOTH STANDBY" is "ON"

Approx. 3 W

#### Active subwoofer

Power switch off

Approx. 0.25 W

The wireless link is not activated

Approx. 1.3 W

### Power supply

AC 220 V to 240 V, 50 Hz

### Dimensions (W×H×D)

#### Main unit

##### For table top layout

950 mm×53 mm×110 mm

##### For wall mounting layout

950 mm×110 mm×57 mm

#### Active subwoofer

180 mm×408 mm×306 mm

### Mass

#### Main unit

##### For table top layout

Approx. 2.5 kg

##### For wall mounting layout

Approx. 2.6 kg

#### Active subwoofer

Approx. 5.0 kg

### Operating temperature range

0 °C to +40 °C

### Operating humidity range

20 % to 80 % RH (no condensation)



※1 When the other connected devices are turned off.

## SPEAKER SECTION

---

### Front speakers (Built-in)

#### Full range

6.5 cm cone type × 1/ch

### Active subwoofer

#### Woofers

16 cm cone type × 1

## WIRELESS SECTION

---

### Wireless module

#### Frequency Range

2.40335 GHz to 2.47735 GHz

#### No. of channels

38

## Bluetooth® SECTION

---

### Bluetooth® system specification

Bluetooth® Ver.2.1+EDR

### Wireless equipment classification

Class 2

### Supported profiles

A2DP

### Operating frequency

2.4 GHz band FH-SS

### Operating distance

10 m Line of Sight



- Specifications are subject to change without notice.
- Mass and dimensions are approximate.
- Total harmonic distortion is measured by a digital spectrum analyzer.

## Disposal of Old Equipment and Batteries

### Only for European Union and countries with recycling systems



These symbols on the products, packaging, and/or accompanying documents mean that used electrical and electronic products and batteries must not be mixed with general household waste.

For proper treatment, recovery and recycling of old products and used batteries, please take them to applicable collection points in accordance with your national legislation.

By disposing of them correctly, you will help to save valuable resources and prevent any potential negative effects on human health and the environment.

For more information about collection and recycling, please contact your local municipality.

Penalties may be applicable for incorrect disposal of this waste, in accordance with national legislation.



#### Note for the battery symbol (bottom symbol):

This symbol might be used in combination with a chemical symbol. In this case it complies with the requirement set by the Directive for the chemical involved.

## Safety information for customers in Norway

### NORSK

#### ADVARSEL

##### Produkt

- For å redusere faren for brann, elektrisk støt eller skade på apparatet:
  - Utsett ikke produktet for regn, fukt, drypping eller sprut.
  - Ikke plasser objekter som er fylt med væske, som vaser, på apparatet.
  - Bruk kun anbefalt tilbehør.
  - Fjern ikke deksler.
  - Reparer ikke denne enheten selv, overlatt service til kvalifisert servicepersonell.

##### Vekselstrømnett

- Nettstøpselet er trukket ut fra denne enheten. Installer denne enheten slik at nettstøpselet umiddelbart kan trekkes fra stikkkontakten.

#### FORSIKTIG

##### Produkt

- Plasser ikke åpen ild, slik som levende lys, oppå apparatet.
- Dette apparatet er beregnet for bruk under moderate klimaforhold.

##### Plassering

- For å redusere faren for brann, elektrisk støt eller skade på apparatet:
  - Ikke plasser apparatet i en bokhylle, et innebygget kabinett eller et annet lukket sted. Pass på at produktet er godt ventilert.
  - Apparatets ventilasjonsåpninger må ikke dekkes til med aviser, duker, gardiner eller lignende.



CE0682

## English

### Declaration of Conformity (DoC)

Hereby, "Panasonic Corporation" declares that this product is in compliance with the essential requirements and other relevant provisions of Directive 1999/5/EC.

Customers can download a copy of the original DoC to our R&TTE products from our DoC server:

<http://www.doc.panasonic.de>

Contact to Authorised Representative: Panasonic Marketing Europe GmbH,

Panasonic Testing Centre, Winsbergring 15, 22525 Hamburg, Germany

This product is intended for general consumer. (Category 3)

## Ελληνικά

### Δήλωση συμμόρφωσης (DoC)

Με την παρούσα, η "Panasonic Corporation" δηλώνει ότι το προϊόν αυτό είναι σύμφωνο με τις βασικές απαιτήσεις και άλλες σχετικές διατάξεις της οδηγίας 1999/5/ΕΚ.

Οι πελάτες μπορούν να κατεβάσουν ένα αντίγραφο του πρωτοτύπου DoC για τα R&TTE προϊόντα μας από τον DoC server μας:

<http://www.doc.panasonic.de>

Στοιχεία επικοινωνίας Εξουσιοδοτημένου Αντιπροσώπου:

Panasonic Marketing Europe GmbH,  
Panasonic Testing Centre, Winsbergring 15, 22525 Hamburg,  
Γερμανία

Αυτό το προϊόν προορίζεται για καταναλωτές. (Κατηγορία 3)

## Português

### Declaração de Conformidade (DoC)

Com o presente documento, a "Panasonic Corporation" declara que este produto é conforme os requisitos específicos e demais especificações referentes à Diretriz 1999/5/EC.

Os clientes podem baixar uma cópia da declaração de conformidade (DoC) para nossos produtos R&TTE do Server DoC:

<http://www.doc.panasonic.de>

Contacte o representante autorizado: Panasonic Marketing Europe GmbH,

Panasonic Testing Centre, Winsbergring 15, 22525 Hamburg, Alemanha

Este produto destina-se ao consumidor geral. (Categoria 3)

## Hrvatski

### Deklaracija o podobnosti (DoC)

Ovime, "Panasonic Corporation" izjavljuje da je ovaj proizvod udovoljava osnovnim zahtjevima i ostalim relevantnim uvjetima Smjernice 1999/5/EC.

Kupci mogu preuzeti kopiju originalne DoC za naše R&TTE proizvode s našeg DoC poslužitelja:

<http://www.doc.panasonic.de>

Adresa ovlaštenog predstavništva: Panasonic Marketing Europe GmbH,

Panasonic Testing Centre, Winsbergring 15, 22525 Hamburg, Njemačka

Ovaj proizvod je namijenjen za opću potrošnju. (kategorija 3)

## Lietuviškai

### Atitikties deklaracija (AD)

Bendrovė "Panasonic Corporation" patvirtina, kad šis gaminys tenkina direktyvos 1999/5/EB esminius reikalavimus ir kitas taikytinas nuostatas.

Mūsų R&TTE gaminių originalios atitikties deklaracijos kopiją klientai gali atsisiųsti iš mūsų AD serverio:

<http://www.doc.panasonic.de>

Igaliojoto atstovo adresas: "Panasonic Marketing Europe GmbH",  
Panasonic Testing Centre, Winsbergring 15, 22525 Hamburg,  
Vokietija.

Šis gaminys skirtas bendrajam vartojimui. (3 kategorija.)

## Slovensko

### Izjava o skladnosti (DoC)

S pričujočo izjavo podjetje "Panasonic Corporation" izjavlja, da so svoji izdelki skladni s poglavitnimi zahtevami in drugimi odgovarjajočimi predpisi direktive 1999/5/ES.

Stranka lahko naloži izvod izvirnega DoC o naših izdelkih R&TTE s strežnika DoC:

<http://www.doc.panasonic.de>

Pooblašteni zastopnik: Panasonic Marketing Europe GmbH,  
Panasonic Testing Centre, Winsbergring 15, 22525 Hamburg,  
Nemčija

Izdelek je namenjen splošni uporabi. (Razred 3)

## Slovensky

### Vyhlasenie o zhode (DoC)

"Panasonic Corporation" týmto prehlasuje, že tento výrobok je v zhode so základnými požiadavkami a ďalšími príslušnými ustanoveniami smernice 1999/5/ES.

Zákazníci si môžu stiahnuť kópiu pôvodného DoC na naše R&TTE výrobky z nášho servera DoC:

<http://www.doc.panasonic.de>

Kontakt na splnomocneného zástupcu: Panasonic Marketing Europe GmbH,

Panasonic Testing Centre, Winsbergring 15, 22525 Hamburg, Nemecko

Tento produkt je určený pre všeobecného spotrebiteľa. (Kategória 3)

## Norsk

### Samsvarserklæring (DoC)

"Panasonic Corporation" erklærer at utstyret er i samsvar med de grunnleggende krav og øvrige relevante krav i direktiv 1999/5/EF. Kundene kan laste ned en kopi av den originale samsvarserklæringen (DoC) for vårt R&TTE utstyr fra vår DoC server:

<http://www.doc.panasonic.de>

Kontakt vår autoriserte representant: Panasonic Marketing Europe GmbH,

Panasonic Testing Centre, Winsbergring 15, 22525 Hamburg, Tyskland

Utstyret er beregnet på den vanlige forbruker (klasse 3).

## Eesti keel

### Vastavusdeklaratsioon (DoC)

"Panasonic Corporation" kinnitab käesolevaga, et see toode on vastavuses põhiliste nõuete ja muude direktiivi 1999/5/EÜ asjakohaste sätetega.

Klientid saavad koopia meie R&TTE toodetele kehtiva originaalvastavusdeklaratsiooni koopia alla laadida meie DoC-serverist:

<http://www.doc.panasonic.de>

Võtte ühendust volitatud esindajaga: Panasonic Marketing Europe GmbH,  
Panasonic Testing Centre, Winsbergring 15, 22525 Hamburg, Saksamaa

See toode on mõeldud tavakasutajale. (III kategooria)

## Latviski

### Atbilstības deklarācija (DoC)

Kompānija "Panasonic Corporation" ar šo paziņo, ka šis izstrādājums atbilst būtiskām prasībām un citām saistošām Direktīvas 1999/5/EK prasībām.

Pircēji var lejupielādēt oriģinālo DoC kopiju mūsu R&TTE izstrādājumos no mūsu DoC servera:

<http://www.doc.panasonic.de>

Lūdzam sazināties ar pilnvaroto parstāvi Panasonic Marketing Europe GmbH,  
Panasonic Testing Centre, Winsbergring 15, 22525 Hamburg, Vācijā

Šis izstrādājums ir paredzēts parastam patērētājam. (3. kategorija)

## Български

### Декларация за съответствие (DoC)

"Panasonic Corporation" декларира, че този продукт съответства на съществените изисквания и другите приложими разпоредби на Директива 1999/5/EC. Потребителите могат да свалят копия от оригиналните DoC към нашите продукти от типа R&TTE от сървъра, на който се съхраняват DoC:

<http://www.doc.panasonic.de>

За контакт с оторизиран представител: Panasonic Marketing Europe GmbH,  
Panasonic Testing Centre, Winsbergring 15, 22525 Hamburg, Германия

Този продукт е предназначен за обща употреба. (Категория 3)

## Român

### Declarație de Conformitate (DoC)

Prin prezenta, societatea "Panasonic Corporation" declară că produsul este conform cu cerințele esențiale și cu alte norme corespunzătoare Directivei 1999/5/EC.

Clienții pot descărca o copie a DoC-ului original al produselor noastre R&TTE de la adresa noastră DoC din Internet: <http://www.doc.panasonic.de>

Contact la Reprezentanța autorizată: Panasonic Marketing Europe GmbH,  
Panasonic Testing Centre, Winsbergring 15, 22525 Hamburg, Germania

Acest produs a fost proiectat pentru clientela generală. (Categoriea 3)

## Magyar

### Megfelelőségi Nyilatkozat (DoC)

Ezennel a "Panasonic Corporation" kijelenti, hogy a jelen termék kielégíti az 1999/5/EK Irányelv létfontosságú követelményeit és más vonatkozó rendelkezéseit.

A vásárlók letölthetik az R&TTE termékek eredeti DoC másolatát a DoC szerverünkről:

<http://www.doc.panasonic.de>

Forduljon a hivatalos márkaképviselethez: Panasonic Marketing Europe GmbH,  
Panasonic Testing Centre, Winsbergring 15, 22525 Hamburg, Németország

A termék általános fogyasztóknak szánták. (3-as kategória)

## Türkçe

### Uygunluk Beyanı (DoC)

"Panasonic Corporation" işbu belge ile bu ürünün 1999/5/EC sayılı Direktif'in temel gereklerine ve diğer ilgili hükümlerine uygun olduğunu beyan etmektedir.

Müşterilerimiz R&TTE ürünlerimizle ilgili orijinal DoC belgesinin bir kopyasını DoC sunucumuzdan indirebilir:

<http://www.doc.panasonic.de>

Yetkili Temsilci ile temasa geçin:  
Panasonic Marketing Europe GmbH, Panasonic Testing Centre,  
Winsbergring 15, 22525 Hamburg, Almanya

İşbu ürün genel tüketicilere yöneliktir. (Kategori 3)

# Limited Warranty (ONLY FOR AUSTRALIA)

## Panasonic Warranty

1. The product is warranted for 12 months from the date of purchase. Subject to the conditions of this warranty Panasonic or its Authorised Service Centre will perform necessary service on the product without charge for parts or labour, if in the opinion of Panasonic, the product is found to be faulty within the warranty period.
2. This warranty only applies to Panasonic products purchased in Australia and sold by Panasonic Australia or its Authorised Distributors or Dealers and only where the products are used and serviced within Australia or its territories. Warranty cover only applies to service carried out by a Panasonic Authorised Service Centre and only if valid proof of purchase is presented when warranty service is requested.
3. This warranty only applies if the product has been installed and used in accordance with the manufacturer's recommendations (as noted in the operating instructions) under normal use and reasonable care (in the opinion of Panasonic). The warranty covers normal domestic use only and does not cover damage, malfunction or failure resulting from use of incorrect voltages, incorrect installation, accident, misuse, neglect, build-up of dirt or dust, abuse, maladjustment of customer controls, mains supply problems, thunderstorm activity, infestation by insects or vermin, tampering or repair by unauthorised persons (including unauthorised alterations), introduction of sand, humidity or liquids, commercial use such as hotel, office, restaurant, or other business or rental use of the product, exposure to abnormally corrosive conditions or any foreign object or matter having entered the product.
4. This warranty does not cover the following items unless the fault or defect existed at the time of purchase:
  - (a) Cabinet Part(s)
  - (b) Video or Audio Tapes
  - (c) SD cards or USB devices
  - (d) User replaceable Batteries  
etc
  - (e) DVD, Blu-ray or Recordable Discs
  - (f) Video / Audio Heads from wear and tear in normal use
  - (g) Information stored on Hard Disk Drive, USB stick or SD card
  - (h) DTV reception issues caused by TV Aerial / Cabling / Wall socket(s)
5. Some products may be supplied with Ethernet connection hardware. The warranty is limited on such products and will not cover
  - (a) Internet and or DLNA connection / setup related problems
  - (b) Access fees and or charges incurred for internet connection
  - (c) The use of incompatible software or software not specifically stipulated in the product operations manual;  
and
  - (d) Any indirect or consequential costs associated with the incorrect use or misuse of the hardware, its connection to the internet or any other device.
6. To claim warranty service, when required, you should:
  - Telephone Panasonic's Customer Care Centre on 132600 or visit our website referred to below and use the Service Centre Locator for the name/address of the nearest Authorised Service Centre.
  - Send or take the product to a Panasonic Authorised Service Centre together with your proof of purchase receipt as a proof of purchase date. Please note that freight and insurance to and / or from your nearest Authorised Service Centre must be arranged by you.
  - Note that home or pick-up/delivery service is available for the following products in the major metropolitan areas of Australia or the normal operating areas of the nearest Authorised Service Centres:
    - Plasma/LCD televisions / displays (screen size greater than 103 cm)
7. The warranties hereby conferred do not extend to, and exclude, any costs associated with the installation, de-installation or re-installation of a product, including costs related to the mounting, de-mounting or remounting of any screen, (and any other ancillary activities), delivery, handling, freighting, transportation or insurance of the product or any part thereof or replacement of and do not extend to, and exclude, any damage or loss occurring by reason of, during, associated with, or related to such installation, de-installation, re-installation or transit.

Panasonic Authorised Service Centres are located in major metropolitan areas and most regional centres of Australia, however, coverage will vary dependant on product. For advice on exact Authorised Service Centre locations for your product, please telephone our Customer Care Centre on 132600 or visit our website and use the Service Centre Locator.

In addition to your rights under this warranty, Panasonic products come with consumer guarantees that cannot be excluded under the Australian Consumer Law. If there is a major failure with the product, you can reject the product and elect to have a refund or to have the product replaced or if you wish you may elect to keep the goods and be compensated for the drop in value of the goods. You are also entitled to have the product repaired or replaced if the product fails to be of acceptable quality and the failure does not amount to a major failure.

If there is a major failure in regard to the product which cannot be remedied then you must notify us within a reasonable period by contacting the Panasonic Customer Care Centre. If the failure in the product is not a major failure then Panasonic may choose to repair or replace the product and will do so in a reasonable period of time from receiving notice from you.

**THIS WARRANTY CARD AND THE PURCHASE DOCKET (OR SIMILAR PROOF OF PURCHASE)  
SHOULD BE RETAINED BY THE CUSTOMER AT ALL TIMES**

If you require assistance regarding warranty conditions or any other enquiries, please visit the **Panasonic Australia** website **[www.panasonic.com.au](http://www.panasonic.com.au)** or contact by phone on **132 600**  
*If phoning in, please ensure you have your operating instructions available.*

### Panasonic Australia Pty. Limited

ACN 001 592 187 ABN 83 001 592 187

1 Innovation Road, Macquarie Park NSW 2113

PRO-031-F11 Issue: 4.0

01-01-2011

## For the United Kingdom and Ireland customers

### Sales and Support Information

#### Customer Communications Centre

- For customers within the UK: 0844 844 3899
- For customers within Ireland: 01 289 8333
- Monday–Friday 9:00 am – 5:00 pm (Excluding public holidays).
- For further support on your product, please visit our website: [www.panasonic.co.uk](http://www.panasonic.co.uk)

#### Direct Sales at Panasonic UK

- Order accessory and consumable items for your product with ease and confidence by phoning our Customer Communications Centre  
Monday–Friday 9:00 am – 5:00 pm  
(Excluding public holidays).
- Or go on line through our Internet Accessory ordering application at [www.pas-europe.com](http://www.pas-europe.com).
- Most major credit and debit cards accepted.
- All enquiries transactions and distribution facilities are provided directly by Panasonic UK.
- It couldn't be simpler!
- Also available through our Internet is direct shopping for a wide range of finished products. Take a browse on our website for further details.



Manufactured by: Panasonic Corporation  
Kadoma, Osaka, Japan  
Importer for Europe: Panasonic Marketing Europe GmbH  
Panasonic Testing Centre  
Winsbergring 15, 22525 Hamburg, Germany



Panasonic Corporation  
Web Site: <http://www.panasonic.com>

