

Operating Instructions

50cm Gas Cooker

GB

English, 1

HAGL 51 P
HAGL 51 K

Contents

GB

Introduction, 2-3

For Your Safety, 4

Installation Instructions, 5-8

Burner and Nozzle Specification, 8

Features, 9

Control Panel, 10

Hotplate, 11

Grill, 12

Oven, 13

Oven Cooking Chart, 14

Care and Cleaning, 15

Cooking Results Not Satisfactory?, 16

Something Wrong with your cooker?, 17

Disposal of the appliance, 18

Guarantee Information, 19

Service Information, 20

 **Hotpoint**

Please phone us on
08448 24 24 24
to activate your
guarantee

Introduction

GB

To the Installer:

Before installation, fill in the product details on the back cover of this book.

The information can be found on the rating plate.

To the User:

You must read the instructions prior to installing and using the appliance and then retain them for future reference.

! Before operating your new appliance please read this instruction booklet carefully. It contains important information concerning the safe operation, installation and maintenance of the appliance.

! Please keep these operating instructions for future reference. Pass them on to possible new owners of the appliance.

Retention of this Instruction Book

This Instruction Book must be kept handy for reference as it contains important details on the safe and proper use of the appliance.

If you sell or pass the appliance to someone else, or move house and leave it behind, make sure this Book is also provided so the new owner can become familiar with the appliance and safety warnings.

Your new appliance is guaranteed* and will give lasting service. This guarantee is only applicable if the appliance has been installed in accordance with the installation instructions detailed in this booklet.

To help make best use of your cooking equipment, please read this booklet carefully.

The cooker is designed specifically for domestic use and responsibility will not be accepted for use in any other installation.

When the cooker is first used an odour may be emitted, this will cease after a period of use.

When first using the cooker ensure that the room is well ventilated (e.g. open a window or use an extractor fan) and that persons who may be sensitive to the odour avoid any fumes.

It is suggested that any pets be removed from the room until the smell has ceased. This odour is due to temporary finish on oven liners and elements and also any moisture absorbed by the insulation.

Your new cooker is guaranteed and will give lasting service.

The guarantee is only applicable if the cooker has been installed in accordance with the Installation Instructions.

The cooker is designed specifically for domestic use and responsibility will not be accepted for use in any other installation.

* The guarantee is subject to the provisions that the appliance:

- (a) **Has been used solely in accordance with the Users Instruction Book.**
- (b) **Has been properly connected to a suitable supply voltage as stated on the rating plate attached to this equipment.**
- (c) **Has not been subjected to misuse or accident or been modified or repaired by any person other than the authorised employee or agent.**
- (d) **Has been correctly installed.**

Our policy is one of continual improvement in design and development, therefore strict accuracy of illustrations and descriptions cannot be guaranteed.



This appliance conforms with the following European Economic Community directives:

- 2009/142/EC of 30/11/09 (Gas) and subsequent modifications (only for models which use gas);
- 93/68/EEC of 22/07/93 and subsequent modifications.
- 2002/96/EC
- 1275/2008 (Stand-by/ Off mode)

Electrical connection

THE APPLIANCE MUST BE EARTHED

Install a standardised plug corresponding to the load indicated on the appliance data plate (see Technical data table). The appliance must be directly connected to the mains using an omnipolar switch with a minimum contact opening of 3 mm installed between the appliance and the mains. The switch must be suitable for the charge indicated and must comply with current electrical regulations (the earthing wire must not be interrupted by the switch). The supply cable must be positioned so that it does not come into contact with temperatures higher than 50°C at any point. Before connecting the appliance to the power supply, make sure that:

- The appliance is earthed and the plug is compliant with the law.
- The socket can withstand the maximum power of the appliance, which is indicated by the data plate.
- The voltage is in the range between the values indicated on the data plate.
- The socket is compatible with the plug of the appliance. If the socket is incompatible with the plug, ask an authorised technician to replace it. Do not use extension cords or multiple sockets.

! Once the appliance has been installed, the power supply cable and the electrical socket must be easily accessible.

! The cable must not be bent or compressed.

! The cable must be checked regularly and replaced by authorised technicians only.

! The manufacturer declines any liability should these safety measures not be observed.

IF THE FITTED PLUG IS REMOVED

The flexible mains lead must be correctly connected as below to a three pin plug of not less than 13 amp capacity. If a B.S. 1363 fused plug is used, it must be fitted with a fuse which is approved to B.S. 1362.

Important: the wires in the mains lead are coloured in accordance with the following code:

- Green & Yellow - **Earth**
- Blue - **Neutral**
- Brown - **Live**

The power supply cable must be type H05VV-F

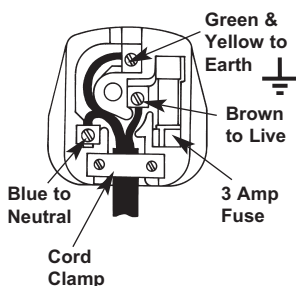

As the colours of the wires in the mains lead may not correspond with the coloured markings identifying the terminals in your plug, proceed as follows:

Connect the **Green & Yellow** wire to terminal marked “E” or  or coloured **Green** or **Green & Yellow**.

Connect the **Brown** wire to the terminal marked “L” or coloured **Red**.

Connect the **Blue** wire to the terminal marked “N” or coloured **Black**.

FAILURE TO OBSERVE THE ACCIDENT-PREVENTION REGULATIONS RELIEVES THE MANUFACTURER OF ALL LIABILITY.

IF A MOULDED PLUG IS FITTED

In the event of replacing a fuse in the plug supplied an ASTA approved fuse to BS1362 must be fitted.

NOTE: The fuse cover must be refitted when changing the fuse. In the event of losing the fuse cover the plug must not be used until a replacement fuse cover has been obtained and fitted. A new fuse cover can be obtained from your local Electricity Board.

The colour of the correct replacement fuse cover is that of the coloured marks or inserts in the base of the plug.

Make sure that the cable does not become trapped when pushing the cooker into position.

Replacing the cable

Use a rubber cable of the type H05VV-F with a cross section of 3 x 1.5 mm². The yellow-green earth wire must be 2 ÷ 3 cm longer than the other wires.

Technical Characteristics

Grill Usable Volume: 19 Litres
heating mode: Conventional

Main Oven Usable Volume: 41 Litres
heating mode: Conventional

ENERGY LABEL and ECODESIGN

Regulation (EU) No 65/2014 supplementing Directive 2010/30/EU.
Regulation (EU) No 66/2014 implementing Directive 2009/125/EC.
Standard EN 15181.

Hob

ECODESIGN

Regulation (EU) No 66/2014 implementing Directive 2009/125/EC.
Standard EN 30-2-1

Voltage and Frequency

220-240V~ 50/60Hz

For your Safety

GB

Please read the precautions below before using your cooker.

ALWAYS . . .

- ALWAYS make sure you understand the controls before using the cooker.
- ALWAYS check that all controls on the cooker are turned off after use.
- ALWAYS stand back when opening an oven door to allow heat to disperse.
- ALWAYS use dry, good quality oven gloves when removing items from the ovens.
- ALWAYS take care when removing items from the top oven/grill when the main oven is on, as the contents may be hot.
- ALWAYS keep the oven and grill doors closed when the cooker is not in use.
- ALWAYS place pans centrally over the hotplate burners and position them so that the handles cannot accidentally be caught or knocked or become heated by other burners.
- ALWAYS keep the cooker clean, as a build up of grease or fat from cooking can cause a fire.
- ALWAYS allow the cooker to cool before cleaning.
- ALWAYS follow the basic principles of food handling and hygiene to prevent the possibility of bacterial growth.
- ALWAYS keep ventilation slots clear of obstructions.
- ALWAYS turn off the electricity supply before cleaning or replacing an oven lamp.
- ALWAYS refer servicing to gas safe registered appliance service engineers.

NEVER . . .

- NEVER leave children unsupervised where the cooker is installed as all surfaces will get hot during and after use.
- NEVER allow anyone to sit or stand on any part of the cooker.
- NEVER store items that children may attempt to reach above the cooker.
- NEVER heat up unopened food containers as pressure can build up causing the container to burst.
- NEVER store chemicals, food stuffs, pressurised containers
- ALWAYS The appliance must be used by adults only for the preparation of food, in accordance with the instructions outlined in this booklet. Any other use of the appliance (e.g. for heating the room) constitutes improper use and is dangerous. The manufacturer may not be held liable for any damage resulting from improper, incorrect and unreasonable use of the appliance.

NOTE: The use of a gas cooking appliance results in the production of heat and moisture in the room in which it is installed. Always ensure that the kitchen is well ventilated; keep natural ventilation holes open or install a mechanical ventilation device (mechanical extractor hood).

In particular when using the grill or more than one hotplate burner, open a window if a mechanical ventilation device is not operating.

NEVER

NEVER

NEVER

NEVER

NEVER

NEVER

NEVER

NEVER

in or on the cooker, or in cabinets immediately above or next to the cooker.

fill a deep fat frying pan more than 1/3 full of oil, and never use a lid. **DO NOT LEAVE UNATTENDED WHILE COOKING.**

place flammable or plastic items on or near the hotplate.

use proprietary spillage collectors on the hotplate. use the cooker as a room heater.

dry clothes or place other times over or near to the hotplate or oven/grill doors.

wear garments with long flowing sleeves whilst cooking.

Do not let children play with the appliance.

The appliance should not be operated by people (including children) with reduced physical, sensory or mental capacities, by inexperienced individuals or by anyone who is not familiar with the product. These individuals should, at the very least, be supervised by someone who assumes responsibility for their safety or receive preliminary instructions relating to the operation of the appliance.

NOTICE

! VERY HOT SURFACES
FOOD OR GREASE ON THESE SURFACES COULD CAUSE SMOKE AND POSSIBLY EVEN BURN
YOU MUST KEEP THE OVEN AND GRILL CAVITIES CLEAN

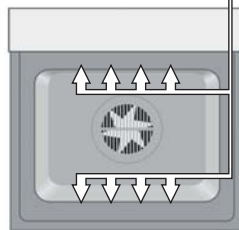

! ATTENTION
DURING INSTALLATION THE FEET OF THE APPLIANCE MUST BE LOWERED SO THAT AN AIR GAP OF AT LEAST 10MM (1CM) IS LEFT BETWEEN THE BASE OF THE APPLIANCE AND THE FLOOR.



! ATTENTION
WHEN USING THE MAIN OVEN YOU MUST ENSURE THAT THE BASE OF THE CAVITY IS NOT COVERED WITH ALUMINUM FOIL, UTENSIL OR ANY OTHER FORM OF COVERING. FAILURE TO DO THIS MAY RESULT IN THE CAVITY BEING DAMAGED.

The appliance must only be installed by a competent person. In the UK, gas safe registered installers undertake to work to safe and satisfactory standards. Before moving your cooker check that it is cool, and switch off at the cooker control unit. Movement of your cooker is most easily achieved by lifting the front as follows:

Open the grill door sufficiently to allow a comfortable grip on the underside front edge of the oven roof, avoiding any grill elements.

Note: Take care in moving the cooker as it is heavy. Take care to ensure that any floor covering is not damaged. (FIG. C)

Splashplate optional, apply to Parts Department (see Back Cover for contact number.)

The following instructions should be read by a qualified technician to ensure that the appliance is installed, regulated and technically serviced correctly in compliance with current regulations.

Important: remember to unplug the appliance from the mains before regulating the appliance or carrying out any maintenance work.

Positioning

Important: this unit may be installed and used only in permanently ventilated rooms according to the British Standards Codes Of Practice: B.S. 6172/B.S. 5440, Par. 2 and B.S. 6891 Current Editions. The following requirements must be observed:

- The cooker should not be installed in a bed sitting room with a volume of less than 20m³. If it is installed in a room of volume less than 5m³ an air vent of effective area of 110cm² is required, if it is installed in a room of volume between 5m³ and 10m³ a supplementary airvent area of 50cm² is required, if the volume exceeds 11m³ no airvent is required. However, if the room has a door or a window which opens directly to the outside no air vent is required even when the volume is between 5m³ and 11m³.
- During prolonged use of the appliance you may consider it necessary to open a window to the outside to improve ventilation.
- If there are other fuel burning appliances in the same room, B.S.5440 Part 2 Current Edition, should, be consulted to determine the requisite air vent requirements.

Installation of the cooker

For a correct installation of the cooker the following precautions must be followed:

The height of the cooker can be adjusted by means of adjustable feet in the plinth (900mm - 915mm). Adjust the feet by tilting the cooker from the side. Then install the product into position.

NOTE: This appliance must not be fitted on a platform. The cooker is designed to fit between kitchen cabinets spaced 500mm apart. The space either side need only be sufficient to allow withdrawal of the cooker for servicing. It can be used with cabinets one side or both as well as in a corner setting. It can also be used free-standing.

Adjacent side walls which project above hob level, must not be nearer to the cooker than 150mm or 65mm (Fig. A) and should be protected by heat resistant material. Any overhanging surface or cooker hood should not be nearer than 750mm. (Fig.A)

- The cooker may be located in a kitchen, a kitchen/diner or bed sitting room, but not in a bathroom or shower room.
- The hoods must be installed according to the requirements in the hood handbook.
- The wall in contact with the back of the cooker must be of flameproof material.
- The cooker is fitted with a safety chain that must be attached to a hook, secured to the wall behind the appliance.

Note: some models can have their gas connection inverted. It is important to make sure the safety chain is always situated on the side which corresponds to the hose holder (Fig. B).

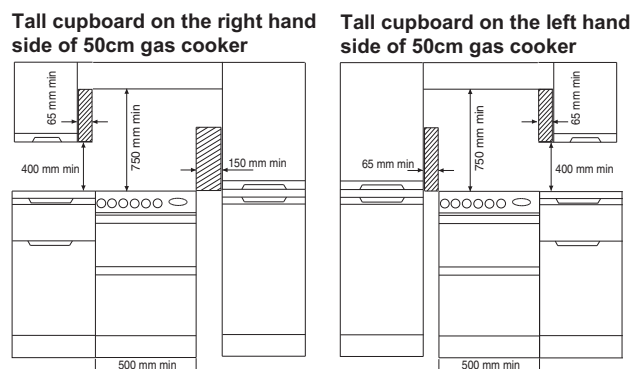

Fig. A

Installation

GB

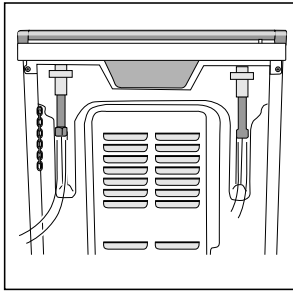
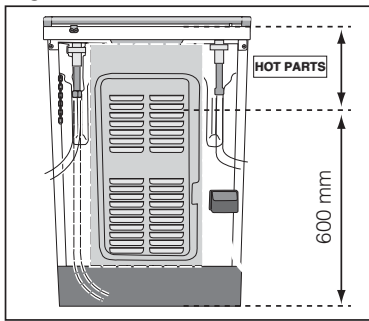

Fig. B

Gas connection

The cooker should be connected to the gas-supply by a gas safe registered installer. During installation of this product it is essential to fit an approved gas tap to isolate the supply from the appliance for the convenience of any subsequent removal or servicing. Connection of the appliance to the gas mains or liquid gas must be carried out according to the prescribed regulation in force, and only after it is ascertained that it is adaptable to the type of gas to be used. If not, follow the instructions indicated in the paragraph headed "Adaptation to different gas types". On some models the gas supply can be connected on the left or on the right, as necessary; to change the connection, reverse the position of the hose holder with that of the cap and replace the gasket (supplied with the appliance). In the case of connection to liquid gas, by tank, use pressure regulators that conform to the regulation in force. The



gas supply must be connected to the left of the appliance. Be sure that the hose does not pass through the rear of the cooker touching hot parts.

! Make sure the supply pressure

conforms with the values shown in the table entitled "Characteristics of the burners and nozzles".

When the cooker is installed between cabinets (recessed), the gas connection must be effected by an approved flexible hose with bayonet fitting (BS 669 Current Edition). The gas inlet for the cookers is a threaded G 1/2 gas female fitting.

Moving the Cooker

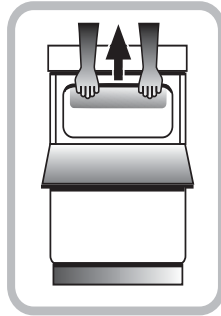

Fig. C

Connecting the gas supply

To make the connection, a flexible hose should be used corresponding to the current gas regulations which are:

- the hose must never be at any point in its length in contact with the "hot" parts of the cooker;
- the hose must never be longer than 1,5 metre;
- the hose must not be subject to any tension or torsional stress and it must not have any excessively narrow curves or bottlenecks;
- the hose must be easy to inspect along its entire length to check its condition;
- the hose must always be in good condition, never attempt to repair.

! The installation must comply with gas safety (installation and use) regulations 1984. In all cases for the above, by law, a qualified, gas safe approved engineer must be called for installation.

Disposing of the appliance

When disposing of the appliance please remove the plug by cutting the mains cable as close as possible to the plug body and dispose of it as described above.

Adapting the cooker to different types of gas

In order to adapt the cooker to a different type of gas with respect to the gas for which it was produced (indicated on the label attached to the lid), follow these steps:

a) replace the hose holder mounted on the appliance with that supplied in the bag of "cooker accessories".

b) Replacing the burner nozzles on the hob:

- remove the grids and slide the burners from their housings;
- unscrew the nozzles using a 7 mm socket spanner, and replace them with nozzles for the new type of gas (see table 1 "Burner and nozzle characteristics").
- replace all the components by repeating the steps in reverse order.

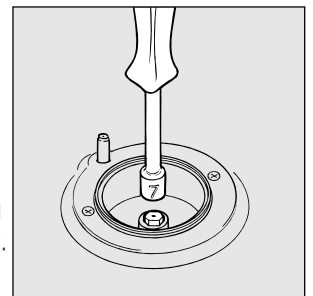

- c) Minimum regulation of the hob burners:
- turn the tap to minimum;
 - remove the knob and adjust the regulation screw, which is positioned in or next to the tap pin, until the flame is small but steady.

! In the case of liquid gas, the regulation screw must be screwed in to the bottom.

- check that the flame does not turn off when you turn the tap quickly from high to low.

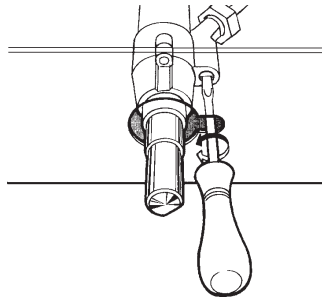

- d) Regulating the primary air of the burners:
The primary air of the burners requires no regulation.

Adapting to different types of gas

In order to adapt the oven to a different type of gas with respect to the gas for which it was manufactured (indicated on the label), follow these simple steps:

a) Replacing the oven burner nozzle

- open the oven door fully
- pull out the sliding oven bottom
- **unscrew the two screws and take off the shield protecting the burner (in main oven burner only).**
- Pry the fixing tab "V" and remove the oven burner
- Unscrew the oven burner nozzle using the socket spanner for the nozzles "Z", or a 7 mm socket spanner, and replace it with a nozzle suited to the new type of gas (see Table 1).

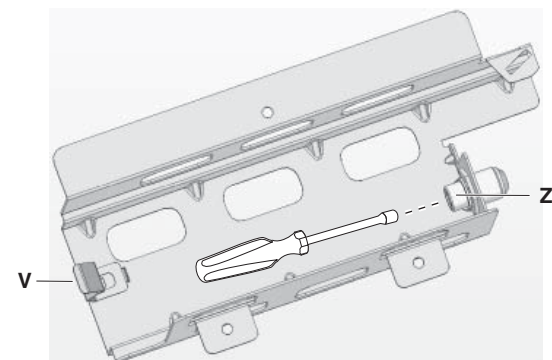
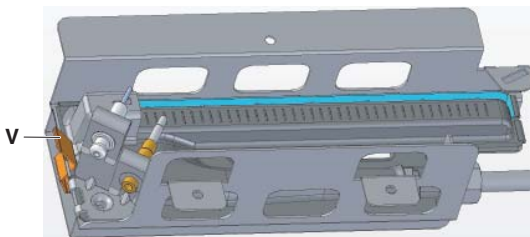

- Take particular care handling the spark plug wires and the thermocouple pipes.
- Replace all the parts, following the steps described above in the reverse order.

b) Minimum regulation of the gas oven burner with thermostat:

- light the burner as described in the paragraph "the oven knob" of the instruction booklet.
- turn the knob to Max for about 10 minutes and then turn the knob to the Min setting;
- remove the knob;
- regulate the screw positioned outside the thermostat pin until the flame is small but steady.

! In the case of liquid gas, the regulation screw must be screwed in to the bottom.

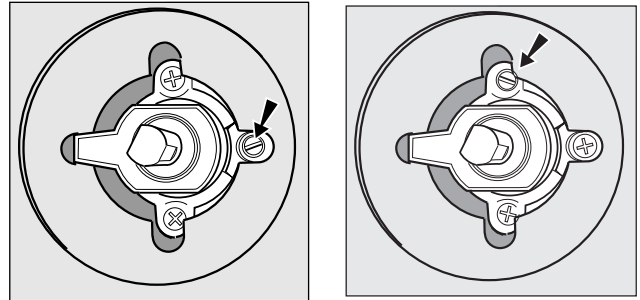

- check that the burner does not turn off when you turn the knob from Max to Min and when you open and close the oven door quickly.

Adapting the gas grill to different types of gas

Replacing the nozzle of the grill burner:

- remove the screw and then slide out the grill burner "V" (see Fig. E);
- unscrew the grill burner nozzle using the special socket spanner for the nozzles (see Fig. F) or better still a 7 mm socket spanner; replace the nozzle with a nozzle for the new type of gas (see table 1).

Burner and Nozzle Specification

GB

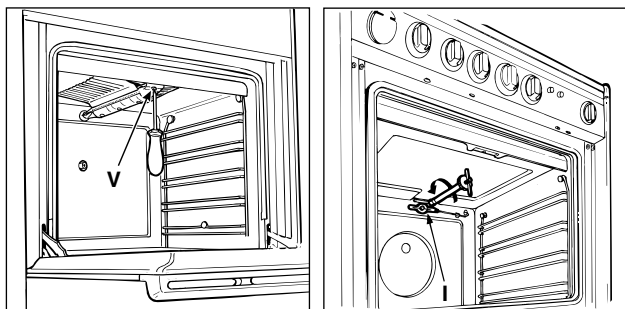
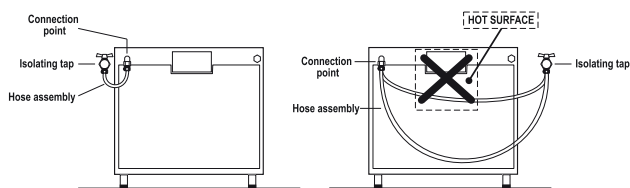

Fig.E

Fig.F



Important

On completion of the operation, replace the old rating sticker with one indicating the new type of gas used. This sticker is available from our Service Centres.

Note

Should the pressure of the gas used be different (or vary) from the recommended pressure, it is necessary to fit a suitable pressure regulator onto the inlet pipe in compliance with current National Regulations relative to "regulators for channelled gas".

HAGL 51 P
HAGL 51 K

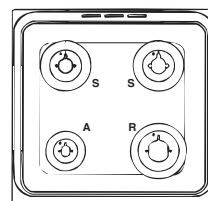

Burner	Diameter (mm)		Thermal Power kW (p.c.s.*)		Liquid Gas				Natural Gas	
					By-Pass 1/100 (mm)	Nozzle 1/100 (mm)	Flow* g/h		Nozzle 1/100 (mm)	Flow* l/h
							***	**		
Fast (Large)(R)	100	94	2,60	0,7	41	80	189	186	118	286
Semi Fast (Medium)(S)	75	69	1,90	0,4	30	70	138	136	104	181
Auxiliary (Small)(A)	51	46	1,00	0,4	30	52	73	71	76	95
Oven	-	-	2,60	0,6	36	71	189	186	115	248
Grill	-	-	2,50	1,3	63	80	182	179	122	238
Supply Pressures			Nominal (mbar)				28-30	37	20	
			Minimum (mbar)				20	25	17	
			Maximum (mbar)				35	45	25	

* At 15°C and 1013 mbar- dry gas

** Propane P.C.S. = 50,37 MJ/Kg

*** Butane P.C.S. = 49,47 MJ/Kg

Natural P.C.S. = 37,78 MJ/m³

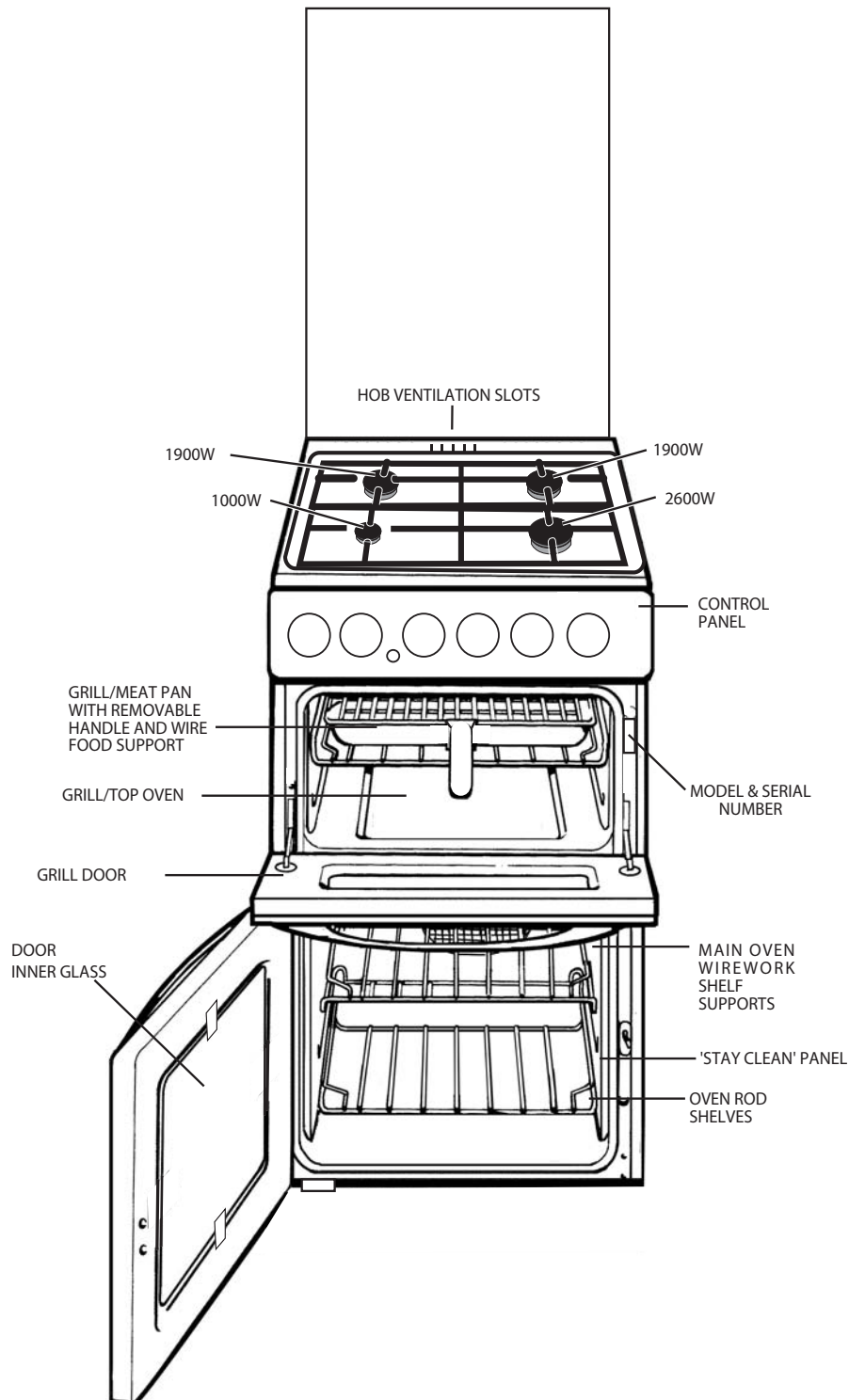

Control Panel

GB

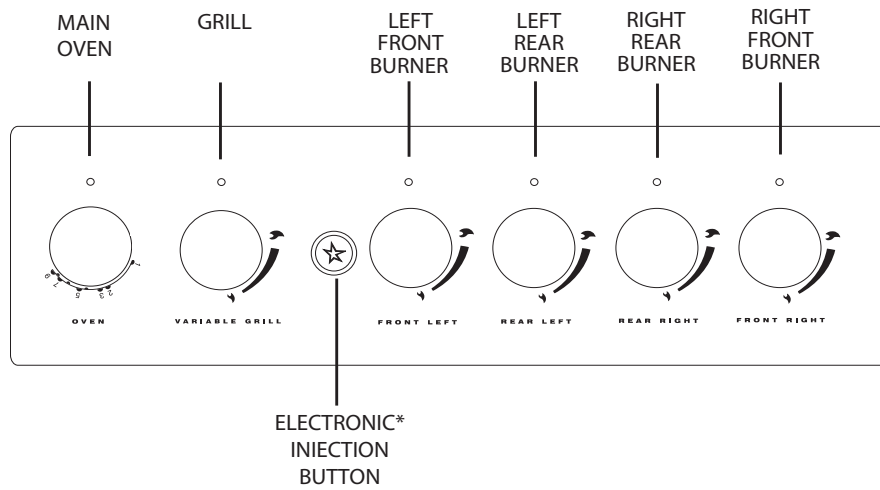

Control Knobs for the gas burners

The position of the gas burner controlled by each one of the knobs is shown by a solid ring •. To light one of the burners, press down and turn the corresponding knob counter clockwise to the maximum 🔥 setting. Each burner can be operated at its maximum, minimum or intermediate power. Shown on the knob are the different symbols for off • (the knob is on this setting when the symbol corresponds with the reference mark on the control panel), for maximum 🔥 and minimum 🔥. To obtain these settings, turn the knob counter clockwise with respect to the off position. To turn off the burner, turn the knob clockwise until it stops (corresponding again with the • symbol).

Electronic Ignition for the Gas Hob*

This device operates when a slight pressure is applied to the button marked with ★ symbol. To light a specific burner just press the button ★ while pushing the corresponding knob all the way in and turning it counter-clockwise until it lights. For immediate lighting, first press the button and then turn the knob.

! Should the burner flames accidentally go out, turn off the control knob and wait at least 1 minute before trying to relight.

Grill Control

This control switches on the top heating elements in the top oven..

The temperature of the top oven can be set anywhere between 80°C and 230°C by turning the knob clockwise.

To set the grill turn the corresponding knob to 🔥

The grill can be operated at minimum 🔥 and maximum 🔥 setting.

Main Oven Control

This control switches on the top and rear heating elements at various times in the main oven, dependent on which mode has been set.

The temperature of the main oven can be set anywhere between 80°C and 230°C by turning the knob clockwise from 1 to 9.

The hotplate lid is fitted with a safety device which cuts off the gas supply to the hotplate burners unless the lid is fully open. Do not use the safety device as a means of controlling the hotplate burners.

The hotplate has two high speed burners and two simmering burners which will accommodate pans between 100mm (4") and 240mm (9 1/2") diameter. All pans should be positioned centrally over the burners.

TO USE THE HOTPLATE

1. Remove any items or spillage from the top of the lid and then raise it to its fully open position.
2. Press the ignition button and then push in and turn the control knob of the chosen burner anti-clockwise to the large flame symbol. Continue to press the ignition button until the sparks light the gas.
3. Turn the control knob anti-clockwise to reduce the heat input. Only turn the control knob between the large flame symbol and the small flame symbol when adjusting the setting.
4. To turn off, turn the control knob fully clockwise to the symbol **O**.

DO NOT use the hotplate unless all pan supports are in position.

DO NOT use mis-shapen pans which may be unstable.

DO NOT use round base woks directly on the pan supports.

DO NOT use the glass lid as a working surface.

Each burner is fitted with a spark ignitor for lighting the gas. To ensure rapid lighting of the burners every time they are used, the ignitors must be kept **clean and dry**. Remove any food spillage or cleaning materials from the ignitor using a small nylon brush such as a tooth brush. Access to the ignitor can be achieved by lifting off the loose burner parts carefully when the burners are cool.

When the hotplate burner bodies and caps are removed for cleaning, be careful not to drop any food particles or cleaning materials into the burner bases, to avoid the possibility of blocking the gas jets.

If aluminium based pans are used, a silvery deposit may appear on the top edge of the pan support fingers. See 'Care and Cleaning' section for cleaning information.

SAFETY REQUIREMENTS FOR DEEP FAT FRYING

1. Never fill chip pans more than one third full with oil

- or fat.
2. Never leave oil or fat unattended during the heating or cooling period.
3. Never heat fat or fry with a lid on the pan.
4. Always dry food thoroughly before frying, and lower it slowly into the hot oil or fat. Frozen foods in particular will cause frothing and spitting if added too quickly.
5. Always keep the outside of the pan clean and free from streaks of oil or fat.

HOW TO DEAL WITH A FAT FIRE

1. **Do not** move the pan.
2. Turn off the hotplate burners.
3. Smother the flames with a fire blanket or damp cloth to extinguish the fire. **Do not** use water or a fire extinguisher as the force of it may spread the burning fat or oil over the edge of the pan.
4. Leave the pan for at least 60 minutes before moving it.

Models with Hob Gas Burner Safety Devices to Prevent Leaks

These models can be identified by the presence of the device itself.

! Since the hob burners are equipped with a safety device, you must hold the control knob in for about 3-7 seconds after the burner has been lighted to allow the gas to pass until the safety thermocouple has heated.

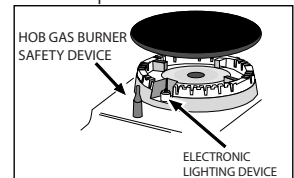

Practical Advice on Using the Burners

To use the burners as efficiently as possible, some basic guidelines should be followed:

- Use cookware that is the right size for each burner (see table) in order to prevent the flame from spreading beyond the bottom of the cookware.
- Only use cookware with flat bottoms.
- As soon as the boiling point is reached, turn the knob to the lowest setting.
- Always use lids with pots and pans.

Burner	ř Cookware diameter (cm)
Fast (R)	20 -22
Semi Fast (S)	16 - 20
Auxiliary (A)	10 - 14

Grill

GB

GRILLING MUST BE DONE WITH THE GRILL DOOR OPEN.

CONTROL KNOBS MAY BECOME HOT DURING GRILLING.

CAUTION: ACCESSIBLE PARTS WILL BECOME HOT WHEN THE GRILL IS USED - CHILDREN SHOULD BE KEPT AWAY.

To operate the grill proceed as follows:

- Open the grill door and remove the grill pan.
- Press the ignition button and then push in and turn the grill control knob anti-clockwise to the large flame symbol. Continue to press the ignition button until the spark lights the gas.
- Turn the control knob anti-clockwise to the desired setting. There is a delay of about six seconds whilst the safety device operates before the burner comes on full. Only turn the control knob between the large flame symbol and the small flame symbol when adjusting the setting.
- To turn off, turn the control knob fully clockwise to the symbol O

! When using the grill, the oven door must be left open by positioning the deflector "B" between control panel and deflector "A" to prevent the cooker knobs from overheating.

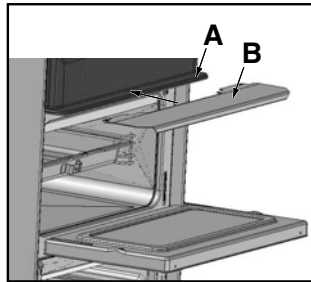

Slide the grill pan along the runner towards the rear of the grill compartment until it stops. An odour may be noticed when first using the grill - this should cease after a short period of use.

Grill can be started from cold but for the best result preheat for approximately five minutes. Most cooking is done with the heat on full, but it may be necessary after sealing the food to reduce the heat as required.

For au gratin dishes eg. Macaroni Cheese and meringue toppings eg. Baked Alaska place the dish on the floor of the grill compartment. The base of the grill pan can be used for warming fruit garnishes on the reduced setting.

DO NOT cover the grill pan or grid with aluminium foil as this can hold fat, intensify the heat and create a fire hazard.

Relighting' the burner

In the event of the burner flames being accidentally extinguished, turn off the burner control and do not attempt to re-ignite the burner for at least one minute.

Fixing the Grill PanHandle

The grill pan handle is detachable from the pan to facilitate cleaning and storage. Fix the pan handle securely before use:

1. Fit the handle to the grill pan so that the external 'hooks' embrace the edge of the pan (fig. 1)
2. Make sure that the middle part of the handle fits exactly the protruding support of the pan (fig .2) and holds the pan from the bottom.

The food must be placed on the rack in the grill pan. Position the grill pan on top of the oven rack. The best results are achieved by placing the oven rack on the uppermost shelves. Pouring a little water into the grill pan will make the collection of grease particles more efficient and prevent the formation of smoke.

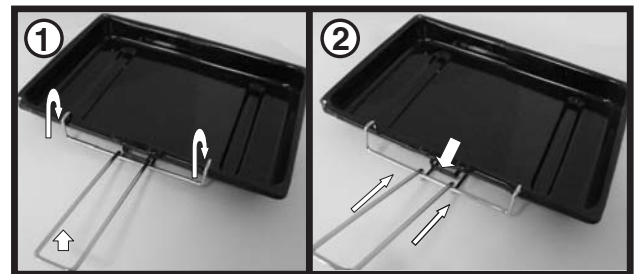

The main oven is fitted with a safety device that will cut off the gas supply to the burner if the flame has been extinguished for any reason. Each time the main oven is used, the safety device has to be activated by pushing and holding in the control knob for 3 seconds after the gas has lit.

The oven has different heat zones - the thermostat settings refer to the temperature on the middle shelf position; above this shelf it is hotter and below it is cooler. Two shelves provide five possible cooking levels enabling full use of the different temperatures inside the oven.

The maximum size of baking tray that should be used is 325mm x 350mm (13" x 14").

TO USE THE MAIN OVEN

1. Place the oven shelves in the appropriate positions (refer to cooking charts).
2. Press in the ignition button and then push in and turn the control knob fully anti-clockwise. Continue to push in the control knob for a further 3 seconds after the gas has lit to allow time for the safety device to operate. If the burner extinguishes when the control knob is released, repeat the procedure ensuring the control knob is fully depressed and allowing more time for the safety device to operate.
3. Turn the control knob clockwise to the required setting (refer to cooking chart).
4. To turn off, turn the control knob fully clockwise the the symbol **O**.

If for any reason the oven burner has not lit after 15 seconds, turn the control knob to the OFF position. Leave the main oven door open and wait for at least 1 minute before attempting to light the burner again. Never place dishes over the burner.

An odour may be noticed when first using the oven - this should cease after a short period of use.

RELIGHTING THE BURNER

In the event of the burner flames being accidentally extinguished, turn off the burner control and do not attempt to re-ignite the burner for at least one minute.

COLD START COOKING

Anything requiring long slow cooking such as casseroles and rich fruit cakes can be put into a cold oven. Satisfactory results can also be obtained with creamed mixture, rich pastries or yeast mixtures, but for perfection we recommend preheating the oven for about 15 minutes at the gas mark you require for cooking.

ROASTING OF LARGE POULTRY

The maximum weight of poultry that can be accommodated is 11.5kg (25 lbs) of suitable shape. It is important to check that the bird DOES NOT overhang the burner at the back of the oven.

STORAGE AND RE-HEATING OF FOOD

It is vitally important to strictly adhere to the basic principles of food handling and hygiene to prevent the possibility of bacterial growth.

1. If food is to be frozen or not served immediately, cool it in a clean container as quickly as possible.
2. Completely thaw frozen food in the refrigerator before re-heating.
3. Re-heat food thoroughly and quickly either on the hotplate or in a hot oven, Mk. 6, and then serve immediately.
4. Only re-heat food once.

'COOK CHILL' DISHES

These should always be placed in a pre-heated oven ideally on the first or second shelf position. Follow the packet instructions for cooking time.

ALUMINIUM FOIL

If using Aluminium Foil:

1. Remember that it is important to increase the cooking time by one third.
2. Never allow the foil to touch the sides of the oven.
3. Never cover the oven interior with foil.
4. Never cover the oven shelves with foil.

The oven temperature control marking are gas marked 0 to 9. The equivalent degrees Celsius (sometimes called Centigrade) and degrees Fahrenheit are shown below as a guide.

Gas Mark	MAIN OVEN (Centre Oven Temperature)	
	Celsius °C	Fahrenheit °F
1	120	250
2	150	300
3	175	350
•	195	385

Gas Mark	MAIN OVEN (Centre Oven Temperature)	
	Celsius °C	Fahrenheit °F
5	210	410
•	220	430
7	230	445
•	240	465
9	245	475

Oven Cooking Chart

GB

The following times and setting are for guidance only. You may wish to alter the setting to give a result more to your satisfaction. When a different setting to that shown below is given in a recipe, the recipe instructions should be followed. Allow 15 minutes preheat for best results. Always turn the thermostat knob to Mark 9 before selecting the appropriate gas Mark. Shelf position 1 is the highest.

Food	Gas Mark	Shelf Position	Approx. Cooking Time and Comments
Fish			
Oily and white fish	3 or 4	4	25-60 mins. depending on recipe
Meat and Poultry			
Beef	4 or 5	4	25-30 mins per 450g (1 lb) + 25 mins. extra
Ham	5	4	40 mins per 450g (1 lb) covered in foil plus 40 mins. extra
Lamb	5	4	30 mins per 450g (1 lb) + 30 mins extra
Pork	5	4	40 mins per 450g (1 lb) + 40 mins extra
Chicken	5	4	25 mins per 450g (1 lb) + 25 mins extra
Duckling & Goose	5	4	25 mins per 450g (1 lb) + 25 mins extra
Turkey	4 or 5	4 or 5	15-20 mins per 450g (1 lb) + 20 mins
Casseroles	3	3or4	2-6 hrs. depending on cut of meat
Vegetables			
Baked jacket potatoes	4 or 5	3	1½ - 3 hrs. until soft, depending on size
Puddings			
Milk Puddings (500ml/1 pt)	3	4	1¼-2½ stand dish on baking tray and started with warm milk
Baked Custard (500ml/1 pt)	3	4	45-60 mins. bain-marie
Baked Sponge Puddings	4	3	40-50 mins
Baked Apples	3	3	30-45 mins depending on type and size of apples
Meringue Topped Puddings	1	3or4	15 mins or until "tinged" with brown
Apple Tart (1 x205mm/8")	6	2	45-60 mins
Fruit Crumble	5	2	35 -45 mins
Cakes, Pastries & Biscuits			
Small Cakes 2 trays	5	2 and 4	15-25 mins.
1 tray	5	2	15-22mins.
Victoria sandwich (2 x 7")	4	2 and 4	20-30 mins
Swiss Roll (3 egg quantity)	5	2	15-20 mins.
Meringues	1	3	2-3 hrs
Christmas cake (1 x 205mm / 8")	2	3	Time depending on recipe
Madeira cake (1 x 180mm / 7")	4	4	1¼-1½ hrs.
Rich Fruit cake (1 x 180mm / 7")	2	4	Time depending on recipe
Scones	7	1 and 3	10-20 mins.
Shortbread (1 x 180mm / 7")	2	3	55 -65 mins.
Biscuits	4	1 and 3	10-20 mins.
Shortcrust Pastry	6	2	15 - 60 mins depending on use.
Rich Short Crust	5	1 and 3	20-30 mins.
Flaky/Puff Pastry	7	2	10-30 mins.
Choux Pastry	6	2	20-30mins.
Yeast Mixtures			
Bread - rolls	7	2 and 4	20-30 mins.
Miscellaneous			
Yorkshire Pudding:- large	7	1	30-40 mins
individual	7	2	20-30mins

When baking with two trays or tins on two levels, the top tray is removed first and the lower tray moved up to the top position for a few minutes longer.

Soft Margarine -
Use the oven settings recommended by the margarine manufacturer and not those indicated on the cooking chart.

Grill

Remove the grill pan and the wire grid food support, it is best to wash these items immediately after use to prevent stains from being burnt on when used again. Wipe out the Grill compartment, use a fine steel wool soap pad to remove stubborn stains from the grill runners and the floor of the compartment. Wipe over the control panel with a damp cloth and polish with a dry cloth.

Control Panel

Do not use cream cleaners, oven cleaners or aerosols, scouring pads or abrasive powder for cleaning the plastic knobs as damage will occur.

Decorative Trims

It is advisable to clean the decorative trims regularly to prevent any build up of soiling. The recommended method of cleaning is to wipe over the trims with a soft cloth wrung out in warm water or mild non-abrasive cleaner. (If in doubt try the cleaner on a small area of trim which is not noticeable in normal use). Then, after wiping with a cloth wrung out in clear water, dry with a soft clean cloth.

Doors

Wipe over the outer door glass panels with a cloth wrung out in warm soapy water, then after wiping with a cloth wrung out in clear water, dry with a soft clean cloth. Ensure that glass doors are not subjected to any sharp mechanical blows.

Glass Inner Door Panel (where fitted) *

Open the door fully **and unscrew the two screws securing the glass panel**, taking care not to allow the glass to fall. The glass panel may now be washed at the sink. Stubborn stains can be removed by using a fine steel wool soap pad. Ensure the glass panel is not subjected to any sharp mechanical blows. Take particular care not to damage the inner surface which is coated with a heat reflective layer. After cleaning, rinse and dry with a soft cloth. For slight soiling the inner glass panel may be cleaned, while still warm, without removing it from the door.

Warning: Oven must not be operated with inner door glass removed.

Take care during cleaning not to damage or distort the door seals. Do not lift the door seal from the oven chassis, if necessary remove the seal by carefully unhooking the corner clips.

Take care that the rating label edges are not lifted during cleaning, and furthermore that the lettering is not blurred or removed.

Top Cavity

Remove the rod shelves and grill pan. Use a fine steel wool soap pad to remove stubborn stains from the rod shelves, grill pan and the floor of the oven. Clean the glass part of the oven door using a sponge and a non-abrasive cleaning product, then dry thoroughly with a soft cloth. Do not use rough abrasive material or sharp metal scrapers as these could scratch the surface and cause the glass to crack.

Main Oven Cleaning

Main oven is fitted with "Stay Clean" panel. 'Stay Clean' panels are covered with a special enamel which absorbs cooking soils. At higher temperatures the soiling is slowly destroyed. In most cases normal cooking at higher temperatures will permit this cleaning to take place automatically. However, if higher cooking temperatures are not used regularly then it may be necessary, in order to prevent heavy soiling, to run the oven at maximum temperature for at least two hours, from time to time. The 'Stay Clean' panel can be washed in warm soapy water followed by rinsing in clear water. Dry well with a soft cloth.

NOTE: Do not use enzyme washing powder, harsh abrasives or chemical oven cleaners of any kind.

Oven Shelf Supports

The shelf supports are removable and dishwasher safe.

To remove hold the support at the front and pull away from the oven side, this can then be cleaned in a sink or a dishwasher. When removed it allows access to the oven side, which can be cleaned with warm soapy water.

To refit the support, insert the longer leg into the rear fixing hole and push in the front leg.

Replacing the Battery

The battery is not covered by the guarantee. Use an alkaline AA battery. The battery holder is located in the plinth panel below the oven door. Open the oven door fully. Press the tag on the left hand side of the battery holder/cover and withdraw it just enough to get access to the battery. Fit the new battery with the end marked "+" on the same side of the battery holder as the red lead. Replace the battery holder by pushing it firmly into the hole in the plinth.

* (only available on certain models)



Cooking Results Not Satisfactory?

GB

Problem	Check
Grilling Uneven cooking front to back	Ensure that the grill pan is positioned centrally below the grill element.
Fat splattering	Ensure that the grill is not set to too high a temperature.
Oven Baking Uneven rising of cake	Ensure that the oven shelves are level by using a spirit level on the rod shelf and adjusting, using suitable packing e.g. wood, under the feet of the appliance. This should be checked both left to right and front to back. Ensure that the food is positioned centrally in the oven.
Sinking of cakes	The following may cause cakes to sink: 1. Cooking at too high a temperature. 2. Using normal creaming method with soft margarine.
Over/Under cooking Fast/Slow cooking	Refer to the cooking times and temperatures given in the oven temperature charts, however, it may be necessary to increase or decrease temperatures by 10°C to suit personal taste. Do not use utensils greater than 2L' ins in height.

Something Wrong with your Cooker?

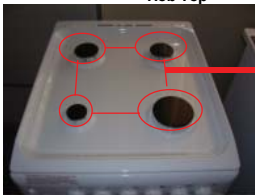
Before contacting your Service Centre or Installer, check the problem guide below, there may be nothing wrong with your cooker.

Problem	Check
<p>Ignition does not work</p> <div style="display: flex; justify-content: space-around; align-items: center; margin-top: 20px;"> <div style="text-align: center;"> <p>Hob Top</p>  </div> <div style="text-align: center;"> <p>Hotplate Burner</p>  </div> </div> <p style="text-align: center; margin-top: 5px;"> Burner Ports Ignitor </p>	<p>If all burners fail to ignite: Check that sparks appear at the burners; A clicking noise should be heard.</p> <p>If only one burner fails to ignite</p> <p>Check that the burner is dry and that spillage of food or cleaning fluid remains are not affecting the Ignitor or burner ports.</p> <p>Clean away any debris with a dry nylon brush such as an old dry toothbrush. If a wire wool pad has been used for cleaning around the burner ensure the Ignitor is free from any stray strands. Any water on the burner should be dried with a cloth or kitchen towel.</p> <p>On the hotplate make sure that all burner parts are correctly seated</p>
<p>Oven or Grill will not stay lit when the control knob is released</p>	<p>For correct ignition of oven/grill burners press the ignition button and then push in and turn control knobs anti-clockwise. Continue to press the ignition button until the spark lights the gas. Once alight release the ignition button and continue to hold the control knob in for a further 6 to 10 seconds. Then release the control knob and set to the required temperature.</p> <p>The flame should now stay alight. If the flame does not hold and goes out wait 30 seconds and try again</p>
<p>Oven Temperature seems too high or too low</p>	<p>Check that the temperature has been set in accordance with the temperature charts. It may be necessary to increase or decrease the recommended temperature by 10 C to suit your taste</p>
<p>Oven does not cook evenly.</p>	<p>Check the temperature and shelf position are as recommended in the temperature charts</p> <p>Check that the Utensil being used in the oven allow sufficient air flow around them.</p> <p>Check that the cooker is level.</p>
<p>Hotplates are slow to boil or will not simmer</p>	<p>Check that your pans conform to the recommendations in these instructions.</p>
<p>Odour or smoke when using your new cooker</p>	<p>This is normal and should cease after a short period.</p>
<p>Condensation / Steam in the Oven After Use</p>	<p>Condensation and steam is a by product of cooking food with a water content. To help minimise always: A) Try to avoid leaving food in the oven to cool after being cooked B) Use a covered Utensil wherever possible</p>
<p>Condensation on the Wall at the Rear of the Cooker</p>	<p>Steam and/or condensation may appear from the vent at the rear of the appliance when using an oven, particularly when cooking foods with a high water content (Such as Oven Chips or Chicken). This is normal and any excess should be wiped off</p>

Disposal of your product

To minimise the risk of injury to children please dispose of your product carefully and safely. Remove all doors and lids. Remove the mains cable (where fitted) by cutting off flush with the appliance and always ensure that no plug is left in a condition where it could be connected to the electricity supply.

To help the environment, Local Authority instructions should be followed for the disposal of your product.



Disposal of old electrical appliances

The European Directive 2002/96/EC on Waste Electrical and Electronic Equipment (WEEE), requires that old household electrical appliances must not be disposed of in the normal unsorted municipal waste stream. Old appliances must be collected separately in order to optimise the recovery and recycling of the materials they contain and reduce the impact on human health and the environment.

The crossed out „wheeled bin” symbol on the product reminds you of your obligation, that when you dispose of the appliance it must be separately collected.

Consumers should contact their local authority or retailer for information concerning the correct disposal of their old appliance.

Respecting and conserving the environment

- Whenever possible, avoid pre-heating the oven and always try to fill it. Open the oven door as little as possible because heat is lost every time it is opened. To save a substantial amount of energy, simply switch off the oven 5 to 10 minutes before the end of your planned cooking time and use the heat the oven continues to generate.
- Keep gaskets clean and tidy to prevent any door energy losses
- If you have a timed tariff electricity contract, the “delay cooking” option will make it easier to save money by moving operation to cheaper time periods.
- The base of your pot or pan should cover the hot plate. If it is smaller, precious energy will be wasted and pots that boil over leave encrusted remains that can be difficult to remove.
- Cook your food in closed pots or pans with well-fitting lids and use as little water as possible. Cooking with the lid off will greatly increase energy consumption
- Use purely flat pots and pans
- If you are cooking something that takes a long time, it's worth using a pressure cooker, which is twice as fast and saves a third of the energy.

Guarantee

12 months Parts and Labour Guarantee

Your appliance has the benefit of our manufacturer's guarantee, which covers the cost of breakdown repairs for twelve months from the date of purchase.

This gives you the reassurance that if, within that time, your appliance is proven to be defective because of either workmanship or materials, we will, at our discretion, either repair or replace the appliance at no cost to you.

The guarantee is subject to the following conditions:

- The appliance has been installed and operated correctly and in accordance with our operating and maintenance instructions.
- The appliance is only used on the electricity or gas supply printed on the rating plate.
- The appliance has been used for normal domestic purposes only.
- The appliance has not been altered, serviced, maintained, dismantled or otherwise interfered with by any person not authorised by us.
- Any repair work must be undertaken by us or our appointed agent.
- Any parts removed during repair work or any appliance that is replaced become our property.
- The appliance is used in the United Kingdom or Republic of Ireland.

The guarantee does not cover:

- Damage resulting from transportation, improper use, neglect or interference or as a result of improper installation.
- Replacement of any consumable item or accessory. These include but are not limited to: plugs, cables, batteries, light bulbs, fluorescent tubes and starters, covers and filters.
- Replacement of any removable parts made of glass or plastic.

THE GUARANTEE WILL NOT APPLY IF THE APPLIANCE HAS BEEN USED IN COMMERCIAL OR NON-DOMESTIC PREMISES.

5 Year Parts Guarantee

Hotpoint also offers you a FREE 5 year parts guarantee. This additional guarantee is conditional on you registering your appliance with us and the parts being fitted by one of our authorised engineers. There will be a charge for our engineer's time. To activate the extra parts warranty on your appliance, simply call our registration line on **08448 24 24 24 (ROI 01 230 0800)**

Extended Guarantees

We offer a selection of protection plans that enable you to fully cover yourself against the expense of repair bills for the life of your policy. To find the ideal plan for you please call our advice line on **08448 226 226 (ROI 01 230 0233)**

Free Helpdesk Service

We have a dedicated team who can provide free advice and assistance with your appliance if you experience any technical difficulties within the first 90 days of ownership. Simply call our Hotpoint Service Hotline on **08448 224 224 (ROI 0818 313 413)** for telephone assistance, or, where necessary, to arrange for an engineer to call.

After Sales Service

No one is better placed to care for your Hotpoint appliance during the course of its working life than us - the manufacturer.

Essential Contact Information

Hotpoint Service

We are the largest service team in the country offering you access to 400 skilled telephone advisors and 1100 fully qualified engineers on call to ensure you receive fast, reliable, local service.

UK: 08448 224 224

Republic of Ireland: 0818 313 413

www.hotpoint.co.uk

Please note: Our advisors will require the following information:

Model number

Serial number

Parts & Accessories

We supply a full range of genuine replacement parts as well as accessory products that protect and hygienically clean your appliance to keep it looking good and functioning efficiently throughout its life.

UK: 08448 225 225

Republic of Ireland: 0818 313 413

www.hotpointservice.co.uk

Appliance Registration

We want to give you additional benefits of Hotpoint ownership. To activate your FREE 5 year parts guarantee you must register your appliance with us.

UK 08448 24 24 24

Republic of Ireland: 01 230 0800

www.hotpointservice.co.uk

As part of Hotpoint's continued commitment to helping the environment, Hotpoint reserves the right to use quality, recycled components to keep down customer costs and minimise material wastage.

Indesit Company UK Limited, Morley Way, Peterborough, PE2 9JB
Indesit Company, Unit 49 Airways Industrial Estate, Dublin 17