

GB

English

AQUALTIS

AQC9 4F7

 This symbol reminds you to read this instruction manual.

! Keep this instruction booklet on hand in order to refer to it when necessary. Take it with you when you move, and, should you sell this appliance or pass it on to another party, make sure that this booklet is supplied along with the dryer so that the new owner may be informed about warnings and suggestions on how the dryer works.

! Read these instructions carefully; the following pages contain important information on installation and suggestions on how the appliance works

Contents

Important Information, 2-3

Installation, 4

Where to put your dryer
Ventilation
Electrical connection
Levelling the tumble dryer
Before you start using your dryer

Dryer Description, 5

Open the door
The Features
Control Panel

The Display, 6

Start and Programmes, 7-12

Choosing a Programme
Special Programmes
Table of Programmes
The Controls

Laundry, 13-14

Sorting your laundry
Wash care labels
Special clothing items
Drying times

Warnings and Suggestions, 15

General safety
Save energy and respect the
Environment

Maintenance and Care, 16

Switching off the electricity
Clean the filter after each cycle
Check the drum after each cycle
Empty the Water Container after each cycle
Cleaning the Heat Pump Filter
Cleaning the dryer

Troubleshooting, 17

Service, 18

Spare parts
Disposal

Hotpoint Guarantee, 19

Hotpoint After Sales Service, 20

Important Information

GB

For your Condenser dryer to operate efficiently, you must follow the regular maintenance schedule shown below:

Fluff Filter – You MUST Clean the fluff filter after every drying cycle.



Step 1
Open the door of your dryer.

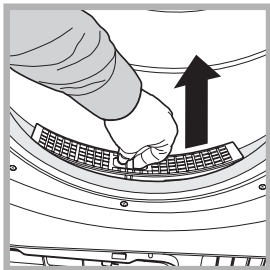

Step 2
Pull out the filter (using the two finger grips).

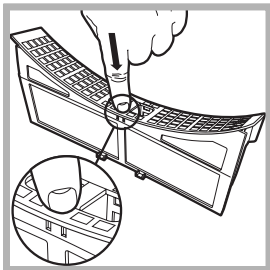

Step 3
Open the filter by releasing the clip.

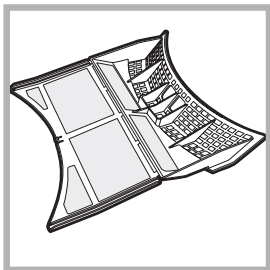

Step 4
Clean any fluff deposits from the inside surface of the filter mesh.

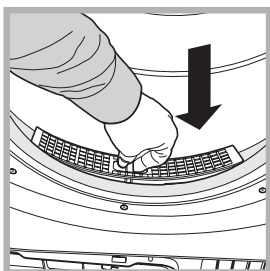

Step 5
Refit the filter – Never run the dryer without a filter.

Failure to clean the filter after every drying cycle will affect the drying performance of your machine – It will take longer to dry and as a result will use more electricity during drying.

Water Container – You must empty the water container after every drying cycle.

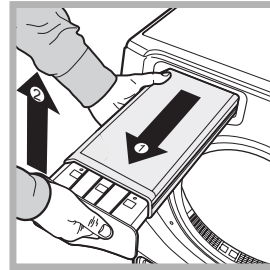

Step 1
Pull the water container towards you and remove it fully from the dryer.

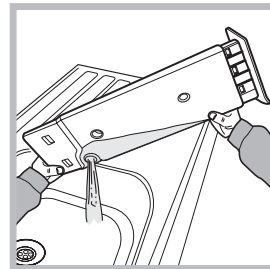

Step 2
Empty the Water from the Container.

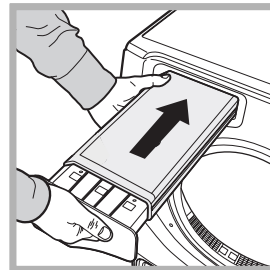

Step 3
Refit the Water Container ensuring that it is pushed fully back into position.

Failure to empty the Water Container will result in:
- The machine will stop heating (so the load may be wet at the end of the cycle).
- The "Empty Water" light will flash to tell you that the Container is full.

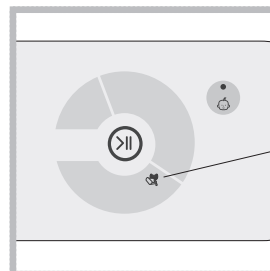

! The water bottle/clean filter light comes on when you select a programme to remind you to make sure that the water bottle is empty and that the filter is clean before starting a new cycle'

Priming the Water Collection System
When your dryer is new, the Water Container will not collect Water until the system is primed, this will take 1 or 2 drying cycles. Once primed it will collect Water during every cycle.

Heat Pump Filter Unit - You must clean the fluff from the filter every five drying cycles to maintain the correct functioning of your dryer ! However for optimum performance and to save energy we recommend that it is cleaned before each drying cycle.

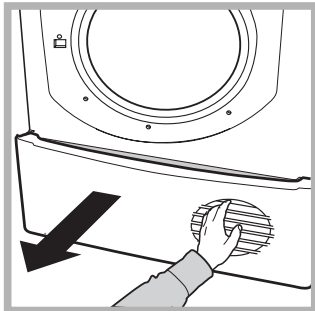

Step 1
Open the heat pump filter Cover.
- hold the handle and pull towards you.

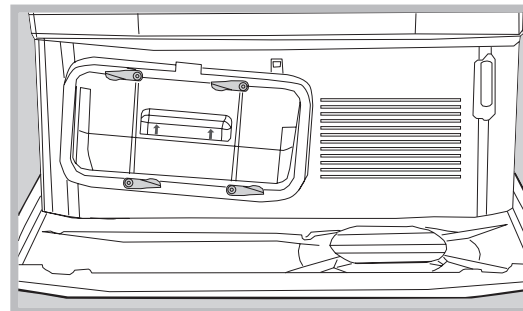

Step 5
Refit the filter unit - ensure that the unit is pushed in fully, then turn all 4 clips into the horizontal position to lock the cover.

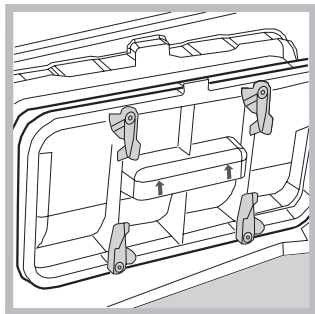

Step 2
Remove the filter unit by rotating the 4 clips to the vertical position then pulling the filter unit towards you. (There may be some water in the filter this is normal).

Failure to clean Heat Pump Filter will reduce the drying performance and could cause premature failure of your dryer. To maintain optimum drying performance we recommend you clean this filter after every drying cycle.

! Warning: The front of the heat pump is made from thin metal plates.

Take care that you do not damage these or cut yourself when cleaning, removing or replacing the filter unit.

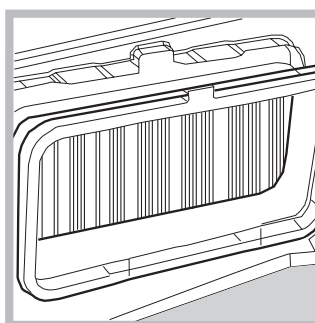

Step 3
If there is any build up of fluff on the plates Carefully clean this off with a damp cloth, sponge or vacuum cleaner.
Never use your Fingers.

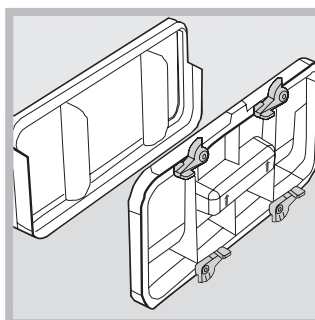

Step 4
Separate the two parts of the filter unit, clean any fluff deposits from the inside surface of the filter mesh. Clean the seals. Assemble the two parts.

Installation

GB

Where to put your dryer

Place your dryer at a distance from gas ranges, stoves, heaters, or cooktops because flames can damage the appliance. The dryer should be installed in an ambient room temperature of between 20 to 23°C for optimum performance. But will function if the room is between 14 and 30°C. If you are going to install the appliance under a work counter, be sure to leave a 10 mm space between the top and any other objects on or above the machine and a 15 mm space between the sides and lateral furnishings or walls. This is to ensure proper air circulation.

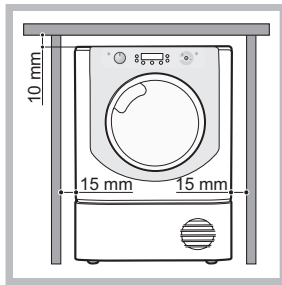

Ventilation

When the dryer is in use, there has to be adequate ventilation. Make sure you put your dryer in an environment that is not damp and has proper air circulation throughout. Airflow around the dryer is essential to condense the water produced during the washing, the dryer will not operate efficiently in an enclosed space or cupboard.

If using the dryer in a small or cold room some condensation will be experienced.

We do not recommend that the dryer is installed in a cupboard but the dryer must never be installed behind a lockable door, a sliding door or a door with a hinge on the opposite side to that of the dryer door.

Water Drain

If the machine is positioned close to a drain it is possible to drain the condensed water directly without using the water bottle. In which case it is no longer necessary to empty the water bottle at the end of each cycle. If the Dryer is positioned above or close to a Washing Machine the same drainage can be used. Just remove the tube indicated in figure A and connect it to the drainage. If the drainage is further away than the length of the tube it is possible to buy and connect a tube of the same diameter and the necessary length in order to reach the drainage. To install the new tube just substitute the existing one as indicated in figure B inserting it in the same place.

The drain tube has to be below 1 m from the bottom of the Dryer.

Once the Dryer has been installed please assure that the drain tube is not bent or kinked.

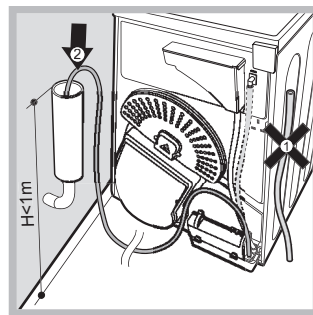
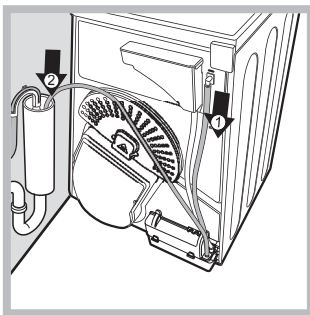

Electrical connection

Make sure of the following before you insert the plug into the electrical socket:

- Ensure your Hands are dry.
- The socket must be grounded.
- The socket must be able to sustain the machine's maximum power, which is indicated on the rating label (see *Dryer Description*).
- Power voltage must be within the values indicated on the rating label (see *Dryer Description*).
- The socket must be compatible with the dryer's plug. Should this not be the case, replace the plug or the socket.

Do not use extension cords.

The dryer must not be installed outdoors, even if the space is sheltered. It can be very dangerous if exposed to rain or storms.

Once installed, the dryer's electrical wire and plug must be within reach.

The power cord must not be bent or squashed.

The power cord is supplied fitted with a BS1363 plug and with a 13 amp BS1362 fuse. If it is necessary to fit a replacement fuse, it must be a 13 Amp ASTA approved to BS1362 type.

WARNING: The plug must not be used without a fuse cover. If a replacement fuse holder/cover is required, it must be of the same colour coding or wording as shown on the base of the plug.

Replacements are available from authorised dealers.

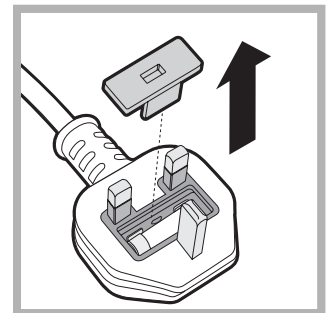
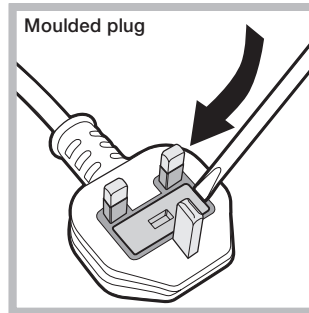

Changing the plug

The wires in the power cord are coloured in accordance with the following.

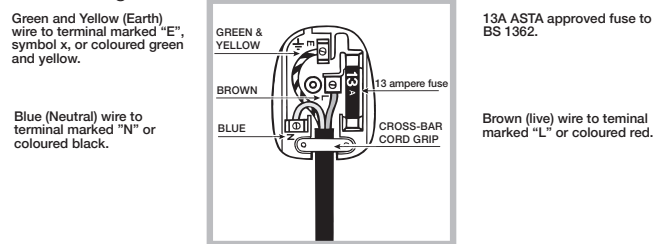

If the plug being replaced is a non-rewirable type, then the cut-off plug must be disposed of safely. DO NOT leave it where it can be inserted into a socket and create a shock hazard.

The power cord should be checked periodically and replaced by a cord specially prepared for this dryer and fitted only by authorized technicians (see *Service*). New or longer power cords are supplied at an extra charge by authorized dealers.

The manufacturer denies any responsibility should any of these rules not be followed.

If in doubt about any of the above consult a qualified electrician.

Levelling the tumble dryer

The dryer must be installed level for correct operation.

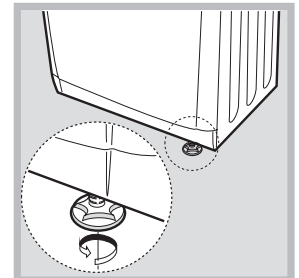
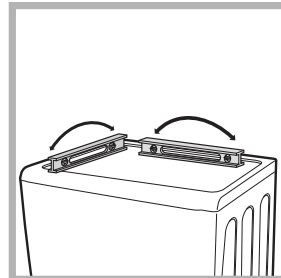

When you have installed your dryer in its final location check that it is level first side-to-side, then front to back. If the dryer is not level, adjust the two legs up or down until your dryer is level.

Before you start using your dryer

Once you've installed your dryer and before you use it, clean the inside of the drum to remove any dust that could have accumulated during transportation.

Warning! Before you use your dryer ensure that its has been in a upright position for at least 6 hours.

To open door

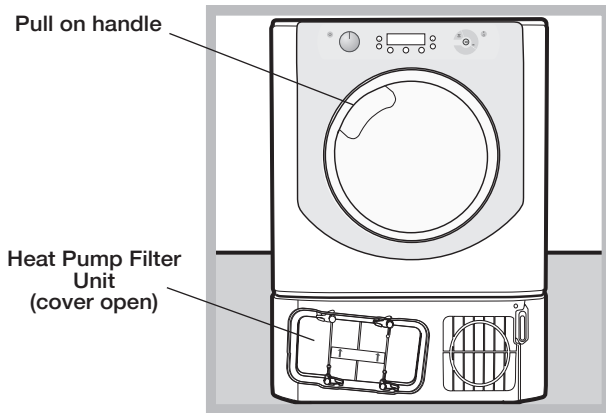

The Features

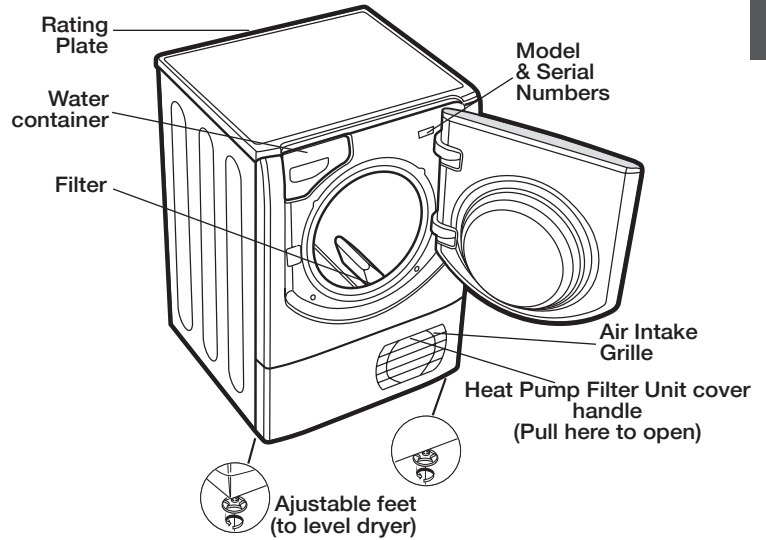

Control Panel

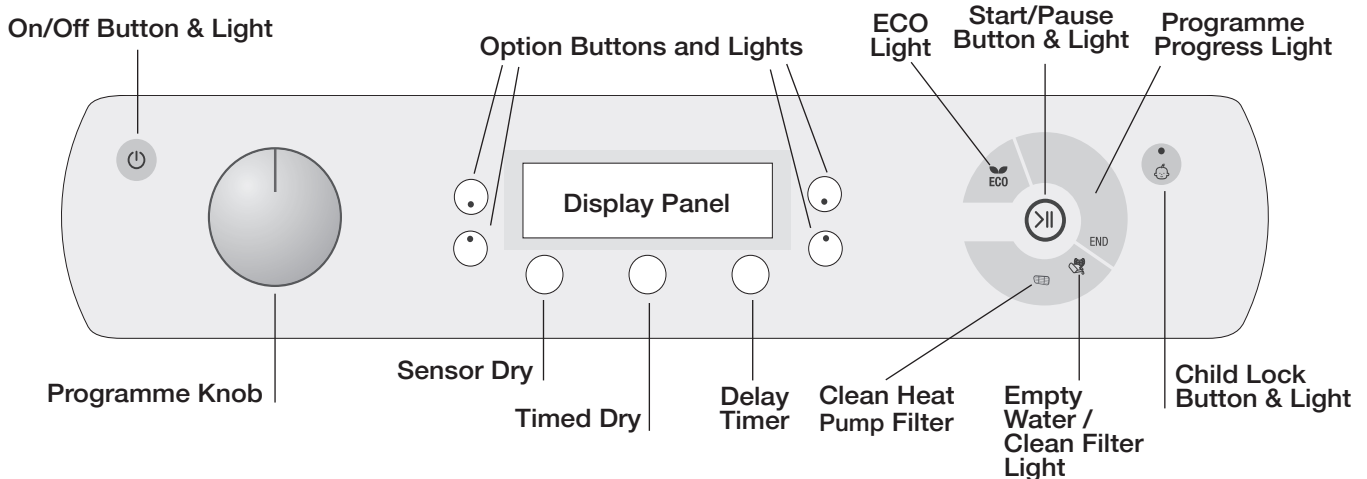

The On/Off button/light , if the dryer is running and this button is pressed and held for more than 3 seconds the dryer is turned off. The light signals that your dryer is in use or ready to select a programme.

The **Programmes** knob sets the programme: rotate until the indicator is pointing to the programme you want to select (see *Start and Programmes*).

The **Option** buttons/ lights select available options for your selected programme. The lights indicate that the option has been selected (see *Start and Programmes*).

The **Display Panel** has three sections: Sensor Dry = Drying level, Timed dry = Drying time and Time to End / Delay start each with a corresponding selection button (see *The Display*).

START/PAUSE button with indicator light : when the green indicator light flashes slowly, press the button to start the programme. When the cycle has started, the indicator light is illuminated in a fixed manner. To pause the programme, press the button again; the indicator light will turn orange and begin to flash again. To restart the programme from the point at which it was interrupted, press the button again (see *Start and Programmes*).

The Programme Progress Lights indicate each state of the programme by turning on as appropriate. (see *Start and Programmes*).

Note: this light also flashes amber during post care phase.

The **Empty Water** indicator “H2O” signals that the water container should be emptied. The light will take a few seconds to go out after replacing the empty water container; the dryer must be running for this to happen (see *The Controls*). Note: if the water bottle is full the display shows “H2O” and the  indicator flashes, the heat is turned off and your clothes will not dry.

The **Empty Water Clean Filter** Light  gives a reminder before every programme, that its essential to clean the filter and empty the water container every time the dryer is used (see *Maintenance and Care*).

The **Clean Heat Pump Filter** Light  gives a reminder, that its essential to clean this filter at regular intervals (see *Maintenance and Care*).

The **Child Lock** button/light  Press and hold this button after selecting your programme and any options. This prevents the programme settings from being changed. When the light is lit the other buttons and programme knob are disabled. Hold the button to cancel and the light will go out.

ECO Light - this light is illuminated as you select options that use less energy (see the controls).

The Display

GB

The Display has three sections each with its corresponding button.

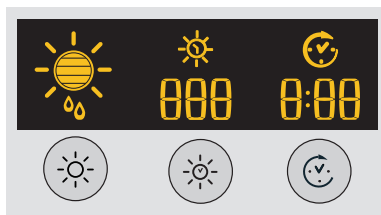

Sensor Dry

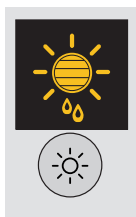

After selecting a programme that has a Sensor Dry Option, press and release the button until the required dryness sensing level is displayed. If the sensing option is not available the display will flash and the buzzer beeps three times.

! Some drying programmes are not compatible with all 7 sensor drying levels.

Dryness levels available

 **Damp dry:** the most delicate level which makes sure that your clothes are not dripping wet. After a hand-wash the perfect level to then hang your clothes if you do not want to tumble dry them all the way to the end.

 **Iron Dry:** a very delicate drying, It is useful for garments you would like to iron afterwards.

 **Hanger plus:** just the drying status to hang delicate garments up (as curtains).

 **Hanger Dry:** just the drying level to hang the garments up.

 **Light dry:** ideal for delicate clothes to be folded and placed into the cupboard.

 **Cupboard Dry:** the garments are completely dry and are ready to be folded and placed in the cupboard.

 **Ready to Wear:** used for clothes to be worn straight away once the cycle is completed.

Timed Dry

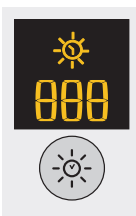

After selecting a Programme that has a Timed Dry Option, press the Timed Button to select a drying time. The display will reduce the selected time each time you press and release this button (see Start and Programmes). Each press decreases the set time **220, 180, 150, 120, 90, 60, 40** and then repeats. If the Timed Dry option is not available the display will flash and the buzzer beeps three times. The selected time remains displayed after the programme starts and can be changed during the programme if you wish.

! You can either choose a sensor dry level or a drying time.

Delay Start



After selecting a Programme that has a Delay Start Option a delay start time can be selected.

Each press of the Delay start button  advances the delay setting in 1 hour increments from "1h" to "24h" then "OFF" and then after five seconds cancels the delay.

For delays of 10 hours or more the display counts down the time in hours until 10 hours, then the display shows "9:59" and then counts down in minutes. For delays of 9 hours or less the display shows hours and minutes and then counts down in minutes for all of the delay.

After the Start/Pause Button  is pressed the delay time can be changed or cancelled if you wish.

When the delay period finished the  symbol is off and the **Time to End** is displayed.

If you have chosen a timed drying the display during programming will show the drying time only in the timed drying display in the middle. After having pressed start the machine will turn the time display on and visualize the countdown of the programme time.

Time to End

If the delay icon  is off the time displayed is the **Time to End** of the programme running.

When timed programmes are selected the time displayed throughout the cycle is the actual time remaining.

When an Automatic programme is selected the time displayed is an estimate of the time remaining.

When the programme is selected the display shows the time required to dry a full load, after around 10 minutes the controller calculates a better estimate of the cycle time.

The time to end is displayed in hours and minutes and counts down each minute.

The colon between the hours and minutes display flashes to show that the time is counting down.

The Display also shows if there is a problem with your dryer, if this occurs the display will show F followed by a fault code number, the four option lights and the pause light will also flash Orange (see *Troubleshooting*).

Choosing a Programme

1. Plug the dryer into the electrical socket.
 2. Sort your laundry according to fabric type (see *Laundry*).
 3. Open the door and make sure the filter is clean and in place and the water container is empty and in place (see *Maintenance*).
 4. Load the machine and make sure that the items are not in the way of the door seal. Close the door.
 5. If the ON/Off light is not lit; press the On/Off Button .
 6. Select the Programmes selection that corresponds with fabric being dried by checking the Programmes table (see *Programmes*) as well as the indications for each type of fabric (see *Laundry*).
 7. Where available, choose Sensor Dry  or Timed Dry  option pressing and releasing the corresponding button until the desired level or time is displayed.
- ! See programmes table, for more details.
8. Set a delay time and other options as necessary (see *The Display*).
 9. If you wish the buzzer to sound at the end of the programme, press the sound button . If you have selected the Crease Care option, this option is not available.
 10. Press the START button  to begin. The display will show the estimated time to end.
- During the drying programme, you can check on your laundry and take out the items that are dry while the others continue drying. When you close the door again, press

START in order to resume drying.

If you open the door to check your laundry you will extend the drying time as the heat pump compressor will not start until 5 minutes after you close the door and pressed the start Button (see *The Controls*).

11. During the last few minutes of Drying Programmes before the programme is completed, the final COOL TUMBLE phase  is entered (fabrics are cooled), this phase should always be allowed to complete.

12. To let you know that your programme is complete the buzzer will beep 3 times and the display shows **END** (Note: if the SOUND option was selected the buzzer beeps 3 times every 30 seconds for 5 minutes). Open the door, take your laundry out, clean the filter and replace it. Empty the water container and replace it (see *Maintenance*).

If the Crease Care  option has been selected and you do not take the clothes out immediately the clothes will tumble occasionally for 10 hours or until you open the door.

13. Switch dryer off using the On/Off button.

Standby mode

This tumble dryer, in compliance with new energy saving regulations, is fitted with an automatic standby system which is enabled after about 30 minutes if no activity is detected. Press and hold the On-Off button until the dryer reactivates.

Special Programmes

Easy Iron Programme

Easy Iron is a short 10 minute programme (8 minutes of heat followed by a 2 minutes cool tumble period) which fluffs the fibres of clothing that has been left in the same position/location for an extended period of time. The cycle relaxes the fibres and makes them easier to iron and fold.

! Easy Iron is not a drying programme and should not be used for wet articles of clothing.

For best results:

1. Do not load more than maximum capacity. These numbers refer to dry weight:

Fabric:	Max
Cotton and Cotton mix	2.5 kg
Synthetics	2
Denim	2

2. Unload the dryer immediately after the end of the drying cycle, hang, fold or iron the articles and put them away in the closet. Should this not be possible, repeat the cycle.

The Easy Iron effect varies from one fabric to the next. It works very well on traditional fabrics like Cotton or Cotton mix, and less well on acrylic fibres and on materials such as Tencel.®

Wool Programme

- This is a programme for tumble dryer safe garments marked with the symbol .
 - It can be used for load sizes up to 1 kg (approximately 3 sweaters).
 - We recommend that garments are turned inside out before drying.
 - Loads dried using this programme are usually ready to wear, but on some heavier garments the edges may be slightly damp. Allow these to dry naturally as over-drying could damage garments.
- ! Unlike other materials, the mechanism of wool shrinkage is irreversible; i.e. it will not stretch back to original size and shape.
- ! This program is not suitable for Acrylic garments.

Jeans

- This is a programme for Jeans made from Denim Cotton. Before drying your Jeans turn the front pockets inside out.
 - It can be used for load sizes up to 3 kg (approximately 4 pairs).
 - It can also be used on other garments made from same material such as jackets.
 - Loads dried using this programme are usually ready to wear; the edges or seams may be slightly damp. If this is found try turning the jeans inside out and running the programme again for a short period.
 - The duration of this programme will depend on the size of the load, the dryness setting selected and the spin speed used in your washer.
 - Use this cycle only for a 100% cotton load, do not mix dark and light coloured items. Do not use this cycle for garments with embroidery and accessories (pins,...), turn the pockets insideout
- ! We do not recommend that you use this programme if your jeans have elastic waist bands or embroidery.

Special Programmes

Shirts

High Heat option

- This is a programme for Shirts made from Cotton.
- It can be used for load sizes up to 3 kg (approximately 12 shirts).
- Loads dried using this programme are usually ready to wear; the edges or seams may be slightly damp. If this is found try turning the shirts inside out and running the programme again for a short period.
- The duration of this programme will depend on the size of the load, the dryness setting selected and the spin speed used in your washer.

Low Heat option

- This is a programme for Shirts made from synthetic materials or a mixture of natural and synthetic materials such as Polyester and Cotton.
- It can be used for load sizes up to 3 kg (approximately 12 shirts).
- Loads dried using this programme are usually ready to wear; the edges or seams may be slightly damp. If this is found try turning the shirts inside out and running the programme again for a short period.

Note: The duration of this programme will depend on the size of the load, the dryness setting selected and the spin speed used in your washer.

Silk

- This is a programme for drying your Delicate Silk.
- It can be used for load sizes up to 0.5 kg.
- Loads dried using this programme are usually ready to use, but on some heavier garments the edges may be slightly damp. If this is found try removing the load and open them out then run the programme again for a short period.
- Only for garments labelled suitable for tumble drying.
- The duration of this programme will depend on the size of the load, the dryness setting selected and the spin speed used in your washer.

Duvet programmes

! Take care with these programme do not dry any items that are damaged which could result in the filling blocking the filter and air path resulting in a fire hazard.

- Must only be used on Single size duvets not suitable for double or king size items.
- Loads dried using this programme are usually ready to use, but may be slightly damp in places. If this is found try removing the load and open them out and shake then run the programme again for a short period.
- Also suitable for down filled jackets.

Note: The duration of this programme will depend on the size of the load, the dryness setting selected and the spin speed used in your washer.

Duvet - High Heat option

- This is a programme for drying your Cotton Duvets. With Cotton outer cover and down filling.
- Only for garments labelled suitable for tumble drying.

Duvet - Low Heat option

- This is a programme for drying your Synthetic Duvets, with synthetic filling.
- Only for garments labelled suitable for tumble drying.

Baby Delicate

- This is a programme for drying your baby's small delicate items of clothing and bedding (Cotton and Chenille) and for drying your Delicate Clothes.
- Do not dry items such as bibs and nappy pants with plastic coverings.
- It can be used for load sizes up to 2 kg.
- Loads dried using this programme are usually ready to use, but on some heavier garments the edges may be slightly damp. If this is found try turning them inside out and running the programme again for a short period.
- The duration of this programme will depend on the size of the load, the dryness setting selected and the spin speed used in your washer.

Bed & Bath

- This is a programme for Cotton Towels and sheets.
- It can be used for load sizes up to 9 kg.
- Loads dried using this programme are usually ready to use; the edges or seams may be slightly damp especially on large items. If this is found try opening them out and running the programme again for a short period.
- The duration of this programme will depend on the size of the load, the dryness setting selected and the spin speed used in your washer.

Refresh

Thanks to a cool air flow, oxygen penetrates the fibers and transports unpleasant odors such as cigarette smoke, frying, smog out of the clothes. With this short program, you can easily refresh your garments in just 20 minutes.

! Airing is not a drying programme and should not be used for wet articles of clothing.

- It can be used on any load size up to 9 kg, but is more effective on smaller loads.

20-minute programme that airs your clothes with cool air. Use also to cool warm clothes.

Anti Allergy

• The programme has the 'Seal of Approval' endorsement from 'Allergy UK', which reflects the effective reduction and elimination of allergens from the clothes. With this programme, thanks to the achievement of constant temperature for an extended period of time, the effects of the most common allergens (including House Dust Mite and Pollen) are neutralized.

Can be used on wet load to dry and treat or on a dry load just to treat your laundry.

Maximum load is 9 kg for a wet load and 4 kg for a dry load.

- The duration of this programme will depend on the size of the load, the dryness setting selected and the spin speed used in your washer.
-

Quick Dry

• Your drying time for small loads is very much reduced with a huge time saving up to 53% on cottons (with High Heat option) and 50% on synthetics (with Low Heat option).

Load: 1 Kg. Dryness level: only Cupboard Dry

Activewear

• This programme is specific for drying water-repellent fabrics and sports jackets (e.g. Gore-Tex, polyester, nylon). Drying the garment after a wash cycle has a beneficial effect as it reactivates the garment's water-repellent treatment.

It can be used for loads of up to 2 kg. Dryness level: only Cupboard Dry

- The duration of this programme will depend on the size of the load, the dryness setting selected and the spin speed used in your washer.
-

Heat & Enjoy

• The Heat & Enjoy cycle helps to heat towels & bathrobes for a warm sensation after a bath or a shower. It is also useful for warming clothes before dressing during winter.

The cycle heats the clothes up to 37° (the body temperature) and keeps the same temperature for a maximum of 4 hours or until the user stops the cycle by opening the door.

Load: 3 Kg.

! **Note:** during this programme the Sensing Icon  on the Display unit flashes.

Dark Cycle































































































































This programme helps to maintain the your Dark coloured clothes, by controlling the motor speed and drum rotation together with control of the lower drying temperature.

• It can be used on cottons and jeans load size up to maximum of 3 kg, but is more effective on smaller loads.

- The duration of this programme will depend on the size of the load, the dryness setting selected and the spin speed used in your washer.

Programmes Table

! If the On/Off light is not lit; Press the On/Off Button  and then select programme.

Programme	What it does	How to set it	Notes / Options available
 Easy Iron	Brief programme (approximately 10 minutes) that softens fibres of clothing that is ready for ironing.	<ol style="list-style-type: none"> 1. Position the PROGRAMME knob on . 2. Select Alarm Option if required. 3. Press the Start Button . 	! This is not a drying programme (see previous page). Options available Sound  .
 Refresh	20 min cool programme to air your clothes	<ol style="list-style-type: none"> 1. Position the PROGRAMME knob on . 2. Select Alarm Option if required. 3. Press the Start Button . 	Sound  .
 Cottons	Dries: your Cotton clothes. N.B: Max. load 6 kg (with Low Heat option)	<ol style="list-style-type: none"> 1. Position the PROGRAMME knob on . 2. Choose Sensor Dry  or Timed Dry  (see next page). 3. Select any Options if required. 4. Press the Start Button . 	Sound  or Crease care  . Delay Start  . High Heat  . Less Fluff  . Sensor Dry option, automatic drying: Damp dry  , Iron dry  , Hanger Plus  , Hanger dry  , Light dry  , Cupboard dry  , Ready to Wear  .
 Shirts	Dries your shirt.	<ol style="list-style-type: none"> 1. Position the PROGRAMME knob on . 2. Choose Sensor Dry  or Timed Dry  (see next page). 3. Select any Options if required. 4. Press the Start Button . 	Sound  or Crease care  . Delay Start  . High Heat  . Less Fluff  . Sensor Dry option, automatic drying: Damp dry  , Iron dry  , Hanger Plus  , Hanger dry  , Light dry  , Cupboard dry  .
 Jeans	Dries denim clothes.	<ol style="list-style-type: none"> 1. Position the PROGRAMME knob on . 2. Choose Sensor Dry  (see next page). 3. Select any Options if required. 4. Press the Start Button . 	Sound  or Crease care  . Delay Start  . Sensor Dry option, automatic drying: Damp dry  , Iron dry  , Hanger Plus  , Hanger dry  , Light dry  , Cupboard dry  , Ready to Wear  . (We suggest to use only Ready to Wear).
 Synthetics	Dries: your synthetics clothes.	<ol style="list-style-type: none"> 1. Position the PROGRAMME knob on . 2. Choose Sensor Dry  or Timed Dry  (see next page). 3. Select any Options if required. 4. Press the Start Button . 	Sound  or Crease care  . Delay Start  . Sensor Dry option, automatic drying: Damp dry  , Iron dry  , Hanger Plus  , Hanger dry  , Light dry  , Cupboard dry  .
 Bed & Bath	Dries your Towels and bedding.	<ol style="list-style-type: none"> 1. Position the PROGRAMME knob on . 2. Choose Sensor Dry  (see next page). 3. Select any Options if required. 4. Press the Start Button . 	Sound  or Crease care  . Delay Start  . Less Fluff  . Sensor Dry option, automatic drying: Damp dry  , Iron dry  , Hanger Plus  , Hanger dry  , Light dry  , Cupboard dry  , Ready to Wear  . (We suggest to use only Cupboard dry)
 Duvet	Dries your Duvet.	<ol style="list-style-type: none"> 1. Position the PROGRAMME knob on . 2. Select any Options if required. 3. Press the Start Button . 	Sound  or Crease care  . Delay Start  . High Heat  .
 Wool	Dries: your Woollen clothes.	<ol style="list-style-type: none"> 1. Position the PROGRAMME knob on . 2. Select any Options if required. 3. Press the Start Button . 	Sound  .
 Silk	Dries your silk items.	<ol style="list-style-type: none"> 1. Position the PROGRAMME knob on . 2. Choose Sensor Dry  (see next page). 3. Select any Options if required. 4. Press the Start Button . 	Sound  . Delay Start  . Sensor Dry option, automatic drying: Damp dry  , Iron dry  , Hanger Plus  , Hanger dry  , Light dry  , Cupboard dry  . (We suggest to use only Cupboard dry)
 Baby Delicate	Dries your baby clothes.	<ol style="list-style-type: none"> 1. Position the PROGRAMME knob on . 2. Choose Sensor Dry  or Timed Dry (see next page). 3. Select any Options if required. 4. Press the Start Button . 	Sound  or Crease care  . Delay Start  . Sensor Dry option, automatic drying: Damp dry  , Iron dry  , Hanger Plus  , Hanger dry  , Light dry  , Cupboard dry  . (We suggest to use only Cupboard dry)
 Anti Allergy	Anti Allergy treatment for your cotton clothes.	<ol style="list-style-type: none"> 1. Position the PROGRAMME knob on . 2. Select any Options if required. 3. Press the Start Button . 	Sound  or Crease care  . Delay Start  .

Programme	What it does	How to set it	Notes / Options available
 Dark Cicle	Dries your dark clothes.	<ol style="list-style-type: none"> 1. Position the PROGRAMME knob on . 2. Select any Options if required. 3. Press the Start Button > . 	Sound . Delay Start .
 Quick Dry	Dries your cotton or synthetic clothes in less time.	<ol style="list-style-type: none"> 1. Position the PROGRAMME knob on . 2. Select any Options if required. 3. Press the Start Button > . 	Sound . Delay Start . Crease care .
 Activewear	Dries your sports clothes.	<ol style="list-style-type: none"> 1. Position the PROGRAMME knob on . 2. Select any Options if required. 3. Press the Start Button > . 	Sound or Crease care . Delay Start .
 Heat & Enjoy	Heats your towel & bathrobe.	<ol style="list-style-type: none"> 1. Position the PROGRAMME knob on . 2. Select any Options if required. 3. Press the Start Button > . 	-

Sensor Drying and Timed Drying

First select a programme (see programmes table).

Programme	What it does	How to set it	Notes / Options available
Sensor Drying	<p>Always use Sensor Dry if possible for drying your clothes. It will guarantee you best drying results.</p> <p>The heat setting depends on the programme (material option) selected.</p>	<ol style="list-style-type: none"> 1. Press and release the sensor Dry button until the display shows the desired selection. Each press advances , , , , , and then repeats. ! Some sensing programmes do not have all 7 dryness level options. 2. Select any Options if required. 3. Press the Start Button > . 	<p>Options available</p> <p>Sound or Crease care . Delay Start .</p> <p>High Heat . Less Fluff .</p> <p>Consult suggested drying times (see Laundry).</p> <p>The last few minutes of these programmes is the cool tumble phase.</p>
Timed Drying (220, 180, 150, 120, 90, 60 or 40 minutes)	<p>Always use timed drying option if you want to decide the drying time.</p> <p>The heat setting depends on the Programme (material option) selected.</p>	<ol style="list-style-type: none"> 1. Press and release the Timed Button until the display shows the required selection. Each decreases time 220', 180', 150', 120', 90', 60', 40' and then repeats. <ul style="list-style-type: none"> • Baby Delicates have a maximum time of 150'. 2. Select any Options if required. 3. Press the Start Button > . 	<p>Options available</p> <p>Sound or Crease care . Delay Start . High Heat .</p> <p>Consult suggested drying times (see Laundry).</p> <p>The last few minutes of these programmes is the cool tumble phase.</p>

! For the best performance do not open the door before the cycle has finished.

The Controls

• Programme knob

! Warning, if after pressing the start button the programme knob position is changed, the new position will **NOT** change the programme selected.

To change programme press Start/Pause Button >|| to pause the programme, the light flashes Amber, select new programme and any option, the light will then flash green. Press the Start/Pause Button >|| and the new programme will start.

• Option Buttons/ Lights

These buttons are used to customise the selected programme to your requirements. Not all options are available for all programmes (see *Start and Programmes*). If an option is not available and you press the button, the buzzer will beep three times. If the option is available the option light next to the button lights to confirm the selection.

• ECO Light

This light is illuminated when you select programme options that will use less energy than the default setting. Examples are if you choose an Automatic or sensing programme or use a timed dry setting less than the default time. This light does not indicate that the optimum setting for energy use has been selected; it only shows you that your selected options will use less energy.

• Progress (☀️ Drying, 🌀 Cool tumble, END) Lights

The Progress lights show you the status of the programme. At each stage of the programme the corresponding light turns on.

• Delay Start 🕒

The start of some programmes (see *Start and Programmes*) can be delayed for up to 24 hours (see *The Display*). Ensure the water bottle is emptied and the filter is cleaned before setting a delayed start.

• Less Fluff 🧺

By reducing the mechanical action during the final drying stage the amount of lint and fluff produced is substantially reduced protecting the fibres of your garments.

• Sound 🔔

A buzzer sounds at the end of the drying cycle to signal that the programme has ended and the garments are ready to be removed. If you have selected the Crease Care option, this option is not available.

• Crease Care 🧺

When a delayed start and this option have been selected the clothes are tumbled occasionally during the delayed period to help prevent creases developing.

After end of the drying and cool tumble cycles, the clothes are occasionally tumbled to help prevent creases developing, should you not be available to remove the load immediately after the programme is complete. The **END** light is on during this phase after end of the cycle and the start/pause light flashes amber. If you have selected the Sound option, this option is not available.

• High Heat 🔥

When a drying time is selected, pressing this button sets a high heat drying and the indicator light above the button lights up.

• Empty Water Clean Filter Light "H2O" 🚰

(If you have plumbed your dryer to a drain the 🚰 light can be ignored for the water bottle, as there is no need to empty the water container). When 🚰 is on (not flashing) it reminds you to empty the water container. If the water container fills during a programme, the heater turns off and the dryer does

a period of Cool Tumble then the light flashes and the buzzer sounds. You must empty the container and restart the dryer or the clothes will not dry. After re-starting the dryer the light will take a few seconds to go out. To avoid this always empty the water container each time you use the dryer (see *Maintenance*).

! Please note that you ALWAYS have to clean the filter even if you have plumbed your dryer to a drain.

• Door Opening

Opening the door (or pressing the Start/Pause Button) during a programme will stop the dryer and have the following effects. Note: The Start/Pause Light flashes Amber during the Post Care phase of a programme.

- During a delay phase the delay will continue to count down. The start button must be pressed to resume the delay programme. One of the delay lights will flash to show the current delay setting.
- The start button must be pressed to resume the programme. The progress lights will change to show the current status and the Start/Pause light will stop flashing and turn green.
- During the post creasecare phase of a drying program, the Programme will finish. Pressing the Start/Pause button will restart a new program at the beginning.
 - Changing the Programmes knob will select a new programme and the Start/Pause Light will flash green. You can use this to select the "Refresh" programme to cool the clothes if you find them dry enough. Pressing the start/pause button to begin new Programme.
- **Heat Pump Protection System**
The heat pump system has a compressor protection feature, that operates if you open the door or there is a power disruption or you turn off the dryer. This system will prevent the heat pump compressor from starting for 5 minutes after the door is closed and the programme started.

• Note

If you have a power cut, switch off the power or remove the plug. When power is restored, plug in the machine, press and hold the ON/OFF button until the dryer reactivates, then press Start/Pause button.

Sorting your laundry

- Check symbols on clothing labels to make sure that the articles can be tumble dried.
- Sort laundry by fabric type.
- Empty pockets and check buttons.
- Close zippers and hooks and tie loose belts and strings.
- Wring out each item in order to eliminate as much excess water as possible.

! Do not load dripping wet clothes into the dryer.

Maximum load

Do not load more than maximum capacity. These numbers refer to dry weight:
 Natural fibres: 9 kg max (19,8 lb)
 Synthetic fibres: 3 kg max (6.6 lb)

! Do not overload the dryer as this could result in reduced drying performance.

Typical weights

Note: 1kg = 1000g; (1 lb = 16 oz.)

Clothes		
Blouse	Cotton	150g (5 oz)
	Other	100g (3 oz)
Dress	Cotton	500g (1lb 2 oz)
	Other	350g (12 oz)
Jeans		700 g (1 lb 6 oz)
10 Nappies		1000 g (2 lb 6 oz)
Shirt	Cotton	300g (10 oz)
	Other	200g (7 oz)
T - Shirt		125 g (4 oz)

Household items		
Duvet cover (Double)	Cotton	1500g (3 lb 5 oz)
	Other	1000g (2 lb 3 oz)
Large Tablecloth		700 g (1 lb 6 oz)
Small Tablecloth		250 g (9 oz)
Tea Towel		100 g (3 oz)
Bath Towel		700 g (1 lb 6 oz)
Hand Towel		350 g (12 oz)
Double Sheet		500 g (1 lb 2 oz)
Single Sheet		350 g (12 oz)

At the end of a drying cycle, cottons could still be damp if you grouped cottons and synthetics together. If this happens simply give them an additional short period of drying.

Wash care labels

Look at the labels on your garments, especially when tumble drying for the first time. The following symbols are the most common:

- May be tumble dried.
- Do not tumble dry.
- Tumble dry at high heat setting.
- Tumble dry at low heat setting.

What not to tumble dry in your dryer:

- Articles that contain rubber or rubber-like materials, or plastic film (pillows, cushions, or PVC rainwear); any other flammable objects, or objects that contain flammable substances (towels soiled with hairspray).
- Glass fibres (certain types of draperies).
- Items that have been Dry Cleaned.
- Items with the ITLC code ("Special clothing items") . These can be cleaned with special at-home dry cleaning products. Follow instructions carefully.
- Large bulky items (pillows, cushions and large bedspreads. Sleeping bags and duvets can be dried using the Duvet programmes as described on page 8). These expand when drying and would prevent airflow through the dryer.



The wool drying cycle of this tumble drying machine has been tested and approved by The Woolmark Company. The cycle is suitable to dry wool garments which are

labeled "hand wash" provided that the garments are washed in a Woolmark endorsed hand washing cycle and tumble dried according to the instruction issued by the manufacturer. M0000
 In UK, Eire, Hong Kong and India the Woolmark symbol is a certification trademark.

©The Woolmark Company Pty Ltd.

Special clothing items

Blankets and bedspreads: acrylic items (Acilian, Courtelle, Orion, Dralon) must be dried with special care on a low heat setting. Avoid drying for a long period of time.

Pleated or creased garments: read manufacturer drying instructions on the garment.



Starched articles: do not dry these items with nonstarched items. Make sure that as much of the starch solution is removed from the load as possible before placing it in the dryer. Do not over-dry: the starch will become powdery and leave your clothing limp, which defeats the purpose of starch.

Drying times

Times are approximate and can vary depending upon:

- Amount of water retained in clothes after spin cycle: towels and delicates retain a lot of water.
- Fabrics: items that have the same type of fabric but different textures and thicknesses may not have the same drying times.
- Quantity of laundry: single items or small loads may take longer to dry.

Drying times

Cotton  High Heat		1 kg	2 kg	3 kg	4 kg	5 kg	6 kg	7 kg	8-9 kg
	Automatic minutes	40-60	60-90	90-100	100-130	130-150	150-170	170-180	180-220
	Timed	40 or 60	60 or 90	90 or 120	90 or 120	120 or 150	150 or 180	180	180 or 220
Drying times 800-1000 rpm in washing machine									
Synthetics  Low Heat		1 kg		2 kg		3 kg			
	Automatic minutes	40-50		50-60		60-90			
	Timed Dry setting	40 or 60		40 or 60		60 or 90			
Drying times on reduced spin in washing machine									
Acrylics (Delicates) Low Heat		1 kg			2kg				
	Automatic minutes				Timed dry only				
	Timed Dry setting	30			60				
Drying times on reduced spin in washing machine									

- Dryness: if you are going to iron some of your clothes, they can be taken out while still a bit damp. Others can be left longer if you need them to be completely dry.
- Heat setting.
- Room temperature: if the room where the dryer is located is cold, it will take longer for the dryer to dry your clothes.
- Bulk: some bulky items can be tumble dried with care. We suggest that you remove these items several times, shake them out, and return them to the dryer until finished.

! Do not over-dry your clothes.

All fabrics contain a little natural moisture, which keeps them soft and fluffy.

The table below presents APPROXIMATE drying times: the times given are for Cupboard Dry Automatic programmes. Timed dry settings are also shown, to help choosing a suitable time option.

Weights refer to dry garments.

Warnings and Suggestions

! This appliance has been designed and built according to international safety standards. These warnings are given for safety reasons and must be followed carefully.

General safety

- This tumble dryer is not intended for use by persons (including children) with reduced physical, sensory or mental capabilities, or lack of experience and knowledge, unless they have been given supervision or instruction concerning use of the appliance by a person responsible for their safety.
 - This tumble dryer has been designed for home, and not professional, use.
 - Do not touch the appliance while barefoot or with wet hands or feet.
 - Unplug the machine by pulling on the plug, not the cord.
 - Children must not be in proximity of the dryer when in use. After using the dryer, turn it off and unplug it. Keep the door closed to make sure that children do not use it as a toy.
 - Children should be supervised to ensure that they do not play with the dryer.
 - The appliance must be installed correctly and have proper ventilation. The air intake at the front of the dryer should never be obstructed (see *Installation*).
 - Never use the dryer on carpeting where the pile height would prevent air from entering the dryer from the base.
 - Check to see if the dryer is empty before loading it.
 -  The back of the dryer could become very hot. Never touch it while in use.
 - Do not use liquid fabric softeners in the dryer; add it to the final rinse of your wash.
 - Do not overload the dryer (see *Laundry for maximum loads*).
 - Do not load items that are dripping wet.
 - Carefully check all instructions on clothing labels (see *Laundry*).
 - Do not tumble dry large, very bulky items.
 - Do not tumble dry acrylic fibres at high temperatures.
 - Complete each programme with its cool tumble phase.
 - Do not turn off the dryer when there are still warm items inside.
 - Clean the filter after each use (see *Maintenance*).
 - Empty the Water Container after each use (see *Maintenance*).
 - Clean the Heat Pump filter unit at regular intervals (see *Maintenance*).
 - Do not allow lint to collect around the dryer.
 - Never climb on top of the dryer. It could result in damage.
 - Always follow electrical standards and requirements (see *Installation*).
 - Always buy original spare parts and accessories (see *Service*).
- ! **WARNING:** Never stop the dryer before the end of the drying cycle unless all items are quickly removed and spread out so that the heat is dissipated.

To minimise the risk of fire in your tumble dryer, the following should be observed:

- Tumble dry items only if they have been washed with detergent and water, rinsed and been through the spin cycle. It is a fire hazard to dry items that HAVE NOT been washed with water.
- Do not dry garments that have been treated with chemical products.
- Do not tumble dry items that have been spotted or soaked with vegetable or cooking oils, this constitutes a fire hazard. Oil-affected items can ignite spontaneously, especially when exposed to heat sources such as a tumble dryer. The items become warm, causing an oxidation reaction with the oil. Oxidation creates heat. If the heat cannot escape, items can become hot enough to catch fire. Piling, stacking or storing oil-affected items can prevent heat from escaping and so create a fire hazard. If it is unavoidable that fabrics containing vegetable or cooking oil or those that have been contaminated with hair care products be placed in a tumble dryer they should first be washed with extra detergent - this will reduce, but not eliminate the hazard. The cool tumble phase should be used to reduce the temperature of the items. They should not be removed from the dryer and piled or stacked while hot.
- Do not tumble dry items that have previously been cleaned in or washed in, soaked in or soiled with petrol/gasoline, dry cleaning solvents or other flammable or explosive substances. Highly flammable substances commonly used in domestic environments including cooking oil, acetone, denatured alcohol, kerosene, spot removers, turpentine, waxes and wax removers. Ensure these items have been washed in hot water with an extra amount of detergent before being dried in the tumble dryer.
- Do not tumble dry items containing foam rubber (also known as latex foam), or similarly textured rubber like materials. Foam rubber materials can, when heated, produce fire by spontaneous combustion.
- Fabric softener or similar products should not be used in a tumble dryer to eliminate the effects of static electricity unless the practice is specifically recommended by the manufacturer of the fabric softener product.
- Do not tumble dry undergarments that contain metal reinforcements eg. bras with metal reinforcing wires. Damage to the tumble dryer can result if the metal reinforcements come loose during drying.
- Do not tumble dry rubber, plastic articles such as shower caps or babies waterproof covers, polythene or paper.
- Do not tumble dry rubber backed articles, clothes fitted with foam rubber pads, pillows, galoshes and rubber coated tennis shoes.
- Remove all objects from pockets, especially lighters (risk of explosion).

Save energy and respect the environment

- Wring out all items to eliminate excess water before tumble drying (if you use a washing machine first, select a high spin cycle). Doing this will save time and energy during drying.
- Always dry full loads - you save energy: single items or small loads take longer to dry.
- Clean the filter after each use to contain energy consumption costs (see *Maintenance*).

Maintenance and Care

GB

Switching off the electricity

! Unplug the dryer when not using it, when cleaning it, and during maintenance activities.

Clean the filter after each cycle

The filter is an important part of your dryer: it accumulates lint and fluff that is formed while drying. When finished drying, clean the filter by rinsing it under running water or with your vacuum cleaner. Should the filter become clogged up, the airflow inside the dryer will be seriously compromised: drying times lengthen and you will consume more energy. It may also damage your dryer. The filter is found in front of the dryer trim (see diagram).

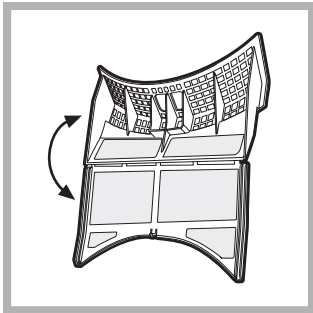

Removing the filter:

1. Pull the plastic grip of the filter upwards (see diagram).
2. Open the filter by depressing the clip.
3. Clean the lint from the inside of the filter, and replace it correctly. Ensure the filter is fully located flush into the tumble dryer trim.

! Do not use dryer without replacing the filter.

Check the drum after each cycle

Turn the drum manually in order to remove small items (handkerchiefs) that could have been left behind.

Cleaning the drum

! Do not use abrasives, steel wool or stainless steel cleaning agents to clean the drum.

A coloured film may start to appear on the stainless steel drum, this may be caused by a combination of water and, or cleaning agents such as fabric conditioner from the wash. This coloured film will not affect the dryer performance.

Empty the Water Container after each cycle

Pull the container out of the dryer and empty it into a sink or other suitable drain. Replace container securely.

Always check and empty the container before you start a new drying programme.

Cleaning the Heat Pump Filter Unit

- Periodically (every 5 drying cycles) remove Heat pump filter unit and clean any build up of fluff from the surface of the filter by rinsing it under running water or with your vacuum cleaner. We however recommend that you clean this filter after every drying cycle to optimize the dryers performance.

To remove Heat pump filter unit:

1. Unplug the dryer and open the door.
2. Remove the filter unit by rotating the 4 clips to the vertical position then pulling the filter unit towards you.
3. Separate the two parts of the filter unit and clean the surface of the filter.

! Warning: The front of the heat pump is made from thin metal plates.

Take care that you do not damage these or cut yourself when cleaning, removing or replacing the filter unit.

4. If there is any build up of fluff on the plates Carefully clean this off with a damp cloth, sponge or vacuum cleaner. Never use your Fingers.
5. Assemble the two parts of the filter clean the surface of the seals and replace with the 4 clips into the horizontal position, sure that the catches have been secured.

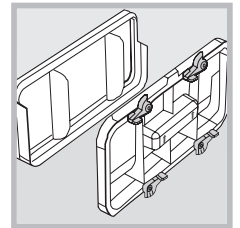

Cleaning the dryer

- External parts in metal or plastic and rubber parts can be cleaned with a damp cloth.
- Periodically (every 6 months) vacuum the front Air intake grille, to remove any build up of fluff, lint or dust. Also to remove accumulation of fluff from the front of Heat Pump filter unit and filter areas, clean occasionally with a vacuum cleaner.

! Do not use solvents or abrasives.

! Your dryer uses special bearing components which do not need lubrication.

! Have your dryer checked regularly by authorized technicians to ensure electrical and mechanical safety (see Service).

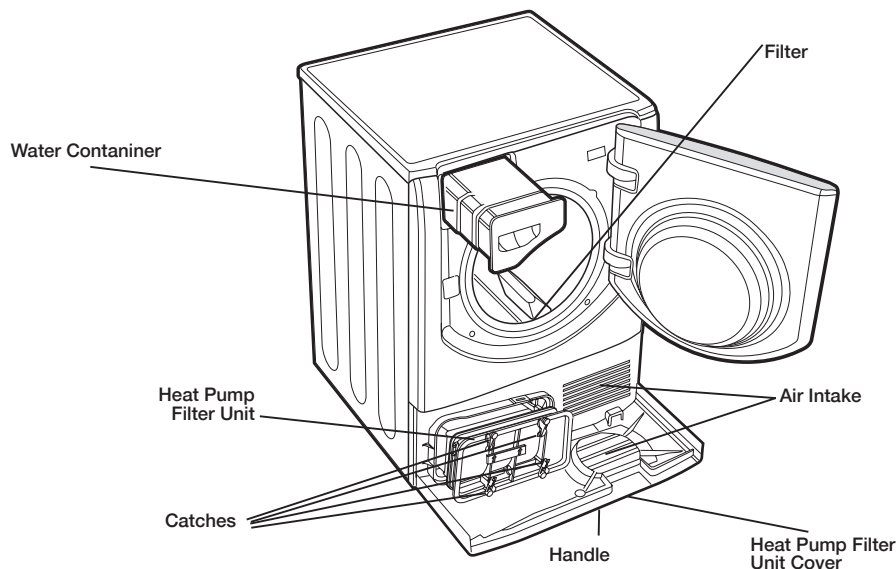

One day your dryer seems not to be working. Before you call your Service Centre (see *Service*), go through the following troubleshooting suggestions.

Problem:

The dryer won't start.

Possible causes / Solutions:

- The plug is not plugged into the socket, or not making contact.
- There has been a power failure.
- The fuse has blown. Try to plug another appliance into the socket.
- You are using an extension cord. Try to plug the dryer's power cord directly into the socket.
- The door is not closed securely.
- The programme has not been set properly (see *Start and Programmes*).
- The START button has not been pressed (see *Start and Programmes*).

Drying cycle will not begin.

- You have set a delay time (see *Start and Programmes*).
- You have pressed the start button; there will be a short delay before the dryer starts. Wait for drying to begin, do not press the start button again or the dryer will pause and not begin drying.

It is taking a long time to dry.

- The filter has not been cleaned (see *Maintenance*).
- The water container needs emptying? The empty water light is flashing and "H2O" message is displayed? (see *Maintenance*).
- The Heat Pump Filter needs cleaning (see *Maintenance*).
- The temperature setting is not ideal for the type of fabric you are drying (see *Start and Programmes, and Laundry*).
- The correct drying time has not been selected for this load (see *Laundry*).
- The air intake grille is obstructed (see *Installation and see Maintenance*).
- The items are too wet (see *Laundry*).
- The dryer is overloaded (see *Laundry*).

The Empty water light is flashing but the dryer has only been running for a short period.

- The water container was probably not emptied at the start of the programme. Do not wait for the empty water signal always check and empty the container before starting a new drying programme (see *Maintenance*).

Empty water light is on and the water container is not full.

- This is normal the empty water flashes when the container is full. If the light is on but not flashing it's just a reminder to empty the container (see *Start and Programmes*).

Programme finishes and clothes damper than expected.

- ! For safety the dryer has a maximum programme time of 4 hours. If an automatic programme has not sensed the required final moisture in this time the dryer will complete the programme and stop. Check the above points and run the programme again, if the results are still too damp, contact the service centre (see *Service*).

The Display shows a fault code F followed by one or two numbers, the option lights and pause light are flashing.

- If the display shows F followed by one or two numbers, Turn off and remove plug, Clean the Filters (see *Maintenance*). Then replace plug turn on and start another program. If the number is displayed again Note down the number and contact the service centre (see *Service*).

The display briefly shows "dOn" every 6 seconds.

- The dryer is in 'Demo' mode. Press and hold both the On/Off and Start/Pause buttons for 3 seconds. The display will show "dOn" for 3 seconds and then the dryer will resume normal operation.

Time to End display changes during drying.

- The time to end is continuously monitored throughout the drying cycle and the time is adjusted to give the best-estimated time. The displayed time may increase during the cycle and this is normal.

The dryer makes a thumping noise during the first few minutes of operation.

- This is normal, particularly if the dryer has not been used for a while. If the noise persists throughout the whole drying cycle then contact the service centre.

The lights on the dryer control panel are off although the dryer is switched on.

- The dryer has gone into standby mode to save power. This occurs if you have left the dryer on or have had a power cut. It occurs after 30 minutes:
 - if you leave the dryer without starting a programme;
 - after your drying programme has finished.Press and hold the ON/OFF button until the dryer reactivates

Service

GB

Heat Pump System

This dryer is fitted with a sealed heat pump system to dry your clothes. To operate, the heat pump contains fluorinated greenhouse gases (F gases) which are covered by the Kyoto Protocol. These F gases are contained in a hermetically sealed unit. This sealed unit contains 0.29 kg of the F gas R134a which acts as a refrigerant.

If the sealed unit fails then it must be replaced by a new sealed unit. Contact your nearest service centre for advise.

Note: The gases contained in the sealed unit are not hazardous to health, but if they escape they will have an impact on global warming.

Before calling the Service Centre:

- Use the troubleshooting guide to see if you can solve the problem yourself (see *Troubleshooting*).
- If not, turn off the dryer and call the Service Centre closest to you.

What to tell the Service Centre:

- Name, address, and post code;
- telephone number;
- the type of problem;
- the date of purchase;
- the appliance model (Mod.);
- the dryer serial number (S/N).

This information can be found on the data label inside the door of the machine.

Spare Parts







This dryer is a complex machine. Repairing it yourself or having a nonauthorised person try to repair it could cause harm to one or more persons and to the machine, and could invalidate the spare parts warranty.

Call an authorised technician if you experience problems while using the machine.

Please note that it is an offence for an unqualified person to undertake any servicing or repair work that involves breaking into the sealed heat pump unit.

Comparative Programmes

- Programmes recommended for comparative test to EN61121.

Programme (EN61121)	Programme to select	Load size	Sensor Dry Option
Dry cotton	Cottons High Heat	 9 kg	 Cupboard Dry
Iron dry cotton	Cottons High Heat	 9 kg	 Iron
Easy-care textile	Synthetics	 3 kg	 Cupboard Dry

! Note: This is not a full list of programme options (see *Start and Programmes*).

Recycling and Disposal information

As part of our continued commitment to helping the environment, we reserve the right to use quality recycled components to keep down customer costs and minimise material wastage.

- Disposal of packaging materials: follow local regulations, so that packaging can be recycled.
- To minimise risk of injury to children, remove the door and plug - then cut off mains cable, flush with the appliance. Dispose of these parts separately to ensure that the appliance can no longer be plugged into a mains socket.

Disposal of old electrical appliances



The European Directive 2002/96/EC on Waste Electrical and Electronic Equipment (WEEE), requires that old household electrical appliances must not be disposed of in the normal unsorted municipal waste stream.

Old appliances must be collected separately in order to optimise the recovery and recycling of the materials they contain and reduce the impact on human health and the environment.

This dryer has as a sealed heat pump unit containing F gases which must be recovered and destroyed.

The crossed out "wheeled bin" symbol on the product reminds you of your obligation, that when you dispose of the appliance it must be separately collected.

Consumers should contact their local authority or retailer for information concerning the correct disposal of their old appliance.

(In UK this is your Civic Amenity Household Waste Recycling Centre).



This appliance conforms to the following EC Directives:

- 2006/95/EC (Low Voltage Equipment);
- 89/336/EEC, 92/31/EEC, 93/68/EEC (Electromagnetic Compatibility).



Guarantee

12 months Parts and Labour Guarantee

Your appliance has the benefit of our manufacturers' guarantee, which covers the cost of breakdown repairs for twelve months from the date of purchase.

This gives you the reassurance that if, within that time, your appliance is proven to be defective because of either workmanship or materials, we will, at our discretion, either repair or replace the appliance at no cost to you.

The guarantee is subject to the following conditions:

- The appliance has been installed and operated correctly and in accordance with our operating and maintenance instructions.
- The appliance is only used on the electricity or gas supply printed on the rating plate.
- The appliance has been used for normal domestic purposes only.
- The appliance has not been altered, serviced, maintained, dismantled or otherwise interfered with by any person not authorised by us.
- Any repair work must be undertaken by us or our appointed agent.
- Any parts removed during repair work or any appliance that is replaced become our property.
- The appliance is used in the United Kingdom or Republic of Ireland.

The guarantee does not cover:

- Damage resulting from transportation, improper use, neglect or interference or as a result of improper installation.
- Replacement of any consumable item or accessory. These include but are not limited to: plugs, cables, batteries, light bulbs, fluorescent tubes and starters, covers and filters.
- Replacement of any removable parts made of glass or plastic.

THE GUARANTEE WILL NOT APPLY IF THE APPLIANCE HAS BEEN USED IN COMMERCIAL OR NON-DOMESTIC PREMISES.

Non-Domestic Usage Policy:

Indesit Company manufactures appliances for domestic use only. We understand that in some cases our appliances are used in commercial and/or non-domestic situations. We still provide a full 12 month manufacturers' guarantee, provided the appliance has not been:

Accidentally damaged - Damage that occurs suddenly as a result of an unexpected and non-deliberate external action.

Maliciously damaged - The deliberate and intentional damage to the product.

Subjected to misuse - Incorrect or careless or improper use.

Subjected to overuse - Excessive usage versus that expected of a domestically situated appliance.

5 Year Parts Guarantee

Hotpoint also offers you a FREE 5 year parts guarantee. This additional guarantee is conditional on you registering your appliance with us and the parts being fitted by one of our authorised engineers. There will be a charge for our engineer's time.

To activate the extra parts warranty on your appliance, simply call our **free phone** registration line on

0800 519 2110 (Republic of Ireland 1800 844 347)



1950103992.00

09/2012

GB



Extended Guarantees

We offer a selection of protection plans that enable you to fully cover yourself against the expense of repair bills for the life of your policy. To find the ideal plan for you please call our advice line on

UK: 08448 226 226

Republic of Ireland: 01 230 0233

Free Helpdesk Service

We have a dedicated team who can provide free advice and assistance with your appliance if you experience any technical difficulties within the first 90 days of ownership. Simply call our Hotpoint Service Hotline on **08448 224 224 (Republic of Ireland 0818 313 413)** for telephone assistance, or, where necessary, to arrange for an engineer to call.

After Sales Service

No one is better placed to care for your Hotpoint appliance during the course of its working life than us - the manufacturer.

Essential Contact Information Hotpoint Service

We are the largest service team in the country offering you access to 400 skilled telephone advisors and 1100 fully qualified engineers on call to ensure you receive fast, reliable, local service.

UK: 08448 224 224

Republic of Ireland: 0818 313 413

www.hotpointservice.co.uk

Please note: Our advisors will require the following information:

Model number

Serial number

Parts and Accessories

We supply a full range of genuine replacement parts as well as accessory products that protect and hygienically clean your appliance to keep it looking good and functioning efficiently throughout its life.

UK: 08448 225 225

Republic of Ireland: 0818 313 413

www.hotpointservice.co.uk

Appliance Registration

We want to give you additional benefits of Hotpoint ownership. To activate your FREE 5 year parts guarantee you must register your appliance with us.

Free phone UK: 0800 519 2110

Republic of Ireland: 1800 844 347

www.hotpointservice.co.uk

Indesit Company UK Limited, Morley Way, Peterborough, PE2 9JB
Indesit Company, Unit 49 Airways Industrial Estate, Dublin 17