

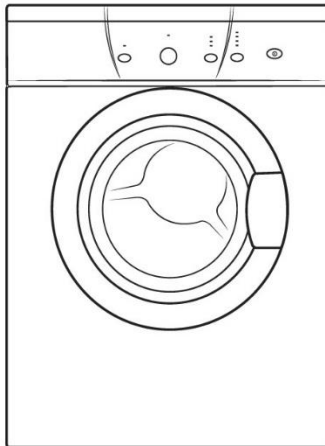

Russell Hobbs

7kg Vented Tumble Dryer

Instruction Manual



Model number(s):
RH7VTD500 (B) (R)

For Customer Services & Spare Parts please call **0345 208 8750**
Opening times: Monday - Friday 8am – 8pm & Saturday 9am – 1pm
or visit us at www.productcareuk.com

IMPORTANT:
RETAIN FOR FUTURE REFERENCE

Contents

Safety information	3 - 6
Before using your appliance	7
Control panel	8
Installation	9-10
Operating instructions	11 - 16
Care and maintenance	17
Trouble shooting	18-19
Technical specification	20
Product fiche	20
Connection to mains supply	21
Warranty	22
Notes	23



Russell Hobbs

For Customer Services & Spare Parts please call **0345 208 8750**
Opening times: Monday - Friday 8am – 8pm & Saturday 9am – 1pm
or visit us at www.productcareuk.com

Safety instructions

Important note:

Please read this booklet before installing and switching on this appliance. The manufacturer assumes no responsibility for incorrect installation and usage as described in this booklet.

- **This appliance can be used by children aged from 8 years and above and persons with reduced physical, sensory or mental capabilities or lack of experience and knowledge if they have been given supervision or instruction concerning use of the appliance in a safe way and understand the hazards involved. Children shall not play with the appliance.**
- Do not use an extension lead for this appliance. Only plug directly into a wall socket.
- Do not plug in damaged plug sockets.
- In case the power cable becomes damaged, contact **0345 208 8750** for advice.
- Never pull the cable when unplugging – always grip the plug itself.
- Do not plug-in or pull-out the plug from the receptacle with wet hands to prevent electric shock.
- Never touch the machine with wet hands or feet.
- Never force the door to open when the appliance is running.
- In case of any breakdown, unplug the appliance first and then turn the tap off. Do not attempt to repair by yourself, always contact **0345 208 8750** for advice.
- Remember that packaging materials of your machine may be dangerous for children.
- Keep the packaging materials in a place where children cannot reach or dispose of them appropriately.
- Do not allow your children to play with the washing machine as it is an electrically driven appliance.
- Keep your pets away from your machine.
- Your machine should only be used by adults in line with the information provided in this user's manual.
- Your machine is designed to be used domestically. Commercial use will cause your warranty to be cancelled.



Russell Hobbs

For Customer Services & Spare Parts please call **0345 208 8750**
Opening times: Monday - Friday 8am – 8pm & Saturday 9am – 1pm
or visit us at www.productcareuk.com

Safety instructions

- Any tampering with the machine, except by a qualified engineer, in any way, will cause your warranty to be invalid.
- Ideal ambient temperature of your machine is 15-30°C.
- Do not place your machine on carpet as this will block ventilation of the base.
- Do not keep inflammable liquids near your machine.
- Your machine is not covered under warranty for faults caused by any kind of external factors (pesticides, fire, etc.).

To avoid fire, electrical shock and other accidents, please remember the following:

To ensure your safety, an earthed power supply should be used.

- Only the voltage indicated in power label can be used. If you are not clear of the voltage at home, please contact your electricity supplier.
- Adequate ventilation must be provided around the tumble dryer.
- Exhaust air must not be discharged into a flue which is used for exhausting other fumes from appliances burning gas or other fuel.
- Please note it is not recommended that the dryer is placed directly next to ovens, cookers, or other heat sources as the performance of the dryer may be affected.
- A carpet must not obstruct the ventilation openings in the base of the dryer.
- Do not stack the tumble dryer on top of other appliances .
- Any electrical work required to install the appliance should be carried out by a qualified person.
- It is important to clean the lint filter after each drying cycle or the restrictions to airflow will extend drying times and could cause the safety cut-out to trip.



Russell Hobbs

For Customer Services & Spare Parts please call **0345 208 8750**
Opening times: Monday - Friday 8am – 8pm & Saturday 9am – 1pm
or visit us at www.productcareuk.com

Safety instructions

- Under no circumstances should anything other than the recommended articles be placed in the tumble dryer.
- The tumble dryer should be serviced by an appointed service team with genuine parts. Please contact the service team below for assistance with any repairs.
- It is dangerous to alter or modify the product in any way other than fitting authorized accessories.
- We recommend that the appliance is unplugged each time after use. It should always be disconnected from the electricity supply when not in use for long periods of time.
- The rear of the dryer gets quite hot during use. Position the dryer so that the back is not accessible while in operation, but ensure that the sides have a space available to allow airflow. Use the hose to assist with the ventilation.
- The special mains cable and plug assembly must only be replaced with a genuine part from the manufacturer, please contact the customer support team below.
- It is important to clean fluff from the window of the dryer and around the door seal after each drying cycle.
- Do not install the appliance close to a fire or heat source.
- Do not rest anything burning, such as a candle, on the appliance.
- Do not install the appliance in a damp environment, the dampness may cause damage to the tumble dryer.
- Do not install the tumble dryer in direct sunlight, or in a hot environment.
- Do not use the appliance to dry cushions, quilts, duvets, or similar items.
- Do not place items that have any type of oil soaked in to the fabric, in the tumble dryer. There is a potential the oil could catch on fire.



Russell Hobbs

For Customer Services & Spare Parts please call **0345 208 8750**
Opening times: Monday - Friday 8am – 8pm & Saturday 9am – 1pm
or visit us at www.productcareuk.com

Safety instructions

- Make sure items that may cause damage do not get in to the dryer, such as coins, safety pins, nails, screws, stones . Check the pockets on all the items of clothing.
- Check the appliance is not standing or pressing on the power cable.
- Foam rubber, latex, shower caps, waterproof textiles, rubber backed articles and any other items with foam rubber pads should not be dried in the tumble dryer.
- Always unplug the appliance after use, clean and maintain.
- Do not overload the appliance.
- Do not place clothes that are dripping wet in the tumble dryer..
- Clothes that have been in contact with volatile liquids should not be machine dried. Any fluid should be fully removed from the item before it can be dried.
- Do not dry unwashed items in the tumble dryer.
- The final part of a tumble drying cycle occurs without heat (cool down cycle) to ensure the items are not damaged. Do not stop the dryer before it has fully finished the drying cycle. This last approximately 3-4 minutes if the 'Anti-crease' remains un-selected.
- Do not use excessive, or high pressure water when cleaning the tumble dryer.



Russell Hobbs

For Customer Services & Spare Parts please call **0345 208 8750**
Opening times: Monday - Friday 8am – 8pm & Saturday 9am – 1pm
or visit us at www.productcareuk.com

Before using your appliance

Before installation, check that all parts are present. If any parts are missing, please contact the product care service team on: 0345 208 8750.

Feature Diagram

Note: The drawings in the book may vary from your dryer. They are designed to show the different features of all models covered by this book. Your model may not include all features.

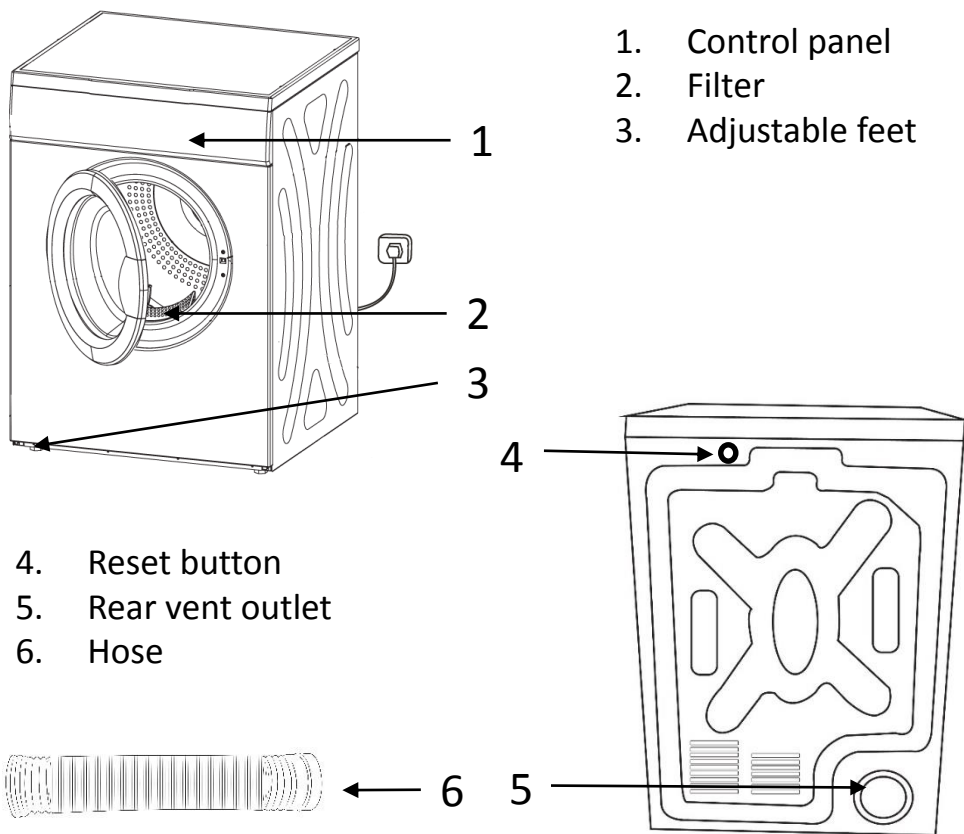

Russell Hobbs

For Customer Services & Spare Parts please call **0345 208 8750**
Opening times: Monday - Friday 8am – 8pm & Saturday 9am – 1pm
or visit us at www.productcareuk.com

Control Panel

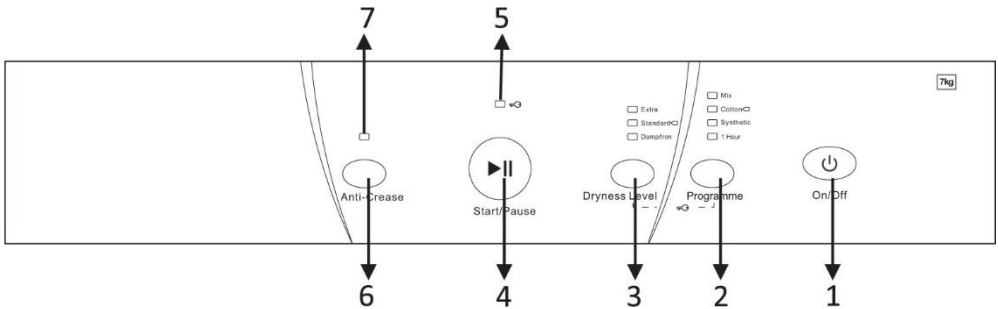

1. On/Off (see page 12)

Press the button to turn the dryer on and off

2. Programme button (see page 12 & 13)

Choose the correct programme for the load by selecting one of the four programmes.

3. Dryness level button (see page 13)

Choose the final dryness of the load by selecting the desired dryness setting.

4. Start/pause button (see page 14)

Press to start or pause the drying cycle.

5. Child lock indicator (see page 14)

When lit constantly it indicates that the child lock has been activated, no actions can be carried out until the child lock is de-activated

6. Anti-crease button (see page 14)

To reduce creasing of clothes.

7. Anti-crease indicator (see page 14)

When lit constantly it indicates that the anti-crease function has been activated.



For Customer Services & Spare Parts please call **0345 208 8750**
Opening times: Monday - Friday 8am – 8pm & Saturday 9am – 1pm
or visit us at www.productcareuk.com

Installation

For convenience, dryers are often positioned close to the washing machine, so the laundry can be easily transferred. The dryer should be placed in a ventilated area with at least a 10cm distance from the wall. It is recommended that there are no obstacles within 1.5m in front of dryer.

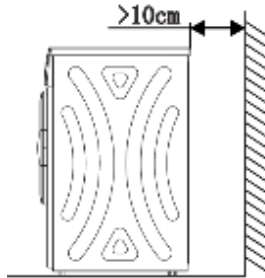

The tumble dryer will expel moist air, and it's recommended this is directed outside to avoid condensation accumulating inside a room. Position the vent hose supplied, through a window or an air outlet so that the moisture can escape. Contact a qualified tradesman to fit the vent hose so it exits through a wall or door.

Exhaust of humid air from the dryer into a room may damage the walls and furniture in the room.

Install the tumble dryer so that the plug remains accessible after installation. Do not block any vents on the dryer, as this will impair the working of the machine. It should be placed on a firm level surface, as this helps keep noise and vibration to a minimum. There should be no movement from the dryer. Adjust the feet underneath the dryer to make sure it is completely stable. Do not remove the feet from the dryer.

The hot air emitted from the tumble dryer can reach temperatures of 60°C, therefore, make sure the floor can handle these temperatures. The tumble dryer works best in a room between 15°C and 30°C.



For Customer Services & Spare Parts please call **0345 208 8750**
Opening times: Monday - Friday 8am – 8pm & Saturday 9am – 1pm
or visit us at www.productcareuk.com

Installation

Fitting the vent hose

One edge of the vent hose has a thread, this edge is to be aligned with the vent on the back of the appliance. When aligned, push and twist the end of the hose in a clockwise direction until the hose is attached securely.

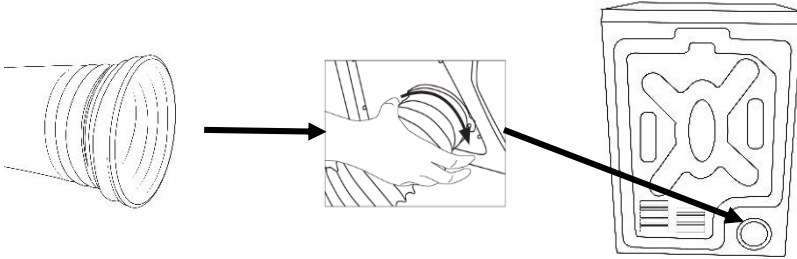

The air outlet hose must be extended directly to the outdoors.

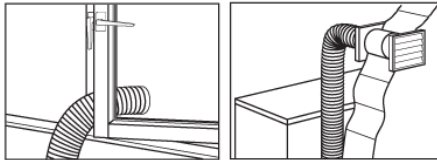

Do not allow more than two bends in the hose and end of the hose should not be bent, stepped on or folded between the drain and the machine. Moisture may accumulate in the hose, it may be useful to drill a small hole at a low point (indicated as B in the diagram below) to allow the moisture to escape.

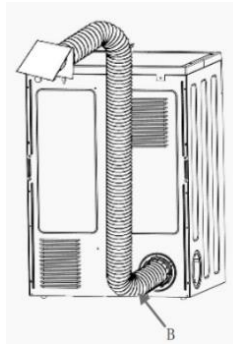

 Russell Hobbs

For Customer Services & Spare Parts please call **0345 208 8750**
Opening times: Monday - Friday 8am – 8pm & Saturday 9am – 1pm
or visit us at www.productcareuk.com

Operating Instructions

IMPORTANT NOTE - If you are drying laundry that weighs less than 1kg (small loads) when wet, then select the 1hr function to dry clothes.

Remove all the packaging material, including any material inside the drum. Before using the appliance for the first time, it is advised to place two damp clothing articles inside the drum and dry them for 1 hour. There may be some dust in the drum of the tumble dryer, and this will help remove the dust.

Step 1 - Open the door and place the laundry in the drum, one item at a time. Lightly shake and loosen the clothing to prevent it getting tangled.

Important note: Do not overload your dryer. The following table lists some common items and their approximate weight when wet, consider this when loading the dryer. Do not overload.

Quilt cover	700g	Shirt	600g
Sheet	500g	T-shirt	200g
Pillow case	200g	Blouse	100g
tablecloth	250g	Bathrobe	1200g
Napkin	100g	Night gown	200g
Bath towel	1200g	Pyjamas	500g
Tea towel	100g	Underwear	100g

Step 2 - Close the door, ensuring no items are trapped in the door.

Step 3 – Switch on the dryer and select the required programme (the selected programme indicator will light up).



For Customer Services & Spare Parts please call **0345 208 8750**
Opening times: Monday - Friday 8am – 8pm & Saturday 9am – 1pm
or visit us at www.productcareuk.com

Step 4 - Select the dryness level and press the Start/Pause button to start the drying cycle. The programme light will start flashing and the drum will begin rotating and will stop when the selected programme has finished. Each setting has the availability to add anti-crease to the cycle and to change the drying setting but these have to be selected prior to the drying cycle being confirmed (they cannot be added or changed mid-cycle).

To change a programme that has already started, cancel the first programme by pausing and turning the machine off, before turning the machine back on to select the desired programme.

If the door is opened during a cycle the dryer will stop. To restart, close the door and press the start/pause button.

When drying large items such as sheets, we suggest you periodically stop the dryer to redistribute the load.

There is an automatic cool down period at the end of every cycle, during which the heater is switched off. This helps to minimize creasing, and must always be used fully to avoid the risk of fire.

On/off

Press the button to turn the dryer on and off

Programmes

Press the button until the require programme is highlighted, There are 4 programmes and these are:

Cottons:

Types of laundry: Cottons, linens, delicates (a damp/iron dryness level **must be** selected when drying delicates).

Selectable dryness levels: extra, standard and damp/iron .



Russell Hobbs

For Customer Services & Spare Parts please call **0345 208 8750**
Opening times: Monday - Friday 8am – 8pm & Saturday 9am – 1pm
or visit us at www.productcareuk.com

Mixed

Types of laundry: If a mixture of fabrics and types of laundry that are to be dried together: cottons, synthetics, underwear, shirts, etc.

Selectable dryness levels: extra and standard only.

Synthetics

Types of laundry: Polyester, Acrylic, Nylon, Spandex, etc.

Selectable dryness levels: extra and standard only

1hr

Types of laundry: If you are drying laundry that weighs less than 1kg (small loads) when wet, then select the 1hr function to dry clothes

Selectable dryness levels: No dryness levels available

Dryness level

The dryness level must be selected prior to the drying cycle being started. The dryness level that is selected will be dependent on the programme that has been selected and the dryness level you require for your laundry. You must press the button until the required dryness level for your laundry is highlighted.

Extra – laundry will be dry enough to be put away (comparable to a high heat setting)

Standard – laundry clothes are slightly damp and ready to be ironed depending upon fabric, clothes are generally dry enough to be put away (comparable to a standard heat setting or a mid dry programme)

Damp/Iron – laundry will be slightly damp/damp and ready to be ironed (comparable to a low heat setting). This dryness level must be used when drying delicate clothing.

Time controlled drying (Time)

If you are drying laundry that weighs less than 1kg (small loads) when wet, then select the 1hr function to dry clothes.



Russell Hobbs

For Customer Services & Spare Parts please call **0345 208 8750**
Opening times: Monday - Friday 8am – 8pm & Saturday 9am – 1pm
or visit us at www.productcareuk.com

Child Lock

To use the child lock function you must hold the programmes and dryness level buttons at the same time for 4 seconds once a cycle has started. This will cause all orders to be ignored except the power on/off, until the child lock is removed by holding both buttons for a further 4 seconds.

Child lock indicator

When lit constantly it indicates that the child lock has been activated, no actions can be carried out until the child lock is de-activated

Start/Pause

This button must be pressed to start the dryer after selecting the desired programme. If the door of the dryer is opened during a cycle, the start/pause button must be pressed again to continue the cycle. At this point the light flashes to remind you that the start button needs to be pressed again.

Anti-crease

This button must be pressed prior to the drying cycle being started. This function will reduce creasing of clothes.

Anti-crease indicator

When lit constantly it indicates that the anti-crease function has been activated.

ALWAYS CLEAN THE FLUFF FILTER AFTER EACH USE. Failure to do so could cause the safety cut-out to operate.

Reversing the Door

The door cannot be reversed



Russell Hobbs

For Customer Services & Spare Parts please call **0345 208 8750**
Opening times: Monday - Friday 8am – 8pm & Saturday 9am – 1pm
or visit us at www.productcareuk.com

Programme table

Programmes	Clothing type	Capacity (KGs)	Approximate amount of remaining humidity	Dryness level	Approximate time (mins)	Comments
Cotton	Cottons, linens & delicates	7 / 3.5	70%	Extra	155 / 110	You must select the most suitable programme and dryness level according to the type and weight of your laundry
		7 / 3.5	60%	Standard	140 / 100	
		7 / 3.5		Damp/Iron	100 / 60	
Mix	A mixture of fabrics and types of laundry that are to be dried together: cottons, synthetics, underwear, shirts, etc.	7 / 3.5	70%	Extra	170 / 110	
		7 / 3.5	60%	Standard	150 / 100	
Synthetics	Polyester, Acrylic, Nylon, Spandex, etc.	3.5	50%	Extra	70 / 58	
		3.5	40%	Standard	60 / 48	
1hr	Laundry that weighs less than 1.0KG	1	-	-	60	

Important note: the times shown in the table are guidelines, the time of each programme will adjust according to the load that is being dried.







Russell Hobbs

For Customer Services & Spare Parts please call **0345 208 8750**
 Opening times: Monday - Friday 8am – 8pm & Saturday 9am – 1pm
 or visit us at www.productcareuk.com

Operating Instructions

- Never tumble dry the following; Delicate items such as net curtains, woollen items, silk items, items with metal trims, nylon tights, bulky items such as blankets, or sleeping bags, feather quilts and items containing or including rubber foam.
- Follow the instructions on the garment label;

	Tumble dry
	Normal dry
	Delicate drying
	Do Not tumble dry

- To prevent some items getting tangled, make sure zips, press studs, and hooks are closed, to try and prevent any tangling with other items.
- Do not over dry laundry, by not over drying it avoids creasing and saves energy.
- Avoid drying dark clothes with light coloured fluffy items, the fluff will be noticeable on the dark clothing.
- Make sure the laundry is thoroughly spun before tumble drying.



Russell Hobbs

For Customer Services & Spare Parts please call **0345 208 8750**
Opening times: Monday - Friday 8am – 8pm & Saturday 9am – 1pm
or visit us at www.productcareuk.com

Care and maintenance

ALWAYS CLEAN THE FILTER AFTER EACH USE. Failure to do so could cause the safety cut-out to operate.

- Pull the filter upwards from the appliance.

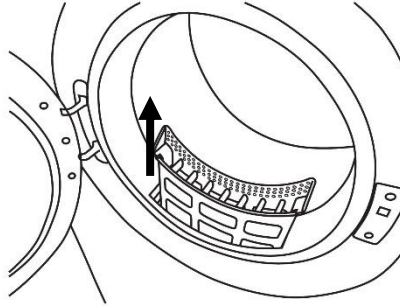

- Open the filter and remove any threads or fluff by hand or with a soft brush.

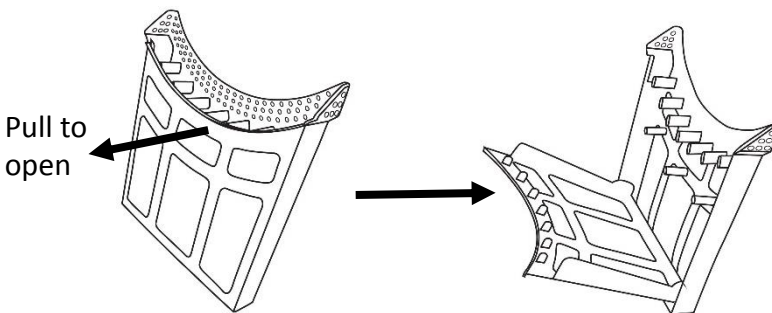

- Close the filter and slide it back into place.
- Wash the filter occasionally in detergent solution using a soft brush to remove small particles.
- If your filter becomes damaged, replace it to ensure no damage is caused to the dryer.



For Customer Services & Spare Parts please call **0345 208 8750**
Opening times: Monday - Friday 8am – 8pm & Saturday 9am – 1pm
or visit us at www.productcareuk.com

Trouble shooting

If the clothes are not dry after normal drying time:

- If you are drying laundry that weighs less than 1kg (small loads) when wet. Then the 1hr programme must be used.
- Check that you used the correct dryness level.
- Check that the lint/fluff filter has been cleaned. A blocked filter will restrict the airflow.
- Check that your dryer is heating - below the door to the left side, should feel warm to the touch after the first 10-15 minutes of its programme.

Failure to heat may indicate the safety cut-out has operated. To reset, simply press the reset button at the rear of the machine. If it has operated then a sharp “click” will be heard.

Reset button

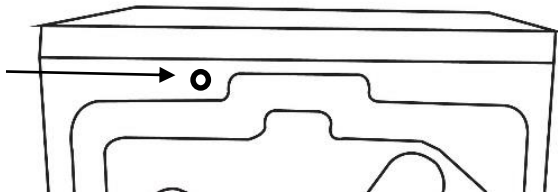

This cut-out only operates if the airflow is severely restricted so make sure the filter is clean, the air inlets and outlets at the front and back are not blocked, and that all other restrictions are removed before re-starting. If the cut-out continues to operate after checking the above points, you should contact Product Care on 0345 208 8750.

If your machine does not work check the following before calling a service engineer:

- Check that the machine has the correct weight load in the drum before starting the appliance.



Russell Hobbs

For Customer Services & Spare Parts please call **0345 208 8750**
Opening times: Monday - Friday 8am – 8pm & Saturday 9am – 1pm
or visit us at www.productcareuk.com

Trouble shooting

- Check that there is a supply of electricity or the machine is plugged in and the power switched on
- Check that the door has been properly closed and the machine is switched on (start button pressed, if fitted).
- The child lock has been activated.
- Check the fuse in the plug.

Laundry has shrunk, become felted or deteriorated.

- Programme suitable for the laundry type might have not been used.

Only dry laundry which is suitable for drying in your machine after checking the labels on your clothes. Also select a programme and dryness level suitable for the laundry type to dry your clothes.



Russell Hobbs

For Customer Services & Spare Parts please call **0345 208 8750**
Opening times: Monday - Friday 8am – 8pm & Saturday 9am – 1pm
or visit us at www.productcareuk.com

Technical Specification

Brand	Russell Hobbs
Model number	RH7VTD500 (B) (R)
Type	Vented dryer
Efficiency rating	C
Capacity (KGs)	7
Weight (KGs)	33.0
Dimensions (CMs):	(H)84.0 x (W)59.5 x (D)55.0

Product fiche

Energy consumption 510.0 kWh per year, based on 160 drying cycles of the standard cotton programme at full and partial load, and the consumption of the low-power modes. Actual energy consumption per cycle will depend on how the appliance is used.

Automatic or non-automatic: Automatic EU

Ecolabel: N/A Energy consumption of the standard cotton programme at full load: 4.38 kWh

Energy consumption of the standard cotton programme at partial load: 2.38 kWh

Power consumption of the off-mode (Po): 0.46 W

Power consumption of the left-on mode (Pl): 0.46 W

Duration of the left-on mode: 10 min

Cotton + Standard programme ,which is the "standard cotton programme" used at full and partial load ,is the standard drying programme to which the information in the label and the fiche relates, that this programme is suitable for drying normal wet cotton laundry and that it is the most efficient programme in terms of energy consumption for cotton.

Weighted programme time of the standard cotton programme at full and partial load:

100 min Programme time of the standard cotton programme at full load: 130 min

Programme time of the standard cotton programme at partial load: 74 min

Sound power level for the standard cotton programme at full load: 69dB



Russell Hobbs

For Customer Services & Spare Parts please call **0345 208 8750**
Opening times: Monday - Friday 8am – 8pm & Saturday 9am – 1pm
or visit us at www.productcareuk.com

Connection to the mains supply

For UK use only – Plug fitting details (where applicable):

As the colours of the wires in the mains lead of this appliance may not correspond with the coloured markings identifying the terminals in your plug, proceed as follows:

The GREEN/YELLOW wire is the EARTH and must be connected to the terminal which is marked with the letter E or by the earth symbol or coloured GREEN or GREEN/YELLOW.

The BLUE wire is the NEUTRAL and must be connected to the terminal marked with the letter N or coloured BLACK. The BROWN wire is the LIVE wire and must be connected to the terminal marked with the letter L or coloured RED.

Always ensure that the plug cord grip is fastened correctly.

If a 13A (BS1363) fused plug is used it must be fitted with a 13amp fuse conforming to BS1362 and be BSI or ASTA approved.



DANGER
Electric
Shock Risk

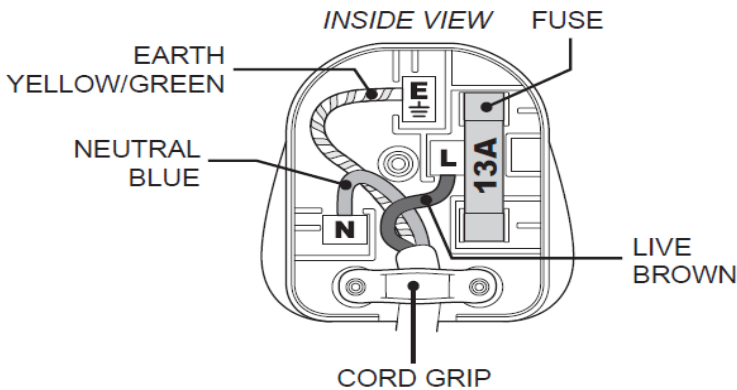

 Russell Hobbs

For Customer Services & Spare Parts please call **0345 208 8750**
Opening times: Monday - Friday 8am – 8pm & Saturday 9am – 1pm
or visit us at www.productcareuk.com

Warranty

This product is guaranteed for 12 months from the date of the original purchase. If any defect arises due to faulty materials or workmanship the faulty product must be returned to the place of purchase.

Refund or replacement is at the discretion of the retailer.

The following conditions apply:

- The product must be returned to the retailer with the original proof of purchase.
- The product must be installed and used in accordance with the instructions contained in this instruction guide and any other instructions for use which are supplied.
- It must be used for domestic purposes only and for its intended use.
- This warranty does not cover wear and tear, damage, misuse or consumable parts.

This does not affect your statutory rights.

Produced for:

G2S Limited

Wigan

WN2 4AY



Russell Hobbs

For Customer Services & Spare Parts please call **0345 208 8750**
Opening times: Monday - Friday 8am – 8pm & Saturday 9am – 1pm
or visit us at www.productcareuk.com

Notes:



Russell Hobbs

For Customer Services & Spare Parts please call **0345 208 8750**
Opening times: Monday - Friday 8am – 8pm & Saturday 9am – 1pm
or visit us at www.productcareuk.com

For Customer Services &
Spare Parts please call

0345 208 8750

Opening times:
Monday – Friday

8am – 8pm

&

Saturday

9am – 1pm

or visit us at

www.productcareuk.com

Revision 0.1



This symbol is known as the 'Crossed-out wheelee bin Symbol'. When this symbol is marked on a product/batteries, it means that the product/batteries should not be disposed of with your general household waste. Only discard electrical/electronic/battery items in separate collection schemes, which cater for the recovery and recycling of materials contained within. Your co-operation is vital to make sure the success of these schemes and for the protection of the environment. For your nearest disposal facility, visit www.recycle-more.co.uk or ask in store for details.

We reserve the right due to possible changes to design to alter the instruction manual without prior notice.

 Russell Hobbs

For Customer Services & Spare Parts please call **0345 208 8750**
Opening times: Monday - Friday 8am – 8pm & Saturday 9am – 1pm
or visit us at www.productcareuk.com