

Use and Installation Instructions

CH60GPCF
CH60PXF

This appliance must be installed in accordance with the regulations in force and only used in a well ventilated space.

Read these instructions before installing or using the appliance and retain them for future reference.

CONTENTS



	PAGE
Introduction	3
For Your Safety	4
Installation Instructions	6
Features	11
Control Panel	12
Oven Timer Operation	13
Hotplate	19
Grill	21
Main Oven	22
Main Oven Cooking Chart	23
The “Slow Cook” Setting	25
Top Oven	26
Top Oven Cooking Chart	27
Care and Cleaning	29
Something wrong with your Cooker?	32
Disposal of the appliance	33
Guarantee Information	34
Service Information	35

INTRODUCTION

To help you make the best use of your cooker, PLEASE READ THIS BOOKLET CAREFULLY.

Your new cooker is guaranteed and will give lasting service. The guarantee is only applicable if the cooker has been installed in accordance with the Installation Instructions.

The cooker is designed specifically for domestic use and responsibility will not be accepted for use in any other installation.

When first using the cooker ensure that the room is well ventilated (e.g. open a window or use an extractor fan) and that persons who may be sensitive to the odour avoid any fumes. It is suggested that any pets be removed from the room until the smell has ceased. This odour is due to any temporary finish and also any moisture absorbed by the insulation.

Our policy is one of continual improvement in design and development, therefore strict accuracy of illustrations and descriptions cannot be guaranteed.



This appliance conforms to the following EEC directives:

- 2006/95/EC of 12/12/06 (Low Voltage) and subsequent modifications;
- 2004/108/EC of 15/12/04 (Electromagnetic Compatibility) and subsequent modifications;
- 90/396/EEC of 29/06/90 (Gas) and subsequent modifications (only for models which use gas);
- 93/68/EEC of 22/07/93 and subsequent modifications.
- 2002/96/EC

ENERGY LABEL and ECODESIGN

Regulation (EU) No 65/2014 supplementing Directive 2010/30/EU.

Regulation (EU) No 66/2014 implementing Directive 2009/125/EC.

Standard EN 15181.

Standard EN 30-2-1

Please read the precautions below before using your cooker.

ALWAYS . . .

- ALWAYS make sure you understand the controls before using the cooker.
 - ALWAYS check that all controls on the cooker are turned off after use.
 - ALWAYS stand back when opening an oven door to allow heat to disperse.
 - ALWAYS use dry, good quality oven gloves when removing items from the ovens.
 - ALWAYS take care when removing items from the top oven/grill when the main oven is on, as the contents may be hot.
 - ALWAYS keep the oven and grill doors closed when the cooker is not in use.
 - ALWAYS place pans centrally over the hotplate burners and position them so that the handles cannot accidentally be caught or knocked or become heated by other burners.
 - ALWAYS keep the cooker clean, as a build up of grease or fat from cooking can cause a fire.
 - ALWAYS allow the cooker to cool before cleaning.
 - ALWAYS follow the basic principles of food handling and hygiene to prevent the possibility of bacterial growth.
 - ALWAYS keep ventilation slots clear of obstructions.
 - ALWAYS turn off the electricity supply before cleaning or replacing an oven lamp.
 - ALWAYS refer servicing to Gas Safe registered appliance service engineers.
- The appliance should not be operated by people (including children) with reduced physical, sensory or mental capacities, by inexperienced individuals or by anyone who is not familiar with the product. These individuals should, at the very least, be supervised by someone who assumes responsibility for their safety or receive preliminary instructions relating to the operation of the appliance.
 - **The appliance must be used by adults only for the preparation of food, in accordance with the instructions outlined in this booklet. Any other use of the appliance (e.g. for heating the room) constitutes improper use and is dangerous. The manufacturer may not be held liable for any damage resulting from improper, incorrect and unreasonable use of the appliance.**

FOR YOUR SAFETY

NEVER . . .

- NEVER leave children unsupervised where the cooker is installed as all surfaces will get hot during and after use.
- NEVER allow anyone to sit or stand on any part of the cooker.
- NEVER store items that children may attempt to reach above the cooker.
- NEVER heat up unopened food containers as pressure can build up causing the container to burst.
- NEVER store chemicals, food stuffs, pressurised containers in or on the cooker, or in cabinets immediately above or next to the cooker.
- NEVER fill a deep fat frying pan more than 1/3 full of oil, and never use a lid. **DO NOT LEAVE UNATTENDED WHILE COOKING.**
- NEVER place flammable or plastic items on or near the hotplate.
- NEVER use proprietary spillage collectors on the hotplate.
- NEVER use the cooker as a room heater.
- NEVER dry clothes or place other items over or near to the hotplate or oven/grill doors.
- NEVER wear garments with long flowing sleeves whilst cooking.

NOTE: The use of a gas cooking appliance results in the production of heat and moisture in the room in which it is installed. Always ensure that the kitchen is well ventilated; keep natural ventilation holes open or install a mechanical ventilation device (mechanical extractor hood).

In particular when using the grill or more than one hotplate burner, open a window if a mechanical ventilation device is not operating.

! The appliance should not be operated by people (including children) with reduced physical, sensory or mental capacities, by inexperienced individuals or by anyone who is not familiar with the product. These individuals should, at the very least, be supervised by someone who assumes responsibility for their safety or receive preliminary instructions relating to the operation of the appliance.

NOTICE

! VERY HOT SURFACES

FOOD OR GREASE ON THESE SURFACES COULD CAUSE SMOKE AND POSSIBLY EVEN BURN
YOU MUST KEEP THE OVEN AND GRILL CAVITIES CLEAN

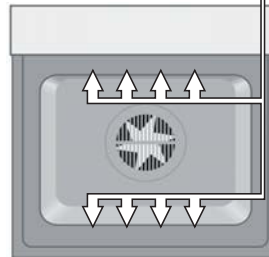

! ATTENTION

DURING INSTALLATION THE FEET OF THE APPLIANCE MUST BE LOWERED SO THAT AN AIR GAP OF AT LEAST 10MM (1CM) IS LEFT BETWEEN THE BASE OF THE APPLIANCE AND THE FLOOR.



! ATTENTION

WHEN USING THE MAIN OVEN YOU MUST ENSURE THAT THE BASE OF THE CAVITY IS NOT COVERED WITH ALUMINUM FOIL, UTENSIL OR ANY OTHER FORM OF COVERING. FAILURE TO DO THIS MAY RESULT IN THE CAVITY BEING DAMAGED.

INSTALLATION INSTRUCTIONS



Prior to installation, ensure that the local distribution conditions (nature of the gas and gas pressure) and the adjustment conditions are compatible. The adjustment conditions for this appliance are stated on the data badge which is fitted on the back panel. This appliance is not designed to be connected to a combustion products evacuation device. It must be installed and connected in accordance with current installation regulations. Particular attention should be given to the relevant requirements regarding ventilation.

MODEL NUMBERS CH60GPCF; CH60GPXF

Category II2H3+ (GB)

These models are set to burn NATURAL GAS (G20) at 20 mbar but can be converted for use on BUTANE (G30) at 28-30mbar or PROPANE (G31) at 37mbar with the use of the LPG conversion kit that can be obtained free of charge, if you contact our Genuine Parts and Accessories department (see Key Contacts, back page).

GAS SAFETY (INSTALLATION & USE) REGULATIONS

It is the law that all gas appliances are installed by competent persons in accordance with the current edition of the above regulations. It is in your interest and that of safety to ensure compliance with the law.

In the UK, Gas Safe registered installers work to safe standards of practice. The cooker must also be installed in accordance with BS 6172. Failure to install the cooker correctly could invalidate the warranty liability claims and could lead to prosecution.

LOCATION

The cooker may be located in a kitchen, kitchen/diner or a bed-sitting room, but not in a room containing a bath or shower. The cooker must not be installed in a bed-sitting room of less than 20m³.

When adjusted for use on Butane (G30) or Propane (G31), the cooker must not be installed in a room or internal space below ground level, e.g. in a basement.

PROVISION FOR VENTILATION

The room containing the cooker should have an air supply in accordance with BS 5440: Part 2.

The room must have an opening window or equivalent; some rooms may also require a permanent vent. If the room has a volume between 5 and 10m³, it will require an air vent of 50cm² effective area unless it has a door which opens directly to outside. If the room has a volume of less than 5m³, it will require an air vent of 100cm² effective area. If there are other fuel burning appliances in the same room, BS 5440: Part 2 should be consulted to determine air vent requirements.

TECHNICAL DATA

Gas connection	Rp ½ (½" BSP female)
Pressure test point	Front left hotplate injector
Gas rate adjustment	None
Aeration adjustment	None
Electrical connection	Flexible cord fitted with a 3 pin 13 amp plug 230/240V a.c. 50Hz. 13A fuse.

	G20 at 20mbar		G30 at 28-30mbar G31 at 37mbar	
	HEAT INPUT	INJECTOR	HEAT INPUT	INJECTOR
BURNER				
HOTPLATE Front Left	4.1 kW	100 + 72 + 100	3.8 kW (275g/h)	63 + 42 + 63
HOTPLATE Rear Right	3.05 kW	116	3.0 kW (220g/h)	86
HOTPLATE Rear Right and Rear Left	2.0 kW	103	2.0 kW (145g/h)	70
Grill	3.7 kW	150 (X)	3.4 kW (245g/h)	91
Main Oven	2.5 kW	115	2.3 kW (165g/h)	71
Top Oven	1.9 kW	100	1.9 kW (135g/h)	66

PLEASE PHONE US TO REGISTER YOUR APPLIANCE AND ACTIVATE YOUR PARTS GUARANTEE ON 08448 24 24 24

INSTALLATION INSTRUCTIONS

SPACE FOR FIXING

The cooker can be close fitted below hotplate level. This requires a minimum distance of 600mm between cupboard units of hotplate height. When installing next to a tall cupboard, partition or wall, for a minimum distance of 400mm above hotplate level, allow a side clearance of at least 65mm.

The diagram below illustrates the minimum clearance between the cooker and adjacent walls, cupboards etc.

The wall behind the cooker, 50mm below and 450mm above, and the width of the cooker, must be a non-combustible material such as ceramic wall tiles.

If the cooker is to be fitted close to a corner on the left hand side, ensure that there is a clearance of at least 50mm to allow the main oven door to open fully for when removing oven shelves.

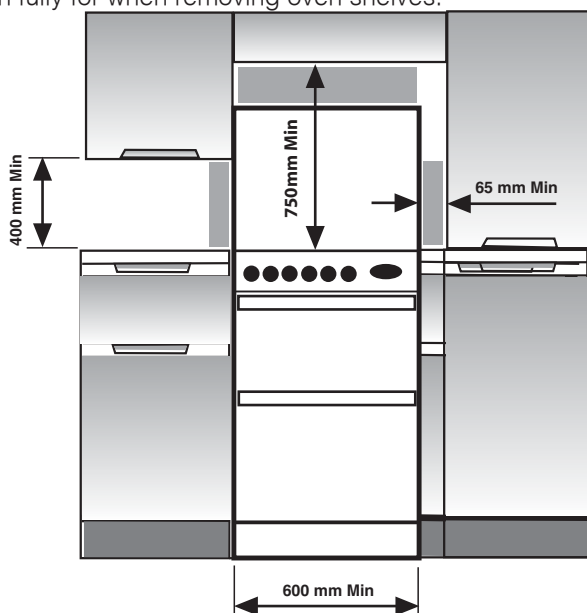

COOKER HOODS

If a cooker hood is to be installed, refer to the cooker hood manufacturers' instructions regarding fixing height.

UNPACKING THE COOKER

Unpack the components from inside the grill and oven. Check that the following parts are present:

Grill pan and grid	Top oven shelf heat shield
Baking dish	Pan supports
Main oven shelves (2)	Enamelled burner caps (4)
Top oven/grill shelf (1)	Literature
Aluminium burner bodies (4)	

LEVELLING

Four skid feet are fitted which can be adjusted up or down to level the cooker.

CONVERSION FOR USE ON BUTANE (G30) OR PROPANE (G31)

Each burner requires the injector to be replaced and bypass screws adjusted or replaced as follows:

1. Remove the loose hotplate burner parts.
2. Using a 7mm socket, replace the hotplate injectors as appropriate (see table on previous page).
3. Re-position the loose burner parts.
4. Remove the enamelled baffle at the front of the grill (2 screws).

5. Remove the screw on the right hand side of the burner and gently slide the burner off the injector.
6. Using a 7mm socket, replace the grill injector as appropriate (see table on previous page).
7. Re-assemble the burner and baffle.
8. Inside the top oven, remove the central screw securing the burner retainer. Slide the retainer to the right slightly and lift away.
9. Lift the burner assembly and place on the floor of the oven to the right of the burner opening.
10. Using a 7mm socket, replace the oven injector as appropriate (see table on previous page).
11. Re-assemble the oven burner and retainer.
12. Replace the main oven injector following the same procedure as for the top oven.
13. From behind the cooker, remove the screws securing the rear panel and swing the left hand side outwards (viewed from the rear) to gain access to the main oven flame supervision device.
14. Replace the flame supervision device bypass screw.
15. Re-assemble the rear panel.
16. Carefully pull off the control knobs and timer buttons.
17. Remove the 2 screws securing the underside of the control panel. Slide the control panel to the left slightly to remove.
18. Remove the 6 screws securing the timer mounting panel. Without completely removing it, manoeuvre the timer mounting panel to gain access to the thermostat bypass screws.
19. Using a narrow flat bladed screwdriver rotate the bypass screws fully clockwise. The main oven thermostat bypass screw is located on the body of the thermostat below the spindle, the top oven thermostat bypass screw is located on the body of the thermostat to the right of the spindle and the hotplate tap bypass screws are located down the centre of the spindle.
20. Re-assemble the control panel parts.
21. Secure the self-adhesive LPG conversion label over the gas details on the data badge.

STABILITY CHAIN

A hole in the gas inlet valve bracket can be used to engage a stability chain.

CONNECTING TO GAS SUPPLY

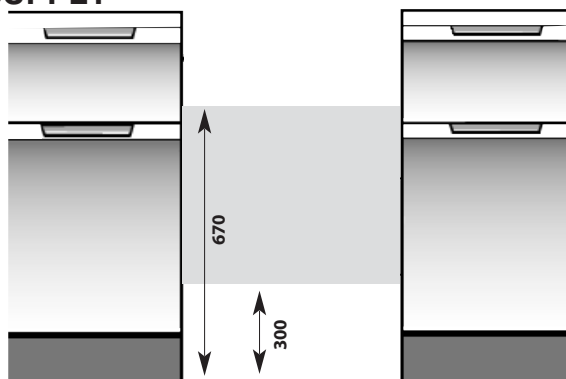

Connection to the cooker should be made with an approved appliance flexible connection to BS 669. A length of 0.9 to 1.25m is recommended. The length of hose chosen should be such that when the cooker is in situ, the hose does not touch the floor.

Those cookers converted to use on LPG should be connected with a hose suitable for LPG and capable of withstanding a pressure of 50 mbar.

An adaptor backplate should be fitted within the shaded area shown, to allow the cooker to be pushed fully to the wall and to ensure that the flexible hose is only likely to come into contact with areas at the rear of the cooker that do not exceed a temperature rise of 70°C.

ELECTRICAL CONNECTION

WARNING - THIS APPLIANCE MUST BE EARTHED. CONNECT TO A 230-240V A.C. SUPPLY ONLY.

Connection to the electricity supply should be made via a properly earthed, readily accessible wall socket which is adjacent to but not directly above, and not more than 1.25m away from the appliance and capable of electrical isolation.

The mains lead should be routed such that it cannot touch hot parts of the cooker i.e. the back panel above a height of 650mm from the floor.

Should this plug not fit the socket outlet in your home it should be cut off and replaced with a suitable plug as outlined below.

NOTE: The removed plug cannot be used for any other appliance and should therefore be properly disposed of and not left where children might find it and plug it into a supply socket - with the obvious consequent danger.

IF THE FITTED PLUG IS REMOVED

The flexible mains lead must be correctly connected as below to a three pin plug of not less than 13 amp capacity. If a B.S. 1363 fused plug is used, it must be fitted with a fuse which is approved to B.S. 1362.

IMPORTANT: The wires in the mains lead fitted to this appliance are coloured in accordance with the following code:

GREEN AND YELLOW - EARTH
BLUE - NEUTRAL
BROWN - LIVE

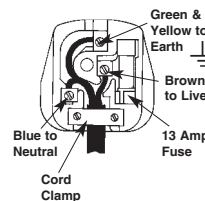

As the colours of the wires in the mains lead of this appliance may not correspond with the coloured markings identifying the terminals in your plug, proceed as follows:

The wire which is coloured green and yellow must be connected to the terminal in the plug which is marked with the letter E or by the earth symbol \equiv or coloured green or green and yellow.

The wire which is coloured blue must be connected to the terminal which is marked with the N or coloured black.

The wire which is coloured brown must be connected to the terminal which is marked with the letter L or coloured red.

When wiring the plug, ensure that all strands of wire are securely retained in each terminal. Do not forget to tighten the mains lead clamp on the plug.

As the appliance must be earthed, **do not use** 2-pin sockets outlets, **if you are in doubt, consult a qualified electrician.**

Should the mains lead ever require replacement, it is essential that this operation be carried out by a qualified electrician and should only be replaced with a flexible cord of the same size i.e. 1.0mm² cross sectional area PVC cable, available from our parts department (see Back Cover).

IF A MOULDED PLUG IS FITTED

In the event of replacing a fuse in the plug supplied an ASTA approved fuse to BS1362 must be fitted.

NOTE: The fuse cover must be refitted when changing the fuse. In the event of losing the fuse cover the plug must not be used until a replacement fuse cover has been obtained and fitted. A new fuse cover can be obtained from your local Electricity Board. The colour of the correct replacement fuse cover is that of the coloured marks or inserts in the base of the plug.

Make sure that the cable does not become trapped when pushing the cooker into position.

WARNING. If the electric supply fails to this appliance you must not use the grill or ovens.

PLEASE PHONE US TO REGISTER YOUR APPLIANCE AND ACTIVATE YOUR PARTS GUARANTEE ON 08448 24 24 24

INSTALLATION INSTRUCTIONS Hotpoint

INSTALLATION AND OPERATIONAL CHECKS

After installation, check for gas soundness. The supply pressure can be checked at the front left hotplate burner injector.

Fit the hotplate burner bodies and caps, pan supports and shelf shield(s). Referring to the instructions for use where necessary,

1. Check that the hotplate burners ignite and cross-light to all ports. Check for a steady flame on the low setting.
2. Check that the grill burner ignites and cross-lights to all ports and that the flames remain when the control is released 3 seconds later, Check for a steady flame on the low setting.
3. Check that with the main oven set to mark 9, the burner ignites and that the flames remain when the control is released 3 seconds later. Leave the oven full on with the door closed for 10 minutes, and check that when the control is turned to mark 1 that the flame reduces.
4. Check that with the top oven set to mark 8, the burner ignites and that the flames remain when the control is released 3 seconds later. Leave the oven full on with the door closed for 10 minutes, and check that when the control is turned to mark 1 that the flame reduces.
5. Check the operation of the timer and oven light.

Instruct the user on operation of the cooker.

On those models adjusted for use with LPG, it is normal for the oven and grill burners to burn with yellow tips.

Features

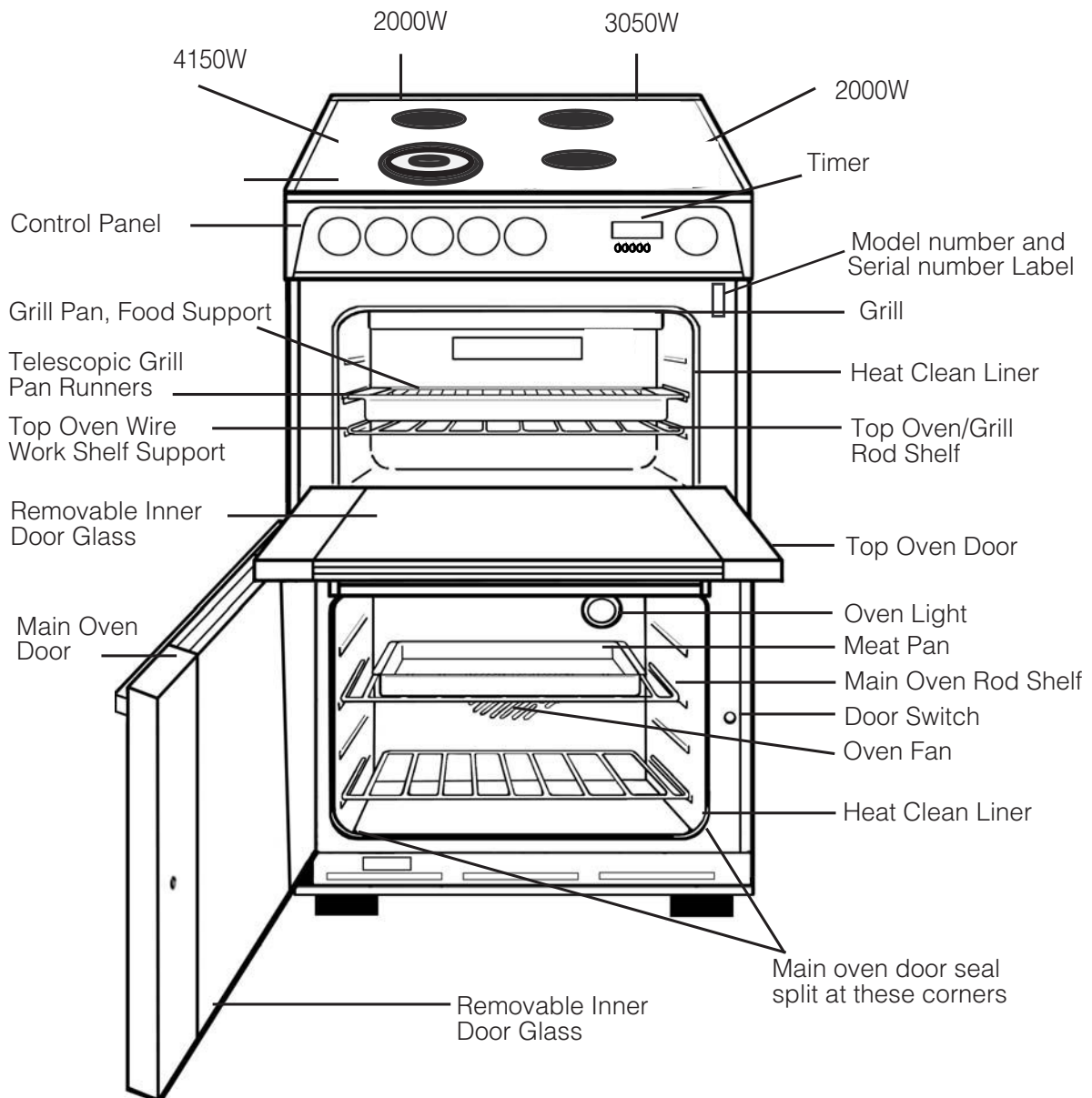

ELECTRONIC INJECTION BUTTON*

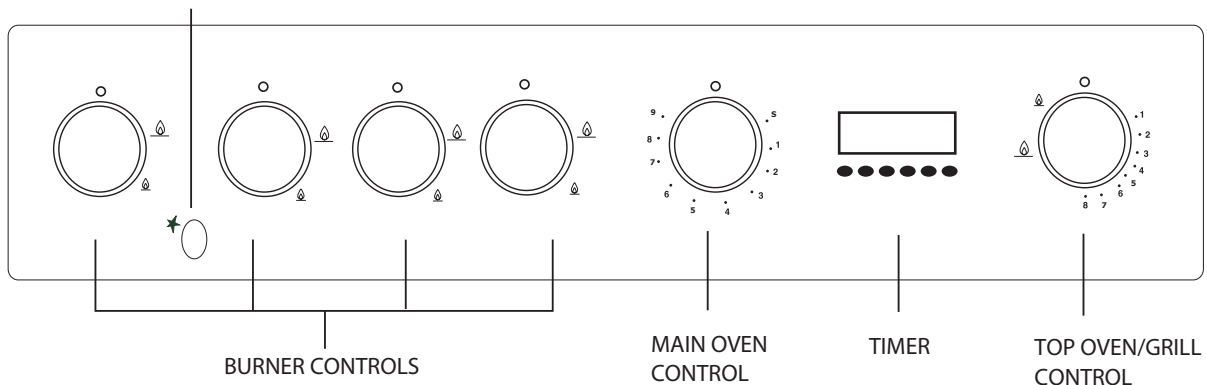

Control Knobs for the gas burners

The position of the gas burner controlled by each one of the knobs is shown by a solid ring ●. To light one of the burners, hold a lighted match or lighter near the burner and, at the same time, press down and turn the corresponding knob counter clockwise to the maximum 🔥 setting. Each burner can be operated at its maximum, minimum or intermediate power. Shown on the knob are the different symbols for off ● (the knob is on this setting when the symbol corresponds with the reference mark on the control panel), for maximum 🔥 and minimum 🔥. To obtain these settings, turn the knob counter clockwise with respect to the off position. To turn off the burner, turn the knob clockwise until it stops (corresponding again with the ● symbol).

Electronic Ignition for the Gas Hob*

This device operates when a slight pressure is applied to the button marked with ★ symbol. To light a specific burner just press the button ★ while pushing the corresponding knob all the way in and turning it counter-clockwise until it lights. For immediate lighting, first press the button and then turn the knob.

! Should the burner flames accidentally go out, turn off the control knob and wait at least 1 minute before trying to relight.

Top Oven / Grill Control

This control switches on the top and bottom heating elements in the top oven. The temperature in the oven can be set anywhere between 100°C and 220°C. The temperature of the top oven can be set anywhere between 80°C and 230°C by turning the knob clockwise from 1 to 8.

To set the grill turn the corresponding knob to 🔥

The grill can be operated at minimum 🔥 and maximum 🔥 setting.

Main Oven Control

This control switches on the top and rear heating elements at various times in the main oven, dependent on which mode has been set. The temperature of the main oven can be set anywhere between 80°C and 230°C by turning the knob clockwise from 1 to 9.

'S' SLOW Setting*

This is used for slow cooking, keeping food warm and warming plates for short periods.

*Only on certain models

PLEASE PHONE US TO REGISTER YOUR APPLIANCE AND ACTIVATE YOUR PARTS GUARANTEE ON 08448 24 24 24

OVEN TIMER OPERATION

The oven timer offers you the following features:

1. Time of Day
2. Automatic Cooking
3. Minute Minder

AUTOMATIC COOKING

The main oven can be controlled automatically.

GUIDANCE ON AUTOMATIC COOKING

1. Select foods which will take the same time to cook.
2. Set the oven timer so that the food has just finished or is just about to finish cooking on your return to the oven. This will ensure the food has not cooled down and does not require reheating before serving.
3. Food should be as cold as possible when it goes into the oven, ideally straight from the refrigerator. Frozen meat and poultry should be thawed thoroughly before it is put in the oven.
4. Warm food should never be placed in the oven if there is to be a delay period. Stews prepared by frying the meat and vegetables should be cooked as soon as possible.
5. Dishes containing left-over cooked poultry or meat, for example Shepherds Pie, should not be cooked automatically if there is to be a delay period.
6. Stews and joints should be cooked by the long slow method, so that the delay period is kept to a minimum.
7. On warm days, to prevent harmful bacterial growth in certain foods (ie poultry, joints, etc) the delayed start should be kept to a minimum.
8. Wine or beer may ferment and cream may curdle during the delay period, so it is best to add these ingredients just before serving.
9. Foods which discolour should be protected by coating in fat or tossing in water to which lemon juice has been added, prior to placing food in the oven.
10. Dishes containing liquid should not be filled too full to prevent boiling over.
11. Food should be well sealed (but not airtight) in a container to prevent the loss of liquid during cooking. Aluminium foil gives a good seal.
12. Ensure food is cooked thoroughly before serving.

CLOCKFACE



The timer incorporates a 24 hour clock.

Ensure the correct time of day is always set, before using your cooker.



SYMBOLS



A 'bell' symbol will light up when you select a Minute Minder Period and will remain lit for the period set.

At the end of the Minute Minder Period, the timer will emit an audible tone and the 'bell' symbol will disappear.

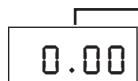

The 'cookpot' symbol will light up either:-

- When the timer is in manual mode, or
- During the actual Cook Period.

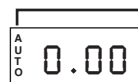

'AUTO' will light up:-

- When the timer is first turned on it will flash. It will go out when a time of day is set or when the timer is set to manual.

The 'AUTO' symbol will flash at the end of an Auto Cooking programme to indicate that the programme has finished.



(When the 'AUTO' symbol is flashing, to return the oven to Manual operation, turn the oven controls off, and press the „Manual” button - The 'AUTO' symbol will go out).

TIMER FUNCTION BUTTONS



Minute Minder Button

Here you can set a time period of up to 23 hours 59 minutes, that will count down. When it reaches zero, the timer will emit an audible tone.

For Example: If you set 20 minutes, the audible tone will occur 20 minutes later.

AUTO COOKING PROGRAMME



Cook Period Button

Cook Period is the actual length of time for which, the timer will switch the oven(s) on as part of an „Auto Cooking” programme. (e.g. If you set 2 hours, the food will be cooked for 2 hours).



End Time Button

The time of day at which you want an „Auto Cooking” programme to end.

For Example: If you set a „Cook Period” for 2 hours, and „End Time” of 11:00. The timer will switch the oven(s) on at 9:00 and turn the oven(s) off at 11:00. You will hear a audible tone at 11:00, to indicate that the Auto Cooking Programme has finished.

Notes:

- When setting an Auto Cooking programme you will need to set the oven control(s) to the required temperature(s) when you set the timer.
- If an Auto Cooking programme has been set the oven(s) will only operate during the pre-programmed time.



Manual Button

Needs to be pressed to cancel an Auto Cooking programme and return the oven(s) to Manual operation.

„+” and „-” Buttons

Used to adjust the various timer function settings.

OVEN TIMER OPERATION

SETTING THE TIME OF DAY

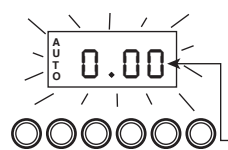

Step 1 Make sure all oven controls are turned Off.

Step 2 Check the electricity supply to the cooker is turned on.

Step 3 When switched on the display will show 0.00 and the Auto symbol, flashing intermittently.

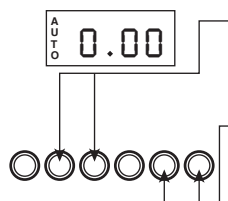

Step 4 Press & hold in both the Cook Period & End Time buttons together.

Step 5 With the Cook Period & End Time buttons still held in, press either the „+” or „-” buttons to set the correct time of day.

Step 6 Release all the buttons simultaneously. THE TIME OF DAY IS NOW SET.

To change the time of day repeat Steps 4, 5 & 6 above.

Note: You cannot adjust the time of day if the timer has been set for an Auto Cooking Programme.

SETTING THE MINUTE MINDER

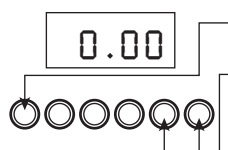

Step 1 Ensure the time of day is set correctly.

Step 2 Press and hold the Minute Minder button.

Step 3 With the Minute Minder button held in, set the required Minute Minder period using the „+” and „-” buttons. A ‚bell’ symbol will light up.

Release all buttons and the timer display will revert back to the time of day. The ‚bell’ symbol will remain lit to signify that a Minute Minder period has been set.

At the end of the set time an audible tone will be heard, and the ‚bell’ symbol will disappear.

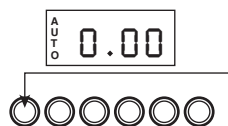

Step 4 To cancel the audible tone press the Minute Minder button.

Note 1 When the Minute Minder has been set, the time remaining can be checked at any time by simply pressing the Minute Minder button.

Note 2 If necessary the Minute Minder can be cancelled before the tone sounds by pressing and holding the Minute Minder button and then at the same time pressing the „-” button until 0.00 appears in the display window.

AUTO COOKING PROGRAMMES

There are two Auto Cooking programmes that can be selected using your timer:-

(a) To set the timer to switch the oven(s) On and Off Automatically

(b) To set timer to switch on immediately and OFF automatically after a set cook period.

a) TO SET THE TIMER TO SWITCH THE OVEN(S) ON AND OFF AUTOMATICALLY

This allows you to cook at a specified time for a chosen period before the oven switches off Automatically.

Step 1 Check that the correct time of day is set, if not follow instructions for setting the time of day.

Step 2 Place food onto the correct shelf position in the oven and close the oven door(s).

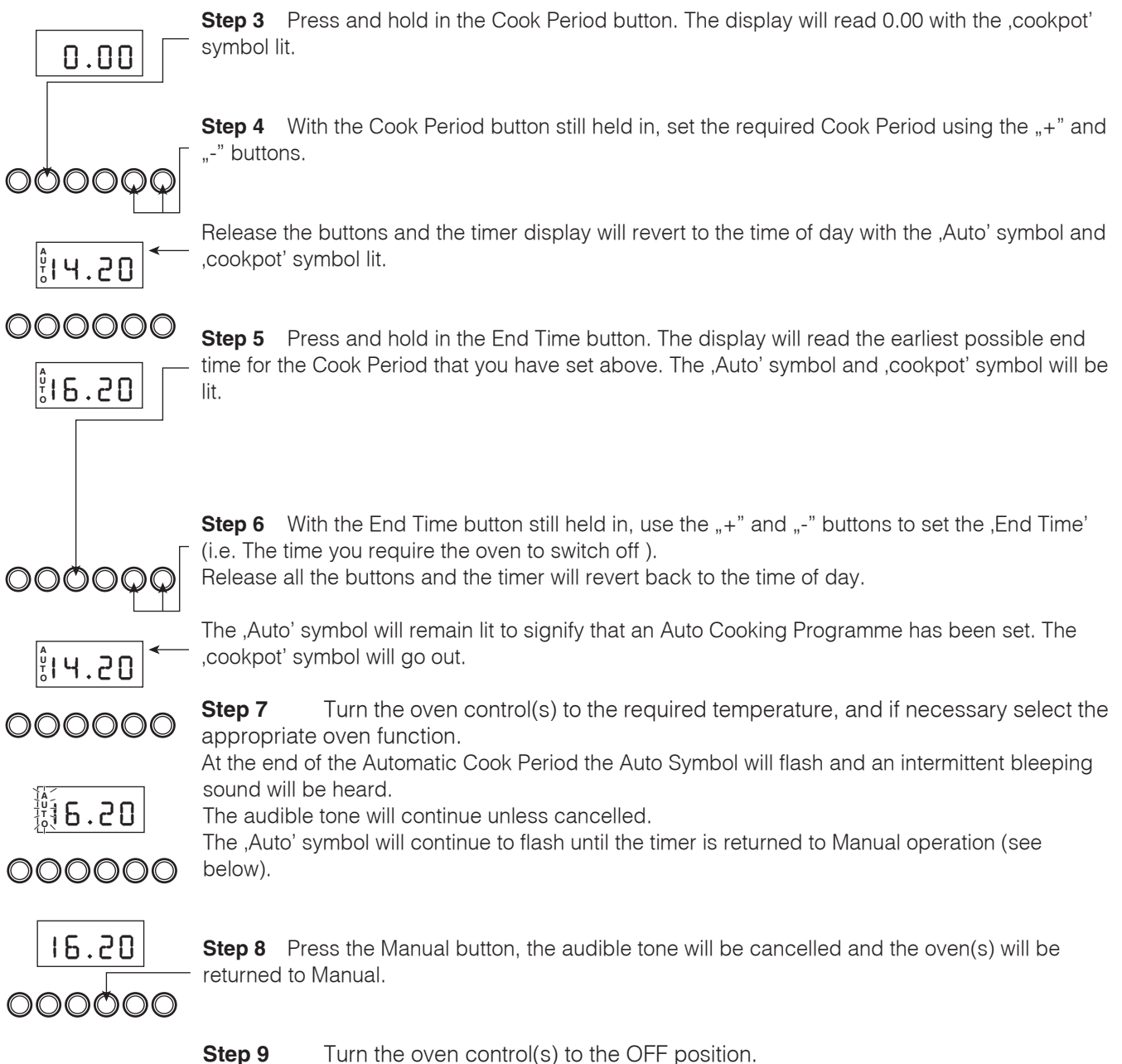

Step 3 Press and hold in the Cook Period button. The display will read 0.00 with the ,cookpot' symbol lit.

Step 4 With the Cook Period button still held in, set the required Cook Period using the „+” and „-” buttons.

Release the buttons and the timer display will revert to the time of day with the ,Auto' symbol and ,cookpot' symbol lit.

Step 5 Press and hold in the End Time button. The display will read the earliest possible end time for the Cook Period that you have set above. The ,Auto' symbol and ,cookpot' symbol will be lit.

Step 6 With the End Time button still held in, use the „+” and „-” buttons to set the ,End Time' (i.e. The time you require the oven to switch off). Release all the buttons and the timer will revert back to the time of day.

The ,Auto' symbol will remain lit to signify that an Auto Cooking Programme has been set. The ,cookpot' symbol will go out.

Step 7 Turn the oven control(s) to the required temperature, and if necessary select the appropriate oven function. At the end of the Automatic Cook Period the Auto Symbol will flash and an intermittent bleeping sound will be heard. The audible tone will continue unless cancelled. The ,Auto' symbol will continue to flash until the timer is returned to Manual operation (see below).

Step 8 Press the Manual button, the audible tone will be cancelled and the oven(s) will be returned to Manual.

Step 9 Turn the oven control(s) to the OFF position.

OVEN TIMER OPERATION

Note 1 When cooking automatically the Cook Period can be checked at any time by simply pressing the Cook Period button.

Note 2 When cooking automatically the End Time can be checked at any time by simply pressing the End Time button.

b) TO SET TIMER TO SWITCH ON IMMEDIATELY AND OFF AUTOMATICALLY AFTER A SET COOK PERIOD

Step 1 Check that the correct time of day is set, if not follow instructions for setting the time of day.

Step 2 Place food onto the correct shelf position in the oven and close the oven door(s).

Step 3 Turn the oven control(s) to the required temperature, and if necessary select the appropriate oven function.

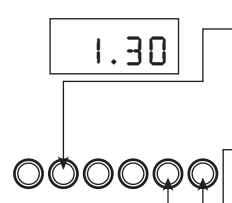

Step 4 Press & hold in the Cook Period button, the display will read 0.00 and the ,cookpot' symbol will light up.
With the Cook Period button still held in set the required Cook Period using the „+” and „-” buttons. Example: 1hr 30 minutes (as shown).

Step 5 Release all buttons.

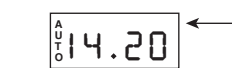

The timer display will revert to the time of day with the ,Auto' symbol lit & ,cookpot' symbol remaining lit.



NOTE: The Cookpot symbol disappears

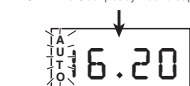

At the end of the Cook Period the ,Auto' symbol will flash and an intermittent audible tone will be heard. The audible tone will continue until cancelled. The ,Auto' symbol will continue to flash until the timer is returned to Manual operation (see below).

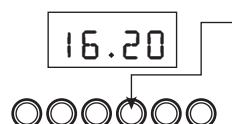

Step 6 Press the Manual button. The audible tone will be cancelled and the oven(s) will be returned to Manual.

Step 7 Turn the oven control(s) to the OFF position.

TO CANCEL AN AUTO COOKING PROGRAMME BEFORE THE COOK PERIOD HAS FINISHED.

Step 1 Turn the oven control to the OFF position.

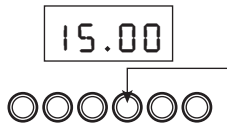

Step 2 Press the Manual button to return the oven to „Manual” operation. The ‚Auto’ symbol will go out.

Note 1 When cooking automatically the Cook Period can be checked at any time by simply pressing the Cook Period button.

OTHER NOTES ON TIMER OPERATION

1. When cooking Automatically the Cook Period can be checked at any time simply by pressing the Cook Period button.
2. When cooking Automatically the End Time can be checked at any time by simply pressing the End Time button.
3. Having set a Cook Period and End Time an electronic device stores the information. The device within the timer will switch the oven(s) on and off at the required times.
4. When setting an Auto Cooking Programme and a mistake is made, to clear:-
 - (a) Press & release the Manual button.
 - (b) Start the sequence again.
5. If at any time the display shows three flashing zero's 0.00 and ‚Auto’, it is likely that the electricity supply to the oven has been interrupted. Reset the timer to the correct time of day. **Food in the oven may, therefore, not have been cooked, before serving check food is thoroughly heated and completely cooked.**
6. To set each function always press and hold the required function button and at the same time press „+” or „-” buttons.

HOTPLATE

The has one very high speed Wok burner, one high speed burner and two simmering burners which will accommodate pans between 100mm (4") and 240mm (9 ½") diameter. All pans should be positioned centrally over the burners.

TO USE THE HOTPLATE

1. Push in and turn the control knob of the chosen burner anti-clockwise to the large flame symbol. Continue to push in the control knob until the sparks light the gas.
2. Turn the control knob anti-clockwise to reduce the heat input. Only turn the control knob between the large flame symbol and the small flame symbol when adjusting the setting.
3. To turn off, turn the control knob fully clockwise to the symbol **O**.

DO NOT use the hotplate unless all pan supports are in position.

DO NOT use mis-shapen pans which may be unstable.

DO NOT use round base woks directly on the pan supports.

Each burner is fitted with a spark ignitor for lighting the gas. To ensure rapid lighting of the burners every time they are used, the ignitors must be kept **clean and dry**. Remove any food spillage or cleaning materials from the ignitor using a small nylon brush such as a tooth brush. Access to the ignitor can be achieved by lifting off the loose burner parts carefully when the burners are cool.

When the hotplate burner bodies and caps are removed for cleaning, be careful not to drop any food particles or cleaning materials into the burner bases, to avoid the possibility of blocking the gas jets.

If aluminium based pans are used, a silvery deposit may appear on the top edge of the pan support fingers. See 'Care and Cleaning' section for cleaning information.

Models with Hob Gas Burner Safety Devices to Prevent Leaks *

These models can be identified by the presence of the device itself.

! Since the hob burners are equipped with a safety device, you must hold the control knob in for about 3-7 seconds after the burner has been lighted to allow the gas to pass until the safety thermocouple has heated.

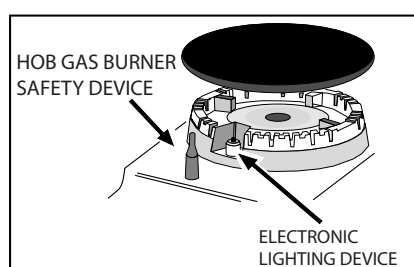

* (only available on certain models)

PLEASE PHONE US TO REGISTER YOUR APPLIANCE AND ACTIVATE YOUR PARTS GUARANTEE ON 08448 24 24 24

SAFETY REQUIREMENTS FOR DEEP FAT FRYING

1. Never fill chip pans more than one third full with oil or fat.
2. Never leave oil or fat unattended during the heating or cooling period.
3. Never heat fat or fry with a lid on the pan.
4. Always dry food thoroughly before frying, and lower it slowly into the hot oil or fat. Frozen foods in particular will cause frothing and spitting if added too quickly.
5. Always keep the outside of the pan clean and free from streaks of oil or fat.

HOW TO DEAL WITH A FAT FIRE

1. **Do not** move the pan.
2. Turn off the hotplate burners.
3. Smother the flames with a fire blanket or damp cloth to extinguish the fire. **Do not** use water or a fire extinguisher as the force of it may spread the burning fat or oil over the edge of the pan.
4. Leave the pan for at least 60 minutes before moving it.

GRILL

CAUTION - ACCESSIBLE PARTS MAY BECOME HOT WHEN THE GRILL IS USED. YOUNG CHILDREN SHOULD BE KEPT AWAY.

The grill is fitted with a safety device that will cut off the gas supply to the burner if the flame is extinguished for any reason. Each time the grill is used, the safety device has to be activated by pushing and holding in the control knob for 3 seconds after the gas has lit.

A gentle flow of air will be blown from underneath the control panel when the grill or top oven is in use. If the fan fails to blow air when the grill is in use, you must stop using and switch off the grill burner immediately and contact our service department.

LARGE EASYGLIDE GRILL PAN

The grill pan is located between the front and rear tags on the easy glide runners. The easy glide runners should be clipped to the top two rails of the shelf supports such that the taller tag is at the rear.

Always use oven gloves to push the grill pan underneath the burner, when withdrawing it, and when removing it from the easyglide runners.

Both the grill pan and the oven shelf can be stored in the grill compartment if the shelf is placed in the lowest position. The grill pan should always be removed from the top oven when baking and NEVER used as a baking/roasting dish in either the top oven or the main oven.

TO USE THE GRILL

1. Open the top oven/grill door and remove the grill pan.
2. Remove the heat shield from the rear of the shelf for maximum grilling area and place shelf in appropriate position.
3. Push in and turn the control knob clockwise to the large flame symbol. Continue to push in the control knob for a further 3 seconds after the gas has lit, to allow time for the safety device to operate. If the burner extinguishes when the control knob is released, repeat the procedure ensuring the control knob is fully depressed and allowing more time for the safety device to operate.
4. Ensure that the appliance is connected to the correct electrical supply and that the supply is switched on.
5. Slide the grill pan along the shelf towards the rear of the grill compartment until it stops.
6. Turn the control knob anti-clockwise to reduce the heat input. Only turn the control knob between the large flame symbol and the small flame symbol when adjusting the setting.
7. To turn off, turn the control knob anti-clockwise to the symbol **○**.

The grill cannot be used at the same time as the top oven. If for any reason the grill burner has not lit after 15 seconds, turn the control knob to the off position, leave the grill door open and wait for at least a minute before attempting to light the burner again.

An odour may be noticed when first using the grill - this should cease after a short period of use.

DO NOT use the grill with the door closed.

DO NOT cover the grill pan or grid with aluminium foil as this can hold fat, intensify the heat and create a fire hazard.

RELIGHTING THE BURNER

In the event of the burner flames being accidentally extinguished, turn off the burner control and do not attempt to re-ignite the burner for at least one minute.

Grilling can be started from cold but for best results preheat for approximately two minutes. Most cooking is done with the heat on full, but it may be desirable to reduce it for thicker pieces of meat or for keeping food warm.

For au gratin dishes eg. Macaroni Cheese and meringue toppings eg. Baked Alaska, place the dish on the floor of the grill compartment. The base of the grill pan can be used for warming fruit garnishes on the reduced setting.

NOTE: Strong detergents used in dishwashers may damage the grill pan grid finish; clean in soapy water as described in CARE AND CLEANING section.

WARNING – DO NOT USE THE GRILL WITHOUT AN ELECTRICAL SUPPLY TO THE COOKER

PLEASE PHONE US TO REGISTER YOUR APPLIANCE AND ACTIVATE YOUR PARTS GUARANTEE ON 08448 24 24 24

WARNING – DO NOT USE THE MAIN OVEN WITHOUT AN ELECTRICAL SUPPLY TO THE COOKER

The main oven is fitted with a safety device that re-lights the burner if the flame has been extinguished for any reason and another safety device that reduces the gas flow to a safe level if, for any reason, the burner fails to light. The oven has different heat zones - the thermostat settings refer to the temperature on the middle shelf position; above this shelf it is hotter and below it is cooler. Two shelves provide five possible cooking levels enabling full use of the different temperatures inside the oven.

Each shelf has a safety stop to prevent it from being pulled out too far when attending to food. Shelves are removed from the oven by pulling them out to the stop and then lifting them at the front to withdraw.

The maximum size of baking tray that should be used is 325mm x 350mm (13" x 14").

TO USE THE MAIN OVEN

1. Check that the timer is set to manual.
2. Place the oven shelves in the appropriate positions (refer to cooking charts).
3. Push in and turn the oven control knob fully anti-clockwise. Sparking will continue until the burner is lit.
4. Ensure that the appliance is connected to the correct electrical supply and that the supply is switched on.
5. Turn the control knob clockwise to the required setting (refer to cooking chart). There is a delay of about one minute whilst the safety device operates before the burner comes on full.
6. To turn off, turn the control knob fully clockwise to the symbol **⏻**.

Never place dishes over the burner.

An odour may be noticed when first using the oven - this should cease after a short period of use.

COLD START COOKING

Anything requiring long slow cooking such as casseroles and rich fruit cakes can be put into a cold oven. Satisfactory results can also be obtained with creamed mixture, rich pastries or yeast mixtures, but for perfection we recommend preheating the oven for about 15 minutes at the gas mark you require for cooking.

ROASTING OF LARGE POULTRY

The maximum weight of poultry that can be accommodated is 11.5kg (25 lbs) of suitable shape. It is important to check that the bird DOES NOT overhang the burner at the back of the oven.

STORAGE AND RE-HEATING OF FOOD

It is vitally important to strictly adhere to the basic principles of food handling and hygiene to prevent the possibility of bacterial growth.

1. If food is to be frozen or not served immediately, cool it in a clean container as quickly as possible.
2. Completely thaw frozen food in the refrigerator before re-heating.
3. Re-heat food thoroughly and quickly either on the hotplate or in a hot oven, Mk. 6, and then serve immediately.
4. Only re-heat food once.

'COOK CHILL' DISHES

These should always be placed in a pre-heated oven ideally on the first or second shelf position. Follow the packet instructions for cooking time.

ALUMINIUM FOIL

If using Aluminium Foil:

1. Remember that it is important to increase the cooking time by one third.
2. Never allow the foil to touch the sides of the oven.
3. Never cover the oven interior with foil.
4. Never cover the oven shelves with foil.

Lower Oven Setting	Temperature °C	Temperature °F
Slow cook	110	230
1	145	293
2	160	320
3	175	347
4	190	374
5	205	401
6	222	432
7	240	464
8	250	482
9	260	500

MAIN OVEN COOKING CHART

The following times and setting are for guidance only. You may wish to alter the setting to give a result more to your satisfaction. When a different setting to that shown below is given in a recipe, the recipe instructions should be followed. Allow 15 minutes preheat for best results.

Always turn the thermostat knob to Mark 9 first, before turning back to the required Gas Mark.

Shelf position 1 is the highest.

Food	Gas Mark	Shelf Positions	Approx. Cooking Time and Comments
STARTERS			
Patés and Terrines	3 or 4	4	1 ½ - 2 hrs
FISH			
Oily Fish (whole)	4 or 5	3	25 mins - 1 hr, depending on recipe and size of fish.
White Fish (fillets & steaks)	4 or 5	3	25 - 30 mins.
MEAT AND POULTRY			
Veal	5	4	25 mins per lb (450g) + 25 mins.
Beef	4 or 5	4	25 - 30 mins per lb (450g) + 25 mins.
Ham	5	4	40 mins per lb (450g) covered in foil + 40 mins per lb (450g) uncovered.
Lamb	5	4	30 - 35 mins per lb (450g) + 30 mins.
Pork	5	4	40 mins per lb (450g) + 40 mins.
Chicken	5	4	25 mins per lb (450g) + 25 mins.
Duckling & gosling	5	4	25 mins per lb (450g) + 25 mins.
Turkey	4 or 5	4 or 5	15 - 20 mins per lb (450g) + 20 mins.
Game birds	6	4	50 mins Removed bacon for last 15 mins. Add extra 15 mins if roasting brace
Casseroles	3	3 or 4	1 ½ - 6 hrs. (depending on type of meat)
PUDDINGS			
Milk Puddings	3	3 or 4	2 ¼ - 2 ½ hrs stand dish on a baking tray and started with warm milk
Baked Custard	3	3 or 4	45 mins in bain-marie
Baked sponges	4	3	40 - 45 mins
Baked Apples	3	4	30 - 45 mins depending on the size and type of apples
Meringue puddings	1	4 or 5	15 mins or until 'tinged' with brown
Apple Pie 1x9" (230 mm)	6	3	45 - 55 mins stand dish on a baking tray
Fruit crumbles	5 or 6	3	35 - 45 mins

MAIN OVEN COOKING CHART Hotpoint

Food	Gas Mark	Shelf Positions	Approx. Cooking Time and Comments
CAKES, PASTRIES AND BISCUITS			
Small cakes - 2 trays	5	1 & 3	17 - 25 mins
- 1 tray	5	2 or 3 only	"
Victoria sandwich 2x8" (205mm)	4	1 & 3	25 - 35 mins.
Fatless sponge 2x7" (180mm) - 3 egg mix	5	2	20 - 25 mins. 2 tins side by side
Christmas cake	2	3 or 4	4 - 6½ hrs depending on recipe
Madeira cake 7"	4	3	1¼ - 1½ hrs.
Rich Fruit cake 9" (230mm)	2	3	3 - 3½ hrs.
Shortcrust pastry	6	2 or 3	15 mins - 1 hr depending on recipe
Rich Shortcrust pastry - 1 tray	5	2	20 - 40 mins. depending on recipe
Flaky & puff pastry - 2 trays	7	1 & 3	10 - 30 mins. depending on recipe
Flaky & puff pastry - 2 trays		2 or 3	" " " "
Choux pastry - éclairs 1 tray	6	2	35 - 40 mins
Scones - 2 trays	7	1 & 3	10 - 15 mins
Scones - 1 trays		2 or 3	"
Shortbread - 7" (180mm) round	2	4	55 - 1hr depending on thickness
Biscuits - 2 trays	4	1 and 3	15 - 20 mins depending on recipe
Biscuits - 1 trays		2 or 3	" " " "
YEAST MIXTURES			
Bread	7 or 8	3 or 4	45 - 50 mins
Rolls	7 or 8	3 or 4	15 - 20 mins
Chelsea buns	5	2 or 3	30 - 40 mins
MISCELLANEOUS			
Yorkshire Pudding - large	7	1 or 2	45 - 50 mins
Yorkshire Pudding - individual	7	1 or 2	25 - 30 mins
Soufflés	4	3	30 mins
Meringues	Slow Cook	4 & baseplate	2 - 5 hrs starting on shelf 4 until 'set' and then on the baseplate until dried out - turn when necessary.
Baked Potatoes	4 or 5	3	1½ - 4 hrs until soft, depending on size

When baking with two trays or tins on two levels, the top tray is removed first and the lower tray moved up to the top position for a few minutes longer.

Soft Margarine - Use the oven settings recommended by the margarine manufacturer and **not** those indicated on the cooking chart.

PLEASE PHONE US TO REGISTER YOUR APPLIANCE AND ACTIVATE YOUR PARTS GUARANTEE ON 08448 24 24 24

THE 'SLOW COOK' SETTING

The 'Slow Cook' setting on the main oven thermostat is used for slow cooking, keeping food warm and warming plates for short periods.

USING THE 'SLOW COOK' SETTING FOR SLOW COOKING

1. All dishes cooked by the 'Slow Cook' setting should be cooked for a minimum 6 hours. They will 'hold' at this setting for a further hour but marked deterioration in appearance will be noticed in some cases.
2. Joints of meat and poultry should be cooked at Mk. 6 for 30 minutes before turning to the 'Slow Cook' setting and never be cooked lower than the middle shelf position.
3. Joints of meat over 6 lbs (2.7kg) and poultry over 4 lbs 8oz (2 kg) should not be cooked using the 'Slow Cook' setting.
4. Always stand covered joints on a rack over the meat tin to allow good air circulation.
5. A meat thermometer should be used when cooking pork joints and poultry. The internal temperature of the food should reach at least 88°C.
6. This method is unsuitable for stuffed meat and stuffed poultry.
7. Always bring soups, casseroles and liquids to the boil before putting in the oven.
8. Cover casseroles with foil and then the lid to prevent loss of moisture.
9. Always thaw frozen food completely before cooking.
10. Root vegetables will cook better if cut into small pieces.
11. Adjust seasonings and thickenings at the end of the cooking time.
12. Use the zones of heat in the oven, e.g. meringues and milk puddings can be cooked lower in the oven whilst other dishes requiring greater heat can be cooked above them.
13. Egg and fish dishes need only 1-5 hours cooking and should be included in day cooking sessions, when they can be observed from time to time.
14. Dried red kidney beans must be boiled for a minimum of ten minutes after soaking, before inclusion in any dish.

The top oven can be used to cook small quantities of food or used in conjunction with the main oven to provide additional cooking space.

The top oven is fitted with a safety device that will cut off the gas supply to the burner if the flame is extinguished for any reason. Each time the top oven is used, the safety device has to be activated by pushing and holding in the control knob for 3 seconds after the gas has lit.

A gentle flow of air will be blown from underneath the control panel when the grill or top oven is in use. If the fan fails to blow air when the top oven is in use, you must stop using and switch off the oven burner immediately and contact our service department.

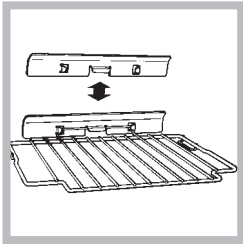

The shelf in the top oven has a heat shield fitted at the rear. The shield can be removed for cleaning and grilling, but should be replaced when using the oven for best cooking results. It has a safety stop to prevent it from being pulled out too far when attending to food. The shelf is removed from the oven by pulling it out to the stop and then lifting at the front to withdraw.

The maximum size of baking tray that should be used is 300mm x 350mm (12" x 14").

TO USE THE TOP OVEN

1. Remove the grill pan and check that the heat shield is fitted to the shelf.
2. Place the top oven shelf in the appropriate position (refer to cooking chart).
- 3- Ensure that the appliance is connected to the correct electrical supply and switched on
4. Push in and turn the control knob fully anti-clockwise. Continue to push in the control knob for a further 3 seconds after the gas has lit to allow time for the safety device to operate. If the burner extinguishes when the control knob is released, repeat the procedure ensuring the control knob is fully depressed and allowing more time for the safety device to operate.
5. Turn the control knob clockwise to the required setting. (refer to cooking chart).
6. To turn off, turn the control knob clockwise to the symbol **O**.

Always push the door firmly closed to ensure that there is no loss of heat through the door seal.

If for any reason the oven burner has not lit after 15 seconds, turn the control knob to the OFF position. Leave the top oven door open and wait at least one minute before attempting to light the burner again.

GUIDANCE ON USING THE TOP OVEN

1. Best results are obtained by pre-heating the oven for about 15 minutes.
2. Food which is higher than or will rise above 125mm (5") cannot be cooked in the top oven.

Never place dishes over the burner.

An odour may be noticed when first using the oven - this should cease after a short period of use.

RELIGHTING THE BURNER

In the event of the burner flames being accidentally extinguished, turn off the burner control and DO NOT attempt to re-ignite the burner for at least one minute.

Upper Oven Setting	Temperature °C	Temperature °F
1	120	248
2	140	284
3	160	320
4	175	347
5	190	374
6	205	401
7	215	419
8	225	437

The equivalent degrees Celsius (sometimes called Centigrade) and degrees Fahrenheit are shown below as a guide.

TOP OVEN COOKING CHART

The following times and setting are for guidance only. You may wish to alter the setting to give a result more to your satisfaction. When a different setting to that shown below is given in a recipe, the recipe instructions should be followed.

Allow 15 minutes preheat for best results. Always turn the thermostat knob to Mark 8 first, before turning back to the required Gas Mark.

Food	Gas Mark	Shelf Positions	Approx. Cooking Time and Comments
STARTERS			
Oily and white fish	5	2	20 - 30 mins.
MEAT AND POULTRY			
Beef (medium)	4 or 5	3	25 - 30 mins per lb + 25 - 30 mins.
Ham (covered in foil)	5	3	40 mins per lb + 40 mins
Lamb	5	3	30 - 35 mins per lb + 30 mins.
Pork	5	3	40 mins per lb + 40 mins.
Chicken	5	3	25 mins per lb + 25 mins.
Duckling & Goose	5	3	25 mins per lb + 25 mins.
Turkey	4	3	15 - 20 mins per lb + 15 - 20 mins.
Casseroles	3	3	2 - 4 hrs. depending on meat used
VEGETABLES			
Baked jacket potatoes	5	2	1 ½ hrs.
PUDDINGS			
Milk Puddings (500ml/1pt)	3	2	1 ½ hrs.
Baked Custard (500ml/1pt)	3	2	45 mins - 1 hr. in bain-marie of cold water
Baked Sponge Puddings	4	2	30 - 45 mins
Baked Apples	3	2	45 mins - 1 hr. depending on size
Meringue Topped Puddings	1	2	25 mins until tinged with brown
Apple Tart (1x205 mm/8")	6	2	60 mins
Fruit Crumble	5	2	45 - 50 mins

If using aluminium foil:

1. Remember it is important to increase the cooking time by one third.
2. Do not allow the foil to touch the sides of the oven.
3. Do not cover the oven interior with foil.
4. Do not cover the oven shelves with foil.

TOP OVEN COOKING CHART Hotpoint

Food	Gas Mark	Shelf Positions	Approx. Cooking Time and Comments
CAKES, PASTRIES AND BISCUITS			
Small Cakes (16 per tray)	5	2	20 - 25 mins
Victoria sandwich (2x180mm / 7")	4	2	25 - 30 mins.
Swiss Roll (3 egg quantity)	6	2	10 - 12 mins.
Christmas cake (1 x 205mm / 8")	2	2 or 3	4 - 5 hrs depending on recipe
Madeira cake (1 x 180mm / 7")	4	2	1 hr.
Rich Fruit cake (1 x 180mm / 7")	2	2 or 3	2¼ - 2½ hrs.
Gingerbread	3	2	1½ - 1¾ hrs.
Scones - 16 per tray	7	2	12 - 15 mins.
Shortbread (1 x 180mm / 7")	2	2	45 mins. - 1hr depending on thickness
Biscuits	4 - 6	2	15 - 25 mins.
Shortcrust Pastry	6	2	15 mins. - 1 hr. depending on recipe
Rich Short Crust	5	2	20 - 30 mins.
Flaky/Puff Pastry	7	2	10 - 30 mins. depending on recipe
Choux Pastry	6	2	25 - 35 mins.
YEAST MIXTURES			
Bread - rolls, plait	7	2 or 3	25 - 35 mins
Tea breads etc.	5	2	25 - 30 mins
MISCELLANEOUS			
Yorkshire Pudding - small	7	2	20 - 25 mins
Yorkshire Pudding - large	7	2	30 - 40 mins
Meringues	1	2	2½ - 4 hrs turn when necessary.

Soft Margarine - Use the oven settings recommended by the margarine manufacturer and **not** those indicated on the cooking chart.

CARE AND CLEANING

! Never use steam cleaners or pressure cleaners on the appliance.

! Clean the glass part of the oven door using a sponge and a non-abrasive cleaning product, then dry thoroughly with a soft cloth. Do not use rough abrasive material or sharp metal scrapers as these could scratch the surface and cause the glass to crack.

! The accessories can be washed like everyday crockery (even in your dishwasher).

! Switch off the electricity supply and allow to cool before cleaning the cooker.

! Clean the cooker regularly and wipe up spills soon after they occur to prevent them from becoming burnt on. Never use biological washing powder, caustic cleaners, harsh abrasives, scouring pads, steam cleaners, aerosol cleaners or oven chemical cleaners of any kind.

! If it is necessary to remove the cooker for cleaning, ensure that it is cool and beware that it is heavy (approximately 70 kg 155 lbs).

! To move the cooker forward, open the top oven/grill door and with both hands positioned under the roof of the compartment, lift and pull forward. Replace by pushing the cooker backwards.

! Check that the cooker is level. Take care not to damage any floor coverings.

OVEN HEAT CLEAN LININGS

The oven side linings are coated with a special enamel which has a continuous cleaning action.

The higher the oven temperature the more effective the action. In most cases this cleaning operation will proceed during normal cooking. However, if roasting is done frequently, or high temperatures are not used regularly, it may be necessary to occasionally operate the oven empty at Mark 8 for about an hour.

It should not normally be necessary to clean the linings with water, but if desired, wipe them over with a soapy cloth, followed by a wipe with a damp clean cloth.

OVEN DOORS

The door inner glass panels can be removed for ease of cleaning by simply sliding the panels out of the frame.

REPLACEMENT OF OVEN LIGHT BULB

CAUTION: DISCONNECT THE APPLIANCE FROM THE ELECTRICITY SUPPLY BEFORE REPLACING THE LAMP TO AVOID THE POSSIBILITY OF AN ELECTRIC SHOCK.

Light bulbs are not covered by the manufacturer's guarantee.

A new 25W, 300°C rated SES bulb can be obtained from your cooker supplier or any major electrical retailer.

1. Remove the shelves from the oven.
2. Unscrew the lens using a thick cloth to protect your fingers in the unlikely event of a lens fracture.
3. Unscrew bulb.
4. Fit new bulb and refit lens.

BURNER MAINTANANCE INSTRUCTIONS

Before cleaning the burners ensure the appliance is switch off and isolated from the electrical supply and the appliance is cold.

MAIN OVEN

When the main oven is used regularly, its burner is susceptible to being covered with grease and dirt. This might result in problems with the burner's ignition as well as the uneven or disappearing flame. To solve the problem clean the burner with a small amount of water- diluted cleaner (e.g. CIF) using a small brush (e.g. a toothbrush). After cleaning wipe the burner with a cloth to remove the detergent waste and let it dry for at least 2 hours.

WARNING!

1. Brush the burner in the directions indicated below.
2. DO NOT re-ignite the burner with the detergent residue.

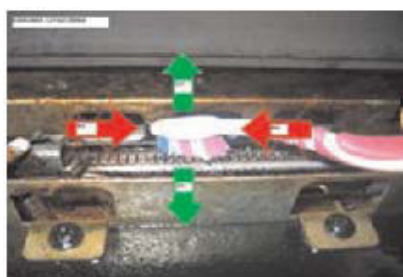

TOP OVEN/GRILL

When the Top oven/grill is used regularly, its burner is susceptible to being covered with grease and dirt. This might result in problems with the burner's ignition as well as the uneven or disappearing flame. To solve the problem clean the burner with a small amount of water- diluted cleaner (e.g. CIF) using a small brush (e.g. a toothbrush). After cleaning wipe the burner with a cloth to remove the detergent waste and let it dry for at least 2 hours.

WARNING!

1. Brush the burner in the directions indicated below.
2. DO NOT re-ignite the burner with the detergent residue.



CARE AND CLEANING

COOKER FINISH	CLEANING METHOD
Vitreous Enamel Door inner panels, pan supports, burner caps, roasting dish, grill pan, main oven base, inside of grill compartment.	Cloth wrung out in warm soapy water. Stubborn stains can be removed with a cream paste, liquid cleaner or by rubbing with fine steel wool soap pads. Check that the cleaning agent is approved by the Vitreous Enamel Association.
Paint Side panels.	Wash with a cloth wrung out in warm soapy water only. DO NOT USE ABRASIVES.
Aluminium Hotplate burner bodies, lid rear trim.	Similar to paint cleaning above. Use a nylon brush to remove any cleaning materials, water or dirt from the hotplate burner bodies.
Glass	As for enamel cleaning. Polish with a clean dry cloth or kitchen roll.
Chromium Plating Oven shelves, grill pan grid, grill pan handle, grill pan handle support.	Wipe with a cloth wrung out in warm soapy water. A fine steel wool soap pad e.g. Brillo, Ajax, or a chrome or stainless steel cleaner may be used.
Plastic Control knobs.	Wipe with a cloth wrung out in warm soapy water.
Stainless Steel Hotplate, control panel.	Wipe with a cloth wrung out in warm soapy water. Polish with a clean dry cloth or kitchen towel. For stubborn stains, use a proprietary stainless steel cleaner and follow the instructions on the container.

Assembling the sliding rack kit*

To assemble the sliding racks:

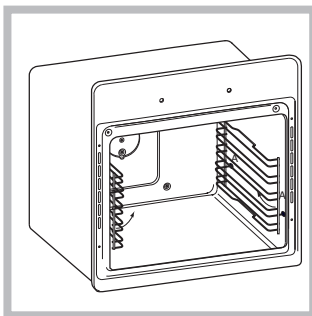

1. Remove the two frames, lifting them away from the holes A (see figure).

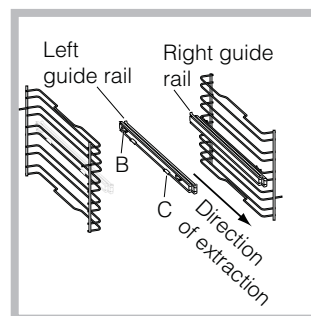

2. Choose which shelf to use with the sliding rack. Paying attention to the direction in which the sliding rack is to be extracted, position joint B and then joint C on the frame.

3. Secure the two frames with the guide rails using the holes provided on the oven walls.

! Do not place the sliding racks in position 5.

*Only on certain models

SOMETHING WRONG WITH YOUR COOKER Hotpoint

Before contacting your nearest Service Centre/Installer, check the problem guide below; there may be nothing wrong with your cooker.

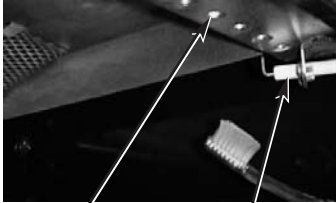
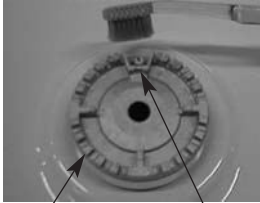
PROBLEM	CHECK
<p>Burner will not light:</p> <div style="text-align: center;"> <p><i>Grill burner:</i></p>  <p>Burner ports Ignitor</p> </div> <div style="text-align: center; margin-top: 20px;"> <p><i>Hotplate burner:</i></p>  <p>Burner ports Ignitor</p> </div>	<p>If all burners fail to ignite: Check that sparks appear at the burners; a clicking noise should be heard. If not;</p> <p>Check that the electricity supply is turned on. If the electricity supply has failed, you can only use the hotplate burners, which can be lit by a match. - DO NOT USE THE GRILL OR OVEN(S) WITHOUT AN ELECTRICAL SUPPLY BEING CONNECTED TO THE COOKER</p> <p>If only one burner fails to ignite: Check that the burner is dry and that spillage of food or cleaning fluid remains are not affecting the ignitor or burner ports. Clean away any debris with a dry nylon brush such as an old toothbrush. If a wire wool pad has been used for cleaning around the burner ensure the ignitor is free from any stray strands. Any water on the burner should be dried with a cloth or kitchen towel.</p> <p>Make sure that all the burners parts are correctly seated.</p>

Respecting and conserving the environment

- Whenever possible, avoid pre-heating the oven and always try to fill it. Open the oven door as little as possible because heat is lost every time it is opened. To save a substantial amount of energy, simply switch off the oven 5 to 10 minutes before the end of your planned cooking time and use the heat the oven continues to generate.
- Keep gaskets clean and tidy to prevent any door energy losses
- If you have a timed tariff electricity contract, the "delay cooking" option will make it easier to save money by moving operation to cheaper time periods.
- The base of your pot or pan should cover the hot plate. If it is smaller, precious energy will be wasted and pots that boil over leave encrusted remains that can be difficult to remove.
- Cook your food in closed pots or pans with well-fitting lids and use as little water as possible. Cooking with the lid off will greatly increase energy consumption
- Use purely flat pots and pans
- If you are cooking something that takes a long time, it's worth using a pressure cooker, which is twice as fast and saves a third of the energy.

PLEASE PHONE US TO REGISTER YOUR APPLIANCE AND ACTIVATE YOUR PARTS GUARANTEE ON 08448 24 24 24

SOMETHING WRONG WITH YOUR COOKER

PROBLEM	CHECK
Slight odour or small amount of smoke when grill / oven used first time.	This is normal and should cease after a short period.
Oven cooks too fast or too slow.	Check that the oven temperature and shelf positions are as recommended in the Oven Cooking Charts. However, it may be necessary to increase or decrease the recommended setting slightly to suit your taste.
Cannot set an "Auto Cook" programme or cannot get the timer to turn the oven on or off at the required times.	Read the Timer instructions in this book carefully remembering that the Cook period is the length of time that the timer will switch the oven(s) on as part of an Auto Cooking Programme.
Timer Display shows "0:00" with "Auto" Flashing.	The electricity supply to the cooker may have been interrupted, but has now come back on again. set the correct time of day by following the instructions given in the timer section of this book.
Main oven does not work, but the grill, top oven and hotplate burners work.	The timer may be set for an Auto Cooking Programme. Check the timer to see if "AUTO" is illuminated. If it is, follow the instructions given in the timer section of this book to cancel the Auto Cooking Programme.
Oven lamp does not work.	The oven lamp is not covered by the guarantee. The part is easily changed (see the section on oven lamp replacement). A new lamp may be obtained from our Spare Parts department, see Key Contacts (back page).

Disposal of your product

To minimise the risk of injury to children please dispose of your product carefully and safely. Remove all doors and lids. Remove the mains cable (where fitted) by cutting off flush with the appliance and always ensure that no plug is left in a condition where it could be connected to the electricity supply.

To help the environment, Local Authority instructions should be followed for the disposal of your product.



Disposal of old electrical appliances

The European Directive 2002/96/EC on Waste Electrical and Electronic Equipment (WEEE), requires that old household electrical appliances must not be disposed of in the normal unsorted municipal waste stream. Old appliances must be collected separately in order to optimise the recovery and recycling of the materials they contain and reduce the impact on human health and the environment.

The crossed out „wheeled bin” symbol on the product reminds you of your obligation, that when you dispose of the appliance it must be separately collected.

Consumers should contact their local authority or retailer for information concerning the correct disposal of their old appliance.



Guarantee

12 months Parts and Labour Guarantee

Your appliance has the benefit of our manufacturer's guarantee, which covers the cost of breakdown repairs for twelve months from the date of purchase.

This gives you the reassurance that if, within that time, your appliance is proven to be defective because of either workmanship or materials, we will, at our discretion, either repair or replace the appliance at no cost to you.

The guarantee is subject to the following conditions:

- The appliance has been installed and operated correctly and in accordance with our operating and maintenance instructions.
- The appliance is only used on the electricity or gas supply printed on the rating plate.
- The appliance has been used for normal domestic purposes only.
- The appliance has not been altered, serviced, maintained, dismantled or otherwise interfered with by any person not authorised by us.
- Any repair work must be undertaken by us or our appointed agent.
- Any parts removed during repair work or any appliance that is replaced become our property.
- The appliance is used in the United Kingdom or Republic of Ireland.

The guarantee does not cover:

- Damage resulting from transportation, improper use, neglect or interference or as a result of improper installation.
- Replacement of any consumable item or accessory. These include but are not limited to: plugs, cables, batteries, light bulbs, fluorescent tubes and starters, covers and filters.
- Replacement of any removable parts made of glass or plastic.

THE GUARANTEE WILL NOT APPLY IF THE APPLIANCE HAS BEEN USED IN COMMERCIAL OR NON-DOMESTIC PREMISES.

5 Year Parts Guarantee

Hotpoint also offers you a FREE 5 year parts guarantee. This additional guarantee is conditional on you registering your appliance with us and the parts being fitted by one of our authorised engineers. There will be a charge for our engineer's time. To activate the extra parts warranty on your appliance, simply call our registration line on **08448 24 24 24 (ROI 01 230 0800)**

Extended Guarantees

We offer a selection of protection plans that enable you to fully cover yourself against the expense of repair bills for the life of your policy. To find the ideal plan for you please call our advice line on **08448 226 226 (ROI 01 230 0233)**

Free Helpdesk Service

We have a dedicated team who can provide free advice and assistance with your appliance if you experience any technical difficulties within the first 90 days of ownership. Simply call our Hotpoint Service Hotline on **08448 224 224 (ROI 0818 313 413)** for telephone assistance, or, where necessary, to arrange for an engineer to call.

PLEASE PHONE US TO REGISTER YOUR APPLIANCE AND ACTIVATE YOUR PARTS GUARANTEE ON 08448 24 24 24



After Sales Service

No one is better placed to care for your Hotpoint appliance during the course of its working life than us - the manufacturer.

Essential Contact Information

Hotpoint Service

We are the largest service team in the country offering you access to 400 skilled telephone advisors and 1100 fully qualified engineers on call to ensure you receive fast, reliable, local service.

UK: 08448 224 224

Republic of Ireland: 0818 313 413

www.hotpoint.co.uk

Please note: Our advisors will require the following information:

Model number

Serial number

Parts & Accessories

We supply a full range of genuine replacement parts as well as accessory products that protect and hygienically clean your appliance to keep it looking good and functioning efficiently throughout its life.

UK: 08448 225 225

Republic of Ireland: 0818 313 413

www.hotpointservice.co.uk

Appliance Registration

We want to give you additional benefits of Hotpoint ownership. To activate your FREE 5 year parts guarantee you must register your appliance with us.

UK 08448 24 24 24

Republic of Ireland: 01 230 0800

www.hotpointservice.co.uk

As part of Hotpoint's continued commitment to helping the environment, Hotpoint reserves the right to use quality, recycled components to keep down customer costs and minimise material wastage.

Indesit Company UK Limited, Morley Way, Peterborough, PE2 9JB

Indesit Company, Unit 49 Airways Industrial Estate, Dublin 17

PLEASE PHONE US TO REGISTER YOUR APPLIANCE AND ACTIVATE YOUR PARTS GUARANTEE ON 08448 24 24 24

Indesit Company S.P.A.

Viale Aristide Merloni,47
60044 Fabriano (AN)
www.hotpoint.co.uk

04/2014- 195122679.00
XEROX FABRIANO

PLEASE PHONE US TO REGISTER YOUR APPLIANCE AND ACTIVATE YOUR PARTS GUARANTEE ON 08448 24 24 24