

Contents

Safety instructionS, 3

Safeguarding the environment, 5

Setting up your oven, 6

Operation instruction, 7

Troubleshooting, 11

Installation instruction, 12

SAFETY INSTRUCTIONS

GB

IMPORTANT TO BE READ AND OBSERVED

Before using the appliance read these safety instructions.

Keep them nearby close at hand for future reference.

These instructions and the appliance itself provide important safety warnings, to be observed at all times.

The manufacturer declines any liability for failure to observe these safety instructions, for inappropriate use of the appliance or incorrect setting of controls.

SAFETY WARNINGS

Very young (0-3 years) and young children (3-8 years) shall be kept away from the appliance unless continuously supervised. Children from 8 years old and above and persons with reduced physical, sensory or mental capabilities or lack of experience and knowledge can use this appliance only if they are supervised or have been given instructions on safe use and understand the hazards involved. Children must not play with the appliance. Cleaning and user maintenance must not be carried out by children without supervision.

WARNING: The appliance and its accessible parts become hot during use, children less than 8 year of age shall be kept away unless continuously supervised.

WARNING: Avoid touching heating elements or interior surface - risk of burns.

Never leave the appliance unattended during food drying.

If the appliance is suitable for probe usage, only use the temperature probe recommended for this oven.

WARNING: If the door or door seals are damaged, the oven must not be operated until it has been repaired by a competent person.

WARNING: Liquids and other foods must not be heated in sealed containers since they are liable to explode.

The microwave oven is intended for heating food and beverages. Drying of food or cloathing and heating of warming pads, slippers, sponges, damp cloth and similar may lead to risk of injury, ignition or fire.

When heating food in plastic or paper containers, keep an eye on the oven due to the possibility of ignition.

Microwave heating of beverages can result in delayed eruptive boiling, therefore care must be taken when handling the container.

The contents of feeding bottles and baby food jars shall be stirred or shaken and the temperature checked before consumption, in order to avoid burns.

Eggs in their shell and shole hard-boiled eggs should not be heated in microwave ovens since they may explode even after microwave heating has ended.

Only use utensils suitable for use in a microwave oven.

If smoke is emitted switch off or unplug the appliance and keep the door closed in order to stifle any flames.

Do not use your microwave oven for deep-frying, because the oil temperature cannot be controlled.

Keep clothes or other flammable materials away from the appliance, until all the components have cooled down completely. Overheated oils and fats catch fire easily. Always be vigilant when cooking food rich in fat, oil or when adding alcohol (e.g. rum, cognac, wine) - risk of fire.

Use oven gloves to remove pans and accessories, taking care not to touch the heating elements.

At the end of cooking, exercise caution when opening the door, by letting the hot air or steam exit gradually before accessing the appliance.

Do not obstruct hot air vents at the front of the oven.

PERMITTED USE

CAUTION: The appliance is not intended to be operated by means of an external timer or separate remote controlled system.

This appliance is intended to be used in household and similar applications such as:

- Staff kitchen areas in shops, offices and other working environments;
- Farm houses;
- By clients in hotels, motels and other residential environments;
- Bed and breakfast type environments.

This appliance is solely for domestic, not professional use.

Do not use the appliance outdoors.

Do not store explosive or flammable substances such as aerosol cans and do not place or use gasoline or other flammable

materials in or near the appliance: a fire may break out if the appliance is inadvertently switched on.

No other use is permitted (e.g. heating rooms).

INSTALLATION

The appliance must be handled and installed by two or more persons. Use protective gloves to unpack and install the appliance.

This appliance is intended to be used built-in. Do not use it freestanding.

Installation and repairs must be carried out by a qualified technician, in compliance with the manufacturer's instructions and local safety regulations. Do not repair or replace any part of the appliance unless specifically stated in the user manual.

Children should not perform installation operations. Keep children away during installation. Keep the packaging materials (plastic bags, polystyrene parts, etc.) out of reach of children, during and after the installation.

After unpacking the appliance, make sure that it has not been damaged during transport. In the event of problems, contact the dealer or your nearest After-sales Service. The appliance must be disconnected from the power supply before any installation operation.

During installation, make sure the appliance does not damage the power cable.

Only activate the appliance when the installation has been completed.

After installation, the bottom of the appliance must no longer be accessible.

Carry out all cabinet cutting works before fitting the appliance in the furniture and carefully remove all wood chips and sawdust. Do not obstruct the minimum gap between the worktop and the upper edge of the oven. Only remove the oven from its polystyrene foam base at the time of installation.

Do not install the appliance behind a decorative door - risk of fire.

After unpacking the appliance, make sure that the appliance door closes properly.

In the event of problems, contact the dealer or your nearest After-sales Service.

ELECTRICAL WARNINGS

For installation to comply with current safety regulations, an omnipolar switch with

minimum contact gap of 3 mm is required and the appliance must be earthed.

If the power cable is damaged, replace with an identical one. The power cable must only be replaced by a qualified technician in compliance with the manufacturer instruction and current safety regulations.

Contact an authorized service center.

It must be possible to disconnect the appliance from the power supply by unplugging it if plug is accessible, or by means of an accessible multi-pole switch installed upstream of the socket in conformity with national electrical safety standards.

The rating plate is on the front edge of the oven (visible when the door is open).

In case of replacement of power cable, contact an authorized service center.

If the fitted plug is not suitable for your socket outlet, contact a qualified technician.

The power cable must be long enough to connect the appliance, once fitted in its housing, to the main power supply. Do not pull the power supply cable.

Do not use extension leads, multiple sockets or adapters.

Do not operate this appliance if it has a damaged mains cord or plug, if it is not working properly, or if it has been damaged or dropped. Keep the cord away from hot surfaces.

The electrical components must not be accessible to the user after installation.

Do not touch the appliance with any wet part of the body and do not operate it when barefoot.

CLEANING AND MAINTENANCE

Never use steam cleaning equipment.

WARNING: Ensure that the appliance is switched off before replacing the lamp to avoid the possibility of electric shock.

Do not use harsh abrasive cleaners or sharp metal scrapers to clean the appliance door glass since they can scratch the surface, which may result in shattering of the glass.

WARNING: It is hazardous for anyone other than a competent person to carry out any service or repair operation that involves the removal of a cover which give protection against exposure to microwave energy.

Failure to maintain the oven in a clean condition could lead to deterioration of the

surface that could adversely affect the life of the appliance and possibly result in a hazardous situation.

The oven shall be cleaned regularly and any food deposits removed.

Wear protective gloves for cleaning and maintenance.

The appliance must be disconnected from the power supply before any maintenance operation.

Ensure the appliance is cooled down before carrying out any cleaning or maintenance operation.

SAFEGUARDING THE ENVIRONMENT

DISPOSAL OF PACKAGING MATERIALS

The packaging material is 100% recyclable and is marked with the recycle symbol . The various parts of the packaging must therefore be disposed of responsibly and in full compliance with local authority regulations governing waste disposal.

SCRAPPING OF HOUSEHOLD APPLIANCES

When scrapping the appliance, make it unusable by cutting off the power cable and removing the doors and shelves (if present) so that children cannot easily climb inside and become trapped.

This appliance is manufactured with recyclable  or reusable materials. Dispose of it in accordance with local waste disposal regulations.

For further information on the treatment, recovery and recycling of household electrical appliances, contact your competent local authority, the collection service for household waste or the store where you purchase the appliance.

This appliance is marked in compliance with European Directive 2012/19/EU, Waste Electrical and Electronic Equipment (WEEE).

By ensuring this product is disposed of correctly, you will help prevent potential negative consequences for the environment and human health, which could otherwise be caused by inappropriate waste handling of this product.



The symbol  on the product or on the accompanying documentation indicates that it should not be treated as domestic waste but must be taken to an appropriate collection center for the recycling of electrical and electronic equipment.

DECLARATION OF CONFORMITY

This appliance has been designed, constructed and distributed in compliance with the requirements of European Directives: LVD 2014/35/EU, EMC 2014/30/EU and RoHS 2011/65/EU.

This appliance, which is intended to come into contact with foodstuffs, complies with European Regulation n. 1935/2004.

This appliance meets the Eco Design requirements of European Regulations n. 65/2014, and n. 66/2014 in conformity to the European standard EN 60350-1.

SETTING UP YOUR OVEN

GB

Names of Oven Parts and Accessories

Remove the oven and all materials from the carton and oven cavity.

Your oven comes with the following accessories:

Glass tray	1
Turntable ring assembly	1
Instruction Manual	1

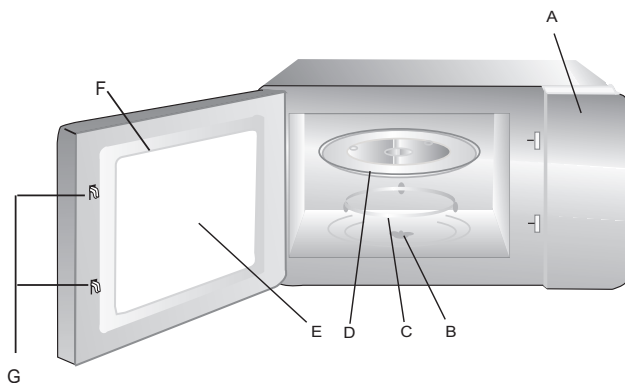

- A) Control panel
- B) Turntable shaft
- C) Turntable ring assembly
- D) Glass tray
- E) Observation window
- F) Door assembly
- G) Safety interlock system

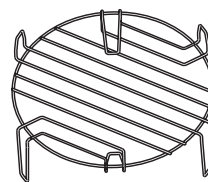
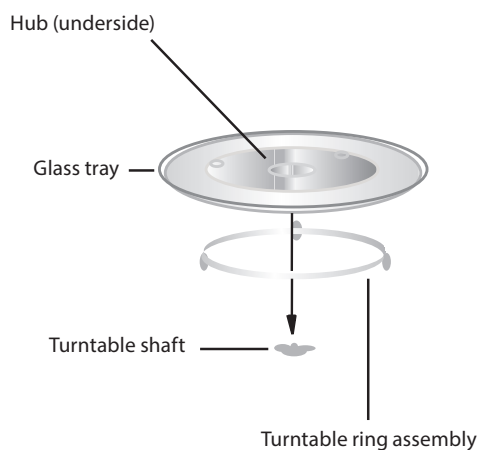

Grill Rack (Only for Grill series)

There are a number of accessories available on the market. Before you buy, ensure they are suitable for microwave use and resistant to oven temperatures.

Metallic containers for food or drink should never be used during microwave cooking.

Always ensure that foods and accessories do not come into contact with the inside walls of the oven.

Always ensure that the turntable is able to turn freely before starting the oven. Take care not to unseat the turntable whilst inserting or removing other accessories.



OPERATION INSTRUCTION

GB



This microwave oven uses modern electronic control to adjust cooking parameters to meet your needs better for cooking.

1. Clock Setting



When the microwave oven is ON, the oven will display "0:00", buzzer will ring once.

- 1) Press " / 

- 2) Turn "" to adjust the hour figures, the input time should be within 0--23 (24-hour).



- 3) Press " / 

- 4) Turn "" to adjust the minute figures, the input time should be within 0--59.

- 5) Press " / 

- Note:** 1) If the clock is not set, it would not function when powered.
2) During the process of clock setting, if you press "", the oven will go back to the previous status automatically.

2. Kitchen Timer

- 1) Press " /  twice, screen will display 00:00.







- 2) Turn "" to enter the correct time. (The maximum cooking time is 95 minutes.)

- 3) Press "

- 4) When the kitchen time is reached, the buzzer will ring 5 times.
If the clock be set (24-hour system), screen will display the current time.



Note: The kitchen Time is just a timer: it only has the "alarm clock" function.

3. Microwave Cooking

Press "" the screen will display "P100".
Press "" different times or turn "" to choose the power you want, and "P100", "P80", "P50", "P30" or "P10" will display for each added press. Then press "" to confirm, and turn "" to set cooking time from 0:05 to 95:00.
Press "" again to start cooking.

Example: If you want to use 80% microwave power to cook for 20 minutes, you can operate the oven as the following steps.

- 1) Press "" once, the screen display "P100".







- 2) Press "" once again or turn "" to choose 80% microwave power.

- 3) Press "

- 4) Turn "" to adjust the cooking time until the oven displays "20:00".

- 5) Press "

4. Grill or Combi. Cooking

Press "" the screen will display "G-1", and press "" different times or turn the "" to choose the power you want, and "G", "C-1", "C-2", "C-3" or "C-4" will display for each added press. Then press "" to confirm, and turn "" to set cooking time "" again to start cooking.

Example: If you want to use grill power to cook for 10 minutes, you can operate the oven as the following steps.

- 1) Press "" once, the screen display "G-1".

- 2) Press "

- 3) Turn "" to adjust the cooking time until the oven displays "10:00".

- 4) Press "

Note: When half the grill time has passed the oven sounds twice: this is normal. In order to have a better effect of grilling food, you should turn the food over and close the door, and then press "" to continue cooking.
If no operation, the oven will continue working.

Microwave Power Chart

Press	Once	Twice	Thrice	4 times	5 times	10%
Microwave Power	100%	80%	50%	30%	10%	



Note: Combination instructions

Instructions	Display	Microwave	Grill	Convection
1	C-1	•		•
2	C-2	•	•	
3	C-3		•	•
4	C-4	•	•	•

5. Convection Cooking (with preheating function)

The convection cooking can let you to cook the food as a traditional oven. Microwave is not used. It is recommended that you should preheat the oven to the appropriate temperature before placing the food in the oven.

1) Press the " " key once, "130" flash.

2) Keep pressing " " or turn " " to select the convection function.

Note: the temperature can be chosen from 130 degrees to 220 degrees.

3) Press the " " to confirm the temperature .

4) Press the " " to start preheating.

When the preheating temperature arrives, the buzzer will sound twice to remind you to put the food into the oven. And the preheated temperature is displayed and flash.

5) Put the food into the oven and close the door.



Turn " " to adjust the cooking time. (The maximum setting time is 95 minutes.)

6) Press the " " key to start cooking.

Note: a. Cooking time cannot be input until the preheating temperature arrives. If the temperature arrives, door must be opened to input the cooking time.
b. If the time not input in 5 minutes, the oven will stop preheating. The buzzer sound five times and turn back to waiting states.

6. Convection Cooking (without pre-heating function)

1) Press the " " key once, "130" flash.

2) Keep pressing " " or turn " " to select the convection function.

Note: the temperature can be chosen from 130 degrees to 200 degrees.

3) Press the " " to confirm the temperature.

4) Turn " " to adjust the cooking time. (The maximum setting time is 95 minutes).

5) Press the " " key to start cooking.



7. Multi-Stage Cooking

Two stages can be maximally set. If one stages is defrosting, it should be put in the first stage. The buzzer will ring once after each stage and the next stage will begin.

Note: Auto menu and preheating cannot be set as one of the multi-stage.

Example: if you want to defrost the food for 5 minutes, then to cook with 80% microwave power for 7 minutes.

The steps are as following:

1) Press "   " twice, the screen will display "d-2".

2) Turn " " to adjust the defrost time of 5 minutes.

3) Press " " once.



4) Turn " " to choose 80% microwave power till "P80" display.

5) Press " " to confirm.

6) Turn " " to adjust the cooking time of 7 minutes.

7) Press " " to start cooking.

8. Speedy Cooking

- 1) In waiting state, press " " key to cook with 100% power level for 30 seconds. Each press on the same key can increase 30 seconds. The maximum cooking time is 95 minutes.
- 2) During microwave, grill, convection, combination and defrost by weight, press " " key to cook with 100% power level for 30 seconds.

Each press on the same key can increase 30 seconds.



Note: This function cannot work under defrost by W.T., multi-stage or auto menu cooking.

9. Speedy Microwave Cooking

In waiting state, turn " " left to choose cooking time directly then press " " key to cook with 100% microwave power.

Note: This program can be set as one of multi-stage.



10. Auto Menu

- 3) In waiting state, turn " " right to choose the function wanted, and "A1", "A2", "A3"... "A10" will be displayed.
- 4) Press " " to confirm the menu you need.
- 5) Turn " " to choose the weight of menu, and "g" indicator will light.



- 6) Press " " to start cooking.

Note: When you choose A9 cake, please do not put the cake into the oven at the beginning. The oven needs to be preheated to 180 degree first. After several minutes, the buzzer sounds twice to remind you to put the cake into the oven. After putting the cake in the oven, please press " " again. The timer will count down, and the cake will be cooked perfectly.





11. Defrost by W.T.

- 1) Press " " pad once, the oven will display "d-1".
- 2) Turn " " to select the weight of food. At the same time, "g" will lights, the weight should be 100-2000g.
- 3) Press " " to start defrosting.



12. Defrost by Time



- 1) Press " " key twice, the oven will display "d-2".
- 2) Turn " " to select the cooking time. The maximum setting time is 95 minutes.
- 3) Press " " key to start defrosting.

13. Inquiring Function



- 1) During cooking state, press " " to check the current time. It will be displayed for 2-3 seconds.
- 2) In cooking state, press " ", " " or " ", the current power or temperature set will be displayed for 2-3 seconds.

14. Lock-out Function for Children

Lock: In waiting state, press " " for 3 seconds, there will be a long "beep" denoting entering into the children-lock state and " " indicator will light. screen will display current time or 0:00.

Lock quitting: In locked state, press " " for 3 seconds, there will be a long "beep" denoting that the lock is released, and " " indicator will disappear.

15. Specification

- 1) The buzzer will sound once when turning the knob at the beginning.
- 2) " " must be pressed to continue cooking if the door is opened during cooking.
- 3) Once the cooking programme has been set, " " is not pressed in 5 minutes. The current time will be displayed. The setting will be cancelled.
- 4) The buzzer sounds once by efficient press, inefficient press will be no response.
- 5) The buzzer will sound five times to remind you when cooking is finished.

Auto menu Chart

Menu	Weight (g)	Display	Power
A-1 Pizza	200	200	C-4
	300	300	
	400	400	
A-2 Potato	1 (about 230 g)	1	100%
	2 (about 460 g)	2	
	3 (about 690 g)	3	
A-3 Meat	150	150	100%
	300	300	
	450	450	
	600	600	
A-4 Fish	150	150	80%
	250	250	
	350	350	
	450	450	
	650	650	
A-5 Vegetable	150	150	100%
	350	350	
	500	500	
A-6 Beverage / Coffee	1 (about 240 g)	1	100%
	2 (about 480 g)	2	
	3 (about 720 g)	3	
A-7 Pasta	50 (with drinking water 450 ml)	50	80%
	100 (with drinking water 800 ml)	100	
	150 (with drinking water 1200 ml)	150	
A8 Popcorn	50	50	100%
	100	100	
A9 Cake	475	475	Preheat at 180 degrees
A-10 Chicken	500	500	C-4
	750	750	
	1000	1000	
	1200	1200	

TROUBLESHOOTING

GB

Trouble	Possible Cause	Remedy
Oven cannot be started	Power cord not plugged in	Plug in the product
Oven does not heat	Door not closed	Close door

HOW TO OBTAIN THE USE AND CARE GUIDE

>  [www](http://www.docs.indesit.eu) Download the Use and Care Guide from our website **docs.indesit.eu** (you can use this QR Code), specifying the product's commercial code.



> Alternatively, contact our Client After-sales Service.

CONTACTING OUR AFTER-SALES SERVICE

You can find our contact details in the warranty manual. When contacting our Client After-sales Service, please state the codes provided on your product's identification plate.

