

SH33K S
SH33W S
SH33X S
SHS33X S
SHS33XK S
SHS33CX S
KSO33CX S
SD33X
SD33

GB

English

Operating Instructions

OVEN

Contents

Operating Instructions,1
Warnings,2
Description of the appliance,3
Installation,4
Electrical Connection,5
Start-up and use,6
Modes,6
The electronic programmer*,8
Precautions and tips,9
Maintenance and care,9
Afetr Sales Service,11
Guarantee,12

 **Hotpoint**

Please phone us on
08448 24 24 24
to activate your
guarantee

Warnings

WARNING: The appliance and its accessible parts become hot during use. Care should be taken to avoid touching heating elements. Children less than 8 years of age shall be kept away unless continuously supervised. This appliance can be used by children aged from 8 years and above and persons with reduced physical, sensory or mental capabilities or lack of experience and knowledge if they have been given supervision or instruction concerning use of the appliance in a safe way and understand the hazards involved. Children shall not play with the appliance. Cleaning and user maintenance shall not be made by children without supervision.

Do not use harsh abrasive cleaners or sharp metal scrapers to clean the oven door glass since they can scratch the surface, which may result in shattering of the glass.

Never use steam cleaners or pressure cleaners on the appliance.

WARNING: Ensure that the appliance is switched off before replacing the lamp to avoid the possibility of electric shock.

! When you place the rack inside, make sure that the stop is directed upwards and in the back of the cavity.

Description of the appliance

Overall view

1. POSITION 1
2. POSITION 2
3. POSITION 3
4. POSITION 4
5. POSITION 5
6. GUIDES for the sliding racks
7. DRIPPING PAN
8. GRILL
9. Control panel

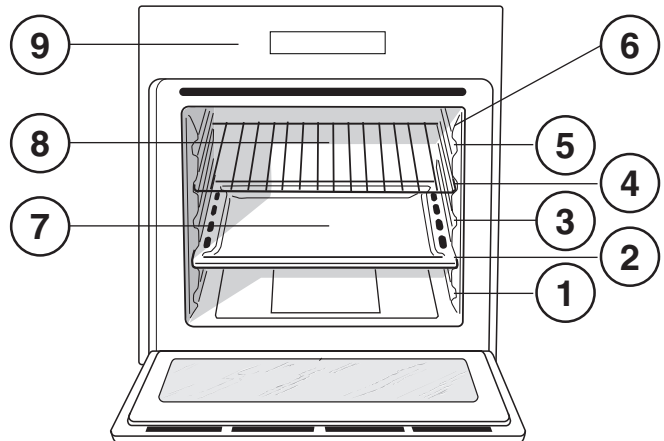

Control panel

1. SELECTOR Knob
2. ELECTRONIC programmer*
3. VARIABLE GRILL Knob
4. Indicator light THERMOSTAT

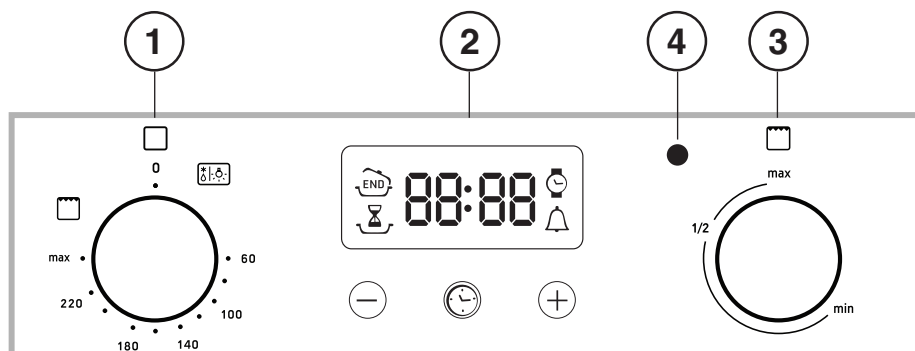

* Only available in certain models.

Installation

! Please keep this instruction booklet in a safe place for future reference. If the appliance is sold, given away or moved, please make sure the booklet is also passed on to the new owners so that they may benefit from the advice contained within it.

! Please read this instruction manual carefully: it contains important information concerning the safe operation, installation and maintenance of the appliance.

Positioning

! Do not let children play with the packaging material; it should be disposed of in accordance with local separated waste collection standards (see Precautions and tips).

! The appliance must be installed by a qualified professional in accordance with the instructions provided. Incorrect installation may damage property or cause harm to people or animals.

Built-in appliances

Use an appropriate cabinet to ensure that the appliance operates properly:

- The panels adjacent to the oven must be made of heat-resistant material.
- Cabinets with a veneer exterior must be assembled with glues which can withstand temperatures of up to 100°C.
- To install the oven **under the counter** (see diagram) or in a **kitchen unit**, the cabinet must have the following dimensions:

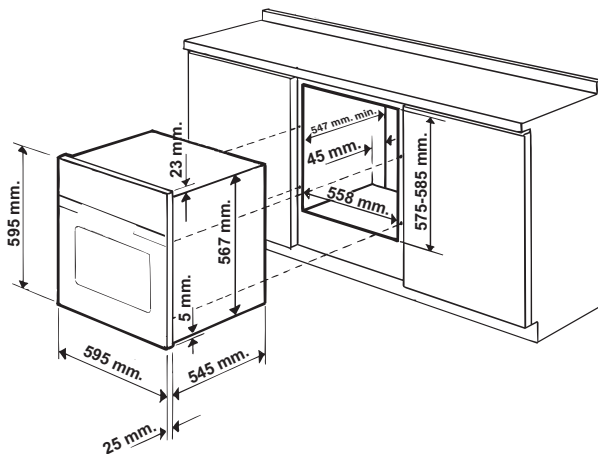

! The appliance must not come into contact with electrical parts once it has been installed. The indications for consumption given on the data plate have been calculated for this type of installation.

Ventilation

To ensure adequate ventilation, the back panel of the cabinet must be removed. It is advisable to install the oven so that it rests on two strips of wood, or on a completely flat surface with an opening of at least 45 x 560 mm (see diagrams).

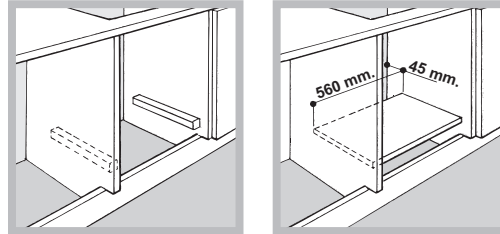

Centring and fixing

Position the 4 tabs on the side of the oven so that they are lined up with the 4 holes on the outer frame. Adjust the tabs according to the thickness of the cabinet side panel, as shown below:

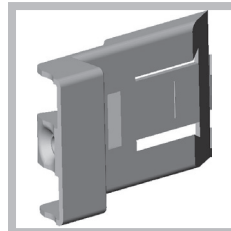

20 mm thick: take off the removable part of the tab (see diagram).;

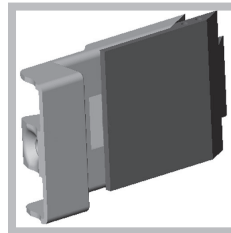

18 mm thick: use the first groove, which has already been set in the factory (see diagram).

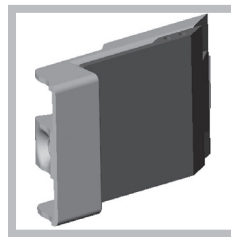

16 mm thick: use the second groove (see diagram).

Secure the appliance to the cabinet by opening the oven door and putting 4 screws into the 4 holes on the outer frame.

! All parts which ensure the safe operation of the appliance must not be removable without the aid of a tool.

Electrical Connection

The electrical connection to the mains must be made on the appliance. The power voltage and frequency are as indicated on the rating plate.

! THIS APPLIANCE MUST BE EARTHED.

Fitting the power supply cable

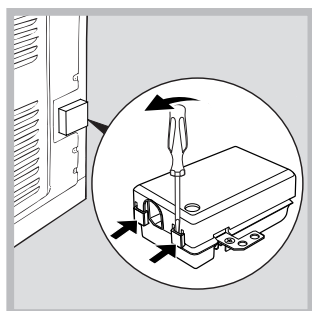

1. Open the terminal board by inserting a screwdriver into the side tabs of the cover. Use the screwdriver as a lever by pushing it down to open the cover (see diagram)

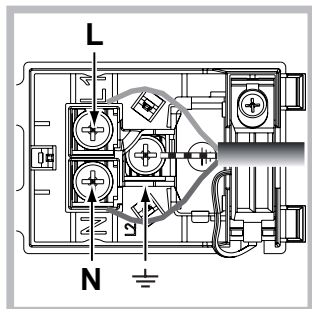

2. Install the power supply cable by loosening the cable clamp screw and the three wire contact screws L-N-.

Connect the wires to the corresponding terminals: the Blue wire to the terminal marked (N), the Brown wire to the terminal marked (L) and the Yellow/Green wire to the terminal marked (see diagram).

- Secure the cable by fastening the clamp screw.
- Close the cover of the terminal board.

Electrical Connection:

Voltage Frequency: see data plate

Fuse Section: 16A

Supply cable: 3x1.5mm²

You can connect your oven to the system means of a terminal board. Refer to above information for the minimal cable sections and the calibration of the protective elements according to the connection.

If the appliance is installed **with a junction box**, an **omnipolar circuit breaker** - with a minimum contact opening of 3mm - should be installed between the appliance and the mains.

Power cable supply connection to the electrical mains:

We recommend you use a power supply cable which is long enough to allow you to take the oven out of its recess in the event of maintenance operations (only use HAR - H 05 - RRF quality cables fitted with a plug conforming to the regulations in force).

The plug must be accessible at all times.

Unplug the appliance before all operations, even when replacing the oven lamp.
Using the appliance without correct earthing is highly dangerous.

! After connecting the appliance to the flexible cable, tighten all the screws on the terminal board.

APPLIANCE SPECIFICATIONS	
Dimensions*	width 43.5 cm height 32,4 cm depth 41.5 cm
Volume*	59 l
Dimensions**	width 45.5 cm height 32,4 cm depth 41.5 cm
Volume**	62 l
Electrical connections	voltage: 230 - 240 V~ 50/60 Hz or 50 Hz(see data plate) maximum power absorbed 2250-2400 W
ENERGY LABEL	Directive 2002/40/EC on the label of electric ovens. Standard EN 50304 Declared energy consumption for Forced convection Class - heating mode: Fan assisted
	This appliance conforms to the following European Economic Community directives: - 2006/95/EEC of 12/12/06 (Low Voltage) and subsequent amendments; - 2004/108/EEC of 15/12/04 (Electromagnetic Compatibility) and subsequent amendments; - 93/68/EEC of 22/07/93 and subsequent amendments. - 2012/19/EC and subsequent amendments.

* Only for models with drawn rails.

** Only for models with wire rails.

Start-up and use

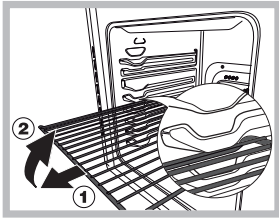

WARNING! The oven is provided with a stop system to extract the racks and prevent them from coming out of the oven (1). As shown in the drawing, to extract them completely, simply lift the racks, holding them on the front part, and pull (2).

! The first time you use your appliance, heat the empty oven with its door closed at its maximum temperature for at least half an hour. Make sure that the room is well ventilated before switching the oven off and opening the oven door. The appliance may emit a slightly unpleasant odour caused by protective substances used during the manufacturing process burning away.

Starting the oven

1. Select the desired cooking mode by turning the SELECTOR knob.
2. Select the desired temperature with SELECTOR knob. See the Cooking advice table for cooking modes and the suggested cooking temperatures (see Cooking Modes)
3. When preheating is finished, the THERMOSTAT indicator light will stay on: place the food in the oven.
4. During cooking you may do the following:
 - change the cooking mode by turning the SELECTOR knob to the grill icon. Then select the power of the grill with the grill knob.
 - change the temperature by turning the SELECTOR knob.
 - stop cooking by turning the SELECTOR knob to the "0" position.

! Whilst using tag oven for conventional VARIABLE GRILL knob must be set with "MAX" in line with the reference mark on the control panel.

! Never put objects directly on the oven bottom to avoid damaging the enamel coating.

! Always place cookware on the rack(s) provided.

Cooling ventilation

In order to cool down the external temperature of the oven, some models are fitted with a cooling fan that blows out air between the control panel and the oven door.

! Once the cooking has been completed, the cooling fan remains on until the oven has cooled down sufficiently.

Oven light

It goes on when selecting  with the SELECTOR knob. It stays on when a cooking mode is selected.

Modes

! GRILL (recommended: set only to MAX power level);

Thermostatically controlled oven (Fan Assisted Mode)

When the SELECTOR knob is turned in a clockwise

direction to the symbol  the fan and oven light will come on to assist in the defrosting of frozen food. Rotating further to the complete range of temperatures shown on the dial you can choose which is most suitable for the food you are going to cook. The temperature is reached automatically and controlled by the oven thermostat (from 60°C to MAX).

! Whilst using tag oven for conventional VARIABLE GRILL knob must be set with "MAX" in line with the reference mark on the control panel.



GRILL mode

The top heating element comes on. The extremely high and direct temperature of the grill makes it possible to brown the surface of meats and roasts while locking in the juices to keep them tender. The grill is also highly recommended for dishes that require a high temperature on the surface: such as beef steaks, veal, rib steak, filets, hamburgers etc... Some grilling examples are included in the "Practical Cooking Advice" paragraph. Always cook in this mode with the oven door closed.

To operate the grill:

1. Turn the oven SELECTOR knob clockwise until the required grilling symbol is in line with the mark on the control panel. The element is now "on".
2. The VARIABLE GRILL knob can now be operated to select the required heat.

Practical cooking advice

! Do not place racks in position 1 and 5 during fan-assisted cooking. Excessive direct heat can burn temperature sensitive foods.

! In the GRILL cooking modes, place the dripping pan in position 1 to collect cooking residues (fat and/or grease).

GRILL

- Insert the rack in position 3 or 4. Place the food in the centre of the rack.

* Only available in certain models.

- We recommend that you set the maximum power level. The top heating element is regulated by a thermostat and may not always be on.

PIZZA

- Use a light aluminium pizza pan. Place it on the rack provided.
For a crispy crust, do not use the dripping pan (prevents crust from forming by extending cooking time).
- If the pizza has a lot of toppings, we recommend adding the mozzarella cheese on top of the pizza halfway through the cooking process.

Cooking advice table

Foods	Weight. (wt)	Rack position	Temperature (°C)	Variable grill	Pre-heating time (min)	Cooking time (min.)
Pasta						
Lasagne	2.5	3	210		-	75-80
Cannelloni	2.5	3	210	MAX	-	75-80
Oven-baked noodles	2.5	3	210		-	75-80
Meat						
Veal	1.7	3	230		-	85-90
Chicken	1.5	3	220		-	110-115
Turkey	3.0	3	MAX	MAX	-	95-100
Duck	1.8	3	230		-	120/125
Rabbit	2	3	230		-	105/110
Pork	2.1	3	230		-	100/110
Lamb	1.8	3	230		-	90-95
Fish						
Mackerel	1.1	3	210-230		-	55-60
Dentex	1.5	3	210-230	MAX	-	60-65
Trout baked in paper	1.0	3	210-230		-	40-45
Pizza						
Napolitan	1.0	3	MAX	MAX	15	30-35
Cake						
Biscuits	0.5	3	180		15	30-35
Tarts	1.1	3	180	MAX	15	30-35
Chocolate cake	1	3	200		15	45-50
Raised Cakes	1	3	200		15	50/55
Grill cooking						
Toast	n.° 4	4			5	5-6
Pork chops	1.5	4		3/4	5	20-30
Mackerel	1.1	4			5	20-30

The cooking times listed above are intended as guidelines only and may be modified according to personal tastes.

The electronic programmer*

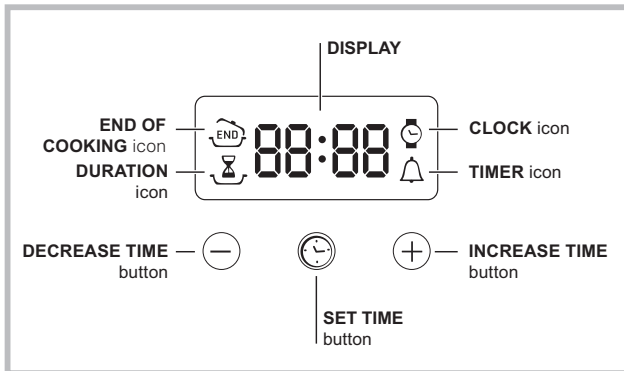

Setting the clock

! The clock may be set when the oven is switched off or when it is switched on, provided that a the end time of a cooking cycle has not been programmed previously.

After the appliance has been connected to the mains, or after a blackout, the icon and the four numerical digits on the DISPLAY will begin to flash.

1. Press the button several times until the icon and the four digits on the display begin to flash.
2. Use the "+" and "-" buttons to adjust the time; if you press and hold either button, the display will scroll through the values more quickly, making it quicker and easier to set the desired value.
3. Wait for 10 seconds or press the button again to finalise the setting.

Setting the timer

! This function does not interrupt cooking and does not affect the oven; it is simply used to activate the buzzer when the set amount of time has elapsed.

1. Press the button several times until the icon and the three digits on the display begin to flash.
2. Use the "+" and "-" buttons to set the desired time; if you press and hold either button, the display will scroll through the values more quickly, making it quicker and easier to set the value.
3. Wait for 10 seconds or press the button again to finalise the setting.

The display will then show the time as it counts down. When this period of time has elapsed the buzzer will be activated.

Programming cooking

! A cooking mode must be selected before programming can take place.

Programming the cooking duration

1. Press the button several times until the icon and the three digits on the DISPLAY begin to flash.
2. Use the "+" and "-" buttons to set the desired duration; if you press and hold either button, the display will scroll through the values more quickly, making it quicker and easier to set the value.

3. Wait for 10 seconds or press the button again to finalise the setting.

4. When the set time has elapsed, the text END appears on the DISPLAY, the oven will stop cooking and a buzzer sounds. Press any button to stop it.

- For example: it is 9:00 a.m. and a time of 1 hour and 15 minutes is programmed. The programme will stop automatically at 10:15 a.m.

Setting the end time for a cooking mode

! A cooking duration must be set before the cooking end time can be scheduled.

1. Follow steps 1 to 3 to set the duration as detailed above.
2. Next, press the button until the and the four digits on the DISPLAY begin to flash.
3. use the "+" and "-" buttons to adjust the cooking end time; if you press and hold either button, the display will scroll through the values more quickly, making it quicker and easier to set the desired value.
4. Wait for 10 seconds or press the button again to finalise the setting.
5. When the set time has elapsed, the text END appears on the DISPLAY, the oven will stop cooking and a buzzer sounds. Press any button to stop it.

Programming has been set when the and buttons are illuminated. The DISPLAY shows the cooking end time and the cooking duration alternately.

- For example: It is 9:00 a.m. and a duration of 1 hour has been programmed. 12:30 is scheduled as the end time. The programme will start automatically at 11:30 a.m.

Cancelling a programme

To cancel a programme:

- press the button until the icon corresponding to the setting you wish to cancel and the digits on the display are no longer flashing. Press the "-" button until the digits 00:00 appear on the display.
- Press and hold the "+" and "-" buttons; this will cancel all the settings selected previously, including timer settings.

* Only available in certain models.

Precautions and tips

! This appliance has been designed and manufactured in compliance with international safety standards. The following warnings are provided for safety reasons and must be read carefully.

General safety

- The appliance was designed for domestic use inside the home and is not intended for commercial or industrial use.
- The appliance must not be installed outdoors, even in covered areas. It is extremely dangerous to leave the appliance exposed to rain and storms.
- When moving or positioning the appliance, always use the handles provided on the sides of the oven.
- Do not touch the appliance while barefoot or with wet or damp hands and feet.
- **The appliance must be used by adults only for the preparation of food, in accordance with the instructions provided in this booklet. Any other use of the appliance (e.g. for heating the room) constitutes improper use and is dangerous. The manufacturer may not be held responsible for any damage caused as a result of improper, incorrect and unreasonable use of the appliance.**
- **Do not touch the heating elements or certain parts of the oven door when the appliance is in use; these parts become extremely hot. Keep children well away from the appliance.**
- Make sure that the power supply cables of other electrical appliances do not come into contact with the hot parts of the oven.
- The ventilation and heat dispersal openings must never be obstructed.
- Always grip the oven door handle in the centre: the ends may be hot.
- Always use oven gloves when placing cookware in the oven or when removing it.
- Do not use aluminium foil to line the bottom of the oven.
- Do not place flammable materials in the oven: if the appliance is switched on accidentally, the materials could catch fire.
- When unplugging the appliance, always pull the plug from the mains socket; do not pull on the cable.
- Do not perform any cleaning or maintenance work without having disconnected the appliance from the electricity mains.
- If the event of malfunctions, under no circumstances should you attempt to perform the repairs yourself. Contact an authorised Service Centre (see Assistance).
- Do not rest objects on the open oven door.
- Do not let children play with the appliance.
- The appliance should not be operated by people (including children) with reduced physical, sensory or mental capacities, by inexperienced individuals or by anyone who is not familiar with the product. These individuals should, at the very least, be supervised by someone who assumes responsibility for their safety or receive preliminary instructions relating to the operation of the appliance.
- **The appliance is not intended to be operated by means of an external timer or separate remote-control system.**

Disposal

- When disposing of packaging material: observe local legislation so that the packaging may be reused.
- The European Directive 2012/19/EC on Waste Electrical and Electronic Equipment (WEEE), requires that old household electrical appliances must not be disposed of in the normal unsorted municipal waste stream. Old appliances must be collected separately in order to optimise the recovery and recycling of the materials they contain and reduce the impact on human health and the environment. The crossed out “wheeled bin” symbol on the product reminds you of your obligation, that when you dispose of the appliance it must be separately collected. Consumers should contact their local authority or retailer for information concerning the correct disposal of their old appliance.

Respecting and conserving the environment

- You can help to reduce the peak load of the electricity supply network companies by using the oven in the hours between late afternoon and the early hours of the morning. The cooking mode programming options, the “delayed cooking” mode (see Cooking modes) and “delayed automatic cleaning” mode (see Care and Maintenance) in particular, enable the user to organise their time efficiently.
- Check the door seals regularly and wipe them clean to ensure they are free of debris so that they adhere properly to the door, thus avoiding the dispersal of heat.

Maintenance and care

Switching the appliance off

Disconnect your appliance from the electricity supply before carrying out any work on it.

Cleaning the appliance

- Slight differences in colour on the front of the oven are due to the different materials used, i.e. glass, plastic or metal.
- Any shady areas resembling grooves on the oven door glass are caused by reflections from the oven light.
- The enamel is branded at very high temperatures. This process may cause colour variations. This is normal and will not affect appliance operation in any way. The thin edges of the sheet metal cannot be entirely enamelled and may therefore appear to be unfinished. This will not affect the rust protection.
- The stainless steel or enamel-coated external parts and the rubber seals may be cleaned using a sponge that has been soaked in lukewarm water and neutral soap. Use specialised products for the removal of stubborn stains. After cleaning, rinse and dry thoroughly. Do not use abrasive powders or corrosive substances.
- The inside of the oven should ideally be cleaned after each use, while it is still lukewarm. Use hot water and detergent, then rinse well and dry with a soft cloth. Do not use abrasive products.
- All accessories can be washed like everyday crockery, and are even dishwasher safe.

- We recommend that detergents are not sprayed directly onto the control panel, but that a sponge is used instead.

! Never use steam cleaners or pressure cleaners on the appliance.

Cleaning the oven door

Clean the glass part of the oven door using a sponge and a non-abrasive cleaning product, then dry thoroughly with a soft cloth. Do not use rough abrasive material or sharp metal scrapers as these could scratch the surface and cause the glass to crack.

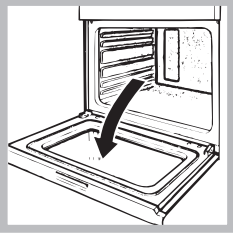

For more thorough cleaning purposes, the oven door may be removed:

1. Open the oven door fully (see diagram).

2. Use a screwdriver to lift up and turn the small levers **F** located on the two hinges (see diagram).

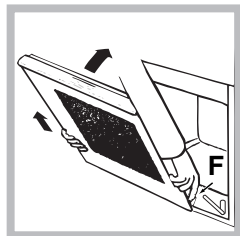
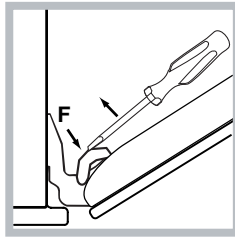
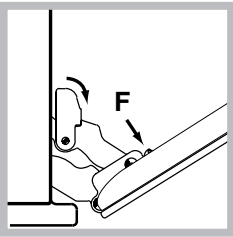

3. Grip the door on the two external sides and close it approximately half way. Unlock the door by pressing on the clamps **F**, then pull the door towards you lifting it out of its seat (see diagram). To replace the door, reverse this sequence.

VERY HOT SURFACES

Food or grease on these surfaces could cause smoke and possibly even burn

YOU MUST KEEP THE OVEN AND GRILL CAVITIES CLEAN

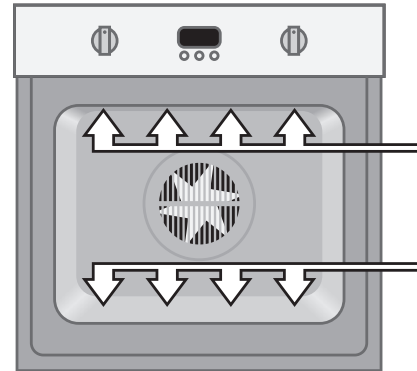

Inspecting the seals

Check the door seals around the oven regularly. If the seals are damaged, please contact your nearest Service Centre (see Assistance). We recommend that the oven is not used until the seals have been replaced.

Replacing the light bulb

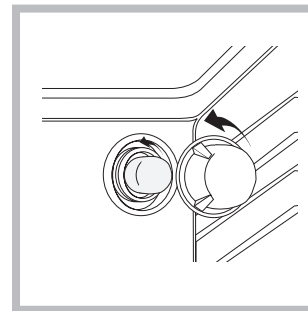

To replace the oven light bulb:

1. Remove the glass cover of the lamp-holder.
2. Remove the light bulb and replace it with a similar one: Wattage 25 W, cap E 14.
3. Replace the glass cover (see diagram).

! Do not use the oven lamp as/for ambient lighting.

Side and rear catalytic liners*

These are panels coated with a special enamel, which is able to absorb the fat released by food as it cooks. This enamel is quite strong, so that the various accessories (racks, dripping pans, etc.) can slide along them without damaging them. White marks may appear on the surfaces; these are not a cause for concern.

Nevertheless, the following should be avoided:

- scraping the enamel with sharp objects (a knife, for example);
- using detergents or abrasive materials.

* Only available on certain models.

Afetr Sales Service

No one is better placed to care for your Hotpoint appliance during the course of its working life than us – the manufacturer.

Essential Contact Information

Hotpoint Service

We are the largest service team in the country offering you access to 400 skilled telephone advisors and 1000 fully qualified engineers on call to ensure you receive fast, reliable, local service.

UK: 08448 224 224
Republic of Ireland: 0818 313 413
www.hotpointservice.co.uk

Please note: Our advisors will require the following information:

Model number:

Serial number:

Parts and Accessories

We supply a full range of genuine replacement parts as well as accessory products that protect and hygienically clean your appliance to keep it looking good and functioning efficiently throughout its life.

UK: 08448 225 225
Republic of Ireland: 0818 313 413
www.hotpointservice.co.uk

Appliance Registration

We want to give you additional benefits of Hotpoint ownership. To activate your free 5 year parts guarantee you must register your appliance with us.

UK: 08448 24 24 24
Republic of Ireland: 01 230 0800
www.hotpointservice.co.uk

Indesit Company UK Ltd. Morley Way, Peterborough, PE2 9JB
Indesit Company Unit 49 Airways Industrial Estate, Dublin 17

Recycling and Disposal Information

As part of Hotpoint's continued commitment to helping the environment, Hotpoint reserves the right to use quality, recycled components to keep down customer costs and minimise material wastage.

Please dispose of packaging and old appliances carefully. To minimise the risk of injury to children, remove the door, plug, and cut the mains cable off flush with the appliance. Dispose of these parts separately to ensure that the appliance can no longer be plugged into mains socket, and the door cannot be locked shut.

Guarantee

12 months Parts and Labour Guarantee

Your appliance has the benefit of our manufacturer's guarantee, which covers the cost of breakdown repairs for twelve months from the date of purchase.

This gives you the reassurance that if, within that time, your appliance is proven to be defective because of either workmanship or materials, we will, at our discretion, either repair or replace the appliance at no cost to you.

This guarantee is subject to the following conditions:

- The appliance has been installed and operated correctly and in accordance with our operating and maintenance instructions.
- The appliance is used only on the electricity or gas supply printed on the rating plate.
- The appliance has been used for normal domestic purposes only.
- The appliance has not been altered, serviced, maintained, dismantled, or otherwise interfered with by any person not authorised by us.
- Any repair work must be undertaken by us or our appointed agent.
- Any parts removed during repair work or any appliance that is replaced become our property.
- The appliance is used in the United Kingdom or Republic of Ireland.

The guarantee does not cover:

- Damage resulting from transportation, improper use, neglect or interference or as a result of improper installation
- Replacement of any consumable item or accessory. These included but not limited to: plugs, cables, batteries, light bulbs, fluorescent tubes and starters, covers and filters.
- Replacement of any removable parts made of glass or plastic.

THIS GUARANTEE WILL NOT APPLY IF THE APPLIANCE HAS BEEN USED IN COMMERCIAL OR NON-DOMESTIC PREMISES.

5 Year Parts Guarantee

Hotpoint also offers you a free 5 year parts guarantee. This additional guarantee is conditional on you registering your appliance with us and the parts being fitted by one of our authorised engineers. There will be a charge for our engineer's time. To activate the extra parts warranty on your appliance, simply call our registration line on **08448 24 24 24 (Republic of Ireland 01 230 0800)**

Extended Guarantees

We offer a selection of protection plans that enable you to fully cover yourself against the expense of repair bills for the life of your policy. To find the ideal plan for you please call our advice line on **08448 226 226 (Republic of Ireland 01 230 0233)**.

Free Helpdesk Service

We have a dedicated team who can provide free advice and assistance with your appliance if you experience any technical difficulties within the first 90 days of ownership. Simply call our Hotpoint Service Hotline on **08448 224 224 (Republic of Ireland 0818 313 413)** for telephone assistance, or, where necessary, to arrange for an engineer to call.