



POWERGLIDE[®]
CORDLESS
USER GUIDE

1538 SERIES

IMPORTANT SAFETY INSTRUCTIONS

READ ALL INSTRUCTIONS BEFORE USING YOUR VACUUM.

When using an electrical appliance, basic precautions should be observed, including the following:

WARNING

TO REDUCE THE RISK OF FIRE, ELECTRIC SHOCK, OR INJURY:

- » This appliance can be used by children aged from 8 years and above and persons with reduced physical, sensory or mental capabilities or lack of experience and knowledge if they have been given supervision or instruction concerning use of the appliance in a safe way and understand the hazards involved. Cleaning and user maintenance shall not be made by children without supervision.
- » Children should be supervised to ensure that they do not play with the appliance.
- » If charger supply cable is damaged, it must be replaced by the manufacturer, its service agent, or similarly qualified person in order to avoid a hazard.
- » Keep hair, loose clothing, fingers, and all parts of body away from openings and moving parts of the appliance and its accessories.
- » Unplug from electrical socket when not charging.
- » Do not allow to be used as a toy.
- » Use only as described in this user guide.
- » Use only BISSELL recommended attachments.
- » Do not use with damaged cable or plug for charger.
- » Do not immerse in water or liquid.
- » If appliance is not working as it should, has been dropped, damaged, left outdoors, or dropped into water; do not attempt to operate it and return it to a service center.
- » Do not pull or carry charger by cable.
- » Keep charger cable away from heated surfaces.
- » Do not unplug charger by pulling on cable.
- » To unplug charger, grasp the plug, not the cable.
- » Do not handle charger plug or appliance with wet hands.
- » Do not put any object into openings.
- » Do not use with any opening blocked; keep free of dust, lint, hair, and anything that may reduce air flow.
- » Use extra care when cleaning on stairs.
- » Do not use to pick up flammable or combustible liquids, such as petroleum, or use in areas where they may be present.
- » Do not pick up toxic material (chlorine bleach, ammonia, drain cleaner, etc.)
- » Do not use appliance in an enclosed space filled with vapours given off by oil base paint, paint thinner, some mothproofing substances, flammable dust, or other explosive or toxic vapours.
- » Do not pick up hard or sharp objects such as glass, nails, screws, coins, etc.
- » Use only on dry, indoor surfaces.
- » Keep appliance on a level surface.
- » Do not pick up anything that is burning or smoking, such as cigarettes, matches, or hot ashes.
- » Do not use without dust tank and/or filters in place.
- » Do not use outdoors or on wet surfaces
- » Do not leave machine running in the same spot without handle fully upright.
- » Turn off all controls before connecting or disconnecting the TurboBrush® Tool or Pet TurboEraser® Tool.
- » Only use the rechargeable Li-ion battery pack and charging base supplied by BISSELL.
- » If the appliance is to be stored unused for a long period, the battery pack should be removed.
- » Battery pack and charger base output terminals are not to be short-circuited.
- » The charger is only for charging the rechargeable Li-ion battery pack supplied with cleaner. Disconnect the supply before making or breaking the connections to the battery; Warning: Explosive gases. Prevent flames and sparks. Provide adequate ventilation during charging.

SAVE THESE INSTRUCTIONS

FOR CHARGING ON A 220-240 VOLT A.C. 50/60 HZ POWER SUPPLY ONLY.

This model is for household use only. This user guide can also be available on BISSELL official website.

Thanks for buying a BISSELL vacuum

We're glad you purchased a BISSELL vacuum. Everything we know about floor care went into the design and construction of this complete, high-tech home cleaning system.

Your BISSELL vacuum is well made, and we back it with a limited two-year guarantee. We also stand behind it with a knowledgeable, dedicated Consumer Care department, so, should you ever have a problem, you'll receive fast, considerate assistance.

My great-grandfather invented the floor sweeper in 1876. Today, BISSELL is a global leader in the design, manufacture, and service of high quality homecare products like your BISSELL vacuum.

Thanks again, from all of us at BISSELL.

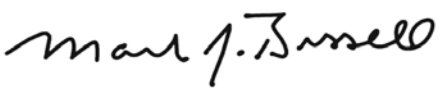

Mark J. Bissell
Chairman & CEO

Safety Instructions.....	2
Product View.....	4
Assembly.....	5
Operations.....	6-7
Maintenance & Care.....	8-9
Replacement Parts.....	10
Troubleshooting.....	11
Guarantee.....	12
Service.....	12



Product View



- 1 Handle
- 2 Extension Wand
- 3 Brush On/Off
- 4 Power Hi/Lo
- 5 Dirt Tank Release Button
- 6 Power Button
- 7 Pre-Motor Filter
- 8 Dirt Tank
- 9 Battery
- 10 Power Brush
- 11 Hose
- 12 2-in-1 Accessory
- 13 Hose Connector
- 14 Diverter Switch



Assembly

Your vacuum comes in five easy-to-assemble components:

Handle and Hose
Extension Tube
Battery
Base Unit
Foot
+
Charging Base

1. Insert the handle into the extension wand and click into place.
2. Slide the extension wand into the base unit.
3. Insert the hose end into the hose connector on the back of the base unit, making sure both tabs click into place and the notch is aligned.
4. The 2-in-1 accessory can be stored in the clip on the side of the unit.
5. Slide body of vacuum onto foot connector until you hear a click.
6. Push the battery into the housing until you feel it lock into place. Replace the battery housing cover.

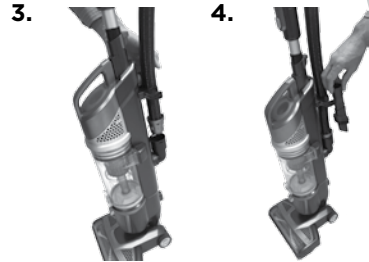
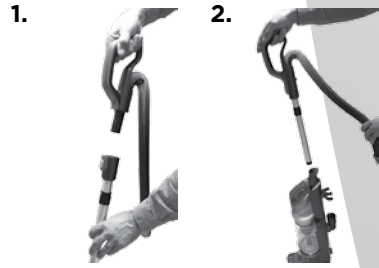

Operations

PowerBrush switch

1. Press the button with brush bar icon to run the PowerBrush.
2. The PowerBrush will not run when vacuum is locked in upright position
3. If debris is keeping the vacuum from operating, turn off power switch, remove debris, and then turn power switch on to resume vacuuming.

NOTE: Turn off the PowerBrush when vacuuming hard surfaces, such as hard wood or tiled floors, as well as when cleaning smaller rugs that may be caught by the rotating brush (see section Operate PowerGlide® Cordless for additional details).

Power Mode switch

1. Press the button with the +/- icon to switch between high and low power modes.
2. High power mode is useful for cleaning high traffic areas.

WARNING

Before using your vacuum, make sure that the dirt container is in locked position and that the filter is in place. DO NOT operate your vacuum without the filter.

1. brush

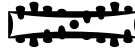

- 2.

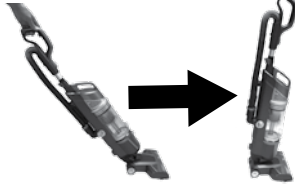

Tip

» Before cleaning under low furniture, check area first for objects that might harm the unit or block the vacuum hose.

Operations

Above floor cleaning

1. Twist diverter switch to horizontal position to direct suction to the vacuum hose.
2. Push down on the handle release button and pull the handle and extension tube out of the body.
3. The 2-in-1 accessory can be attached to the end of the extension tube.
4. The extension wand can be removed by pressing the release button and pulling it off.
5. The portable canister vacuum can be released by pressing the button on the back of the body and pulling away from the foot.
6. The canister vacuum can be carried around for easy cleaning of hard to reach areas.

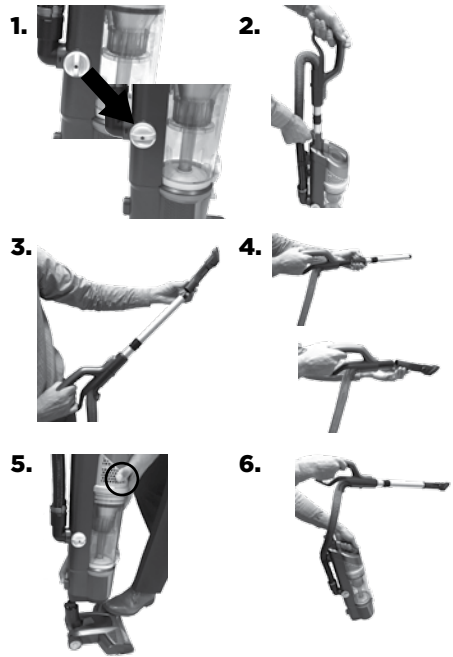

Charging the battery

1. Remove battery housing cover by pressing release button and pulling away.
2. Remove battery by pulling out of machine.
3. Place battery in charging base, ensuring it is plugged into the mains.
4. Charger light will turn red during charging and turn green when battery is full.
5. A full charge will take 2 hours.

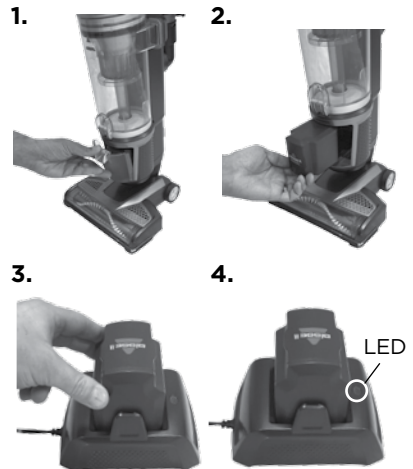

Maintenance & Care

Emptying the dirt container

1. Press the dirt tank release button and pull dirt tank away from body by the handle
2. Holding the Dirt Container over a trash bin, press the Release Button on back. Snap the bottom back into place.

WARNING

To reduce the risk of electric shock, turn power switch off and disconnect polarized plug from electrical outlet before performing maintenance or troubleshooting checks.

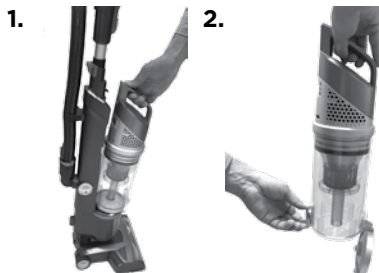

Cleaning the dirt container

1. Release dirt tank as above, then twist the top right to separate.
2. Remove filter by pulling up on the fabric tab, then pull out the cyclone system.
3. Empty dirt container in trash bin. It may be rinsed clean. Make sure it is completely dry before replacing.
4. To reassemble, line cyclone system up with dirt container using the semi circular and square tabs then slide in. Place filter on top with fabric tab out on the upper face, place lid last and twist left.



Cleaning the filter and cyclone

1. Release tank and remove lid as above, then remove Pre-motor Filter, clean with mild detergent and rinse.
2. Reinsert inside Dirt Container, once completely dried.
3. Remove cyclone system from dirt container as above.
4. The cyclone system can be broken down into three parts for easy cleaning. All pieces come apart with a simple twist. Rinse and dry with a paper towel.

WARNING

Do not operate cleaner with damp or wet filters or without filters in place.



Tip

» To maintain suction and good performance, it is recommended that you clean your filters every 4-5 uses and clean your cyclone system every other time you clean the filter.

Maintenance & Care

Replacing the Brush

1. Turn power switch off, turn over and use a coin or a flathead screwdriver to open the 2 locking screws on either side of the brush bar.
2. Remove both brush plates to access brush bar.
3. Grasp the roller from the bottom, dislodge by pulling, and then thread it through the belt.
4. Replace roller and reverse the order to reassemble.

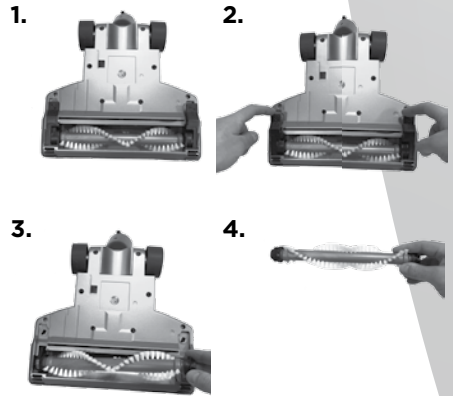







Disposal of batteries

If your vacuum is to be disposed of, the batteries should be removed and disposed of properly.

1. Keep Battery Pack together – DO NOT disassemble the battery pack. For specific disposal instructions of batteries, please follow local regulation.

Replacement Parts

These items are available for your BISSELL vacuum.
 Call 1-800-237-7691 or visit www.BISSELL.com

PART #	PART NAME		PART #	PART NAME	
160-6691	Battery		160-6697	Hose and Handle	
160-6187	Battery Charger		160-6698	Extension Wand	
160-7058	2-in-1 Accessory Tool		160-6359	Filter	
160-6689	Brush Roll				

Troubleshooting

Is your vacuum plugged in?
Are all hoses connected?

WARNING

To reduce the risk of electric shock, turn power switch off and disconnect polarized plug from electrical outlet before performing maintenance or troubleshooting checks.

Problem	Possible causes	Remedies
PowerBrush doesn't rotate	The PowerBrush power switch is turned off	Make sure PowerBrush switch is on
	Vacuum is locked in upright position	Recline vacuum and switch on the PowerBrush
Vacuum won't pick up dirt	There is a crack or hole in the Main Hose	If there is a crack or hole, order a new Main Hose from the BISSELL website
	The Power Brush bristles are worn	Replace the PowerBrush
	There is a clog in the vacuum	Remove debris and any other entanglements that may be restricting its rotation
	The Dirt Container is not seated correctly	Press the Empty Button to release the Dirt Container and reseal properly
	Filter is dirty	Remove and rinse pre-motor filter. Allow enough time for it to dry properly before reinserting
Hose won't pick up dirt	Diverter is switched to hose	Turn the diverter on the side of the unit to vacuum to pick up from the floor
	The Main Hose is not connected	Locate the Main Hose and reconnect by pushing the hose connection to secure the latch
Dirt is escaping from the vacuum	The Dirt Container is full	Empty the Dirt Container
	Filters are missing	Check to see if the pre-motor filter is in place
	The Dirt Container is not seated properly	Press the Empty Button and remove the Dirt Container. Insert the bottom first and pivot the Dirt Container towards the vacuum. Listen for a "click" sound, indicating that it snapped into place

Please do not return this product to the store.

Consumer Guarantee

This Guarantee only applies outside of the USA and Canada. It is provided by BISSELL International Trading Company BV ("BISSELL").

This Guarantee is provided by BISSELL. It gives you specific rights. It is offered as an additional benefit to your rights under law. You also have other rights under law which may vary from country to country. You can find out about your legal rights and remedies by contacting your local consumer advice service. Nothing in this Guarantee will replace or lessen any of your legal rights or remedies. If you need additional instruction regarding this Guarantee or have questions regarding what it may cover, please contact BISSELL Consumer Care or contact your local distributor.

This Guarantee is given to the original purchaser of the product from new and is not transferable. You must be able to evidence the date of purchase in order to claim under this Guarantee.

Limited Two-Year Guarantee

Subject to the *EXCEPTIONS AND EXCLUSIONS identified below, BISSELL will for two years from the date of purchase by the original purchaser repair or replace (with new or remanufactured components or products), at BISSELL's option, free of charge, any defective or malfunctioning part or product.

BISSELL recommends that the original packaging and evidence of the date of purchase be kept for the duration of the Guarantee period in case the need arises within the period to claim on the Guarantee. Keeping the original packaging will assist with any necessary re-packaging and transportation but is not a condition of the Guarantee.

If for your product is replaced by BISSELL under this Guarantee, the new item will benefit from the remainder of the term of this Guarantee (calculated from the date of the original purchase). The period of this Guarantee shall not be extended whether or not your product is repaired or replaced.

*EXCEPTIONS AND EXCLUSIONS FROM THE TERMS OF THE GUARANTEE

This Guarantee applies to products used for personal domestic use and not commercial or hire purposes. Consumable components such as filters, belts and mop pads, which must be replaced or serviced by the user from time to time, are not covered by this Guarantee.

This Guarantee does not apply to any defect arising from fair wear and tear. Damage or malfunction caused by the user or any third party whether as a result of accident, negligence, abuse, neglect, or any other use not in accordance with the User Guide is not covered by this Guarantee.

An unauthorised repair (or attempted repair) will void this Guarantee whether or not damage has been caused by that repair/attempt.

Removing or tampering with the Product Rating Label on the product or rendering it illegible will void this Guarantee.

SAVE AS SET OUT BELOW BISSELL AND ITS DISTRIBUTORS ARE NOT LIABLE FOR ANY LOSS OR DAMAGE THAT IS NOT FORESEEABLE OR FOR INCIDENTAL OR CONSEQUENTIAL DAMAGES OF ANY NATURE ASSOCIATED WITH THE USE OF THIS PRODUCT INCLUDING WITHOUT LIMITATION LOSS OF PROFIT, LOSS OF BUSINESS, BUSINESS INTERRUPTION, LOSS OF OPPORTUNITY, DISTRESS, INCONVENIENCE OR DISAPPOINTMENT. SAVE AS SET OUT BELOW BISSELL'S LIABILITY WILL NOT EXCEED THE PURCHASE PRICE OF THE PRODUCT.

BISSELL DOES NOT EXCLUDE OR LIMIT IN ANY WAY ITS LIABILITY FOR (A) DEATH OR PERSONAL INJURY CAUSED BY OUR NEGLIGENCE OR THE NEGLIGENCE OF OUR EMPLOYEES, AGENTS OR SUBCONTRACTORS; (B) FRAUD OR FRAUDULENT MISREPRESENTATION; (C) OR FOR ANY OTHER MATTER WHICH CANNOT BE EXCLUDED OR LIMITED UNDER LAW.

Consumer Care

If your BISSELL product should require service or to claim under our Limited Two-Year Guarantee, please visit:

Website or E-mail:

www.BISSELL.com

For UK inquiries:

Telephone: 0344 888 6644

Monday - Thursday 9am - 5pm

Friday 9am - 4pm

BISSELL Homecare (Overseas) Inc.
Ground Floor

226 Berwick Avenue

Slough, Berkshire, SL1 4QT

United Kingdom

Replacement parts and accessories are available for purchase. To purchase visit www.BISSELL.com

Visit the BISSELL website: www.BISSELL.com

When contacting BISSELL, have model number of cleaner available.

Please record your Model Number: _____ Please record your Purchase Date: _____

NOTE: Please keep your original sales receipt. It provides proof of the date of purchase in the event of a Guarantee claim. See Guarantee for details.



©2015 BISSELL Homecare, Inc
Grand Rapids, Michigan
All rights reserved. Printed in China
Part Number 160-6184 Rev 07/15
Visit our website at: www.BISSELL.com