

BUSH Dual Fuel Double Oven

Installation & User Instructions - Please keep for future reference

Cat no	Model
2443940	BUSH BDFD60B BLACK
2455110	BUSH BDFD60W WHITE
3653959	BUSH BDFD60S SILVER



Cooker serial number *place sticker here*

Important – Please read these instructions fully before installing or using

These instructions contain important information which will help you get the best from your appliance and ensure safe and correct installation, use and maintenance.

If you need help or have damaged or missing parts, call **Argos Product Support 01759 487838**

Contents

Safety Information	2-3
Parts	4
Installation	5-8
Positioning	6
Fixing to the wall	7
Electrical connection	9
User Instructions	9-12
Using the hob	9
Cookware selection	10
Using the main oven	11
Minute Minder and Clock	11
Using the top oven	12
Care and Maintenance	13
Troubleshooting	14
Technical Specifications	15
Disposal information	15
A Guide to Wall Mounting & Fixings	16
Guarantee	17





Important – Please read these instructions fully before installation

INSTALLATION WARNINGS

IMPORTANT: This product **MUST** be installed by a qualified Gas Safe registered installer in accordance with local regulations. Particular attention should be given to the ventilation requirements.

IMPORTANT: Prior to Installation ensure that the local supply conditions (gas type and pressure, electricity voltage and frequency) are compatible with the requirements of your cooker

IMPORTANT: Carefully unpack and examine the appliance for any damage. If you think there is a defect, do not use the appliance and contact Argos Product Support on **01759 487838**. Packaging materials should be collected together and disposed of immediately as they may be harmful to children.

IMPORTANT: Keep the electrical cable (not supplied) of your cooker away from the hot areas of your cooker; do not let the cable touch the appliance. Keep the cable away from sharp edges and heated surfaces.

IMPORTANT: Ensure that the electric supply cable is not trapped or damaged during installation.

IMPORTANT: In the event that the cable connecting your cooker becomes damaged, it must be replaced by a suitably qualified person. **This cable must not be replaced by an unauthorised person.**

IMPORTANT: Protect your cooker against atmospheric effects. Do not expose your cooker to effects such as sun, rain, snow etc.

IMPORTANT: The materials surrounding the appliance (cabinets) must be able to withstand a minimum temperature of 100°C

IMPORTANT: When using your oven for the first time your cooker may give off an unusual odour from the heating elements and insulation materials. This is normal for new cookers. To eliminate this odour run the oven at 250 degrees for 40-60 mins with the oven empty.

DURING USAGE

IMPORTANT: Children and persons with reduced physical, sensory or mental capabilities or lack of experience and knowledge should not be allowed to use the cooker unless supervised and warned of the hazards involved

WARNING: The appliance and its accessible parts become hot during use. Care should be taken to avoid touching hot parts.

WARNING: Cooking on a hob with fat or oil can be dangerous and should not be left unattended.

WARNING: NEVER try to extinguish a cooking fire with water. Instead switch off the appliance and cover flame e.g. with a lid or a fire blanket.

CAUTION: Cookers may topple forward if a child climbs onto the cooker door. Children should be supervised in the kitchen at all times and this cooker must be secured to the wall using the fixing points provided to prevent accidents.

CAUTION: Do not allow children in the kitchen when cooking or while cooker parts may still be hot. Many parts of the cooker will become hot and present a considerable hazard to children.

CAUTION: When the oven is hot never touch the oven glass by hand or with tools.

CAUTION: Before starting to use your appliance, ensure curtains, paper or flammable items are kept away from your appliance. Do not keep flammable materials inside of or around your cooker.

CAUTION: Take care when closing the oven door that there is nothing obstructing it from closing as this may break the glass door.

IMPORTANT: When using the grill the oven door must be kept closed.

IMPORTANT: Position pans over the centre of the burners and turn handles to a safe position where they can not be knocked or grabbed.



Important – Please read these instructions fully before installation

IMPORTANT: Make sure the cooker control knobs are all in the off position when not in use

IMPORTANT: If you do not intend to use your cooker for a long period of time turn off the gas and electric supply to the cooker

CAUTION: Using gas cooking appliances results in the production of heat, moisture and the products of combustion. Ensure that the room where your cooker is installed is well ventilated particularly while the cooker is in use. Keep natural ventilation holes open or install a mechanical ventilation device (extractor hood) Prolonged intensive use of your cooker may call for additional ventilation (by opening a window) or by increasing the level of mechanical ventilation where present.

GENERAL SAFETY WARNINGS

IMPORTANT: This appliance has been designed for non-professional, domestic use only. Do not use this cooker for commercial use or any other application e.g. room heating

WARNING: Danger of fire: do not store flammable items on or near the cooking surfaces or inside the oven.

IMPORTANT: Do not try to lift or move this cooker by pulling on the door handle

WARNING: Ensure that the appliance is switched off before replacing the lamp to avoid the possibility of electric shock.

IMPORTANT: Your appliance is produced in accordance with all applicable local and international standards and regulations.

IMPORTANT: Maintenance and repair work must only be performed by authorized service technicians.

Installation and repair work that is carried out by unauthorised technicians is dangerous and could invalidate your guarantee

IMPORTANT: When the door of the oven is open, do not hang or lean anything on it. You may unbalance your appliance or damage the door or door hinges.

IMPORTANT: Do not hang towels, dishcloths or clothes from the cooker or its handles.

CLEANING AND MAINTENANCE

IMPORTANT: Always turn the appliance off before operations such as cleaning or maintenance. You can do this by switching the cooker off using cooker isolation switch.

IMPORTANT: Do not remove the control knobs to clean the control panel.

TO MAINTAIN THE EFFICIENCY AND SAFETY OF YOUR APPLIANCE,
WE RECOMMEND YOU ALWAYS USE
OUR AUTHORIZED SERVICE AGENTS AND
ORIGINAL SPARE PARTS.

FOR ASSISTANCE CALL
ARGOS PRODUCT SUPPORT
01759 487838.

Parts

If you have damaged or missing parts,
call **Argos Product Support 01759 487838**

Please familiarise yourself with the parts and accessories listed below

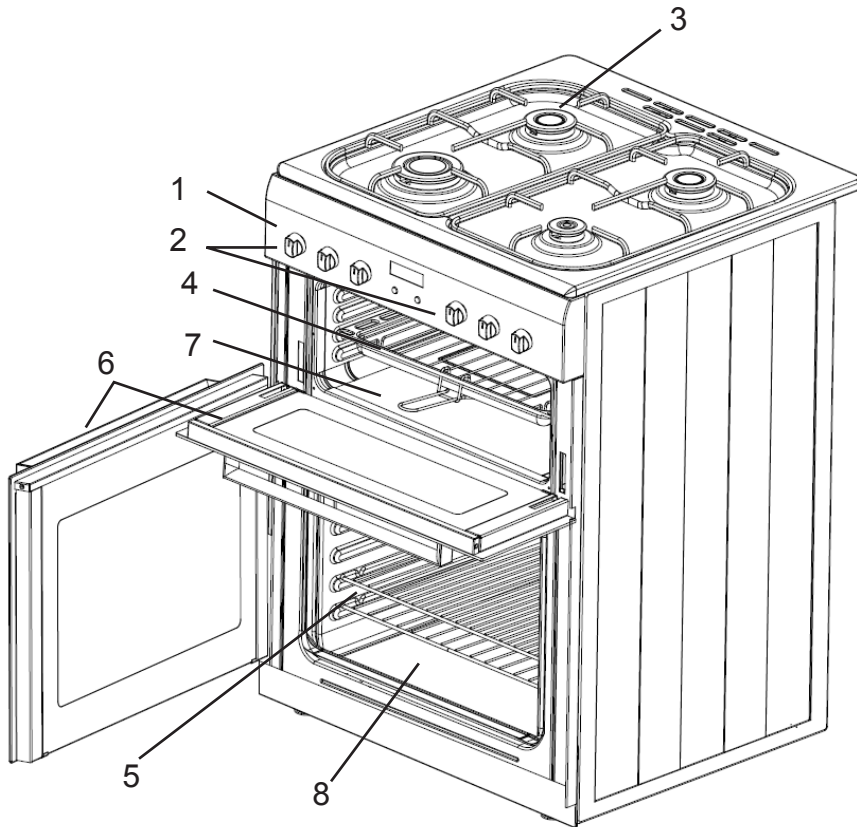

- 1 - Control panel
- 2 - Oven controls + heat indicators
- 3 - Gas hobs X 4
- 4 - Grill pan with removable handle
- 5 - Wire shelves X 2
- 6 - Oven doors
- 7 - Top oven
- 8 - Main oven

Accessories

Grill pan and handle set



2 wire shelves

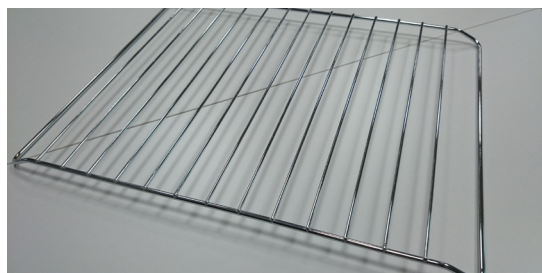

Installation gas

**THIS COOKER MUST BE INSTALLED
ACCORDING TO BS 6172: 2010 BY
A SUITABLY QUALIFIED GAS SAFE
REGISTERED INSTALLER**

This modern cooker was manufactured with parts and materials of the highest quality and was designed to meet your cooking needs. You should read this manual so that you are able to use the cooker correctly and to avoid any potential problems with using the cooker. The following information outlines the required rules for correct installation and service of your cooker. This is particularly important for the technician who will install the appliance.

**CONTACT AN AUTHORISED SERVICE
AGENT FOR INSTALLATION OF YOUR OVEN!**

VENTILATION REQUIREMENTS

For rooms with a volume of less than 5 m³ - permanent ventilation of 100 cm² is required see figure 1 and 2 for an example.

For rooms with a volume of between 5 m³ and 10m³ a permanent ventilation of 50 cm² will be required unless the room has a door which opens directly to the outside, in which case no permanent ventilation is required.

For rooms with a volume greater than 10 m³ - no permanent ventilation is required.

Attention: Regardless of room size, all rooms containing the appliance must have direct access to the outside air via an openable window or equivalent. The room containing the cooker should have an air supply in accordance with BS 5440: Part 2.

Environment where your appliance will be installed

Your cooker must be set up and used in a place where it will always have ventilation

While operating, this appliance needs 2m³/h air per kw input.

There must be enough natural ventilation to provide the gas to be used in the environment. The average air flow must directly come in through ventilation from the outside.

Emptying of the Burned Gases from Environment

For cooking appliances that operate with gas, burned gas wastes are exhausted directly to the outside or through cooker hoods that are connected to a chimney that opens directly to the outside. If it is not possible to install a cooker hood, it is required to set an electric fan on the window or wall that has access to fresh air. This electric fan must have the capacity to change the volume of air in the kitchen environment 4-5 times per hour

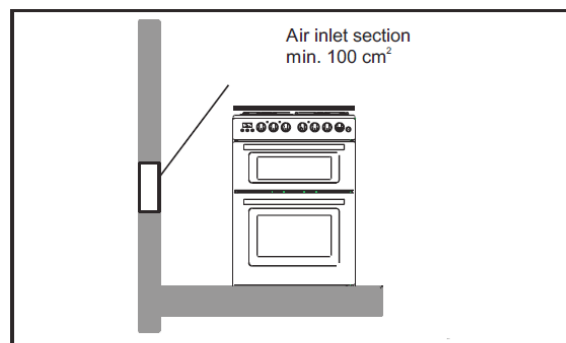

Figure 1

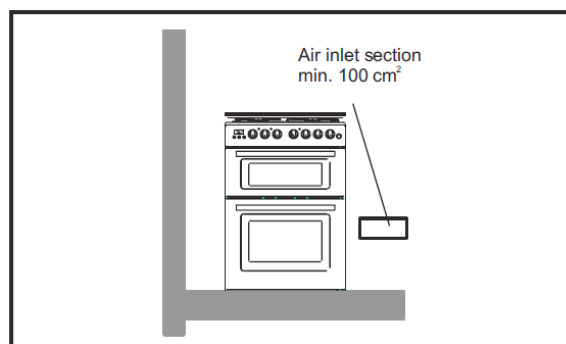

Figure 2

Installation gas

Installation of cooker

IMPORTANT - All Gas installations must be carried out by a suitably qualified person. For information on choosing a gas installer contact the 'Gas Safe Register'.

The appliance can be placed close to other furniture on condition that the furniture's height does not exceed the height of the cooker panel. Make sure that there are no combustible or flammable materials, such as curtains, in the vicinity of the installation.

There must be at least 2cm of free space between the back wall and the rear of the appliance to allow for ventilation and air circulation.

Positioning

The furniture close to the cooker must be manufactured resistant to temperatures up to 100°C

If the kitchen furniture are higher than the hob plate of the cooker, it must be at least 10cm away from the cooker's side.

Surrounding furniture, cabinets and extractor fans should be positioned in accordance with the diagram shown in figure 3. If fitted, the extractor fan must be at least 65cm above the hob.

If no fan is fitted the minimum distance between the hob and any cabinet or other structure must be 70cm.

Adjustment of feet

The height and level of the appliance can be adjusted by rotating the feet located underneath the appliance at each corner. Rotate in a clockwise direction to decrease the height and anti clockwise to increase the height.

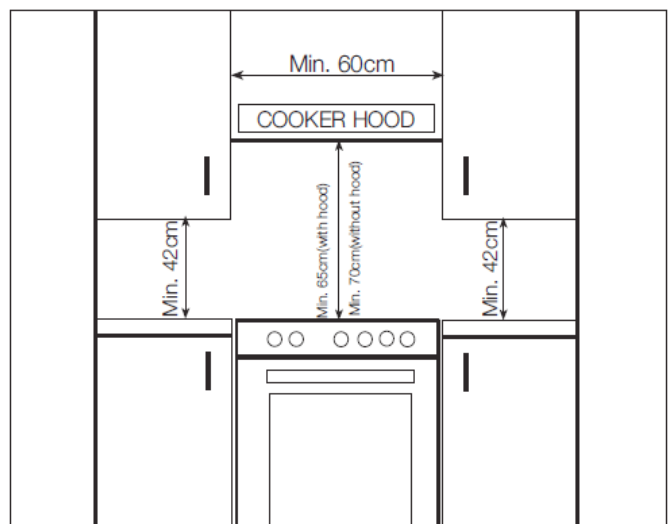

Figure 3

Installation gas

Gas Connection

This appliance must be installed by a suitably qualified gas safe registered gas installer to standard BS 6172: 2010

Fixing to the wall

Before using the appliance fix it securely to the wall using the chains on the back of the cooker. This will prevent the cooker from toppling forward if excess weight is placed on the oven door. Since the chains must be attached to wall fixings suitable for your wall type, the wall fixings are not supplied with the cooker (Figure 4).

Please refer to the 'Guide to Wall Mounting and Fixings' on page 16.

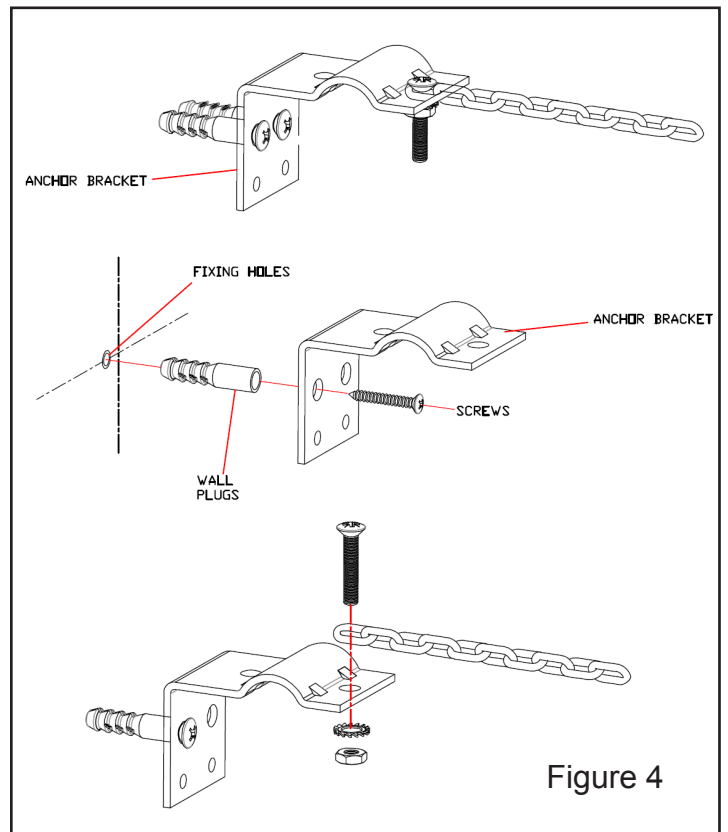

Installation

Argos Product Support 01759 487838

Electrical connection



IMPORTANT: Electrical connections must be carried out by a suitably qualified person and in accordance with all relevant local building and installation regulations.

1. See the rating label at the rear of the product for the appliance's load rating.
2. The cooker must be connected to a dedicated circuit suitably rated for the load of the appliance (see rating label at rear of appliance) as shown in the wiring diagrams below. It must be connected via a suitably rated cable to a double pole isolator/cooker switch also suitably rated for the appliance.

3. The electrical cable should not touch the hot parts of the appliance.

The electrical cable (not supplied) should not be routed through any area that may be affected by heat from the oven, especially the area directly behind the oven.

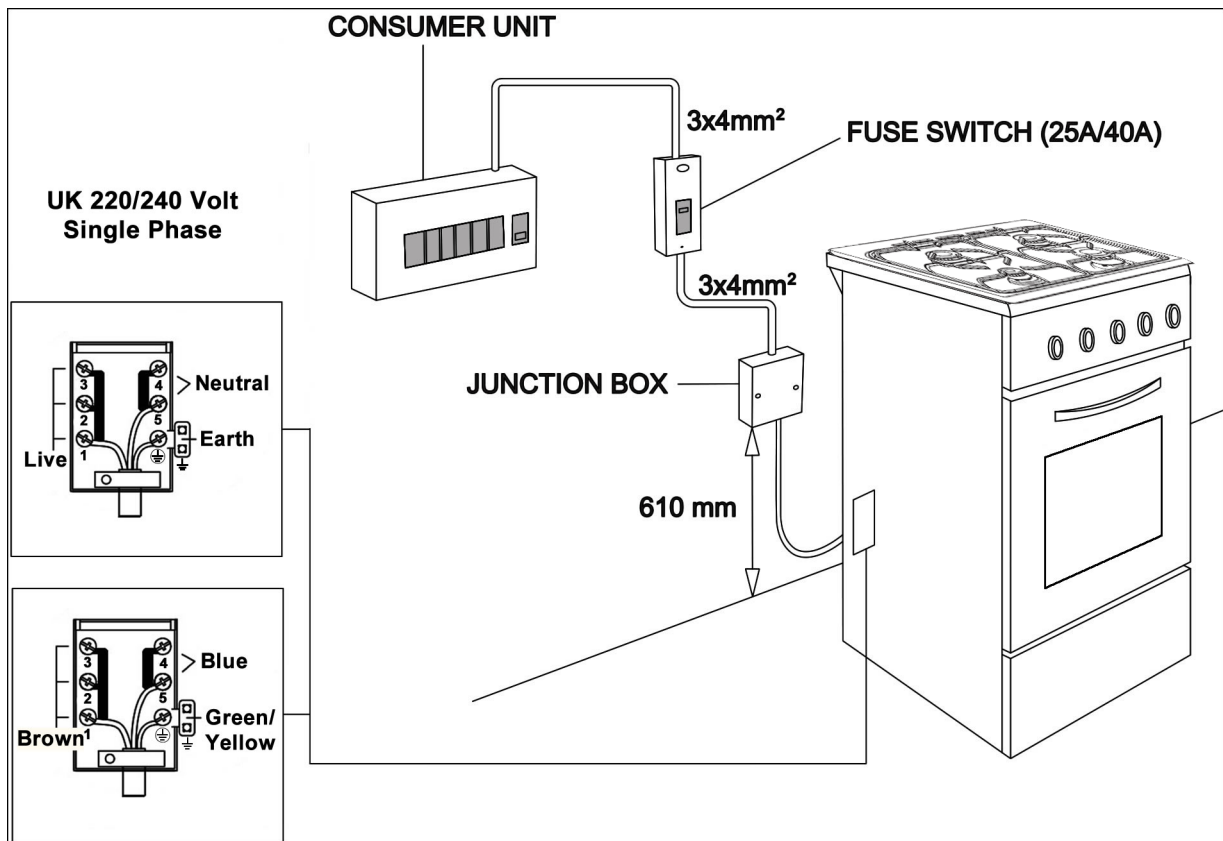

Using the Hob

Ignition Button

Press the knob of the burner you want to operate and turn the knob in the counter-clockwise direction so that the knob is in max. position and with your other hand, press the ignition button at the same time. Press the ignition button immediately.

Manual Ignition of the Gas Burners

In the case of electricity failure resulting in loss of electronic ignition follow this procedure.

To ignite one of the burners, press and turn its knob counter-clockwise so that the knob is in max. position, ignite with a match, taper or another manual aid to its upper circumference. Move the ignition source away as soon as you see a stable flame.

Flame failure device:

This cooker is equipped with a flame failure device

In order for these to work correctly and to prevent the flame going out when you first ignite your burners, keep the knob pressed and hold for 10 seconds after the burner has ignited

Hob Burner Control

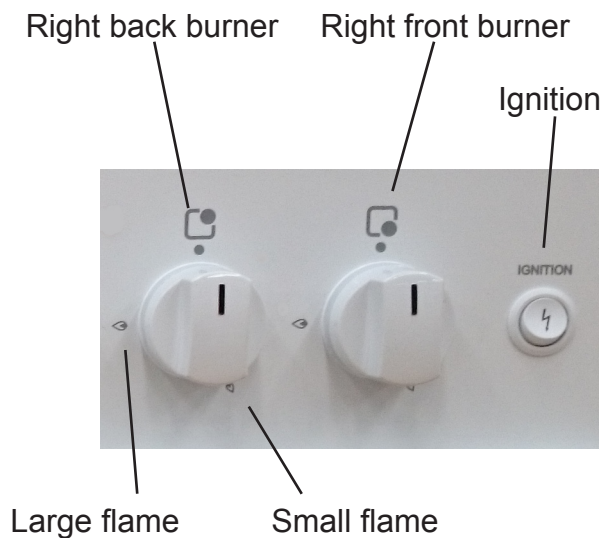

Control of the hob burners

The knob has 3 positions: Off (0), max (big flame symbol) and min (small flame symbol). After you ignite the burner in max. position you can adjust the flame length between max. and min. positions.

Do not operate the burners when the knob position is between max. and off positions. After the ignition, check the flames visually. If you see yellow tips, lifted or unstable flames; turn the gas flow off, and check the assembly of burner caps and crowns. Also, make sure that no liquid has spilled into the burner caps.

If the burner flames go out accidentally, turn the burners off, ventilate the kitchen with fresh air, and do not attempt re-ignition for 90 sec.

Using the Hob

When turning the hob off, turn the knob in the clockwise direction so that the knob shows “0” position or the marker on the knob points upwards.

Your hob has burners of different diameters. The most economic way of using gas is to choose the correct size gas burners for your cooking pan size and to bring the flame to the minimum position once the boiling point is reached. It is recommended to always cover your cooking pan.

Cookware Selection

In order to obtain maximum performance from the main burners, use pots with the following flat bottom diameters. Using smaller pots than the minimum dimensions stated below will cause energy loss.

Rapid Burner: 22-26cm
Medium Burner: 14-22cm
Auxiliary Burner: 12-18cm

Make sure that the tips of the flames do not spread out of the outer circumference of the pan, as this may also harm the accessories around the pan (handles etc.) When the burners are not in use for prolonged periods, always turn the main gas control valve off.

WARNING:

Use only flat bottomed pans and with a sufficiently thick base.

Ensure that the base of the pan is dry before placing it on the burners.

The temperature of accessible parts may be high when the appliance is operating. So it is important to keep children and animals out of the reach of the burners during and after cooking (until the cooker has cooled down).

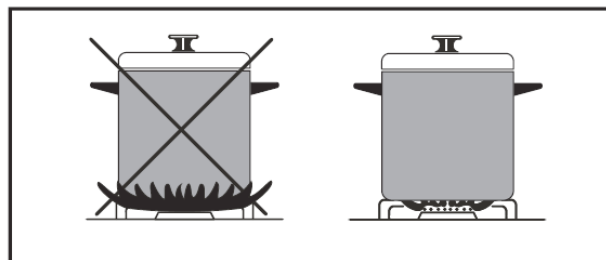

After use the hob remains very hot for a prolonged period of time, do not touch it and do not place any object on top of the hob.

Never place cutlery or lids on the hob as they will get hot and could cause serious burns.

SAFETY ADVICE IN THE CASE OF A COOKING PAN FIRE

1. Turn off the burner.
2. Cover the pan with a fire blanket or damp cloth. This will smother the flames and extinguish the fire.
3. Leave the pan to cool for at least an hour before attempting to move it. Injuries are often caused by picking up a hot pan and rushing outside with it.

NEVER USE A FIRE EXTINGUISHER TO PUT OUT A PAN FIRE

as the force of the extinguisher could tip the pan over.

Never use water to extinguish oil or fat pan fires.

Using the main oven

Using the Main Fan Oven

Turn the Main Oven knob clockwise and align the marker on the control knob with the required temperature (°C)

The indicator light on the control panel will go out and the thermostat will turn the element off when the selected temperature has been reached inside the oven. These will come back on once the thermostat falls below the set value.

Fan only defrost

The fan can be used without heat to defrost food (DEFROST)

IMPORTANT! Before using this method of defrosting refer to the food packaging defrosting information

Always turn the control knob to off (●) when cooking has finished.

Please note: The appliance incorporates a safety thermostat which cuts the electric supply to the oven if the temperature becomes excessive.

When using your oven for the first time your cooker may give off an unusual odour from the heating elements. This is normal for new cookers. To eliminate this odour run the oven at 250 degrees for 40-60 mins with the oven empty.

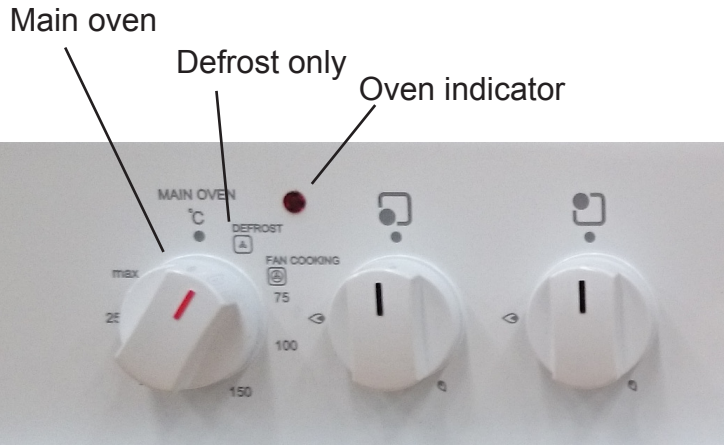

MINUTE MINDER AND CLOCK

SETTING THE CLOCK (24-HR)

To set the time of day press the + and - buttons at the same time. The display will show 12:00. Press the + or - button until the correct time is shown in the display. Release the button.

SETTING THE MINUTE MINDER ALARM

Press the + button.

Press the + button again until the required cooking period is shown in the display.

After 5 seconds countdown will start.

At the end of the cooking period the alarm will sound.

Press the - button to stop the alarm.

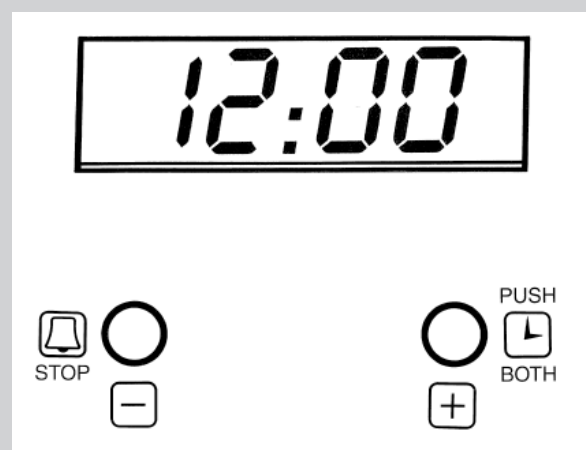

Using the top oven

Using the Top Oven

Turn the control knob (TOP OVEN) clockwise and align the marker on the knob with the required temperature.

The indicator light on the control panel will go out when the selected temperature has been reached inside the oven.

Always turn the control knob to off (●) when cooking has finished.

Please note: The appliance incorporates a safety thermostat which cuts the electric supply to the oven if the temperature becomes excessive.

For using the Bottom element Top element Grill

Turn the control knob counter clockwise and align the marker with the desired function.

These elements are set to operate at their maximum output (fixed)

The TOP OVEN door **must be closed** for all operations

Always use the handle when handling the grill pan

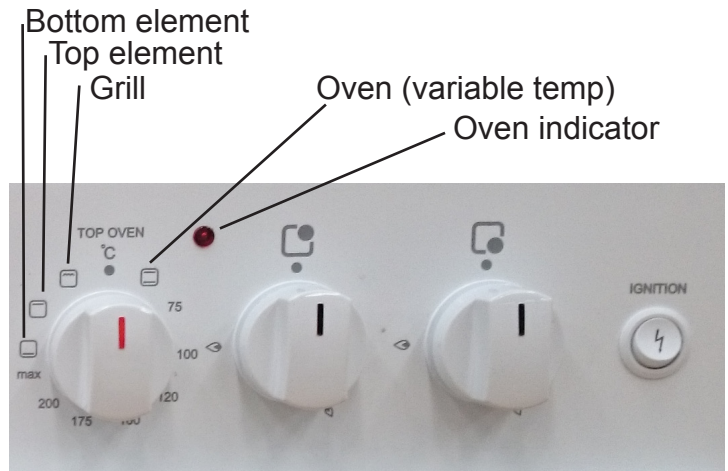

Cleaning

WARNING! Isolate the power supply to the cooker and make sure that the oven is cool.

Do not clean using caustic creams, abrasive cleaning powders, thick wire wool or hard tools. Enamelled parts of the oven can be damaged if excess cleaning liquids are not immediately removed.

After cleaning the interior parts of the oven with a soapy cloth, rinse it and then dry thoroughly with a soft cloth.

Clean the glass surfaces with special glass cleaning agents.

Never use flammable agents like acid, thinner or petrol when cleaning your oven.

Do not clean your oven with a steam cleaner.

Do not wash any part of your oven in a dishwasher.

Removal of inner glass door for cleaning

Remove the inner glass by sliding the glass out towards you.

Change of Oven Lamp

Turn the oven off from the electric supply and make sure that the oven is cool.

Remove the bulb after removing the cover in front of lamp. Replace the old bulb with a new bulb resistant to 300°C (230 V, 25 Watt, Type E14).

Replace the lamp protective glass.

Your oven is now ready for use.

Burner Caps:

Periodically, the enamelled pan support, enamelled covers and burner heads must be washed with warm soapy water, rinsed and dried. After drying them thoroughly, place them back in their original positions on the burners

Enamelled Parts:

In order to keep them as new, it is necessary to clean them frequently with mild warm soapy water and then dry with a cloth. Do not wash them while hot and never use abrasive powders or abrasive cleaning materials. Do not leave anything spilled onto enamelled parts for long periods of time.

Stainless Steel:

Stainless steel parts must be cleaned frequently with mildly warm soapy water and a soft sponge and then dried with a soft cloth. Do not use abrasive powders or abrasive cleaning materials. Do not leave anything spilled onto stainless steel parts for long periods of time.

Troubleshooting

Argos Product Support 01759 487838

If your cooker does not appear to function correctly

1. If no electrical functions appear to work, check the cooker isolation switch has not been turned off also check the fuse in the switch and the circuit breaker in your consumer unit

2. After replacing the fuse or resetting the circuit breaker turn on individual parts of your cooker one at a time to check function

3. **DO NOT** attempt to repair this cooker yourself. Call Argos Product Support or consult a qualified person

Problem	Possible Cause	Solution
Only parts of the cooker work it may be that the ovens or the grill, do not work	Links may be missing in the rear connector box	Refer to the Quick Start Guide to check the correct placement of the links This must be done by a qualified competent person
Nothing works (completely dead)	Power is turned off at the isolation switch or the consumer unit Poor electrical connection	Ensure isolation switch is on Check consumer unit has not tripped out Have the connections checked by a qualified electrician
The hob burners do not operate correctly	Check if the burner parts are correctly assembled (especially after cleaning).	The gas supply pressure may be too low/high. For appliances working with bottled LPG, the LPG cylinder may be depleted.
Oven not heating up	Oven temperature not set correctly Door is not properly closed	Ensure that the correct temperature has been selected and the door is properly closed

Technical Specifications

Argos Product Support 01759 487838

Models	BUSH BDFD60B BLACK BUSH BDFD60W WHITE BUSH BDFD60S SILVER
Power supply	220-240V~50 Hz
Maximum power	4000W
Size (H x W x D)	900 x 600 x 600
Net Weight	47.36 kg
Top oven volume	30 lt
Main oven volume	61 lt
Energy rating	A

We apologise for any inconvenience caused by minor inconsistencies within these instructions that may occur due to product improvements and development

All images and drawing are for illustration purposes only.



This appliance/fitting is marked according to the European directive 2002/96/EC on Waste Electrical and Electronic Equipment (WEEE). By ensuring this product is disposed of correctly, you will help prevent potential negative consequences for the environment and human health, which could otherwise be caused by inappropriate waste handling of this product.

The symbol on the product, or on the documents accompanying the product, the **crossed out wheeled bin** symbol, indicates that this appliance/fitting may not be treated as household waste. Instead it shall be handed over to the applicable collection point for the recycling of electrical and electronic equipment. Disposal must be carried out in accordance with local environmental regulations for waste disposal. For more detailed information about treatment, recovery and recycling of this product, please contact your local authority, your household waste disposal service or the retailer where you purchased the product.

Wall Fixing Guide

Argos Product Support 01759 487838

Important note:

If plastic wall plugs are supplied with your product:



- these are only suitable for use in masonry walls.

If you are in any doubt about the correct wall plugs for your wall, seek professional advice.

Failure of the product due to using incorrect fixings is the responsibility of the installer.



Important: When drilling into walls always check that there are no hidden wires or pipes etc.

Make sure that the screws and wall plugs being used are suitable for supporting your unit. Consult a qualified tradesperson if you are unsure.

Hints:

- 1: General rule:  Always use a larger screw and wall plug if you are not sure.
- 2: Ensure you use the recommended drill bit to match the wall plug and hole size.
- 3: Ensure you drill the hole horizontally, do not force the drill or enlarge the hole.
- 4: Take extra care when drilling high walls, ceilings and ceramic tiles. Ensure wall plugs are inserted beyond the thickness of the ceramic tiles to avoid the tiles splitting or cracking.
- 5: Ensure wall plugs are well fitted and are a tight fit in the drilled hole.

Types of walls

You can use one of the following types of wall plug if your walls are made of brick, breeze block, concrete, stone or wood.

No.1 "General Purpose" wall plug

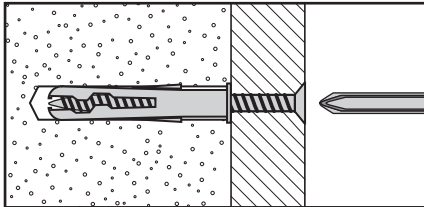

Generally aerated blocks should not be used to support heavy loads, use a specialist fitting in this case. For light loads, general purpose wall plugs can be used.

No.2 "Plasterboard" wall plug

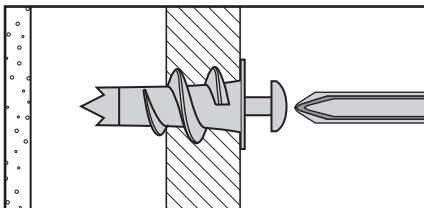

For use when attaching light loads on to plasterboard partitions.

No.3 "Cavity Fixing" wall plug

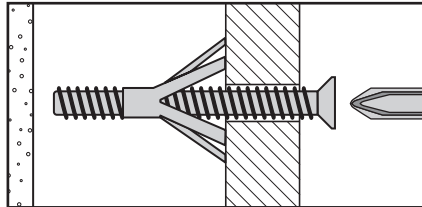

For use with plasterboard partitions or hollow wooden doors.

No.4 "Cavity Fixing-Heavy Duty" wall plug

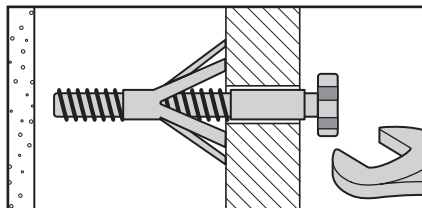

For use when fitting or supporting heavy loads such as shelving, wall cabinets and coat racks.

No.5 "Hammer Fixing" wall plug

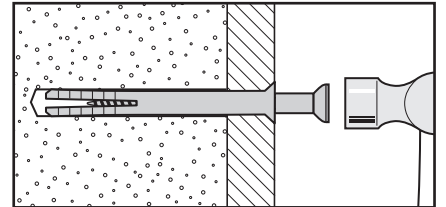

For use with walls stuck with plasterboard. The hammer fixing allows it to be fixed to the wall rather than the plasterboard. Always check the fixing is secure to the retaining wall.

No.6 "Shield Anchor" wall plug Heavy loads

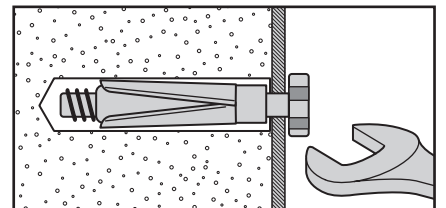

For use with heavier loads such as TV & HiFi speakers and satellite dishes etc.



Care & Maintenance

Safety: Always check the fitting and location to ensure your safety in and around the home.

Fitting: From time to time check the fitting to ensure the wall plugs or screws do not become loose.



Product Guarantee

This product is guaranteed against manufacturing defects for a period of



This product is guaranteed for 12 months from the date of original purchase. Any defect that arises during this period due to faulty materials or workmanship will either be repaired free of charge or replaced.

The guarantee is subject to the following provisions:

- The guarantee does not cover accidental damage, misuse, cabinet parts, knobs or consumable items.
- The product must be correctly installed and operated in accordance with the instructions contained in this manual.
- It must be used solely for domestic purpose.
- The guarantee will be rendered invalidated if the product is re-sold or has been damaged by inexpert repair.
- Specifications are subject to change without notice.
- The manufacturer disclaims any liability for the incidental or consequential damages.
- The guarantee is in addition to, and does not diminish your statutory or legal rights.
- In the event of a problem with the product with in the guarantee period call :-
Argos Product Support 01759 487838.

Guarantor: Argos Ltd
489 - 499 Avebury Boulevard
Central Milton Keynes
MK9 2NW