

Newstead 4'6 and 5' Bed

Assembly Instructions – Please keep for future reference

333/6895

338/6783

359/4070

355/7983



Dimensions (4'6)

Length - 201cm
Width - 145cm
Height - 123cm

Dimensions (5')

Length - 211cm
Width - 160cm
Height - 123cm

Important – Please read these instructions fully before starting assembly

If you need help or have damaged or missing parts, call the Customer Helpline: 0345 6400 800



Safety and Care Advice

Important – Please read these instructions fully before starting assembly

- Check you have all the components and tools listed on pages 2 and 3.
- Remove all fittings from the plastic bags and separate them into their groups.
- Keep children and animals away from the work area, small parts could choke if swallowed.
- Parts of the assembly will be easier with 2 people.
- Make sure you have enough space to layout the parts before starting.
- Assemble the item as close to its final position (in the same room) as possible.
- Dispose of all packaging carefully and responsibly.
- Place the product on flat and steady surface during use.
- Assemble on a soft level surface to avoid damaging the unit or your floor.
- Keep these instructions for further use.
- To ensure an easier assembly, we strongly advise that all fittings are only finger tightened during initial assembly. Only upon completion of the assembly should all fixing points be fully tightened.

Care and maintenance

- Only clean using a damp cloth and mild detergent, do not use bleach or abrasive cleaners.
- From time to time check that there are no loose screws on this unit.
- This product should not be discarded with household waste. Take to your local authority waste disposal centre.

Components - Parts

If you have damaged or missing components, call the **Customer Helpline: 0345 6400 800**

Please check you have all the parts listed below

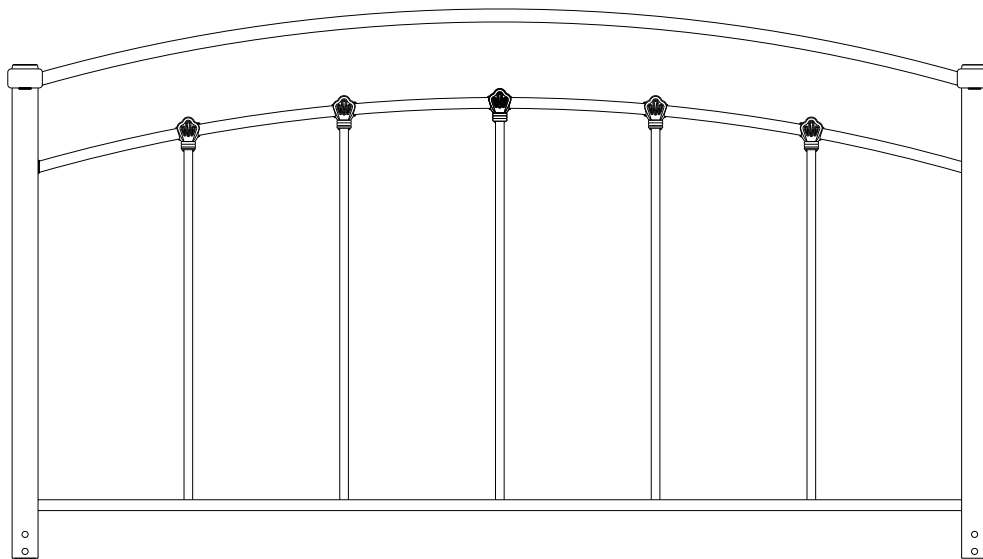

1 Headboard panel (144.6 x 80.7cm) (159.6 x 80.7cm)

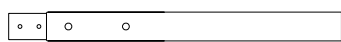

2 Headboard post x 2 (505 x Ø3.8cm)

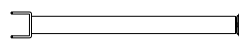

7 Support leg x 2 (33 x Ø2.5cm)

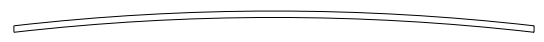

8 Bentwood slat x 32 (6.5x70.5cm) (6.5x78cm)

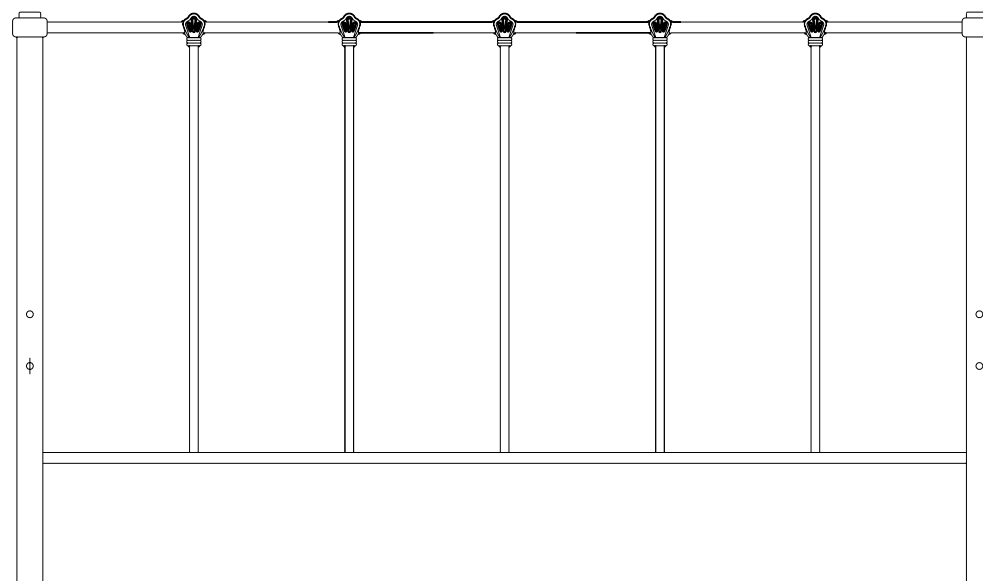

3 Footboard panel (144.6 x 84cm) (159.6 x 84cm)

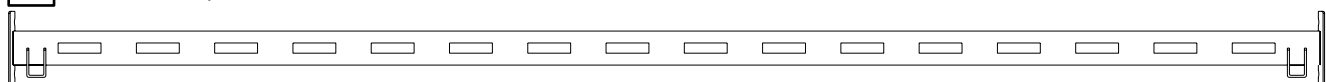

4 Side rail x 2 (193.7 x 10.8cm) (203.7 x 10.8cm)

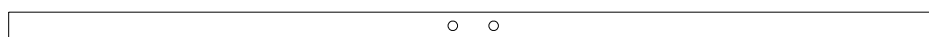

5 End support x 2 (136.5 x 4cm) (151.7 x 4cm)

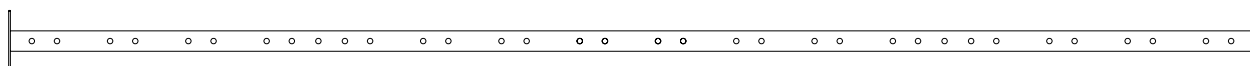

6 Central support (183 x 9cm) (187.8 x 9cm)







9 Finial x 4 (Ø5.2cm)

Components - Fittings

If you have damaged or missing components, call the **Customer Helpline: 0345 6400 800**

Please check you have all the fittings listed below

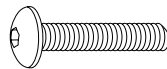
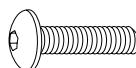
Note: The quantities below are the correct amount to complete the assembly. In some cases more fittings may be supplied than are required.

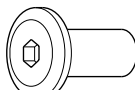
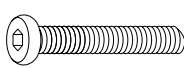
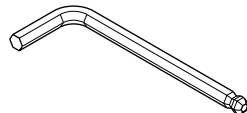
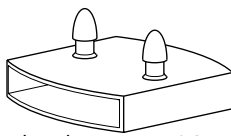
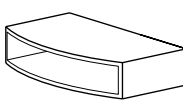
<p>A</p>  <p>15mm Allen screw x 12</p>	<p>B</p>  <p>Plain washer x 22</p>	<p>C</p>  <p>32mm Allen screw x 4</p>
<p>D</p>  <p>25mm Allen screw x 4</p>	<p>E</p>  <p>Rubber washer x 8</p>	<p>F</p>  <p>Nut x 4</p>
<p>G</p>  <p>45mm Allen screw x 2</p>	<p>H</p>  <p>Allen key x 2</p>	<p>J</p>  <p>Central plastic cap x 16</p>
<p>K</p>  <p>Plastic cap x 32</p>		

Tools required

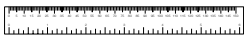

Ruler/tape
measure

Ruler - Use this ruler to help correctly identify the screws

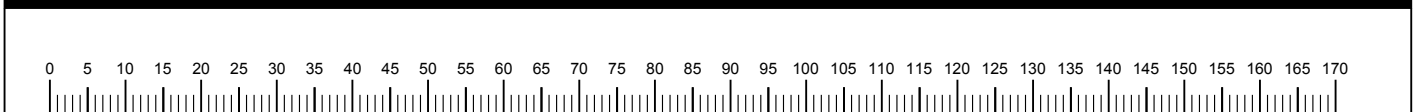

Assembly Instructions

Step 1

Assembling posts

Place headboard panel **1** face down onto a clean flat surface.

Note: Fixing holes for posts should be facing up.

Secure headboard posts **2** to headboard panel **1** using fixings **A** and **B**.

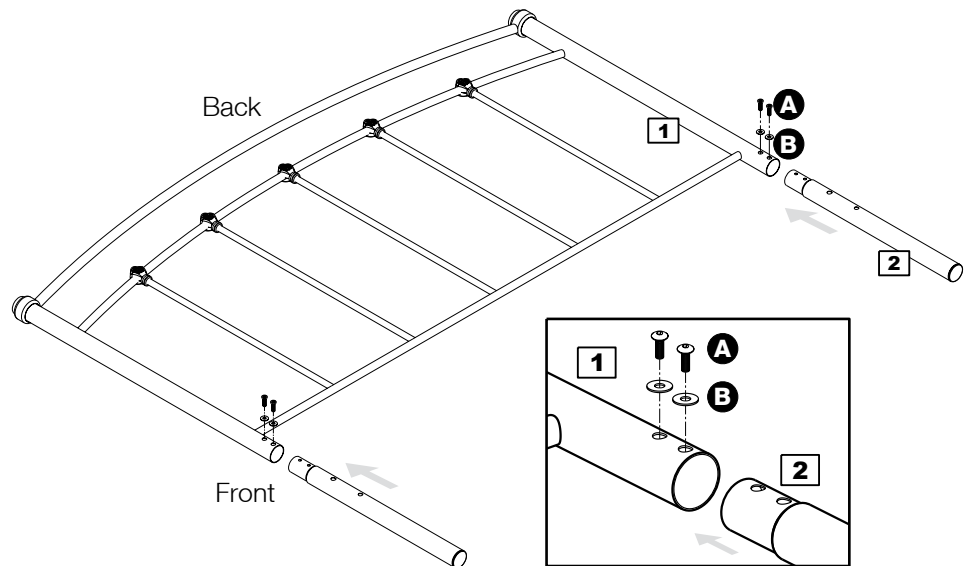

Step 2

Assembling side rails

a: With help, assemble side rails **4** to the headboard using fixings **B**, **D**, **E** and **F**.

Note: Ensure the metal brackets are at the bottom as shown.

b: Assemble footboard **3** to the side rails using fixings **B**, **C** and **E**.

c: Screw finials **9** into the headboard and footboard corner posts.

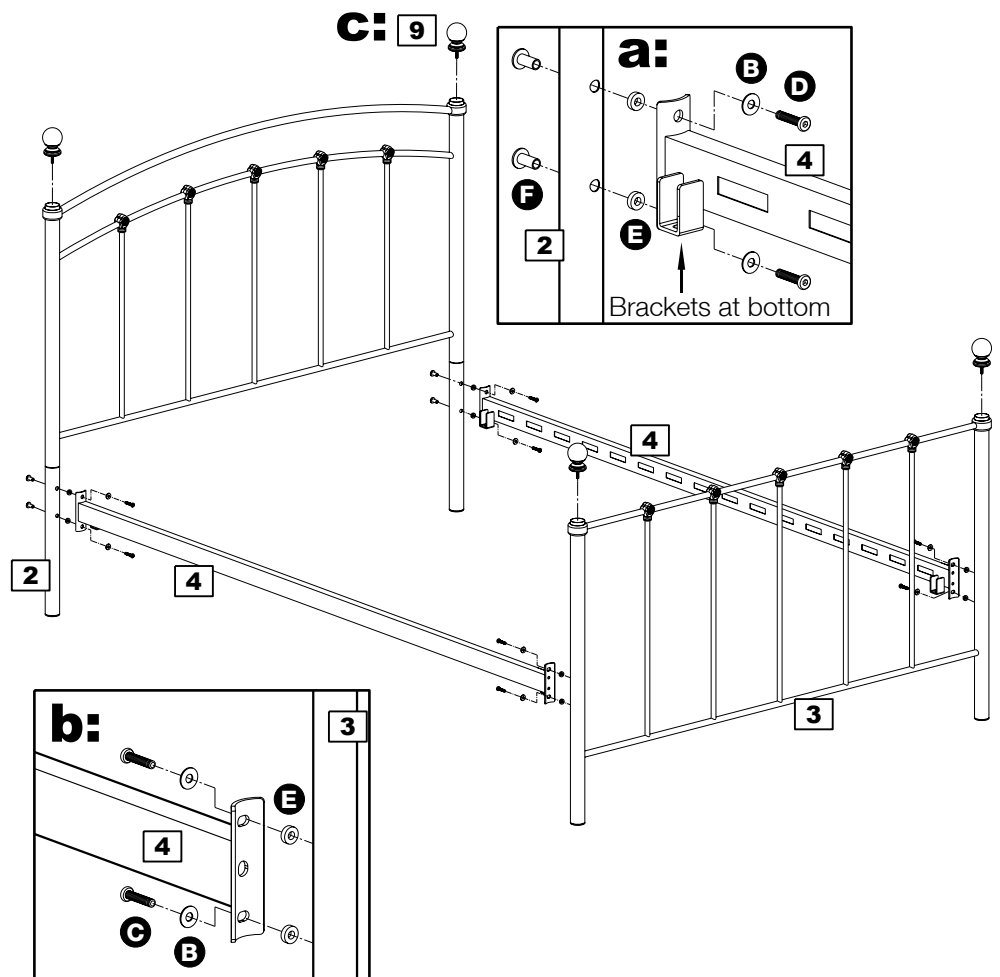

Assembly Instructions

Step 3

Securing end supports

Locate end supports **5** into the metal brackets on the inside of side rails **4**.

Note: Ensure the fixing holes are on the inside as shown.

Secure using fixings **A** and **B**.

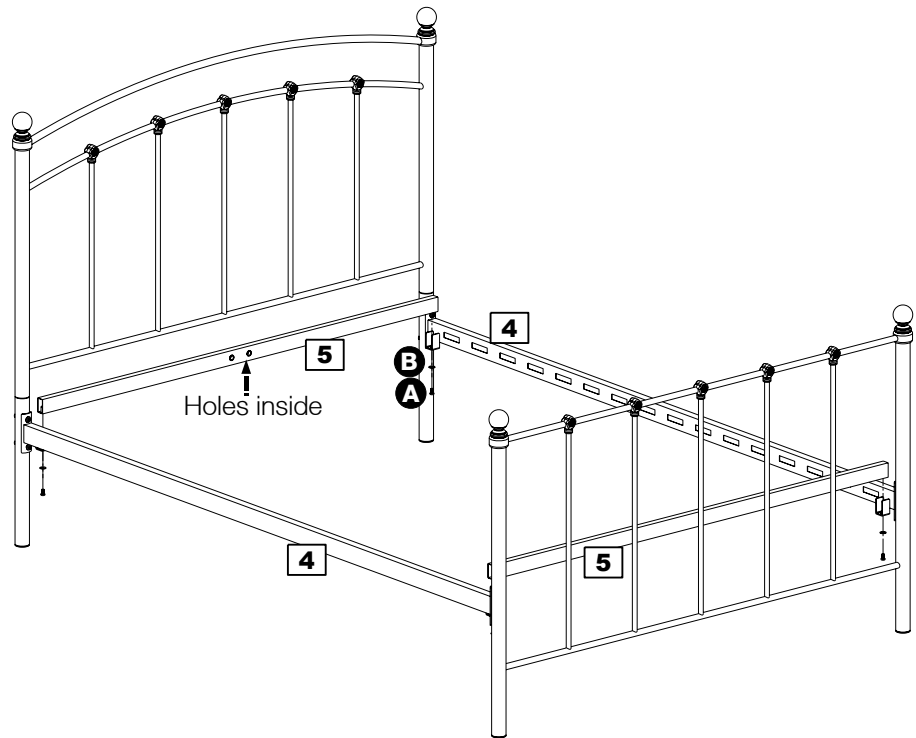

Step 4

Assembling central support

Locate central support **6** in between end supports **5** and secure using fixings **A** and **B**.

Assemble support legs **7** to the underside of central support **6** using fixings **B** and **G**.

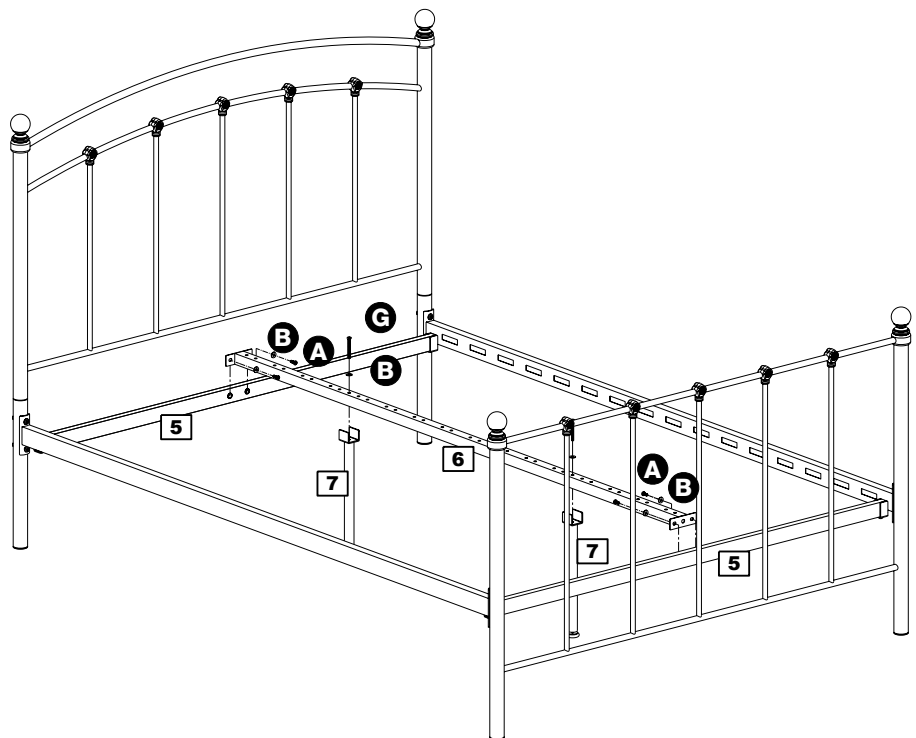

Assembly Instructions

Step 5

Attaching slat caps

Assemble plastic caps **K** onto one end of bentwood slats **8**

a: Fit plastic caps **K** into the slotted holes in side rails **4** as shown.

b: Fit bentwood slats **8** into both sides of central plastic caps **J** before pushing caps **J** into central support **6**.

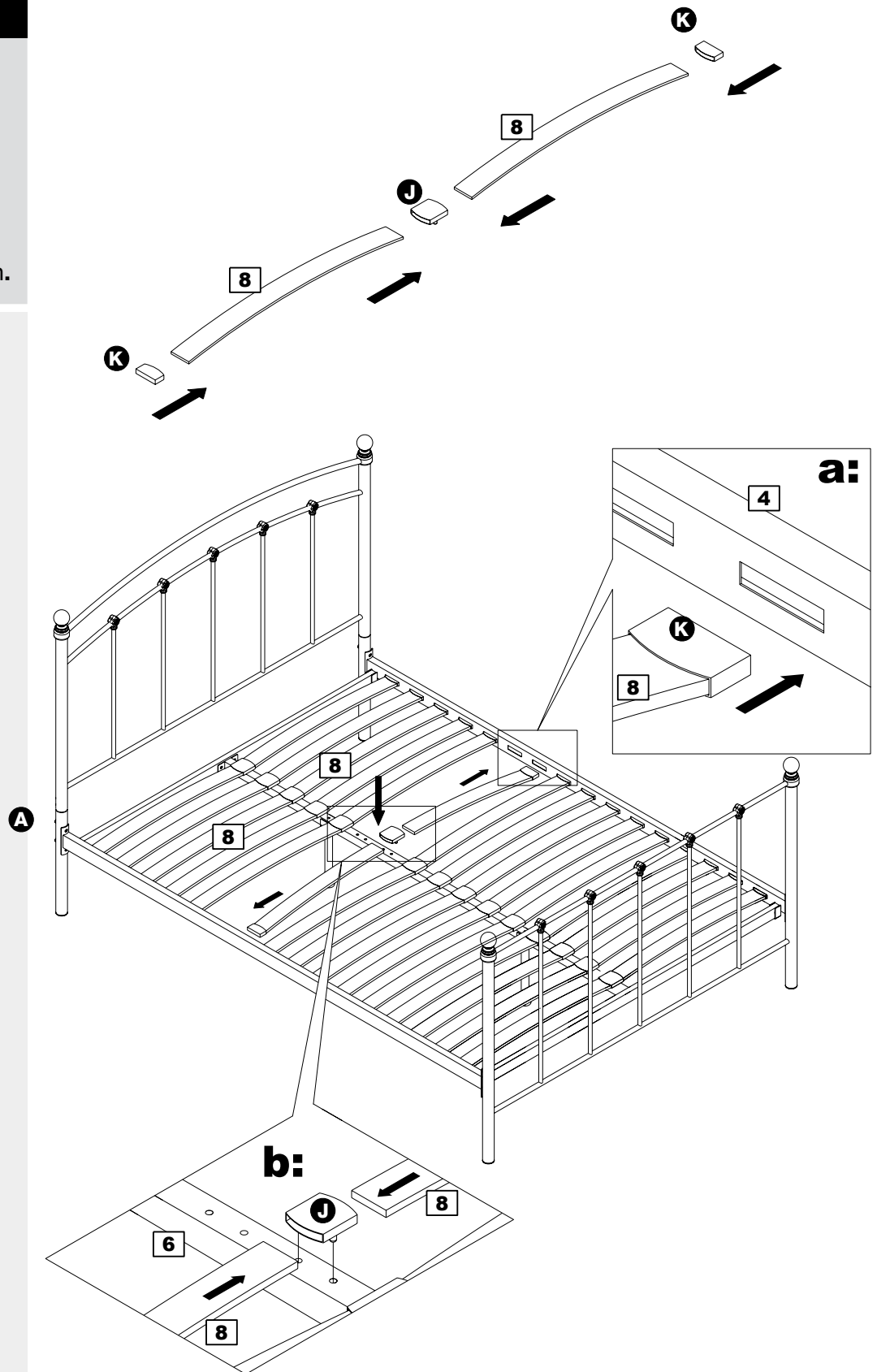

Assembly is complete.

If you need help or have damaged or missing parts, call the **Customer Helpline: 0345 6400 800**
Home Retail Group, 489-499 Avebury Boulevard, Saxon Gate West, Central Milton Keynes, MK9 2NW