

Taylor Bed 4FT

Assembly Instructions - Please keep for future reference

Cat.no 357 / 9703

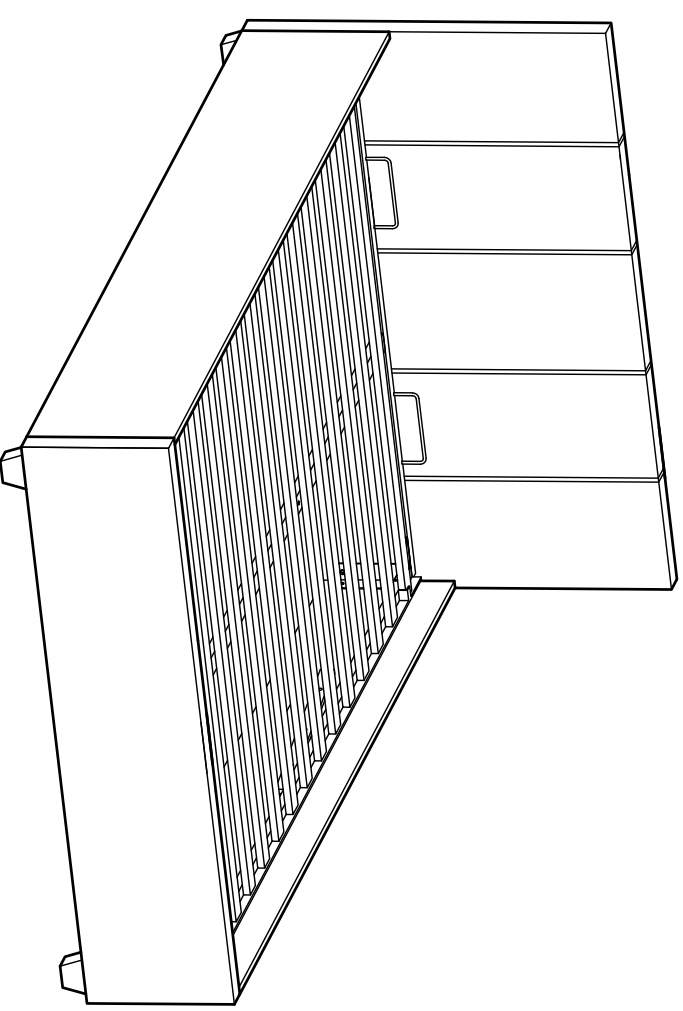

Dimension

Width - 128cm

Length - 206cm

Height - 98cm

Important - Please read these instructions fully before starting assembly

If you need help or have damaged or missing parts, call the **Customer Helpline: Argos = 0345 640 3030**



Safety and Care Advice

Important - Please read these instructions fully before starting assembly

- Check you have all the components and tools listed on pages 2 and 3.
- Remove all fittings from the plastic bags and separate them into their groups.
- Keep children and animals away from the work area, small parts could choke if swallowed.
- Make sure you have enough space to layout the parts before starting.
- Do not stand or put weight on the product, this could cause damage.
- Assemble the item as close to its final position (in the same room) as possible.
- Assemble on a soft level surface to avoid damaging the unit or your floor.
- Parts of the assembly will be easier with 2 people.
- We do not recommend the use of power drill/drivers **for inserting bolts** as this could damage the unit. Only use hand screwdrivers.
- Dispose of all packaging carefully and responsibly.
- Do not tighten all bolts until bed is fully assembled.



• We do not recommend the use of power drill/drivers **for inserting bolts** as this could damage the unit. Only use hand screwdrivers.

Care and maintenance

- Only clean using a damp cloth and mild detergent, do not use bleach or abrasive cleaners.
- From time to time check that there are no loose bolts on this unit.
- This product should not be discarded with household waste. Take to your local authority waste disposal centre.

Handy Hints

- Assemble all parts and bolts loosely during assembly, only once the product is complete should you fully tighten the bolts.
- Regularly check and ensure that all bolts and fittings are tightened properly.

Important Ottoman Safety Warnings

- **Caution.** This bed uses a pressurised mechanism.
- **Use caution when operating - Always use two hands at arm's length, and only where illustrated on the product.**
- **You must ensure the mattress is on the bed frame before lifting the mechanism - Failure to do so may result in injury.**
- **Please ensure Children and Pets are kept away from the bed when operating the bed mechanism.**
- **If removing the mattress, make sure that the frame is secured as it could flip open.**
- **Only use the storage compartment when the frame is fully raised in the 'up' position.**
- **No children or animals are left unattended when the frame is in the 'up' position.**
- **Do not remain on the bed whilst the lifting mechanism is in use.**
- **Beware of Entrapment - Keep both hands clear of mechanism when operating the mechanism.**
- **When lifting the bed remove all bedding - Except the fitted sheet.**

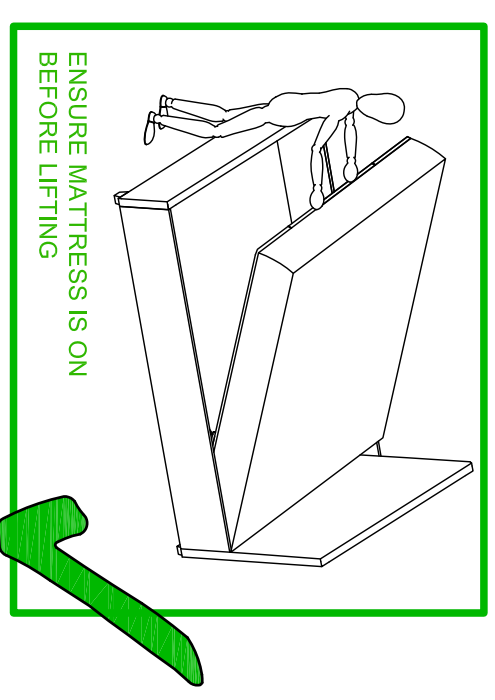
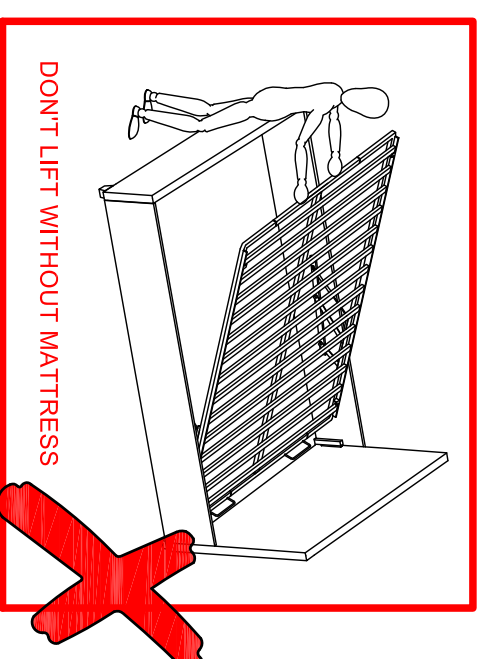

Components - Parts

If you have damaged or missing components, call the **Customer Helpline: Argos = 0345 640 3030**

Please check you have all the parts listed below

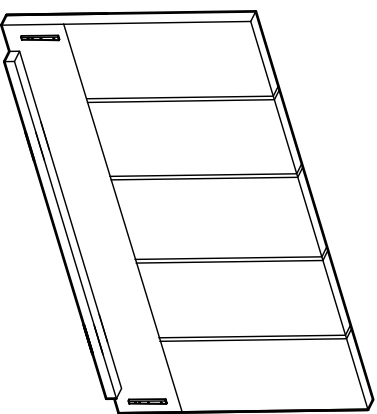

1 Headboard (128x92cm)

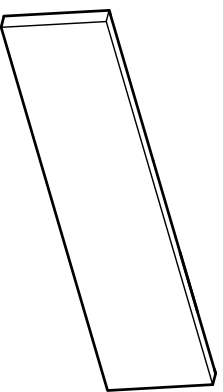

2 Footboard (128x33cm)

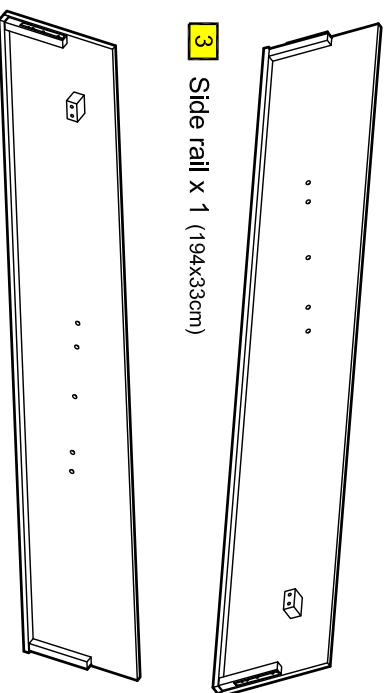

3 Side rail x 1 (194x33cm)

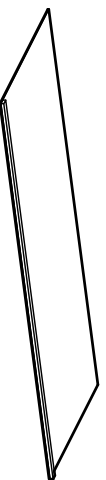

4 Side rail x 1 (194x33cm)

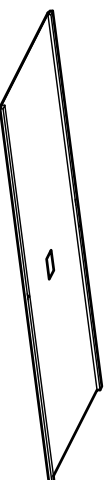

5 Hardboard base panel x 2 (123x64.7cm)

6 Hardboard base central panel x 1 (123x67cm)

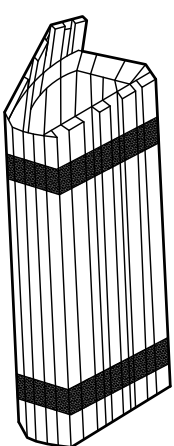

7 Slats (118.5x4.3cm)

Metal frame

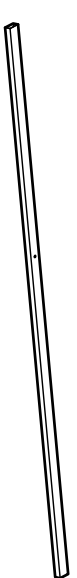

8 Middle rail x 1 (184x3cm)



9 Side rail x 1 (190x30cm)

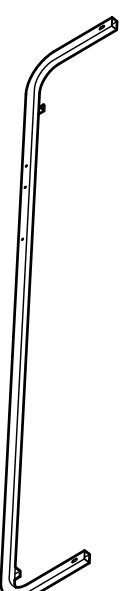

10 Side rail x 1 (190x30cm)

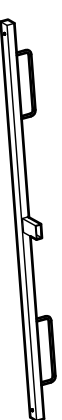

11 Back rail x 1 (72x9cm)

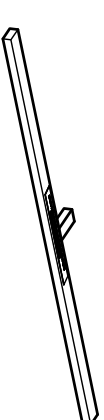

12 Front rail x 1 (72x9cm)



13 Metal Mechanism x 1 (62x9cm)



14 Metal mechanism x 1 (62x9cm)

Assembly Instructions

Step 8

Assembling the bed base

a: Insert Legs **G** into Hardboard central base panel **6** using Screws **B**.

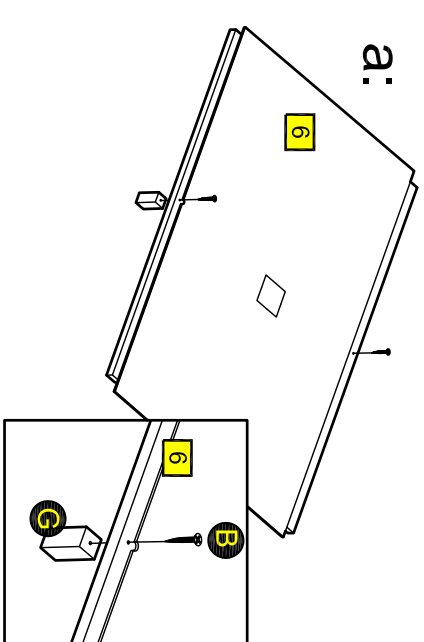

b: Place one Hardboard base panel **5** near the Headboard **1** then the Central Hardboard base panel **6**.

Then place the second Hardboard base panel **5** near the Footboard **2**.

Note : Ensure frame is square.

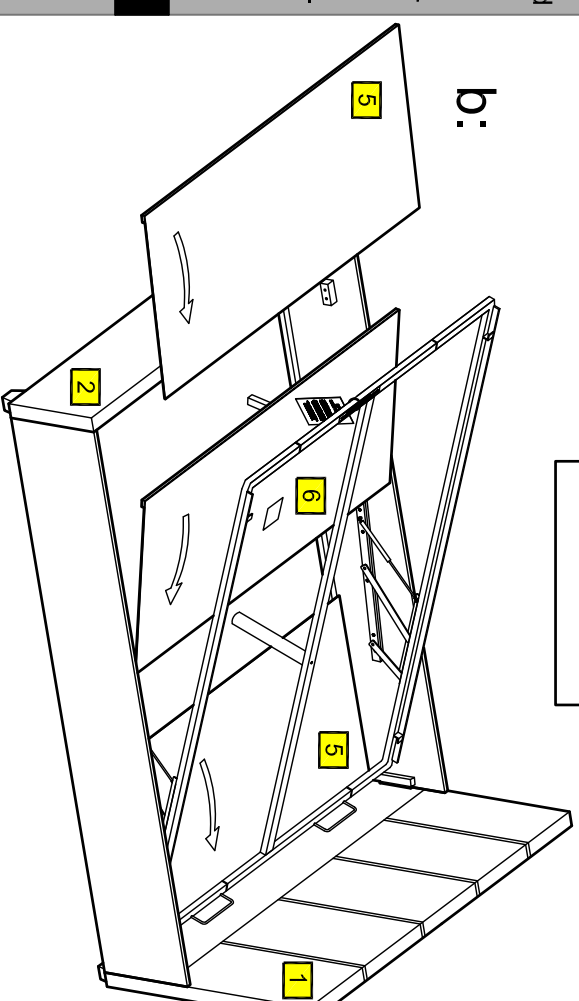

Step 9

Attaching slats

For this stage requires two people.

Roll the slats over the metal frame, then place the end slat after the metal block attached to the Side Rails **9** and **10**.

Slats to be rolled out with staples on the underside.

Repeat operation for all 4 corners.

Assembly is now complete.

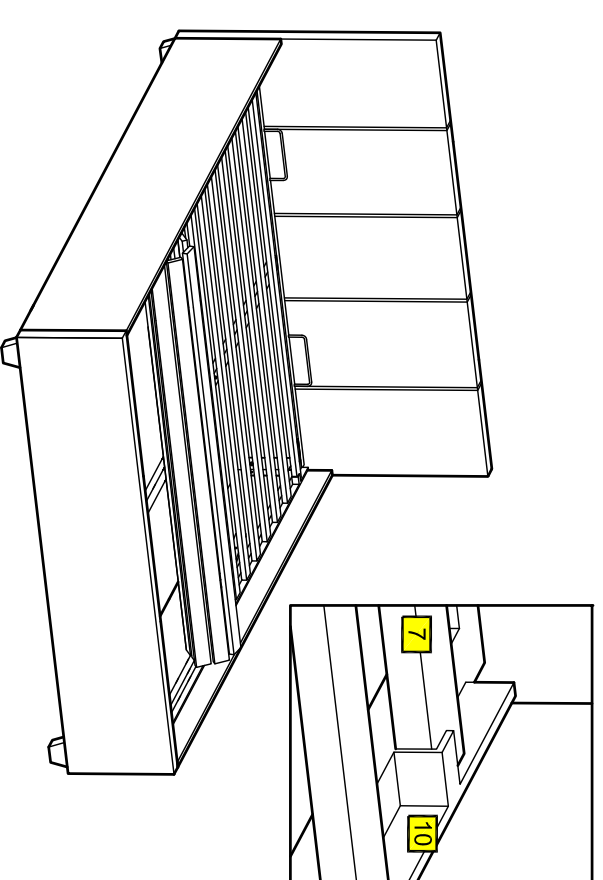

If you need help or have damaged or missing parts, call the **Customer Helpline: Argos = 0345 640 3030**

Assembly Instructions

Components - Fittings

Step 6

Attaching the mechanism

a: Fix the Mechanism **13** & **14** to the Metal Frame by inserting 3 Bolts **A** through the Mechanism, then through the metal Side rail **9** and **10**.

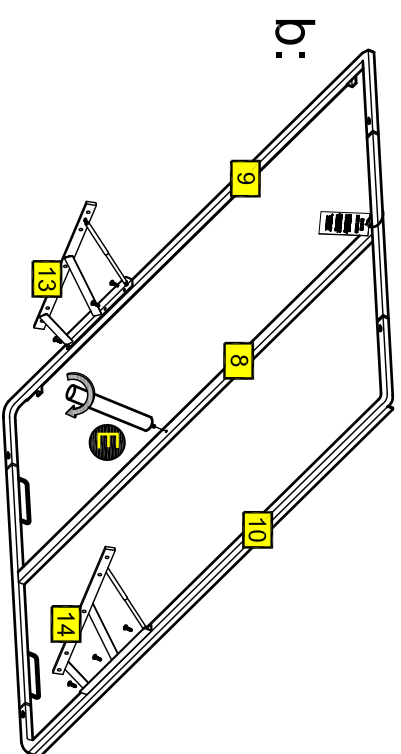

b: Insert Support leg **E** through the Middle Rail **8** and secure tightly in a clockwise direction.

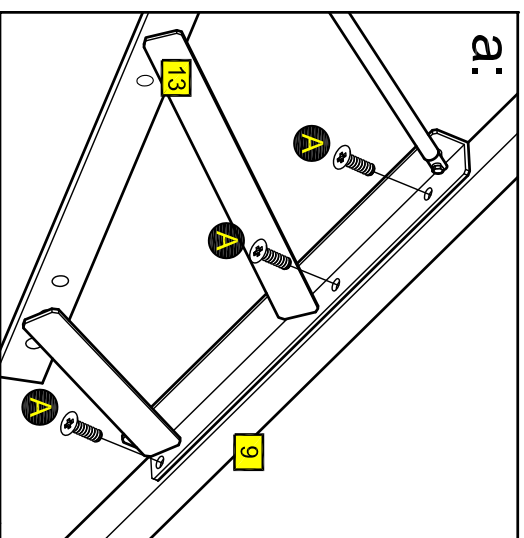

Step 7

Attaching the mechanism to the side rails

For this stage requires two people.

Insert 5 Bolts **C** through the Mechanism **13** & **14** through the Side rail **3** and **4**.

Make the same for the other side.



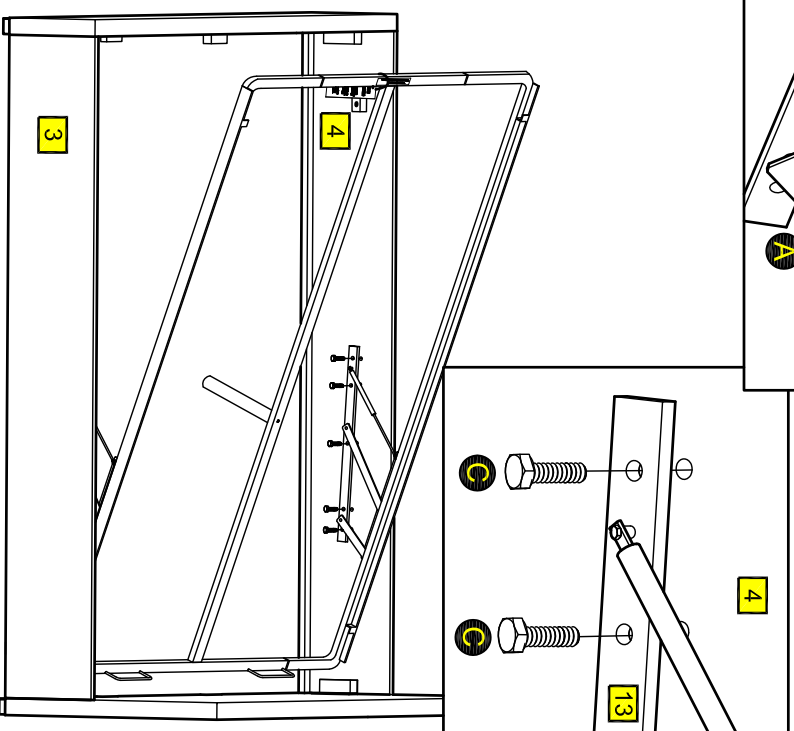



Now fully tighten all bolts.

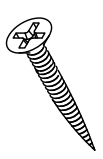
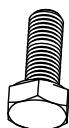

If you need help or have damaged or missing parts, call the **Customer Helpline: Argos = 0345 640 3030**

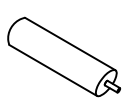
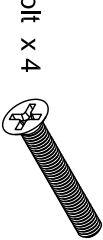
Please check you have all the fittings listed below

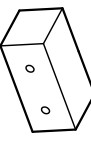
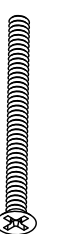
Note: the quantities below are the correct amount to complete the assembly. In some cases more fittings may be supplied than are required.

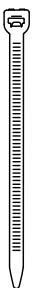
A M6x16 mm Bolt x 10		B 3.5x30 mm Screw x 2		C M8x35 mm Bolt x 10	
D Leg x 4		E Support leg x 1		F M8x50 mm Bolt x 4	
G Base leg x 2 (55x25mm) x 2		H Frame support (60x30mm) x 3		I M6x80 mm Bolt x 6	
J Warning label		K Cabletie			

Tools required

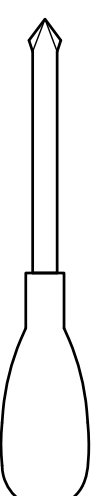

Screwdriver (Not supplied)

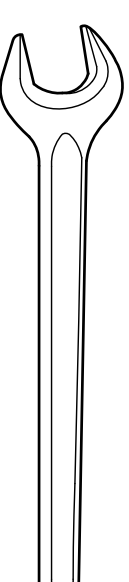

Key hexagonal 13 mm (Not supplied)

Ruler - Use this ruler to help correctly identify the bolts



Assembly Instructions

Step 1

Attaching legs

a: Insert Legs **D** into Headboard **1**, using Bolt **F**.

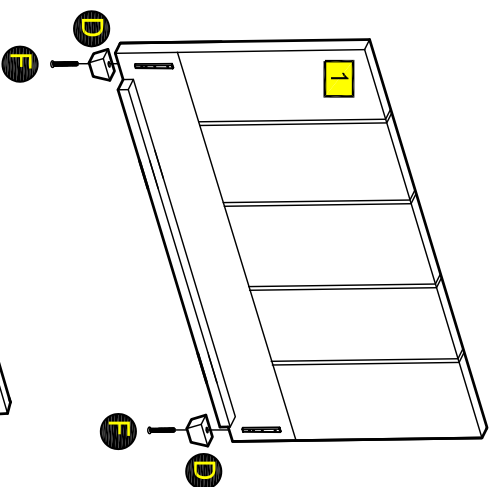

b: Insert Legs **D** into Footboard **2**, using Bolt **F**.

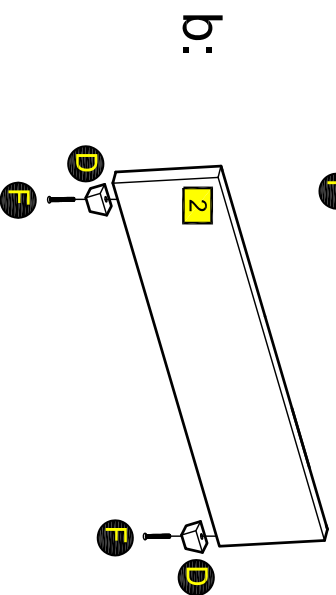

Step 2

Metal frame assembly

a: Insert Middle rail **8** into the Front rail **12** and Back rail **11**.

b: Connect the Side **9** & **10** to the Front rail **12** and Back rail **11** with Bolts **A**.

c: Fix Warning Label **J** on the Front rail **12** using Cabletie **K**.

The Middle rails **8** and Side rails **9** & **10** must be positioned with the holes closer to the Back rail **11**.

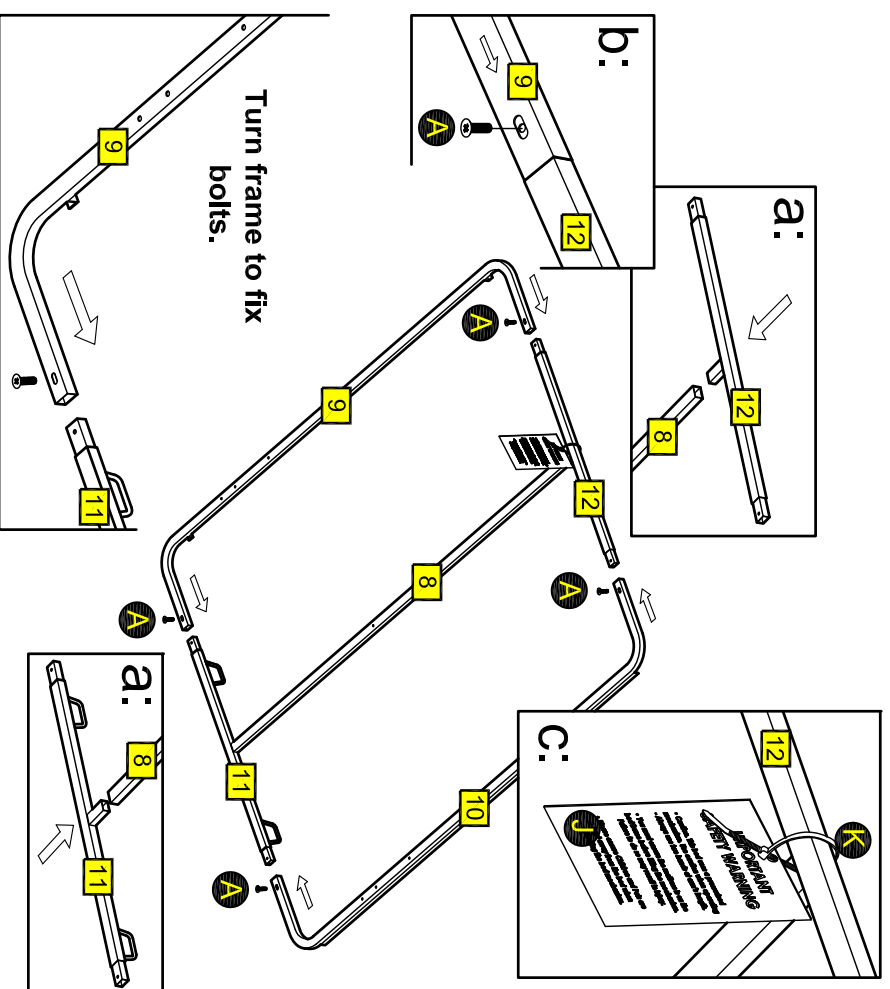

If you need help or have damaged or missing parts, call the **Customer Helpline: Argos = 0345 640 3030**

Assembly Instructions

Step 3

Attaching frame supports

Insert Frame supports **H** into Footboard **2** using Bolts **I**.

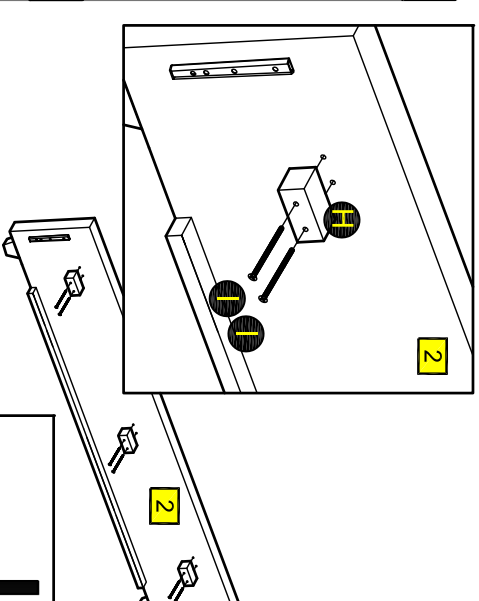

Step 4

Attaching side rails

Connect the Side rail **3** & **4** to Headboard **1** and Footboard **2** as seen in the picture.

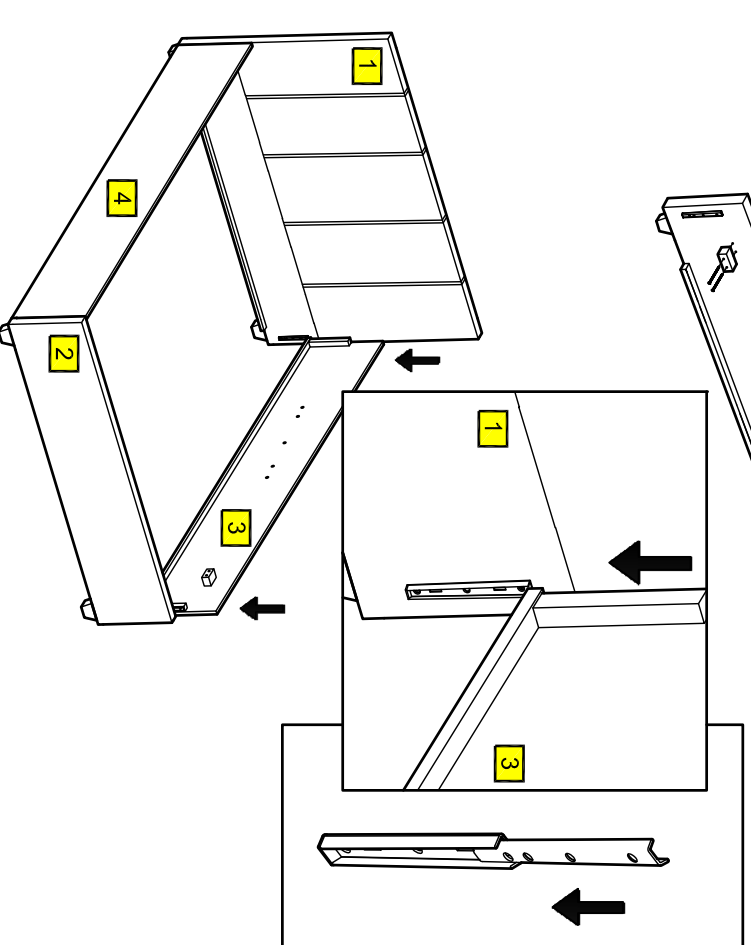

Step 5

Mechanism assembly

Remove the screw and place the piston over the hole, then fix the screw.

