

BUSH RETRO COMBI FRIDGE FREEZER

Installation & User Instructions - Please keep for future reference

6 G : * \$6 **
6 G : * \$F **
6 G : * \$7 **
6 G : * \$; '

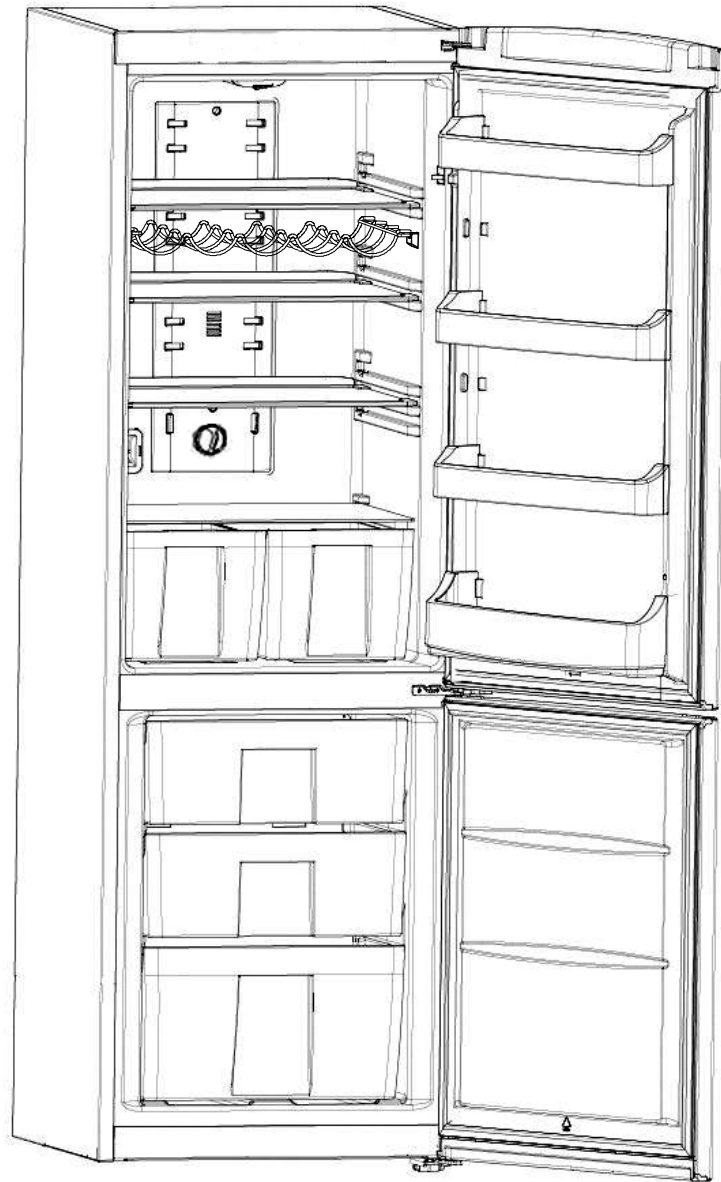

Important – Please read these instructions fully before installing or using

These instructions contain important information which will help you get the best from your appliance and ensure safe and correct installation, use and maintenance.

If you need help or have damaged or missing parts, call the **Customer Helpline: 0345 257 7271**

Description Of Product & Contents	3
General warnings	4
BEFORE USING THE APPLIANCE	4
Old and out-of-order fridges	5
Safety warnings	5
Installing and operating your fridge	6
Before Using your Fridge	6
FUNCTIONS AND CONTROLS	8
Thermostat settings	8
Warnings for Temperature Settings	8
ARRANGING FOOD IN THE APPLIANCE	9
The Deep Freeze Compartment	9
Cooling Compartment	9
CLEANING AND MAINTENANCE	11
Defrosting	11
SHIPMENT AND REPOSITIONING	12
Trouble Shooting	12
Replacing the Bulb	12
Repositioning the Door	12
BEFORE CALLING YOUR AFTER SALES	
SERVICE	13
Technical Specifications	15
Tips for saving energy	16
	16

Product code

BSFF60B
BSFF60R
BSFF60C
BSFF60G

Description Of Product & Contents

Customer Helpline: 0345 257 7271

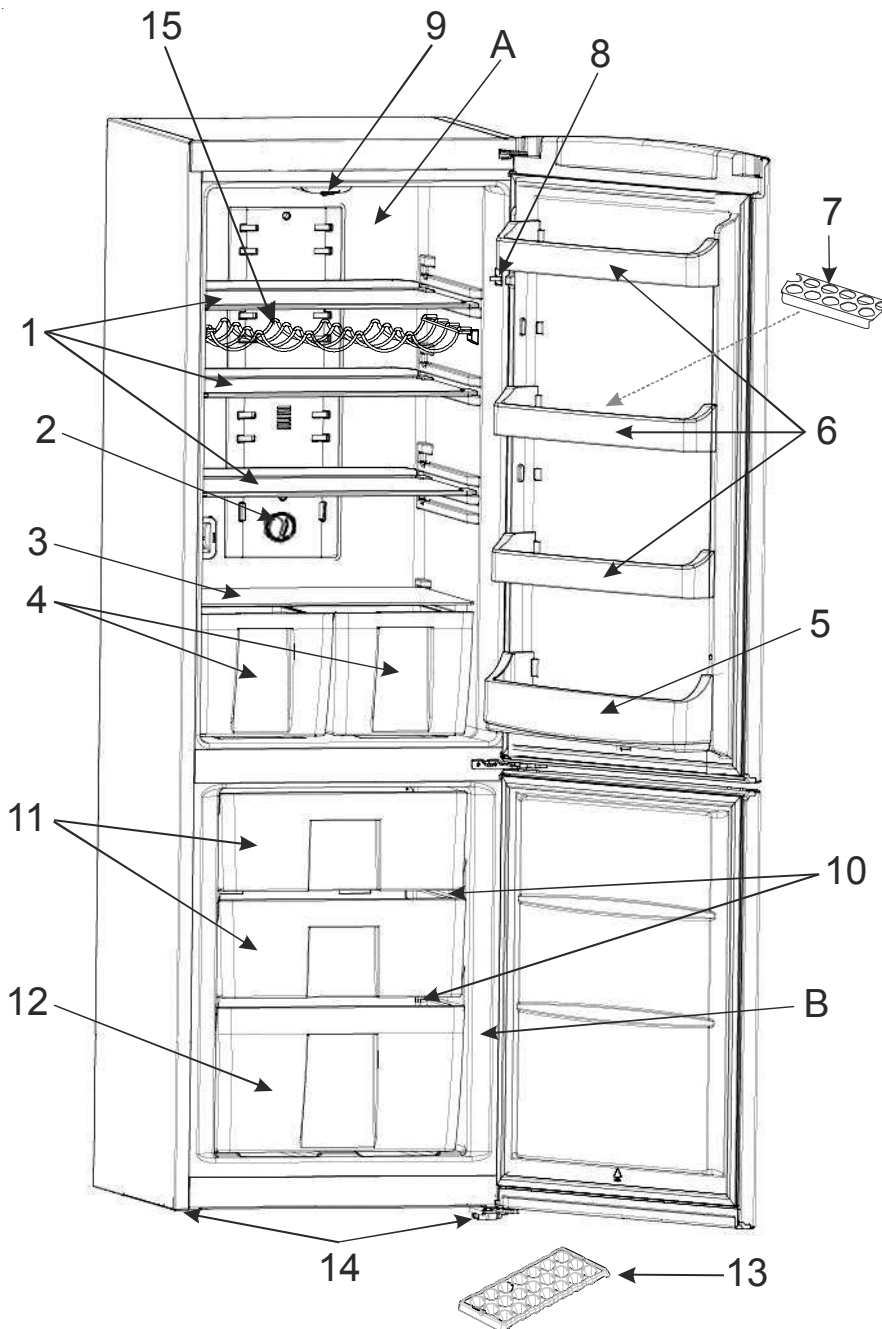

A) Cooling Compartment
B) Freezing Compartment

- 1) Glass Shelves x 3
- 2) Thermostat
- 3) Glass Above the Vegetable Holder
- 4) Vegetable Holders
- 5) Bottle-Holder
- 6) Upper Shelves x 3

- 7) Egg Holders x 2
- 8) Lamp switch
- 9) Fridge lamp and cover
- 10) Glass shelves x 2
- 11) Middle baskets x 2
- 12) Lower Basket x 1
- 13) Ice Tray x2
- 14) Leveling Feet x 2
- 15) Wine Rack x 1



BEFORE USING THE APPLIANCE

Customer Helpline: 0345 257 7271

Important - Please read these instructions fully before installation

General warnings

WARNING: Keep ventilation openings, in the appliance enclosure or in the built-in structure, clear of obstruction.

WARNING: Do not use mechanical devices or other means to accelerate the defrosting process, other than those recommended by the manufacturer.

WARNING: Do not use electrical appliances inside the food storage compartments of the appliance, unless they are of the type recommended by the manufacturer.

WARNING: Do not damage the refrigerant circuit.

WARNING: To avoid a hazard due to the instability of the appliance, it must be fixed in accordance with the instructions.

- This appliance contains the coolant Isobutane (R600a), a natural gas which is environmentally friendly. Although it is flammable, it does not damage the ozone layer and does not increase the greenhouse effect. The use of this coolant has, however, led to a slight increase in the noise level of the appliance. In addition to the noise of the compressor, you might be able to hear the coolant flowing around the system. This is unavoidable, but does not have any adverse effect on the performance of the appliance. Care must be taken during the transportation and installation of the appliance that no parts of the cooling system are damaged. Leaking coolant can damage the eyes.

In the event of any damage:

- Avoid open flames and anything which creates a spark,
- Disconnect from the mains,

- Air the room in which the appliance is located for several minutes

- Contact the Service Department for advice.

- Whilst carrying and positioning the appliance care must be taken not to damage the cooler gas circuit at the rear of the appliance

- Do not store explosive substances such as aerosol cans with a flammable propellant in this appliance.

- This appliance is not designed for commercial use. It is intended for use in domestic households only.

- This appliance is not intended for outdoor use. It must only be used as a domestic appliance to cool and store food as well as to store deep frozen food, freeze fresh food and to prepare ice.

- **If the socket does not match the refrigerator plug, it must be replaced by the manufacturer, its service agent or similar qualified persons in order to prevent any hazard occurring.**

- This appliance is not intended for use by persons (including children) with reduced physical, sensory or mental capabilities, or lack of experience and knowledge, unless they have been given supervision or instruction concerning use of the appliance by a person responsible for their safety. Children should be supervised to ensure that they do not play with the appliance.

- Before connecting the appliance, make sure that the connection data on the data plate (voltage and frequency) matches the mains electricity supply. This data must correspond in order to avoid the risk of damage to the appliance. Consult a qualified electrician if in any doubt.

Before using the appliance

Customer Helpline: 0345 257 7271

- Children 8 years and older may use the appliance only if they have been given clear instructions how to use it in a safe way manner and understand the hazards involved. Do not allow children to play with the packaging material, e.g. plastic bags and wrappings. Danger of suffocation.

- If the supply cord is damaged, it must be replaced by the manufacturer, its service agent or similar qualified persons in order to avoid a hazard.

Old and out-of-order fridges

- If your old fridge has a locking mechanism please ensure it is unusable before discarding it, as children may get trapped inside and it may cause an accident or injury.

- Old fridges and freezers contain isolation material and refrigerant with CFC. Therefore, take care not to harm the environment when you are discarding your old fridges.

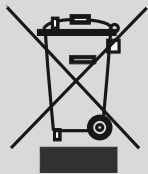

Please ask your local authority about the disposal of the WEEE products reuse, recycle and recovery purposes.

Notes:

- Please read the instruction manual carefully before installing and using your appliance. **We are not responsible of the damage occurred due to misuse.**
- Follow all instructions on your appliance and instruction manual, keep this manual in a safe place to resolve any problems that may occur in the future.
- This appliance is produced to be used in domestic households only. It is not suitable for commercial use. Such use will cause the guarantee of the appliance to be cancelled and our company will not be responsible for the losses that may occur.
- This appliance is produced to be used in domestic households and it is only suitable for cooling / storing foods. It is not suitable for commercial use and/or for storing substances except for food. Our company is not responsible for the losses that may occur by incorrect use.

Safety warnings

- Do not use extension leads when connecting this appliance.
- Do not plug in damaged, torn or old plugs.
- Do not pull, bend or damage the cord.



- This appliance is designed for use by adults, do not allow children to play with the appliance or let them to hang on the door.



- Do not insert or remove the plug from the socket with wet hands. Electrocutation and or injury may occur.

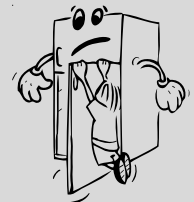

- Do not place glass bottles or cans in the freezer compartment. Bottles or cans may explode.

- Do not place explosive or flammable material in your fridge for your safety. Place drinks with higher alcohol content vertically and by closing their necks tightly in the fridge compartment.



- When taking ice made in the freezer compartment, do not touch it, ice may cause ice burns and/or cuts.



- Do not touch frozen goods with wet hands! Do not eat ice-cream and ice cubes immediately after you take them out of the freezer compartment!
- Do not re-freeze defrosted items. This may cause health issues like food poisoning.
- Do not cover the body or top of fridge. This affects the performance of your fridge.
- Ensure the accessories are secured during transportation to prevent damage.



Installing and operating your fridge

Before starting to use your fridge, you should pay attention to the following points:

- Operating voltage for your fridge is 220-240 V at 50Hz.
- We do not take the responsibility of the damages that occur due to ungrounded usage.
- Do not place your appliance in direct sunlight.
- Your appliance should be at least 50 cm away from stoves, Gas ovens and heaters, and should be at least 5 cm away from electrical ovens.
- Your fridge should never be used outdoors or left out in the rain.
- When your fridge is placed next to a deep freezer, there should be at least 2 cm between them to prevent humidity on the outer surface.
- Do not place anything on your fridge, and install your fridge in a suitable place so that there is at least 15cm clearance at the top.
- The adjustable front legs should stabilise in an appropriate height to allow your fridge to operate in a stable and proper way. You can adjust the legs by turning them clockwise (or in the opposite direction). This should be done before placing food in the fridge.



- Before using your fridge, wipe all parts with warm water, and then rinse and dry. Place all parts back in the appliance after cleaning.
- Install the distance adjustment plastic (the part with black vanes at the rear) by turning it 90° as shown in the figure to prevent the condenser from touching the wall.
- Refrigerators should be placed against a wall with a free distance of at least 75mm.

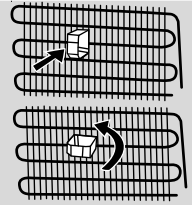

Before Using your Fridge

- Before switching on your appliance for the first time, ensure it is positioned in its desired final location and is in its upright position for at least 3 hours before plugging in and switching on the power. Otherwise you may damage the compressor.
- You may experience an odour from the appliance when it is operated for the first time. This is normal and will fade when your appliance starts to cool.

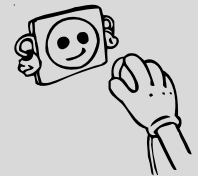

Information On No-Frost Technology

No-frost refrigerators differ from other static refrigerators in the way they work.

In static fridges, the humidity entering the fridge due to door openings and the humidity inherent in food causes freezing in the freezer compartment. To defrost the frost and ice in the freezer compartment, you are periodically required to turn off the appliance, place the food that needs to be kept frozen in a separately cooled container, and remove the ice gathered in the freezer compartment.

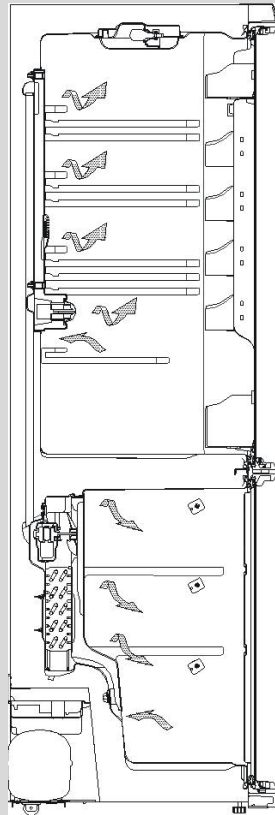

It is completely different in no-frost fridges. Dry and cold air is blown into the fridge and freezer compartments continuously and evenly from several points via a blower fan. Cold air dispersed continuously and evenly between the shelves cools all of your food equally and uniformly, thus preventing humidity and freezing.

Therefore your no-frost fridge allows you ease of use, in addition to its huge capacity and stylish appearance.

Thermostat settings

Cooler and Freezer Thermostat Knob

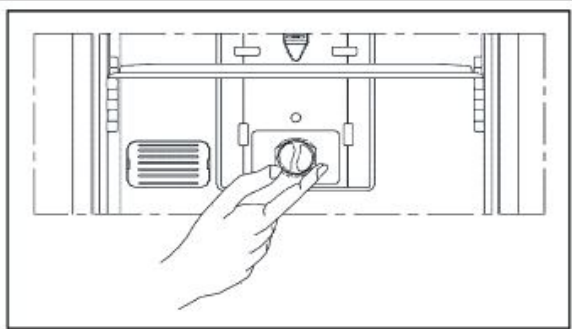

Cooling compartment

The thermostat ensures that the temperature settings in the cooling and freezing compartments of your refrigerator are controlled automatically. It may be set to any value ranging from 1 to 6. As you turn the thermostat setting control from 1 to 6, the amount of cooling increases.

Cooling compartment thermostat control:

5 - 6 : For higher cooling / summer use / full fridges

3 - 5 : For normal use.

1 - 3 : For lower cooling / winter use / empty fridges

Warnings for Temperature Settings

- It is not recommended that you operate your fridge in environments colder than 10°C in terms of its efficiency.
- The thermostat setting should be done by taking into consideration how often the fresh food and freezer doors are opened and closed, how much food is stored in the refrigerator, and the environment in which the refrigerator is located.
- Your fridge should be operated up to 24 hours according to the ambient temperature without interruption after being plugged in to be completely cooled. Do not open doors of your fridge frequently and do not place much food inside it in this period.
- A 5 minute delaying function is applied to prevent damage to the compressor of your fridge, when you take the plug out and then plug it on again to operate it or when a power cut occurs. Your fridge will start to operate normally after 5 minutes.

- Your fridge is designed to operate in the ambient temperature intervals stated in the standards, according to the climate class stated in the information label. It is not recommended that your fridge is operated in the environments which are out of the stated temperature intervals in terms of cooling efficiency.

<i>Climate Class</i>	<i>Ambient</i>
T	16 to 43 °C
ST	16 to 38 °C
N	16 to 32 °C
SN	10 to 32 °C

ARRANGING FOOD IN THE APPLIANCE

Customer Helpline: 0345 257 7271

Cooling Compartment

- To prevent humidity and odour forming, the food should be placed in the refrigerator in closed or covered containers.
- Hot foods and drinks should be cooled to room temperatures before being placed in the refrigerator.
- Please do not place packaged food and containers against the lamp or cover of the cooling compartment.
- Fruits and vegetables may be placed directly in the vegetable holder without being wrapped separately.
- Some recommendations have been specified below for the placement and storage of your food in the cooling compartment.

NOTE: Potatoes, onions and garlic should not be stored in the refrigerator. Meat should never be refrozen after it is thawed.

The Deep Freeze Compartment

- Use the deep freeze compartment of your refrigerator for storing the frozen food for a long time and for producing ice.
- To get maximum capacity from your freezer compartment, please just use the glass shelves for upper and middle section. For bottom section, please use lower basket.
- Place the food you would like to freeze initially in the upper shelf of the deep freeze section. You may place your food next to the other frozen foods after they are frozen (for at least 24 hours).
- It is recommended to keep thermostat set at level 5.
- It is recommended that the food which is being newly frozen be kept separate from the already frozen food.
- Do not refreeze the frozen food once it is thawed. It may pose a danger to your health
- Do not place hot meals in your deep freeze until they cool down. You could cause the

other food frozen beforehand in the deep freeze compartment to become spoiled.

- As you buy frozen food, make sure it was frozen under appropriate conditions and that the packaging is not torn.
- While storing frozen food, the storage conditions on the package should be observed. If there are no instructions, the food has to be consumed in the shortest period of time.
- Frozen food has to be transported before it thaws and it should be placed in the fast freezing shelf as soon as possible. Please do not use the baskets for fast freezing purposes.
- The storage durations of frozen food depend on the environmental temperatures, the frequent opening and closing of the doors, thermostat settings, food types, and the period of time that has elapsed from when the food was acquired to the time it entered the freezer. Always abide by the instructions on the package and never exceed the storage duration.
- During power cuts, please do not open the door of the deep freeze compartment. Your refrigerator will preserve your frozen food in the ambient temperature of 25°C for about 13 hours. This preservation time period decreases the higher the ambient temperatures are. During extended power cuts, you should not refreeze your food and should be disposed of accordingly.

Note: *Frozen foods, when thawed, should be cooked just like fresh foods. Once food is thawed, it must NEVER be re-frozen.*

Food in liquid form should be frozen in suitable plastic sealed containers. Other food types can also be frozen in suitable plastic sealed containers or alternatively freezer bags.

CLEANING AND MAINTENANCE

Customer Helpline: 0345 257 7271

- Make sure you unplug the fridge before starting to clean it.

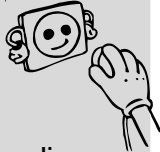

- Do not pour water directly over your appliance.



- You can wipe the inner and outer sides with a soft cloth or a sponge using warm soapy water.

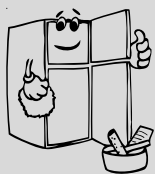
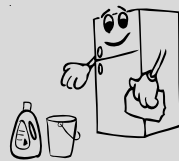

- Remove parts individually and clean by hand with soapy water. Do not place in dishwashers.

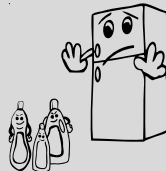

- Never use flammable, explosive or corrosive material for cleaning your appliance.

- You should clean the condenser periodically to keep your appliance running efficiently.

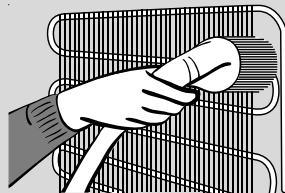

Make sure your appliance is unplugged before cleaning.

Defrosting

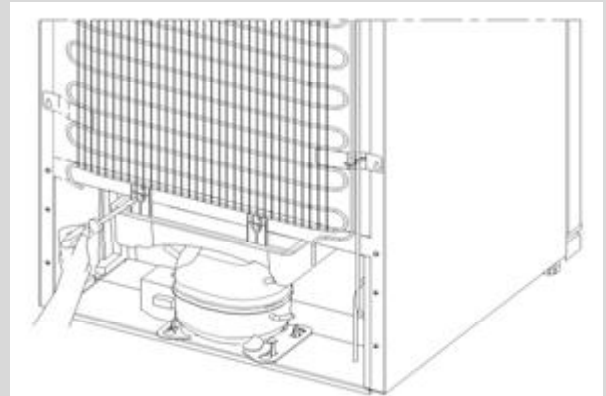

- Your refrigerator performs fully automatic defrosting. The water formed as a result of defrosting passes through the water collection spout, flows into the vaporization container behind your refrigerator and evaporates by itself in there.
- ***Make sure you have disconnected the plug of your refrigerator before cleaning the drainage tray.***
- Remove the drainage tray from its position by unscrewing the screws as indicated. Clean it with soapy water periodically to avoid odours and smells.

Replacing the Bulb

To replace the bulb in the freezer and fridge compartments;

- 1- Unplug your fridge.
- 2- Carefully remove the light cover from the top panel.
- 3- Replace with the same type wattage bulb.
- 4- Reinstall the light cover.
- 5- Wait for 5 minutes before re-plugging the fridge in and restore the thermostat to its original position.

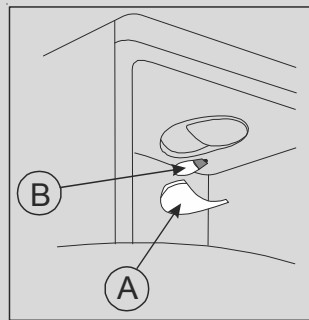

SHIPMENT AND REPOSITIONING

- Original packaging and foam may be kept for re-transportation (optional).
- You should fasten your fridge with thick packaging, bands or strong cords and follow the instructions for transportation on the packaging for re-transportation.
- Remove all movable parts (shelves, accessories, vegetable bins etc.) or fix them into the fridge so that they are secure and do not move.
- Carry your appliance in an upright position only.

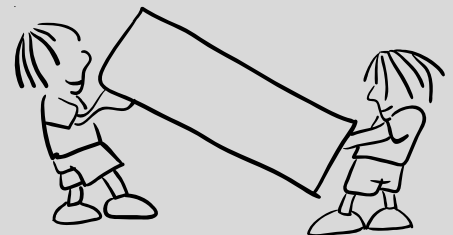

Repositioning the Door

IT IS NOT POSSIBLE ON THIS MODEL TO CHANGE THE OPENING DIRECTION OF YOUR APPLIANCES DOORS

BEFORE CALLING YOUR AFTER SALES SERVICE

Customer Helpline: 0345 257 7271

If your refrigerator is not working:

- Is there an electrical failure?
- Has the plug been correctly connected to the socket?
- Has there been a blow-out in the fuse or breaker of the electrical circuit to which the plug has been connected?
- Are there any faults with the socket? For this purpose, try the plug of your refrigerator by connecting it to a socket which you are sure is working.

If your refrigerator does not get cold enough:

- Is the thermostat set correctly?
- Are the doors of your refrigerator opened very frequently and do they remain open for long periods of time?
- Do the doors of your refrigerator fully close and are the door gaskets sealed correctly?
- Are any containers or dishes placed in your refrigerator touching the back wall in such a way that they are obstructing the air circulation?
- Is your refrigerator over-filled?
- Is there enough space between your refrigerator and the back and side walls?

If the food in the Cooling/Freezing compartment is colder than necessary:

- Has a suitable temperature been selected ?
(Is the thermostat control selected as position "5"?)
- Is there too much newly placed food in the deep freeze compartment?

If there is, the compressor shall operate longer for freezing it; hence it may also possibly be cooling the food in the cooling compartment more than necessary.

If your refrigerator is operating noisily:

The compressor shall from time to time energize to ensure that the adjusted coolness level remain fixed. The noise that may be heard from the refrigerator at that time is normal.

Once the required coolness level has been achieved, the noise should automatically reduce.

If there is still noise:

- Has your refrigerator been leveled? Have the feet been adjusted and set correctly?
- Is there anything behind your refrigerator?
- Are the shelves or the plates on the shelves of your fridge vibrating? If so, then rearrange the shelves and/or accordingly.
- Are the goods placed in the appliance vibrating? Secure them or rearrange on the shelf.

Crackling (Ice Cracking) Noise:

- It is sometimes heard during the automatic defrosting process as the ice which has formed on the cooling coil melts and falls into the drainage tray.

Short Cracking Noise: It is sometimes heard when the thermostat turns the compressor on and off.

Compressor Noise:

- It is a normal engine noise. This noise indicates that the compressor is operating normally.
- As the compressor first switched on, it might run a bit more noisy initially for a short period of time.

Bubbling and gurgling sound: This noise is emitted as the coolant fluid flows through the pipes within the system.

Water flowing sound: This is the normal sound of water flowing into the drainage tray during the defrosting process.

Air blowing sound: It is the normal fan sound. This sound may be heard due to air circulation in No Frost refrigerators when the system is operating normally.

If the edges of the refrigeration cabinet near the door seals are hot:

- Especially in summer months (in hot weather), there might be warming of the surfaces contacted by the seal on the refrigerator. This is normal.

If there is moisture on the inner parts of your refrigerator:

- Has the food been properly packaged and sealed? Have the containers been well dried before they were put into the refrigerator?
- Are the doors of the refrigerator opened very frequently? Once the door is opened, the humidity found in the air enters the refrigerator. Especially if the humidity levels in the room are very high. The more frequently the door is opened, the faster the humidification.

If the doors are not being properly closed:

- Is food preventing the doors from closing?
- Have the door compartments, shelves and drawers been properly positioned?
- Are the door seals defective or torn?
- Is your refrigerator standing on level ground?

IMPORTANT NOTES:

- In case of a sudden power loss or disconnecting and reconnecting of the plug to the electrical socket, the compressor protective thermal element will be opened as the pressure of the gas in the cooling system of your refrigerator has not yet been balanced. In 4 or 5 minutes, your refrigerator will start to operate; this is normal.
- If you won't be using your refrigerator for a long time (such as on summer holidays), please disconnect the plug from the socket. Clean your refrigerator as per Part 4 of these instructions and leave the door open to prevent any humidification or odour forming.
- If the problem persists after you have followed all the instructions above, please consult to our authorised service agent.
- The appliance you have purchased is designed for home use and can be used only at home for the stated purposes. It is not suitable for commercial use. If the consumer uses the appliance in a way that does not comply with these features, we emphasise

we shall not be responsible for any repair and failure within the guarantee period.

- The lifetime of your appliance stated and declared by the Department of Industry (the period for retaining parts required for the proper functioning of the appliance) is 10 years.

Technical Specifications

Customer Helpline: 0345 257 7271

Supplier's name or trade mark	BUSH
Model / Item	BSFF60B BSFF60R BSFF60C BSFF60G
Type of appliance	GT/N366
The energy efficiency class	A+
Voltage	220-240V / 50 Hz
Power	174 W
Energy consumption	0,836 kw/24h - 305 kw/year
Net storage volume of fresh food	231 lt.
Net storage volume of frozen food	87 lt.
Star rating of frozen food storage compartment	4
Power cut failure safe storage	780 mins (25°C) 600 mins (32°C)
Freezing capacity'	4,2 Kg
Climate class'	T/N (16°C - 43°C)
Size (mm) (W x D x H)	595 x 632,5 x 1855
Noise'	45 dB (A)

We apologise for any inconvenience caused by minor changes or inconsistencies in these instructions that may occur as a result of product improvements and development.

Conformity Information

- This equipment is designed for use at an ambient temperature within the 16°C - 43°C range
- The appliance is designed in compliance with the IEC60335-1 / IEC60335-2-24, 2004/108/EC standards.

- 1– Install the appliance in a cool, well ventilated room , but not in direct sunlight or near heat sources (radiators, cooker, etc....).
- 2– Allow warm food and drinks to cool down before placing in the appliance.
- 3– When thawing frozen food, place it in the refrigerator compartment. The frozen food will help to cool the refrigerator compartment when it is thawing.
- 4– When placing liquids in the appliance they must be covered.
- 5– When placing food and drinks, open the appliance door as briefly as possible.
- 6– Keep closed the covers of any different temperature compartments in the appliance (crisper, chiller ...etc).
- 7– Door seals should be kept clean and undamaged.

Guarantee



Product Guarantee

This product is guaranteed against manufacturing defects for a period of



This product is guaranteed for twenty four months from the date of original purchase. Any defect that arises due to faulty materials or workmanship will either be replaced, refunded or repaired free of charge where possible during this period by the dealer from whom you purchased the unit.

The guarantee is subject to the following provisions:

- The guarantee does not cover accidental damage, misuse, cabinet parts, knobs or consumable items.
- The product must be correctly installed and operated in accordance with the instructions contained in this manual.
- It must be used solely for domestic purpose.
- The guarantee will be rendered invalid if the product is re-sold or has been damaged by inexpert repair.
- Specifications are subject to change without notice.
- The manufacturer disclaims any liability for the incidental or consequential damages.
- The guarantee is in addition to, and does not diminish your statutory or legal rights.
- In the event of a problem with the product with in the guarantee period call the Customer Helpline: **0845 600 4632**.

Guarantor: Argos Ltd
489 - 499 Avebury Boulevard
Central Milton Keynes
MK9 2NW

RE-WIRING YOUR PLUG

For your safety please read the following information

Warning: This appliance must be earthed.

This appliance operates from 220-240 volts and should be protected by a 13 amp fuse in the plug.

The appliance is supplied with a standard 13 amp 3-pin mains plug fitted with a 13-amp fuse. Should the fuse require replacement, it must be replaced with a fuse rated at 13 amp and approved to BS1362.

If the mains plug which is fitted is unsuitable for the socket outlet in your home or is removed for any other reason, please follow the instructions below on how to wire a 13 amp 3 pin plug..

How to wire a 13 amp plug.

Important

The wires in the mains lead on this appliance are coloured in accordance with the following code:

Green and Yellow - Earth

Blue – Neutral

Brown – Live

As the colours may not correspond with the markings identifying the terminals in your plug proceed as follows.

The green and yellow wire must be connected to the terminal in the plug which is marked with the letter E or with the earth symbol \equiv or coloured green and yellow.

The blue wire must be connected to the terminal marked N.

The brown wire must be connected to the terminal marked L.

You must make sure the lead is firmly secured under the cord clamp.

