

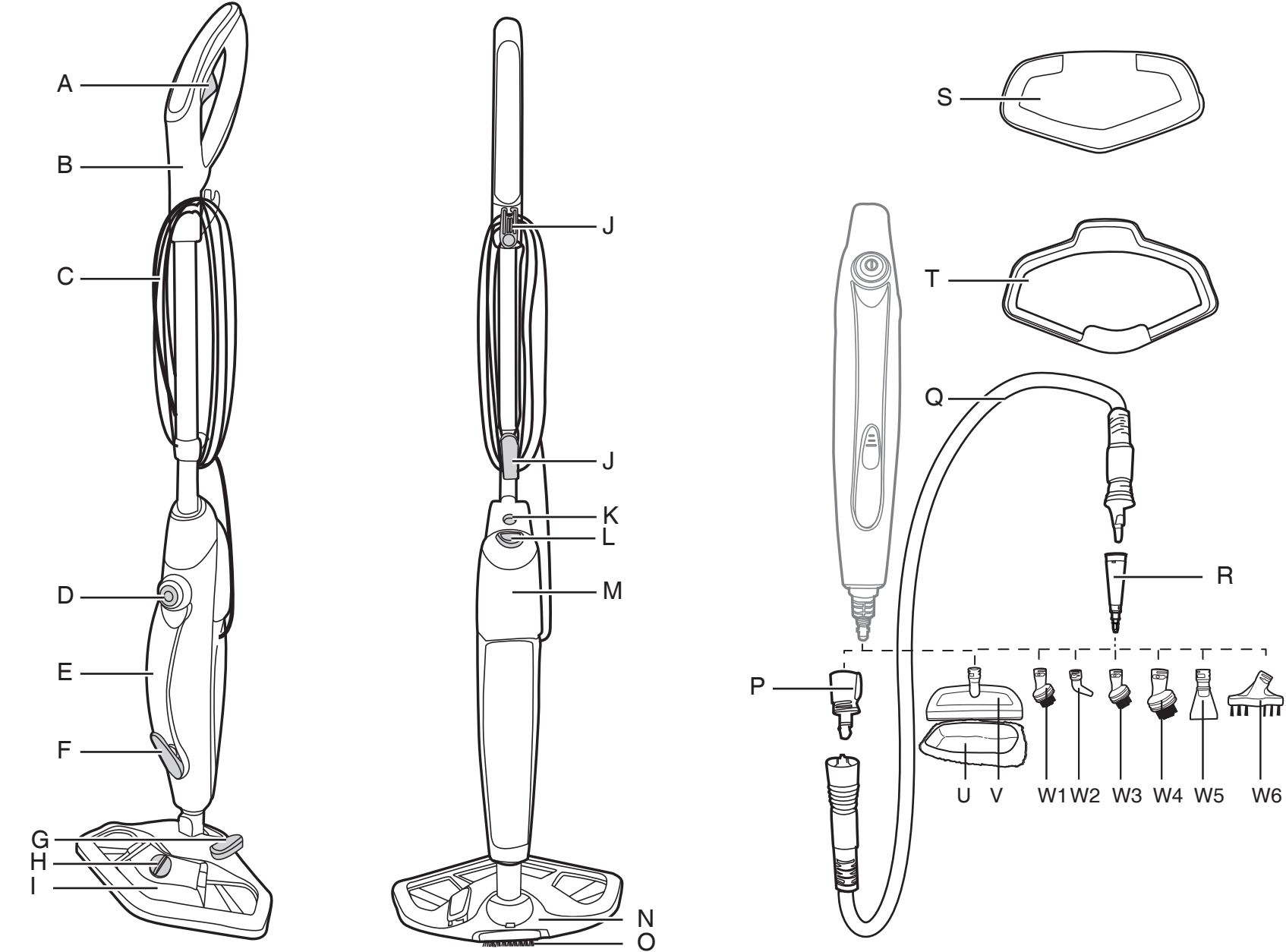

# HOOVER



PRINTED IN P.R.C.  
48013572



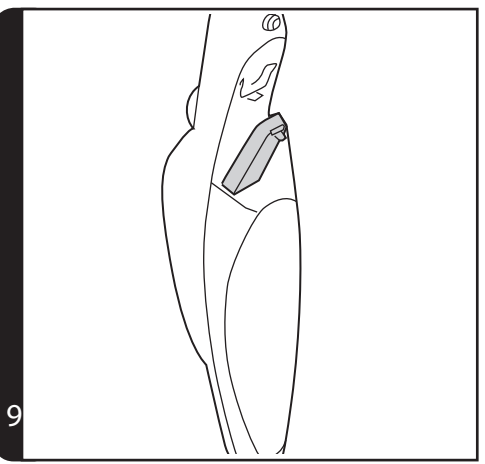
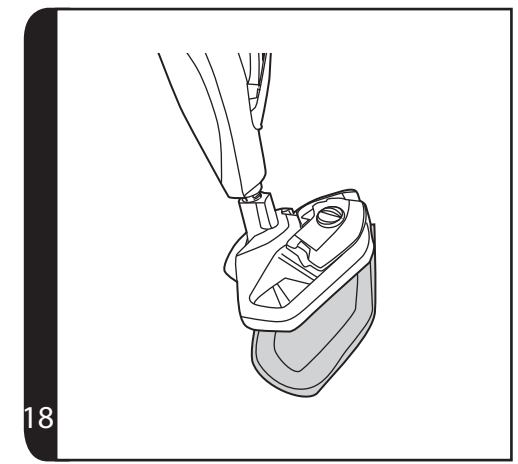
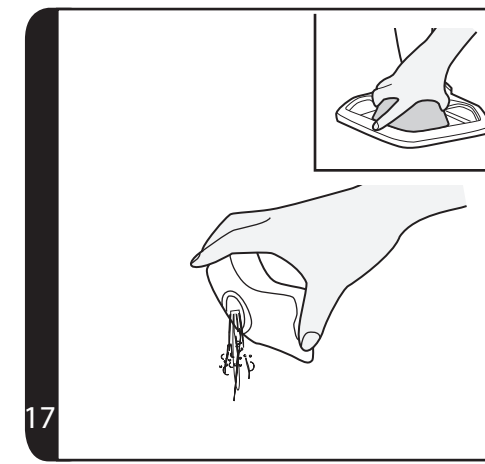
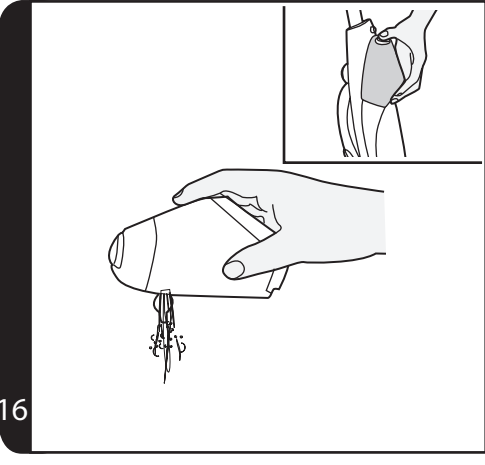
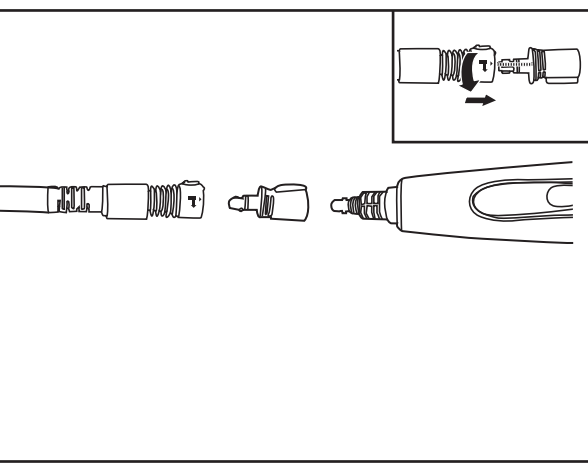
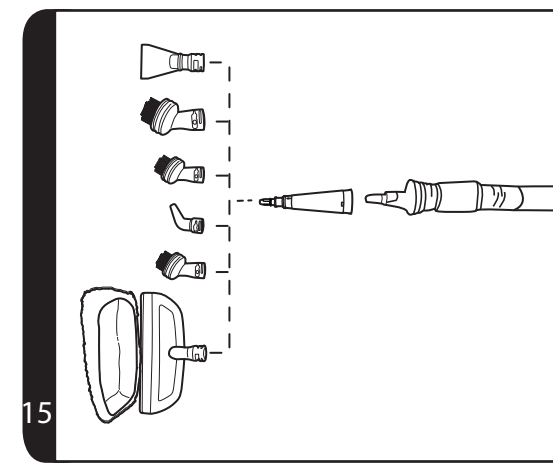
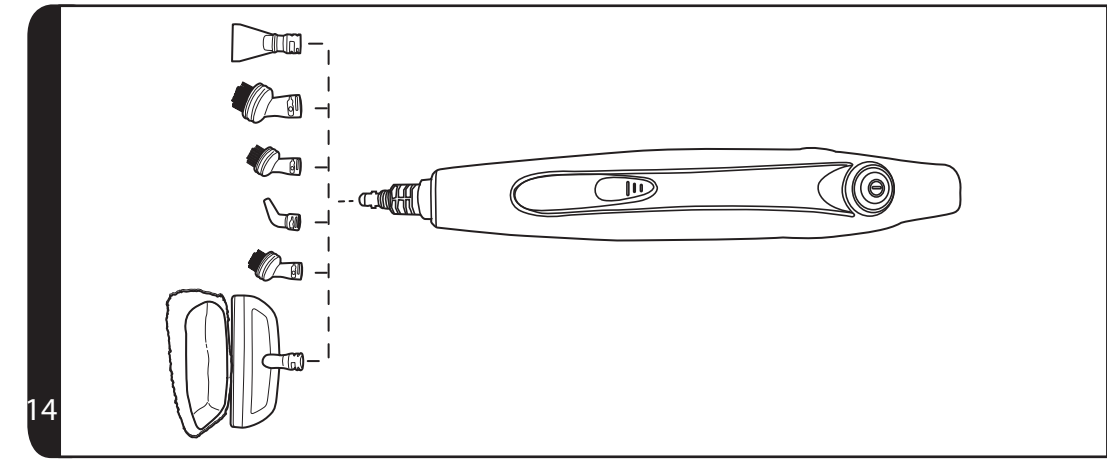
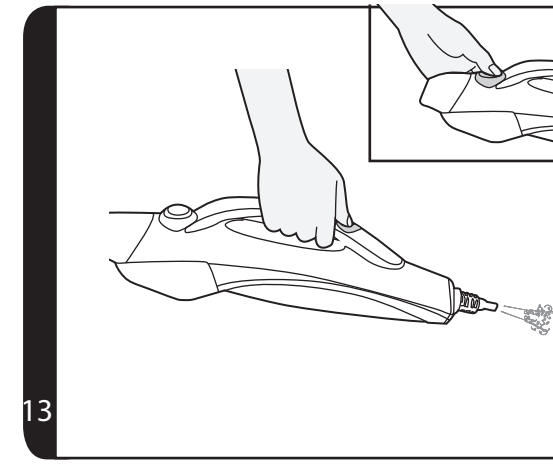
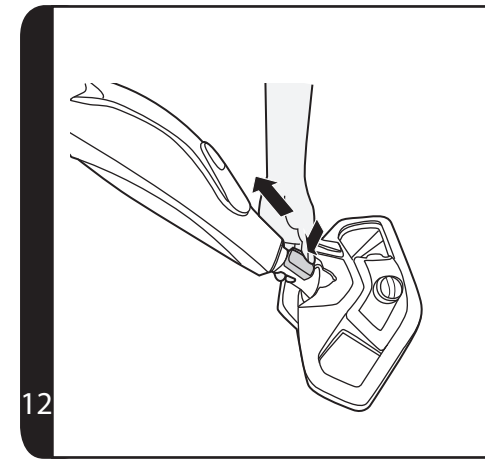
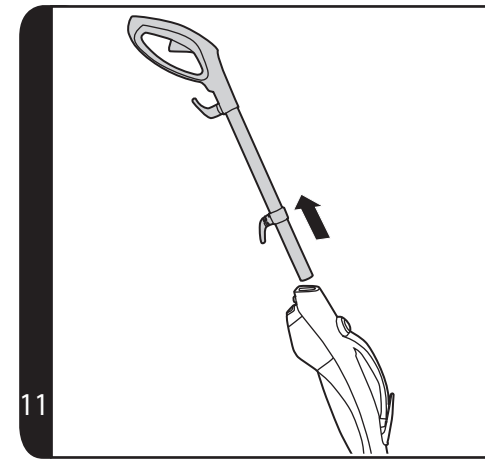
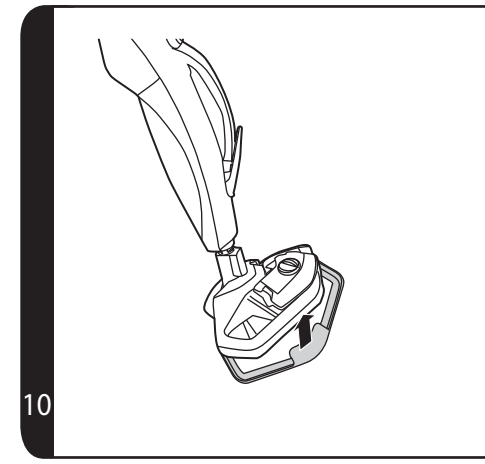
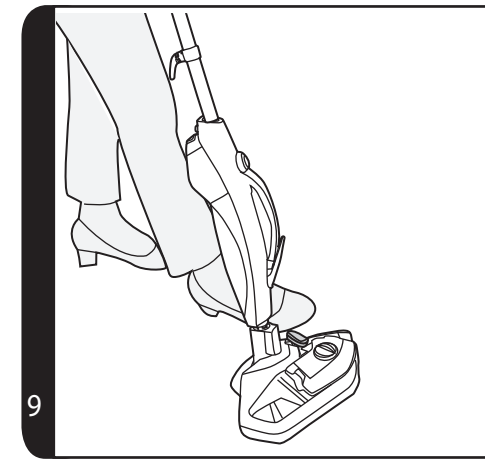
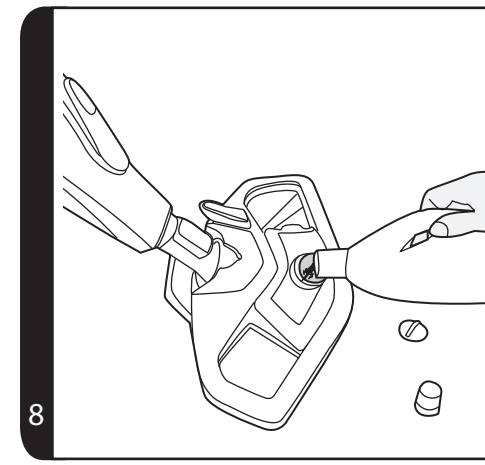
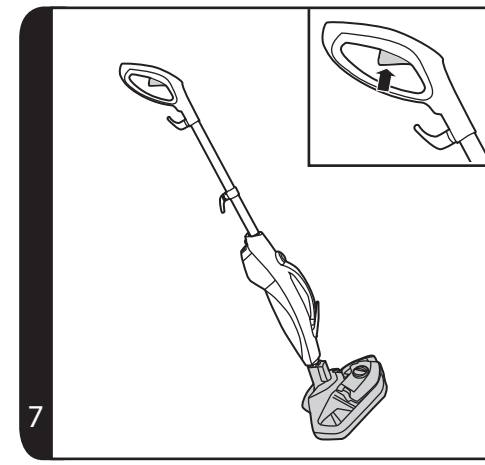
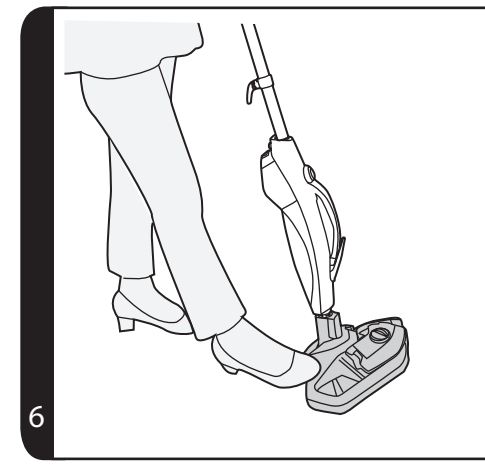
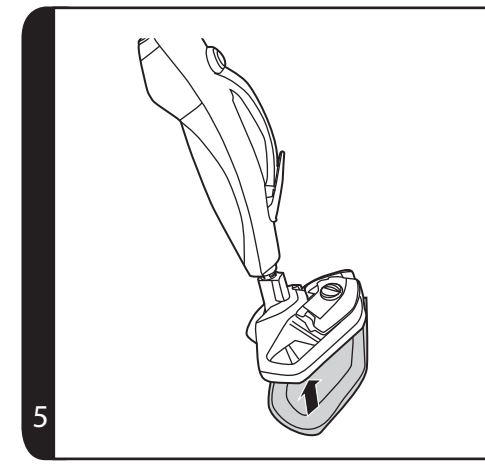
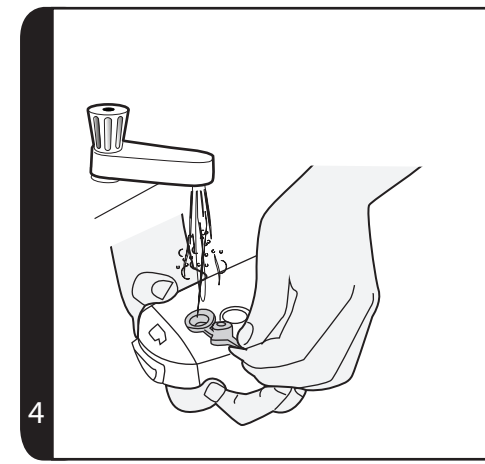
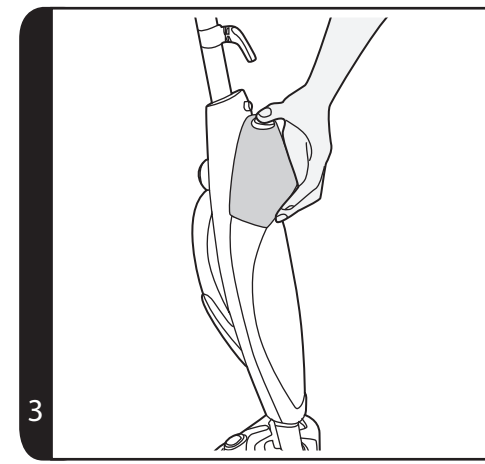
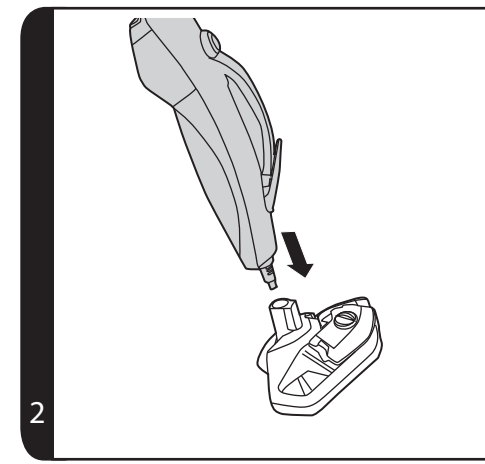
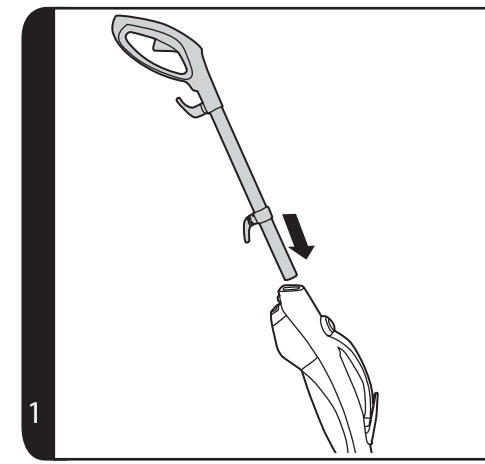



## INSTRUCTIONS FOR SAFE USE

This appliance should only be used for domestic cleaning, as described in this user guide. Please ensure that this guide is fully understood before operating the appliance.

Do not leave the appliance plugged in. Always switch off and remove the plug from the socket after use, or before cleaning the appliance or any maintenance task.

This appliance can be used by persons with reduced physical, sensory or mental capabilities or lack of experience and knowledge if they have been given supervision or instruction concerning use of the appliance in a safe way and understand the hazards involved. Children shall not play with the appliance.

Keep the appliance out of reach of children when it is energized or cooling down.

The appliance is not to be used if it has been dropped, if there are visible signs of damage or if it is leaking.

If the power cord is damaged stop using the appliance immediately. To avoid a safety hazard, an authorised Hoover service engineer must replace the power cord.

This appliance must be earthed.

The appliance shall not be left unattended while it is connected to the supply mains.

Do not use your appliance out of doors.

Use only attachments, consumables or spares recommended or supplied by Hoover.

Do not use the appliance to clean or direct steam towards animals, people or plants.

Liquid or steam must not be directed towards equipment containing electrical components, such as the interior of ovens.

Unplug the cleaner and switch off before filling the water container. Do not fill over the MAX mark. The filling aperture must not be opened during use.



Danger of Scalding.



Surfaces are liable to get very hot during use. Avoid contact with steam.

Do not stand on or wrap the cord around arms or legs when using your appliance.

Do not position the appliance above you when cleaning the stairs.

When using the cleaning tools ensure to always steady the appliance with your other hand. This will ensure that the appliance does not fall while in use.

Do not handle the plug or appliance with wet hands.

Do not run over the power cord when using your appliance or remove the plug by pulling on the power cord.

Do not continue to use your appliance if it appears faulty.

**Hoover service:** To ensure the continued safe and efficient operation of this appliance we recommend that any servicing or repairs are only carried out by an authorised Hoover service engineer.

Do not immerse the appliance in water or other liquids.

Do not use detergents or liquids other than water inside the appliance.

**For UK and Ireland only:** This appliance has a 13 Amp mains plug. If you need to change the fuse in the mains plug, use a 13Amp ASTA (BS1362) fuse.

### The Environment

The symbol on this appliance indicates that this appliance may not be treated as household waste. Instead it must be handed over to the applicable collection point for the recycling of electrical and electronic equipment. Disposal must be carried out in accordance with local environmental regulations for waste disposal. For more detailed information about treatment, recovery and recycling of this appliance, please contact your local city office, your household and waste disposal service or the shop where you purchased the appliance.



**CE** This appliance complies with the European Directives 2006/95/EC, 2004/108/EC and 2011/65/EU.

HOOVER Limited, Pentrebach, Merthyr Tydfil, Mid Glamorgan, CF48 4TU, UK



## GETTING TO KNOW YOUR CLEANER

- A. Steam Trigger Button
- B. Handle
- C. Power Cord
- D. Power Switch
- E. Handheld Carry Handle
- F. Steam Trigger Button (Handheld)
- G. Solution Tank Pedal
- H. Solution Tank Cap
- I. Solution Tank
- J. Cord Hook
- K. Handle Release Button
- L. Water Tank Release Button
- M. Water Tank
- N. Floor Head
- O. Brush
- P. Hose Adapter
- Q. Hose
- R. Conic Tool
- S. Textile Pad
- T. Carpet Glider
- U. Small Cloth
- V. Window squeegee / Upholstery Tool ( with Small Cloth)
- W1. Metal Brush
- W2. Angled Nozzle
- W3. Small Round Brush
- W4. Large Round Brush
- W5. Scraper Tool
- W6. Comb Brush

## ASSEMBLING YOUR CLEANER

Remove all components from the packaging.

1. Insert the handle into the cleaner main body until it locks into position. [1]
2. Assemble the main body of the cleaner to the Floor Head. [2]

## USING YOUR CLEANER

### BEFORE YOU BEGIN CLEANING

1. Remove the clean Water Tank by pressing the Water Tank Release Button. [3]

**NOTE:** The tube which transfers water from the Water Tank to the boiler is weighted down with a brass ball. This is an intentional design to improve efficiency of water usage. It is normal for this ball to create a rattling sound inside the Water Tank during use.

2. Pull the tab on the Water Tank to open. [4]
3. Fill the clean Water Tank with cold tap water. Replace the tab. [4] Do not add any chemicals, detergents or perfumes to the clean Water Tank.

**NOTE:** In order to significantly reduce mineral build-up and prolong the life of your steam mop the use of distilled or de-mineralized water in the unit is highly recommended.

4. Re-fit the clean Water Tank to the cleaner ensuring the hard water filter is in place.
5. Attach a Textile Pad to the base of the Floor Head. [5]

**IMPORTANT:** Always unplug the cleaner when adding water or changing a Textile Pad.

**NOTE:** Wash the Textile Pad prior to use to remove any lint.

### STEAM CLEANING HARD FLOORS

**NOTE:** Always sweep or vacuum the floor prior to use to remove any loose dirt or debris.

**IMPORTANT:** Do not use the cleaner without a Textile Pad attached to the Floor Head.

**NOTE:** Do not use the Carpet Glider when cleaning hard floors.

1. Plug the steam cleaner into the main power. Press the power switch, the blue ON light will illuminate.
2. After a few seconds half of the light will turn to red, indicating the cleaner is ready for use.
3. Recline the cleaner by placing a foot on the Floor Head and lowering the main body towards the floor. [6]
4. To produce steam press the Steam Trigger Button. [7]
5. Move the cleaner slowly backwards and forwards paying particular attention to high traffic areas. [7]

### REFRESHING CARPETS

**NOTE:** Always sweep or vacuum the floor prior to use to remove any loose dirt or debris.

**IMPORTANT:** Do not use the cleaner without a Textile Pad attached to the Floor Head.

1. Attach the Carpet Glider to the Floor Head. [10]
2. Plug the steam cleaner into the main power. Press the power switch, the blue ON light will illuminate.

3. After a few seconds half of the light will turn to red, indicating the cleaner is ready for use.
4. Recline the cleaner by placing a foot on the Floor Head and lowering the main body towards the floor. [6]
5. To produce steam press the Steam Trigger Button. [7]
6. Move the cleaner slowly backwards and forwards paying particular attention to high traffic areas. [7]

## METHODS OF USE FOR HANDHELD STEAM CLEANER

1. Press the Handle Release Button and remove the steel tube[11]
  2. Remove the Floor Head.[12]
  3. Remove the clean water tank by pressing the Water Tank Release Button. [3]
- NOTE:** The tube which transfers water from the Water Tank to the boiler is weighted down with a brass ball. This is an intentional design to improve efficiency of water usage. It is normal for this ball to create a rattling sound inside the Water Tank during use.
4. Pull the tab on the Water Tank to open. [4]
  5. Fill the clean water tank with cold tap water. Replace the tab. [4 ]Do not add any chemicals, detergents or perfumes to the clean water tank.
- NOTE:** In order to significantly reduce mineral build-up and prolong the life of your steam mop the use of distilled or de-mineralized water in the unit is highly recommended.
6. Re-fit the clean Water Tank to the cleaner ensuring the hard water filter is in place.
  7. Plug the steam cleaner into the main power, press the Power Switch then the blue on light will illuminate.
  8. After a few seconds half of the light turn to red and indicating the cleaner is ready for use.
  9. To produce steam press Steam Trigger Button(Handheld).[13]

**IMPORTANT: Always unplug the cleaner when removing the Floor Head or handle. Always ensure the cleaner has fully cooled down before removing the Floor Head.**

## METHODS OF USING SOLUTION TANK

1. Twist Solution Tank Cap counter-clockwise to open and fill in solution fluid.[8]
2. Put back Solution Tank Cap clockwise and secure.
3. Push Solution Tank Pedal ON to use the solution. Push Solution Tank Pedal OFF to stop using the solution.[9]

**WARNING:** Use only Hoover solution. Using other solution brands may cause damage and will prevent the cleaner from working effectively. Using other solutions may affect your warranty.

**IMPORTANT:** To prevent solution leakage ensure the Solution Tank Pedal is in the off position when the product is not in use.

### Empty the solution tank

1. Unplug the cleaner from the main power and ensure the unit has cooled
2. Remove the Solution Tank from the main body of the cleaner. [17]

3. Twist Solution Tank Cap counter-clockwise and remove.
4. Empty any excess solution from the tank. [17] Replace the cap and return to the cleaner.

## ACCESSORIES

### Without hose

1. After removing the Floor Head, accessories can directly attach to the steam outlet of the product.[14] Insert and rotate clockwise until it is locked in position and secure

### With hose

1. Fit the Hose Adapter to steam outlet of the product. [15]
2. Fit the Hose over the Hose Adapter on the product. Align the orientation marks with the hole on Hose Adapter and rotate clockwise until hose is locked in position and secure. [15]
3. To remove hose, slide Release Button at the base of Hose away from cleaner and rotate counter-clockwise and gently pull away from cleaner.
4. Attach Conic Tool to the nozzle on the hose. insert and rotate clockwise until Conic Tool is in locked position and secure.
5. Fit other small accessories to Conic Tool, Insert and rotate clockwise until it is locked in position and secure [15]

**Conic Tool** Use on heavily soiled areas such as showers, kitchens.

**Window squeegee** Use on windows and mirrors for a smear free clean.

**Upholstery Tool** Use the upholstery cloth over the window tool for use on sofas and chair fabrics.

**Round Brush** Use on stubborn grease and grime.

**Metal Brush** For oven grills and racks.

**angled Nozzle** For hard to reach areas such as taps etc.

**Scraper Tool** Ideal for dried residue in ovens or defrosting freezers.

## CLEANER MAINTENANCE

**IMPORTANT: ALWAYS ENSURE THE CLEANER HAS FULLY COOLED DOWN BEFORE PERFORMING ANY MAINTENANCE TASKS.**

### Empty the Water Tank

1. Unplug the cleaner from the main power and ensure the unit has cooled.
2. Remove the clean Water Tank from the main body of the cleaner. [3]
3. Remove the Water Tank cap.
4. Empty any excess water from the tank. [16] Replace the cap and return to the cleaner.

### Removing and cleaning the Textile Pad

1. Unplug the cleaner from the main power and ensure the unit has cooled.
2. If necessary remove the Carpet Glider, then peel the Textile Pad from the

**Floor Base.[18]**

- Wash the Textile Pad in a washing machine with a mild detergent at max temperature 40°C.

**IMPORTANT:** Do not use bleach or fabric softener when washing the Textile Pad.

**Replacing the hard water filter**

The cleaner is fitted with a hard water filter. If you live in an area of hard water the filter will discolor over time. Depending on the water hardness and frequency of use the filter should be changed every 6 months.

- Unplug the cleaner from the main power and ensure the unit has cooled.
- Remove the clean Water Tank from the main body of the cleaner. [3]
- Lift the hard water filter out of the cleaner. [19] Replace with new filter.
- Reassemble the clean Water Tank to your cleaner.

**NOTE:** The condition of the filter will affect the cleaner performance.

**TROUBLE SHOOTING**

Should you have a problem with the product, complete this simple user checklist before calling your local Hoover service.

The steam stick will not switch on.

- Check the unit is plugged in.
- Check the power cord

The steam stick is not producing steam.

- There may be no water in the clean Water Tank.
- The tank may not be fitted correctly.

The Textile Pad won't pick up dirt.

- The cleaning pad may already be saturated with dirt and needs to be washed.

Refer to the Maintenance section

**CLEANING FAQs**

**When is steamjet ready?** In approximately 25 seconds.

**Can I use steamjet on all floor surfaces?** On all hard floors like marble, ceramic, stone, linoleum, sealed hardwood floors and parquet.

**Does steamjet emit steam automatically?** No, to produce steam you should press the steam/sweep trigger button under the handle.

**Can I put detergents or other chemicals inside the tank?** No, you would damage the product.

**What if in the city where I live the water is very hard?** You can use filtered water or

you will have to change the filter cassette more often. If you find very weak steam, check steam orifice, you can descale it by inserting small tools into steam orifice if necessary.

**When is it time to change the filter cassette? How do you notice it?** It depends on the water hardness. Normally 6 months. You will notice that the colour of yellow resin inside the filter cassette becomes a bit dull.

**How long will one tank of water last before needing to be refilled?** Approximately 12 minutes if you press continuously the trigger.

**Is the mop washable?** Yes, it can be washed by hand or in the washing machine with a mild detergent at max temperature 40°C. Do not use bleach or fabric softener.

**How often should I replace the mop?** It depends on different factors above all how hard the floor is. The best way to understand when to change the mop is when the mop is still dirty after having washed it or if you notice that it doesn't perform like before.

**IMPORTANT INFORMATION****Hoover spares and Consumables**

Always replace parts with genuine Hoover spares. These are available from your local Hoover dealer or direct from Hoover. When ordering parts always quote your model number.

**Consumables**

Filter Cassette	U74 35601641
Textile Pads (X2)	AC31 35601642
Small Cloths (x3)	AC27 35601392

**Hoover Customer Helpline Service**

Should any faults occur with your cleaner during the first 12 months, contact the Hoover Customer Helpline on the number below.

**Tel: 08444 995 599**

**Email: [customer.services@hoovercandy.com](mailto:customer.services@hoovercandy.com)**

**Quality**

Hoover's factories have been independently assessed for quality. Our products are made using a quality system which meets the requirements of ISO 9001

**Your Guarantee**

The guarantee conditions for this appliance are as defined by our representative in the country in which it is sold. Details regarding these conditions can be obtained from the dealer from whom the appliance was purchased. The bill of sale or receipt must be produced when making any claim under the terms of this guarantee.

Subject to change without notice.

